

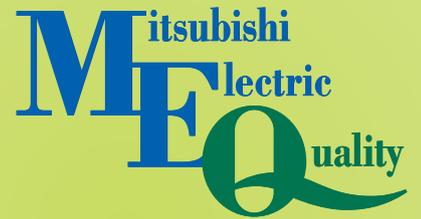

Changes for the Better

AIR TO WATER HEAT PUMP SYSTEMS



ecodan
Renewable Heating Technology

DATA BOOK

Vol.4

for a greener tomorrow



Contents

Outdoor unit..... A-1

Outdoor unit

Cylinder unit / Hydrobox B-1

Cylinder / Hydrobox

Flow temp. controller..... C-1

Flow temp. controller

Optional parts D-1

Optional parts

When installing or relocating, or servicing the heat pump, use only the specified refrigerant (R410A) to charge the refrigerant lines. Do not mix it with any other refrigerant and do not allow air to remain in the lines. If air is mixed with the refrigerant, then it can be the cause of abnormal high pressure in the refrigerant line, and may result in an explosion and other hazards. The use of any refrigerant other than that specified for the system will cause mechanical failure or system malfunction or unit breakdown. In the worst case, this could lead to a serious impediment to securing product safety.

1	Specifications	A-2
1.1	Outdoor unit specifications.....	A-2
1.2	Capacity	A-21
1.3	Maximum outlet water temperature	A-30
1.4	Available range (Water flow rate, return water temp.)....	A-36
2	Outlines and dimensions	A-42
2.1	Packaged-type units	A-42
2.2	Split-type units	A-46
3	Wiring diagrams.....	A-56
3.1	Packaged-type units	A-56
3.2	Split-type units	A-63
4	Refrigerant system diagrams	A-81
4.1	Packaged-type units	A-82
4.2	Split-type units	A-85
5	Performance data	A-91
5.1	Cooling performance data.....	A-91
5.2	Heating performance data	A-94
5.3	Part load chart.....	A-108
5.4	Best COP	A-133
5.5	Correcting capacity for changes in the length of refrigerant piping	A-135
6	Noise criterion curves	A-139
6.1	Packaged-type units	A-139
6.2	Split-type units	A-141
7	Estimated noise level based on the distance from Outdoor unit	A-146
8	Earthquake-proof strength analysis	A-150
9	Error code table	A-178
10	Installation location	A-179
10.1	Packaged-type units (Power inverter/Zubadan).....	A-179
10.2	Split-type units (Eco inverter/Power inverter).....	A-183
10.3	Split-type units (Mr.SLIM+).....	A-188
10.4	Split-type units (Zubadan).....	A-190
10.5	Split-type units (Inverter Multi)	A-194

1.1 Outdoor unit specifications

(1) Packaged-type units

■ Power inverter

Model Name			PUHZ-W50VHA2(-BS)	PUHZ-W85VHA2(-BS)	PUHZ-W112VHA(-BS)
Power supply (phase, cycle, voltage)			1φ, 230V, 50Hz	1φ, 230V, 50Hz	1φ, 230V, 50Hz
Max. current	A		13.0	23.0	29.5
Breaker size	A		16	25	32
Outer casing			Galvanized plate	Galvanized plate	Galvanized plate
External finish			Munsell 3Y 7.8/1.1	Munsell 3Y 7.8/1.1	Munsell 3Y 7.8/1.1
Refrigerant control			Linear expansion valve	Linear expansion valve	Linear expansion valve
Compressor			Hermetic twin rotary	Hermetic twin rotary	Hermetic scroll
Model			SNB130FGCMC	TNB220FLHM1T	ANB33FNMMT
Motor output	kW		0.9	1.3	2.5
Start type			Inverter	Inverter	Inverter
Protection devices			HP switch Discharge thermo Comp. Surface thermo Orver current detection	HP switch Discharge thermo Comp. Surface thermo Orver current detection	HP switch LP switch Discharge thermo Comp. Surface thermo Orver current detection
Oil (Model)	L		0.35 (FV50S)	0.67 (FV50S)	0.9 (FV50S)
Crankcase heater			-	-	-
Heat exchanger	Air		Plate fin coil	Plate fin coil	Plate fin coil
	Water		Plate heat exchanger	Plate heat exchanger	Plate heat exchanger
Fan	Fan(drive) x No.		Propeller fan x 1	Propeller fan x 1	Propeller fan x 2
	Fan motor output	kW	0.086	0.074	0.074 x 2
	Air flow	m ³ /min (CFM)	50 (1,760)	49 (1,730)	100 (3,530)
Defrost method			Reverse cycle	Reverse cycle	Reverse cycle
Noise level (SPL)	Heating	dB(A)	46	48	53
	Cooling	dB(A)	48	48	53
Noise level (PWL)	Heating	dB(A)	61	66	69
Dimensions	Width	mm(in)	950 (37-3/8)	950 (37-3/8)	1020 (40-3/16)
	Depth	mm(in)	330+30 (13+1-3/16)	330+30 (13+1-3/16)	330+30 (13+1-3/16)
	Height	mm(in)	740 (29-3/16)	943 (37-1/8)	1350 (53-1/8)
Weight		kg(lbs)	64 (141)	79 (174)	133 (294)
Refrigerant (GWP)			R410A (1975)	R410A (1975)	R410A (1975)
	Quantity	kg(lbs)	1.7 (3.7)	2.4 (5.3)	4.0 (8.8)
Pipe size O.D.	Liquid	mm(in)	-	-	-
	Gas	mm(in)	-	-	-
Connection method			-	-	-
Between the indoor & outdoor unit	Height difference	m	-	-	-
	Piping length	m	-	-	-
Guaranteed operating range (Outdoor)	Heating	°C	-15 to +21	-20 to +21	-20 to +21
	DHW	°C	-15 to +35	-20 to +35	-20 to +35
	Cooling*	°C	-5 to +46	-5 to +46	-5 to +46
Outlet water temp. (Max in heating, Min in cooling)	Heating	°C	+60	+60	+60
	Cooling	°C	+5	+5	+5
Nominal return water temperature range	Heating	°C	+9 to +59	+9 to +59	+11 to +59
	Cooling	°C	+8 to +28	+8 to +28	+8 to +28
Water flow rate range			L/min	6.5 to 14.3	10.8 to 25.8
				10.8 to 25.8	14.4 to 32.1

* Optional air protection guide is required where ambient temperature is lower than -5°C.
The temperature is 10°C when the unit is connected with Cylinder unit or Hydrobox.
For more details, refer to "Cylinder unit / Hydrobox".

Model Name			PUHZ-W85VAA	PUHZ-W85YAA
Power supply (phase, cycle, voltage)			1φ, 230V, 50Hz	3φ, 400V, 50Hz
	Max. current	A	22.0	11.5
Breaker size		A	25	16
Outer casing			Galvanized plate	Galvanized plate
External finish			Munsell N8.75 Munsell N2.75 (FRONT PANEL)	Munsell N8.75 Munsell N2.75 (FRONT PANEL)
Refrigerant control			Linear expansion valve	Linear expansion valve
Compressor			Hermetic twin rotary	Hermetic twin rotary
	Model		SNB220FEGMC-L1	SNB220FEAMC-L1
	Motor output	kW	1.5	1.5
Start type			Inverter	Inverter
Protection devices			HP switch Discharge thermo Comp. Surface thermo Over current detection	HP switch Discharge thermo Comp. Surface thermo Over current detection
	Oil (Model)	L	0.60 (FV50S)	0.60 (FV50S)
Crankcase heater		W	-	-
Heat exchanger	Air		Plate fin coil	Plate fin coil
	Water		Plate heat exchanger	Plate heat exchanger
Fan	Fan(drive) x No.		Propeller fan ×1	Propeller fan ×1
	Fan motor output	kW	0.074	0.074
	Air flow	m ³ /min (CFM)	44 (1,550)	44 (1,550)
Defrost method			Reverse cycle	Reverse cycle
Noise level (SPL)	Heating	dB(A)	45	45
	Cooling	dB(A)	45	45
Noise level (PWL)	Heating	dB(A)	58	58
Dimensions	Width	mm(in)	1050 (41-5/16)	1050 (41-5/16)
	Depth	mm(in)	480 (18-7/8)	480 (18-7/8)
	Height	mm(in)	1020 (40-3/16)	1020 (40-3/16)
Weight		kg(lbs)	97 (214)	110 (243)
Refrigerant (GWP)			R410A	R410A
	Quantity	kg(lbs)	2.4 (5.3)	2.4 (5.3)
Pipe size O.D.	Liquid	mm(in)	-	-
	Gas	mm(in)	-	-
Connection method			-	-
Between the indoor & outdoor unit	Height difference	m	-	-
	Piping length	m	-	-
Guaranteed operating range (Outdoor)	Heating	°C	-20 to +35	-20 to +35
	Cooling*	°C	-5 to +46	-5 to +46
Outlet water temp. (Max in heating, Min in cooling)	Heating	°C	+60	+60
	Cooling	°C	+5	+5
Nominal return water temperature range	Heating	°C	+9 to +59	+9 to +59
	Cooling	°C	+8 to +28	+8 to +28
Water flow rate range		L/min	10.8 to 25.8	10.8 to 25.8

* Optional air protection guide is required where ambient temperature is lower than -5°C.
The temperature is 10°C when the unit is connected with Cylinder unit or Hydrobox.
For more details, refer to "Cylinder unit / Hydrobox".

Model Name			PUHZ-W112VAA	PUHZ-W112YAA
Power supply (phase, cycle, voltage)			1φ, 230V, 50Hz	3φ, 400V, 50Hz
	Max. current	A	28.0	13.0
Breaker size			32	16
Outer casing			Galvanized plate	Galvanized plate
External finish			Munsell N8.75 Munsell N2.75 (FRONT PANEL)	Munsell N8.75 Munsell N2.75 (FRONT PANEL)
Refrigerant control			Linear expansion valve	Linear expansion valve
Compressor			Hermetic twin rotary	Hermetic twin rotary
	Model		DNB28FBAMT	DNB28FBBMT
	Motor output	kW	2.2	2.2
	Start type		Inverter	Inverter
	Protection devices		HP switch Discharge thermo Comp. Surface thermo Over current detection	HP switch Discharge thermo Comp. Surface thermo Over current detection
	Oil (Model)	L	1.0 (FVC68D)	1.0 (FVC68D)
Crankcase heater			-	-
Heat exchanger	Air		Plate fin coil	Plate fin coil
	Water		Plate heat exchanger	Plate heat exchanger
Fan	Fan(drive) x No.		Propeller fan ×1	Propeller fan ×1
	Fan motor output	kW	0.2	0.2
	Air flow	m ³ /min (CFM)	50 (1,760)	50 (1,760)
Defrost method			Reverse cycle	Reverse cycle
Noise level (SPL)	Heating	dB(A)	47	47
	Cooling	dB(A)	49	49
Noise level (PWL)	Heating	dB(A)	60	60
Dimensions	Width	mm(in)	1050 (41-5/16)	1050 (41-5/16)
	Depth	mm(in)	480 (18-7/8)	480 (18-7/8)
	Height	mm(in)	1020 (40-3/16)	1020 (40-3/16)
Weight		kg(lbs)	118 (260)	131 (289)
Refrigerant (GWP)			R410A	R410A
	Quantity	kg(lbs)	3.3 (7.3)	3.3 (7.3)
Pipe size O.D.	Liquid	mm(in)	-	-
	Gas	mm(in)	-	-
Connection method			-	-
Between the indoor & outdoor unit	Height difference	m	-	-
	Piping length	m	-	-
Guaranteed operating range (Outdoor)	Heating	°C	-20 to +35	-20 to +35
	Cooling*	°C	-5 to +46	-5 to +46
Outlet water temp. (Max in heating, Min in cooling)	Heating	°C	+60	+60
	Cooling	°C	+5	+5
Nominal return water temperature range	Heating	°C	+9 to +59	+9 to +59
	Cooling	°C	+8 to +28	+8 to +28
Water flow rate range		L/min	14.4 to 32.1	14.4 to 32.1

* Optional air protection guide is required where ambient temperature is lower than -5°C.
The temperature is 10°C when the unit is connected with Cylinder unit or Hydrobox.
For more details, refer to "Cylinder unit / Hydrobox".

■ Zubadan

Model Name			PUHZ-HW112YHA2(-BS)	PUHZ-HW140VHA2(-BS)	PUHZ-HW140YHA2(-BS)
Power supply (phase, cycle, voltage)			3φ, 400V, 50Hz	1φ, 230V, 50Hz	3φ, 400V, 50Hz
	Max. current	A	13.0	35.0	13.0
Breaker size		A	16	40	16
Outer casing			Galvanized plate	Galvanized plate	Galvanized plate
External finish			Munsell 3Y 7.8/1.1	Munsell 3Y 7.8/1.1	Munsell 3Y 7.8/1.1
Refrigerant control			Linear expansion valve	Linear expansion valve	Linear expansion valve
Compressor			Hermetic scroll	Hermetic scroll	Hermetic scroll
	Model		ANB33FJJMT	ANB42FJKMT	ANB42FJJMT
	Motor output	kW	2.5	2.8	2.8
	Start type		Inverter	Inverter	Inverter
	Protection devices		HP switch LP switch Discharge thermo Comp. Surface thermo Orver current detection	HP switch LP switch Discharge thermo Comp. Surface thermo Orver current detection	HP switch LP switch Discharge thermo Comp. Surface thermo Orver current detection
	Oil (Model)	L	0.9 (FV50S)	0.9 (FV50S)	0.9 (FV50S)
Crankcase heater		W	-	-	-
Heat exchanger	Air		Plate fin coil	Plate fin coil	Plate fin coil
	Water		Plate heat exchanger	Plate heat exchanger	Plate heat exchanger
Fan	Fan(drive) x No.		Propeller fan x 2	Propeller fan x 2	Propeller fan x 2
	Fan motor output	kW	0.074 x 2	0.074 x 2	0.074 x 2
	Air flow	m ³ /min (CFM)	100 (3,530)	100 (3,530)	100 (3,530)
Defrost method			Reverse cycle	Reverse cycle	Reverse cycle
Noise level (SPL)	Heating	dB(A)	53	53	53
	Cooling	dB(A)	53	53	53
Noise level (PWL)	Heating	dB(A)	67	67	67
Dimensions	Width	mm(in)	1020 (40-3/16)	1020 (40-3/16)	1020 (40-3/16)
	Depth	mm(in)	330+30 (13+1-3/16)	330+30 (13+1-3/16)	330+30 (13+1-3/16)
	Height	mm(in)	1350 (53-1/8)	1350 (53-1/8)	1350 (53-1/8)
Weight		kg(lbs)	148 (326)	134 (296)	148 (326)
Refrigerant (GWP)			R410A (1975)	R410A (1975)	R410A (1975)
	Quantity	kg(lbs)	4.0 (8.8)	4.3 (9.5)	4.3 (9.5)
Pipe size O.D.	Liquid	mm(in)	-	-	-
	Gas	mm(in)	-	-	-
Connection method			-	-	-
Between the indoor & outdoor unit	Height difference	m	-	-	-
	Piping length	m	-	-	-
Guaranteed operating range (Outdoor)	Heating	°C	-25 to +21	-25 to +21	-25 to +21
	DHW	°C	-25 to +35	-25 to +35	-25 to +35
	Cooling*	°C	-5 to +46	-5 to +46	-5 to +46
Outlet water temp. (Max in heating, Min in cooling)	Heating	°C	+60	+60	+60
	Cooling	°C	+5	+5	+5
Nominal return water temperature range	Heating	°C	+11 to +59	+10 to +59	+10 to +59
	Cooling	°C	+8 to +28	+8 to +28	+8 to +28
Water flow rate range		L/min	14.4 to 32.1	17.9 to 40.1	17.9 to 40.1

* Optional air protection guide is required where ambient temperature is lower than -5°C.
The temperature is 10°C when the unit is connected with Cylinder unit or Hydrobox.
For more details, refer to "Cylinder unit / Hydrobox".

(2) Split-type units

■ Power inverter

Model Name			SUHZ-SW45VA	SUHZ-SW45VAH
Power supply (phase, cycle, voltage)			1φ, 230V, 50Hz	1φ, 230V, 50Hz
	Max. current	A	12.0	12.0
Breaker size		A	20	20
Outer casing			Galvanized plate	Galvanized plate
External finish			Munsell 3Y 7.8/1.1	Munsell 3Y 7.8/1.1
Refrigerant control			Linear expansion valve	Linear expansion valve
Compressor			Hermetic twin rotary	Hermetic twin rotary
	Model		SNB130FGBMT	SNB130FGBMT
	Motor output	kW	0.9	0.9
	Start type		Inverter	Inverter
	Protection devices		Discharge thermo Over current	Discharge thermo Over current
	Oil (Model)	L	0.35(FV50S)	0.35(FV50S)
Crankcase heater		W	-	-
Base heater		W	-	120
Heat exchanger	Air		Plate fin coil	Plate fin coil
	Water		Plate heat exchanger	Plate heat exchanger
Fan	Fan(drive) x No.		Propeller fan x 1	Propeller fan x 1
	Fan motor output	kW	0.060	0.060
	Air flow	m ³ /min(CFM)	44.6 (1,575)	44.6 (1,575)
Defrost method			Reverse cycle	Reverse cycle
Noise level (SPL)	Heating	dB(A)	52	52
	Cooling	dB(A)	52	52
Noise level (PWL)	Heating	dB(A)	61	61
Dimensions	Width	mm(in)	840 (33-1/16)	840 (33-1/16)
	Depth	mm(in)	330 (13)	330 (13)
	Height	mm(in)	880 (34-5/8)	880 (34-5/8)
Weight		kg(lbs)	54 (119)	54 (119)
Refrigerant (GWP)			R410A (1975)	R410A (1975)
	Quantity	kg(lbs)	1.3 (2.8)	1.3 (2.8)
Pipe size O.D.	Liquid	mm(in)	6.35 (1/4)	6.35 (1/4)
	Gas	mm(in)	12.7 (1/2)	12.7 (1/2)
Connection method			Flared	Flared
Between the indoor & outdoor unit	Height difference	m	Max. 30	Max. 30
	Piping length	m	2 to 30	2 to 30
Guaranteed operating range (Outdoor)	Heating	°C	-15 to +24	-15 to +24
	DHW	°C	-15 to +35	-15 to +35
	Cooling	°C	+10 to +46	+10 to +46
Outlet water temp. (Max in heating, Min in cooling)	Heating	°C	+55	+55
	Cooling	°C	+5	+5
Nominal return water temperature range	Heating	°C	+5 to +54	+5 to +54
	Cooling	°C	+8 to +28	+8 to +28
Water flow rate range		L/min	7.1 to 12.9	7.1 to 12.9

Model Name			PUHZ-SW50VKA(-BS)
Power supply (phase, cycle, voltage)			1φ, 230V, 50Hz
	Max. current	A	13.0
Breaker size			A 16
Outer casing			Galvanized plate
External finish			Munsell 3Y 7.8/1.1
Refrigerant control			Linear expansion valve
Compressor			Hermetic twin rotary
	Model		SNB130FTCM2
	Motor output	kW	0.9
	Start type		Inverter
	Protection devices		HP switch Discharge thermo Comp. Surface thermo Over current detection
	Oil (Model)	L	0.5(FV50S)
Crankcase heater			W -
Heat exchanger	Air		Plate fin coil
	Water		-
Fan	Fan(drive) x No.		Propeller fan
	Fan motor output	kW	0.046
	Air flow	m ³ /min(CFM)	45 (1,590)
Defrost method			Reverse cycle
Noise level (SPL)	Heating	dB(A)	46
	Cooling	dB(A)	46
Noise level (PWL)	Heating	dB(A)	63
Dimensions	Width	mm(in)	809+62 (31-13/16+2-7/16)
	Depth	mm(in)	300 (11-3/16)
	Height	mm(in)	630 (24-13/16)
Weight			kg(lbs) 43 (95)
Refrigerant (GWP)			R410A (1975)
	Quantity	kg(lbs)	1.4 (3.1)
Pipe size O.D.	Liquid	mm(in)	6.35 (1/4)
	Gas	mm(in)	12.7 (1/2)
Connection method			Flared
Between the indoor & outdoor unit	Height difference	m	Max. 30
	Piping length	m	2 to 40
Guaranteed operating range (Outdoor)	Heating	°C	-15 to +21
	DHW	°C	-15 to +35
	Cooling*	°C	-15 to +46
Outlet water temp. (Max in heating, Min in cooling)	Heating	°C	+60
	Cooling	°C	+5
Nominal return water temperature range	Heating	°C	+5 to +59
	Cooling	°C	+8 to +28
Water flow rate range			L/min 6.5 to 17.2

* Optional air protection guide is required where ambient temperature is lower than -5°C. The temperature is 10°C when the unit is connected with Cylinder unit or Hydrobox. For more details, refer to "Cylinder unit / Hydrobox".

1 Specifications

Outdoor unit

Outdoor unit

Model Name			PUHZ-SW75VHA(-BS)	PUHZ-SW100VHA(-BS)	PUHZ-SW100YHA(-BS)
Power supply (phase, cycle, voltage)			1φ, 230V, 50Hz	1φ, 230V, 50Hz	3φ, 400V, 50Hz
	Max. current	A	17.0	29.5	13.0
Breaker size			25	32	16
Outer casing			Galvanized plate	Galvanized plate	Galvanized plate
External finish			Munsell 3Y 7.8/1.1	Munsell 3Y 7.8/1.1	Munsell 3Y 7.8/1.1
Refrigerant control			Linear expansion valve	Linear expansion valve	Linear expansion valve
Compressor			Hermetic twin rotary	Hermetic scroll	Hermetic scroll
	Model		SNB220FAGMC-L1	ANB33FNEMT	ANB33FNDMT
	Motor output	kW	1.5	2.5	2.5
	Start type		Inverter	Inverter	Inverter
	Protection devices		HP switch Discharge thermo Comp. Surface thermo Over current detection	HP switch LP switch Discharge thermo Comp. Surface thermo Over current detection	HP switch LP switch Discharge thermo Comp. Surface thermo Over current detection
	Oil (Model)	L	0.60 (FV50S)	1.40 (FV50S)	1.40 (FV50S)
Crankcase heater			-	-	-
Heat exchanger		Air	Plate fin coil	Plate fin coil	Plate fin coil
		Water	-	-	-
Fan	Fan(drive) x No.		Propeller fan	Propeller fan ×2	Propeller fan ×2
	Fan motor output	kW	0.074	0.074 ×2	0.074 ×2
	Air flow	m ³ /min (CFM)	55 (1,940)	100 (3,353)	100 (3,353)
Defrost method			Reverse cycle	Reverse cycle	Reverse cycle
Noise level (SPL)	Heating	dB(A)	51	54	54
	Cooling	dB(A)	48	50	50
Noise level (PWL)	Heating	dB(A)	68	70	70
Dimensions	Width	mm(in)	950 (37-13/32)	950 (37-13/32)	950 (37-13/32)
	Depth	mm(in)	330+30 (13+1-3/16)	330+30 (13+1-3/16)	330+30 (13+1-3/16)
	Height	mm(in)	943 (37-1/8)	1350 (53-1/8)	1350 (53-1/8)
Weight		kg(lbs)	75 (166)	118(261)	130 (287)
Refrigerant (GWP)			R410A (1975)	R410A (1975)	R410A (1975)
	Quantity	kg(lbs)	3.2(7.0)	4.6 (10.2)	4.6 (10.1)
Pipe size O.D.	Liquid	mm(in)	9.52 (3/8)	9.52 (3/8)	9.52 (3/8)
	Gas	mm(in)	15.88 (5/8)	15.88 (5/8)	15.88 (5/8)
Connection method			Flared	Flared	Flared
Between the indoor & outdoor unit	Height difference	m	Max. 30	Max. 30	Max. 30
	Piping length	m	2 to 40	2 to 75	2 to 75
Guaranteed operating range (Outdoor)	Heating	°C	-20 to +21	-20 to +21	-20 to +21
	DHW	°C	-20 to +35	-20 to +35	-20 to +35
	Cooling*	°C	-15 to +46	-15 to +46	-15 to +46
Outlet water temp. (Max in heating, Min in cooling)	Heating	°C	+60	+60	+60
	Cooling	°C	+5	+5	+5
Nominal return water temperature range	Heating	°C	+11 to +59	+10 to +59	+10 to +59
	Cooling	°C	+8 to +28	+8 to +28	+8 to +28
Water flow rate range		L/min	9.5 to 22.9	13.0 to 32.1	13.0 to 32.1

* Optional air protection guide is required where ambient temperature is lower than -5°C.
The temperature is 10°C when the unit is connected with Cylinder unit or Hydrobox.
For more details, refer to "Cylinder unit / Hydrobox".

Model Name			PUHZ-SW120VHA(-BS)	PUHZ-SW120YHA(-BS)
Power supply (phase, cycle, voltage)			1φ, 230V, 50Hz	3φ, 400V, 50Hz
	Max. current	A	29.5	13.0
Breaker size		A	40	16
Outer casing			Galvanized plate	Galvanized plate
External finish			Munsell 3Y 7.8/1.1	Munsell 3Y 7.8/1.1
Refrigerant control			Linear expansion valve	Linear expansion valve
Compressor			Hermetic scroll	Hermetic scroll
	Model		ANB42FNEMT	ANB42FNDMT
	Motor output	kW	2.5	2.5
	Start type		Inverter	Inverter
	Protection devices		HP switch LP switch Discharge thermo Comp. Surface thermo Over current detection	HP switch LP switch Discharge thermo Comp. Surface thermo Over current detection
	Oil (Model)	L	1.40 (FV50S)	1.40 (FV50S)
Crankcase heater		W	-	-
Heat exchanger		Air	Plate fin coil	Plate fin coil
		Water	-	-
Fan	Fan(drive) x No.		Propeller fan ×2	Propeller fan ×2
	Fan motor output	kW	0.074 ×2	0.074 ×2
	Air flow	m ³ /min (CFM)	100 (3,353)	100 (3,353)
Defrost method			Reverse cycle	Reverse cycle
Noise level (SPL)	Heating	dB(A)	54	54
	Cooling	dB(A)	51	51
Noise level (PWL)	Heating	dB(A)	72	72
Dimensions	Width	mm(in)	950 (37-13/32)	950 (37-13/32)
	Depth	mm(in)	330+30 (13+1-3/16)	330+30 (13+1-3/16)
	Height	mm(in)	1350 (53-1/8)	1350 (53-1/8)
Weight		kg(lbs)	118 (261)	130 (287)
Refrigerant (GWP)			R410A (1975)	R410A (1975)
	Quantity	kg(lbs)	4.6 (10.2)	4.6 (10.2)
Pipe size O.D.	Liquid	mm(in)	9.52 (3/8)	9.52 (3/8)
	Gas	mm(in)	15.88 (5/8)	15.88 (5/8)
Connection method			Flared	Flared
Between the indoor & outdoor unit	Height difference	m	Max. 30	Max. 30
	Piping length	m	2 to 75	2 to 75
Guaranteed operating range (Outdoor)	Heating	°C	-20 to +21	-20 to +21
	DHW	°C	-20 to +35	-20 to +35
	Cooling*	°C	-15 to +46	-15 to +46
Outlet water temp. (Max in heating, Min in cooling)	Heating	°C	+60	+60
	Cooling	°C	+5	+5
Nominal return water temperature range	Heating	°C	+10 to +59	+10 to +59
	Cooling	°C	+8 to +28	+8 to +28
Water flow rate range		L/min	17.9 to 45.9	17.9 to 45.9

* Optional air protection guide is required where ambient temperature is lower than -5°C.
The temperature is 10°C when the unit is connected with Cylinder unit or Hydrobox.
For more details, refer to "Cylinder unit / Hydrobox".

Model Name			PUHZ-SW160YKA(-BS)	PUHZ-SW200YKA(-BS)
Power supply (phase, cycle, voltage)			3φ, 400V, 50Hz	3φ, 400V, 50Hz
	Max. current	A	19.0	21.0
Breaker size			25	32
Outer casing			Galvanized plate	Galvanized plate
External finish			Munsell 3Y 7.8/1.1	Munsell 3Y 7.8/1.1
Refrigerant control			Linear expansion valve	Linear expansion valve
Compressor			Hermetic scroll	Hermetic scroll
	Model		ANB52FRNMT	ANB52FRNMT
	Motor output	kW	4.7	4.7
	Start type		Inverter	Inverter
	Protection devices		HP switch Comp. Surface thermo HP sensor	HP switch Comp. Surface thermo HP sensor
	Oil (Model)	L	2.30 (FV50S)	2.30 (FV50S)
Crankcase heater			W	-
Heat exchanger		Air	Plate fin coil	Plate fin coil
		Water	-	-
Fan	Fan(drive) x No.		Propeller fan ×2	Propeller fan ×2
	Fan motor output	kW	0.200 ×2	0.200 ×2
	Air flow	m ³ /min (CFM)	140 (4,940)	140 (4,940)
Defrost method			Reverse cycle	Reverse cycle
Noise level (SPL)	Heating	dB(A)	62	62
	Cooling	dB(A)	58	60
Noise level (PWL)	Heating	dB(A)	78	78
Dimensions	Width	mm(in)	1050 (41-5/16)	1050 (41-5/16)
	Depth	mm(in)	330+40 (13+1-9/16)	330+40 (13+1-9/16)
	Height	mm(in)	1338 (52-11/16)	1338 (52-11/16)
Weight		kg(lbs)	136 (300)	136 (300)
Refrigerant (GWP)			R410A (1975)	R410A (1975)
	Quantity	kg(lbs)	7.1 (15.7)	7.7 (17.0)
Pipe size O.D.	Liquid	mm(in)	9.52 (3/8)	12.7 (1/2)
	Gas	mm(in)	25.4 (1)	25.4 (1)
Connection method			Flared	Flared
Between the indoor & outdoor unit	Height difference	m	Max. 30	Max. 30
	Piping length	m	2 to 80	2 to 80
Guaranteed operating range (Outdoor)	Heating	°C	-20 to +21	-20 to +21
	DHW	°C	-20 to +35	-20 to +35
	Cooling*	°C	-15 to +46	-15 to +46
Outlet water temp. (Max in heating, Min in cooling)	Heating	°C	+60	+60
	Cooling	°C	+5	+5
Nominal return water temperature range	Heating	°C	+5 to +59	+5 to +59
	Cooling	°C	+8 to +28	+8 to +28
Water flow rate range		L/min	23.0 to 63.1	28.7 to 71.7

* Optional air protection guide is required where ambient temperature is lower than -5°C.
The temperature is 10°C when the unit is connected with Cylinder unit or Hydrobox.
For more details, refer to "Cylinder unit / Hydrobox".

Model Name			PUHZ-SW75VAA(-BS)	PUHZ-SW75YAA(-BS)
Power supply (phase, cycle, voltage)			1φ, 230V, 50Hz	3φ, 400V, 50Hz
	Max. current	A	22.0	11.5
Breaker size		A	25.0	16.0
Outer casing			Galvanized plate	Galvanized plate
External finish			Munsell: N8.75 Munsell N2.75 (FRONT PANEL)	Munsell: N8.75 Munsell N2.75 (FRONT PANEL)
Refrigerant control			Linear expansion valve	Linear expansion valve
Compressor			Hermetic scroll	Hermetic scroll
	Model		SNB220FEGMC-L1	SNB220FEAMC-L1
	Motor output	kW	1.5	1.5
	Start type		Inverter	Inverter
	Protection devices		HP switch Comp. surface thermo Discharge thermo Over current detection	HP switch Comp. surface thermo Discharge thermo Over current detection
	Oil (Model)	L	0.60 (FV50S)	0.60 (FV50S)
Crankcase heater		W	-	-
Heat exchanger		Air	Plate fin coil	Plate fin coil
		Water	-	-
Fan	Fan(drive) x No.		Propeller fan ×1	Propeller fan ×1
	Fan motor output	kW	0.074	0.074
	Air flow	m ³ /min (CFM)	44 (1,550)	44 (1,550)
Defrost method			Reverse cycle	Reverse cycle
Noise level (SPL)	Heating	dB(A)	43	43
	Cooling	dB(A)	45	45
Noise level (PWL)	Heating	dB(A)	58	58
Dimensions	Width	mm(in)	1050 (41-5/16)	1050 (41-5/16)
	Depth	mm(in)	480 (18-7/8)	480 (18-7/8)
	Height	mm(in)	1020 (40-3/16)	1020 (40-3/16)
Weight		kg(lbs)	92 (203)	104 (229)
Refrigerant (GWP)			R410A (1975)	R410A (1975)
	Quantity	kg(lbs)	3.0 (6.6)	3.0 (6.6)
Pipe size O.D.	Liquid	mm(in)	9.52(3/8)	9.52(3/8)
	Gas	mm(in)	15.88(5/8)	15.88(5/8)
Connection method			Flared	Flared
Between the indoor & outdoor unit	Height difference	m	Max. 30	Max. 30
	Piping length	m	2 to 40	2 to 40
Guaranteed operating range (Outdoor)	Heating	°C	-20 to +21	-20 to +21
	DHW	°C	-20 to +35	-20 to +35
	Cooling*	°C	-15 to +46	-15 to +46
Outlet water temp. (Max in heating, Min in cooling)	Heating	°C	+60	+60
	Cooling	°C	+5	+5
Nominal return water temperature range	Heating	°C	+5 to +59	+5 to +59
	Cooling	°C	+8 to +28	+8 to +28
Water flow rate range		L/min	10.2 to 22.9	10.2 to 22.9

* Optional air protection guide is required where ambient temperature is lower than -5°C.
The temperature is 10°C when the unit is connected with Cylinder unit or Hydrobox.
For more details, refer to "Cylinder unit / Hydrobox".

Model Name			PUHZ-SW100VAA(-BS)	PUHZ-SW100YAA(-BS)
Power supply (phase, cycle, voltage)			1φ, 230V, 50Hz	3φ, 400V, 50Hz
	Max. current	A	28.0	13.0
Breaker size			32.0	16.0
Outer casing			Galvanized plate	Galvanized plate
External finish			Munsell: N8.75 Munsell N2.75 (FRONT PANEL)	Munsell: N8.75 Munsell N2.75 (FRONT PANEL)
Refrigerant control			Linear expansion valve	Linear expansion valve
Compressor			Hermetic	Hermetic
	Model		DNB28FBAMT	DNB28FBBMT
	Motor output	kW	2.2	2.2
Start type			Inverter	Inverter
Protection devices			HP switch LP switch Comp. surface thermo Discharge thermo Over current detection	HP switch LP switch Comp. surface thermo Discharge thermo Over current detection
	Oil (Model)	L	1.0 (FVC68D)	1.0 (FVC68D)
Crankcase heater			-	-
Heat exchanger		Air	Plate fin coil	Plate fin coil
		Water	-	-
Fan	Fan(drive) x No.		Propeller fan x 1	Propeller fan x 1
	Fan motor output	kW	0.2	0.2
	Air flow	m ³ /min (CFM)	50 (1,760)	50 (1,760)
Defrost method			Reverse cycle	Reverse cycle
Noise level (SPL)	Heating	dB(A)	47	47
	Cooling	dB(A)	49	49
Noise level (PWL)	Heating	dB(A)	60	60
Dimensions	Width	mm(in)	1050 (41-5/16)	1050 (41-5/16)
	Depth	mm(in)	480 (18-7/8)	480 (18-7/8)
	Height	mm(in)	1020 (40-3/16)	1020 (40-3/16)
Weight		kg(lbs)	114 (251)	126 (278)
Refrigerant (GWP)			R410A (1975)	R410A (1975)
	Quantity	kg(lbs)	4.2 (9.2)	4.2 (9.2)
Pipe size O.D.	Liquid	mm(in)	9.52(3/8)	9.52(3/8)
	Gas	mm(in)	15.88(5/8)	15.88(5/8)
Connection method			Flared	Flared
Between the indoor & outdoor unit	Height difference	m	Max. 30	Max. 30
	Piping length	m	2 to 75	2 to 75
Guaranteed operating range (Outdoor)	Heating	°C	-20 to +21	-20 to +21
	DHW	°C	-20 to +35	-20 to +35
	Cooling*	°C	-15 to +46	-15 to +46
Outlet water temp. (Max in heating, Min in cooling)	Heating	°C	+60	+60
	Cooling	°C	+5	+5
Nominal return water temperature range	Heating	°C	+5 to +59	+5 to +59
	Cooling	°C	+8 to +28	+8 to +28
Water flow rate range		L/min	14.4 to 32.1	14.4 to 32.1

* Optional air protection guide is required where ambient temperature is lower than -5°C.
 The temperature is 10°C when the unit is connected with Cylinder unit or Hydrobox.
 For more details, refer to "Cylinder unit / Hydrobox".

Mr.SLIM+

Model Name			PUHZ-FRP71VHA2	
Power supply (phase, cycle, voltage)			1φ, 230V, 50Hz	
	Max. current	A	19.0	
Breaker size			A	25
Outer casing			Galvanized plate	
External finish			Munsell 3Y 7.8/1.1	
Refrigerant control			Linear expansion valve	
Compressor			Hermetic	
	Model	SNB172FSHM1		
	Motor output	kW	1.6	
	Start type	Inverter		
	Protection devices	HP switch Discharge thermo Comp. Surface thermo		
	Oil (Model)	L	0.70 (FV50S)	
Crankcase heater			W	-
Heat exchanger		Air	Plate fin coil	
		Water	-	
Fan	Fan(drive) x No.		Propeller fan x 1	
	Fan motor output		kW	0.086
	Air flow		m ³ /min(CFM)	50 (1,760)
Defrost method			Reverse cycle	
Noise level (SPL)	ATA Cooling HR Cooling		dB	47
	ATA Heating ATW Heating		dB	49
Noise level (PWL)	ATA Cooling HR Cooling		dB	67
	ATA Heating ATW Heating		dB	68
Dimensions	Width	mm(in)	950 (37-3/8)	
	Depth	mm(in)	330+25 (13-7/8)	
	Height	mm(in)	943 (37-1/8)	
Weight		kg(lbs)	73 (161)	
Refrigerant (GWP)			R410A (1975)	
	Quantity	kg(lbs)	3.8 (8.4)	
Pipe size O.D.	ATA	Liquid	mm(in)	9.52 (3/8)
		Gas	mm(in)	15.88 (5/8)
	ATW	Liquid	mm(in)	9.52 (3/8)
		Gas	mm(in)	15.88 (5/8)
Connection method			Flared	
Between the indoor & outdoor unit	Height difference	m	Max. 20	
	Piping length	m	Max. 60m total, Max. 30m for each	
Guaranteed operating range (Outdoor)	ATA Cooling*		°C	-15 to +46
	ATA Heating		°C	-20 to +21
	ATW Heating		°C	-20 to +35
	HR Cooling		°C	+15 to +46
Outlet water temp. (Max in heating)	ATW Heating		°C	+60
Nominal return water temperature range	ATW Heating		°C	+11 to +59
Water flow rate range		L/min	11.5 to 22.9	

* Optional air protection guide is required where ambient temperature is lower than -5°C. The temperature is 10°C when the unit is connected with Cylinder unit or Hydrobox. For more details, refer to "Cylinder unit / Hydrobox".

Zubadan

Model Name			PUHZ-SHW80VHA(-BS)	PUHZ-SHW112VHA(-BS)	PUHZ-SHW112YHA(-BS)
Power supply (phase, cycle, voltage)			1φ, 230V, 50Hz	1φ, 230V, 50Hz	3φ, 400V, 50Hz
Max. current	A		29.5	35.0	13.0
Breaker size			A	32	40
Outer casing			Galvanized plate	Galvanized plate	Galvanized plate
External finish			Munsell 3Y 7.8/1.1	Munsell 3Y 7.8/1.1	Munsell 3Y 7.8/1.1
Refrigerant control			Linear expansion valve	Linear expansion valve	Linear expansion valve
Compressor			Hermetic scroll	Hermetic scroll	Hermetic scroll
Model			ANB33FJRMT	ANB33FJRMT	ANB33FJQMT
Motor output	kW		2.5	2.5	2.5
Start type			Inverter	Inverter	Inverter
Protection devices			HP switch LP switch Discharge thermo Comp. Surface thermo	HP switch LP switch Discharge thermo Comp. Surface thermo	HP switch LP switch Discharge thermo Comp. Surface thermo
Oil (Model)	L		1.40 (FVC68D)	1.40 (FVC68D)	1.40 (FVC68D)
Crankcase heater			W	-	-
Heat exchanger		Air	Plate fin coil	Plate fin coil	Plate fin coil
		Water	-	-	-
Fan		Fan(drive) x No.	Propeller fan ×2	Propeller fan ×2	Propeller fan ×2
		Fan motor output	kW	0.074 ×2	0.074 ×2
		Air flow	m ³ /min (CFM)	100 (3,530)	100 (3,530)
Defrost method			Reverse cycle	Reverse cycle	Reverse cycle
Noise level (SPL)		Heating	dB(A)	51	52
		Cooling	dB(A)	50	51
Noise level (PWL)		Heating	dB(A)	69	70
Dimensions		Width	mm(in)	950 (37-3/8)	950 (37-3/8)
		Depth	mm(in)	330+30 (13+1-3/16)	330+30 (13+1-3/16)
		Height	mm(in)	1350 (53-1/8)	1350 (53-1/8)
Weight			kg(lbs)	120 (265)	134 (296)
Refrigerant (GWP)			R410A (1975)	R410A (1975)	R410A (1975)
		Quantity	kg(lbs)	5.5 (12.1)	5.5 (12.1)
Pipe size O.D.		Liquid	mm(in)	9.52 (3/8)	9.52 (3/8)
		Gas	mm(in)	15.88 (5/8)	15.88 (5/8)
Connection method			Flared	Flared	Flared
Between the indoor & outdoor unit		Height difference	m	Max. 30	Max. 30
		Piping length	m	2 to 75	2 to 75
Guaranteed operating range (Outdoor)		Heating	°C	-28 (*1) to +21	-28 (*1) to +21
		DHW	°C	-28 (*1) to +35	-28 (*1) to +35
		Cooling *2	°C	-15 to +46	-15 to +46
Outlet water temp. (Max in heating, Min in cooling)		Heating	°C	+60	+60
		Cooling	°C	+5	+5
Nominal return water temperature range		Heating	°C	+10 to +59	+10 to +59
		Cooling	°C	+8 to +28	+8 to +28
Water flow rate range			L/min	10.2 to 22.9	14.4 to 32.1

*1 Service reference number from "R2" (before "R2" : -25°C)

*2 Optional air protection guide is required where ambient temperature is lower than -5°C.

The temperature is 10°C when the unit is connected with Cylinder unit or Hydrobox.

For more details, refer to "Cylinder unit / Hydrobox".

Model Name			PUHZ-SHW140YHA(-BS)	PUHZ-SHW230YKA2
Power supply (phase, cycle, voltage)			3φ, 400V, 50Hz	3φ, 400V, 50Hz
	Max. current	A	13.0	26.0
Breaker size			A	16
Outer casing			Galvanized plate	Galvanized plate
External finish			Munsell 3Y 7.8/1.1	Munsell 3Y 7.8/1.1
Refrigerant control			Linear expansion valve	Linear expansion valve
Compressor			Hermetic scroll	Hermetic scroll
	Model		ANB33FJQMT	ANB66FJNMT
	Motor output	kW	2.5	4.7
Start type			Inverter	Inverter
Protection devices			HP switch LP switch Discharge thermo Comp. Surface thermo	HP switch LP switch Discharge thermo Comp. Surface thermo Orver current detection
	Oil (Model)	L	1.40 (FVC68D)	1.70 (FV50S)
Crankcase heater			W	-
Heat exchanger		Air	Plate fin coil	Plate fin coil
		Water	-	-
Fan		Fan(drive) x No.	Propeller fan ×2	Propeller fan ×2
	Fan motor output	kW	0.074 ×2	0.150 ×2
	Air flow	m ³ /min(CFM)	100 (3,530)	140 (4,940)
Defrost method			Reverse cycle	Reverse cycle
Noise level (SPL)		Heating	dB(A)	52
		Cooling	dB(A)	51
Noise level (PWL)		Heating	dB(A)	70
		Cooling	dB(A)	75
Dimensions		Width	mm(in)	950 (37-3/8)
		Depth	mm(in)	330+30 (13+1-3/16)
		Height	mm(in)	1350 (53-1/8)
Weight			kg(lbs)	134 (296)
Refrigerant (GWP)			R410A (1975)	R410A (1975)
	Quantity	kg(lbs)	5.5 (12.1)	7.7 (17.0)
Pipe size O.D.		Liquid	mm(in)	9.52 (3/8)
		Gas	mm(in)	15.88 (5/8)
Connection method			Flared	Flared
Between the indoor & outdoor unit		Height difference	m	Max. 30
		Piping length	m	2 to 75
Guaranteed operating range (Outdoor)		Heating	°C	-28 (*1) to +21
		DHW	°C	-28 (*1) to +35
		Cooling *2	°C	-15 to +46
Outlet water temp. (Max in heating, Min in cooling)		Heating	°C	+60
		Cooling	°C	+5
Nominal return water temperature range		Heating	°C	+10 to +59
		Cooling	°C	+8 to +28
Water flow rate range			L/min	17.9 to 40.1
				28.7 to 65.9

*1 Service reference number from "R2" (before "R2" : -25°C)

*2 Optional air protection guide is required where ambient temperature is lower than -5°C.
The temperature is 10°C when the unit is connected with Cylinder unit or Hydrobox.
For more details, refer to "Cylinder unit / Hydrobox".

Model Name			PUHZ-SHW80VAA(-BS)	PUHZ-SHW80YAA(-BS)
Power supply (phase, cycle, voltage)			1φ, 230V, 50Hz	3φ, 400V, 50Hz
	Max. current	A	22.0	13.0
Breaker size			25.0	16.0
Outer casing			Galvanized plate	Galvanized plate
External finish			Munsell: N8.75 Munsell N2.75 (FRONT PANEL)	Munsell: N8.75 Munsell N2.75 (FRONT PANEL)
Refrigerant control			Linear expansion valve	Linear expansion valve
Compressor			Hermetic scroll	Hermetic scroll
	Model		DNK28FBAMT	DNK28FBBMT
	Motor output	kW	2.2	2.2
Start type			Inverter	Inverter
Protection devices			HP switch LP switch Discharge thermo Overcurrent detection Comp. surface thermo	HP switch LP switch Discharge thermo Overcurrent detection Comp. surface thermo
	Oil (Model)	L	1.00 (FVC68D)	1.00 (FVC68D)
Crankcase heater			-	-
Heat exchanger		Air	Plate fin coil	Plate fin coil
		Water	-	-
Fan	Fan(drive) x No.		Propeller fan x 1	Propeller fan x 1
	Fan motor output	kW	0.2	0.2
	Air flow	m ³ /min (CFM)	50 (1,760)	50 (1,760)
Defrost method			Reverse cycle	Reverse cycle
Noise level (SPL)	Heating	dB(A)	45	45
	Cooling	dB(A)	48	48
Noise level (PWL)	Heating	dB(A)	59	59
Dimensions	Width	mm(in)	1050 (41-5/16)	1050 (41-5/16)
	Depth	mm(in)	480 (18-7/8)	480 (18-7/8)
	Height	mm(in)	1020 (40-3/16)	1020 (40-3/16)
Weight		kg(lbs)	116 (256)	128 (282)
Refrigerant (GWP)			R410A (1975)	R410A (1975)
	Quantity	kg(lbs)	4.6 (10.1)	4.6 (10.1)
Pipe size O.D.	Liquid	mm(in)	9.52 (3/8)	9.52 (3/8)
	Gas	mm(in)	15.88 (5/8)	15.88 (5/8)
Connection method			Flared	Flared
Between the indoor & outdoor unit	Height difference	m	Max. 30	Max. 30
	Piping length	m	2 to 75	2 to 75
Guaranteed operating range (Outdoor)	Heating	°C	-28 to +21	-28 to +21
	DHW	°C	-28 to +35	-28 to +35
	Cooling*	°C	-15 to +46	-15 to +46
Outlet water temp. (Max in heating, Min in cooling)	Heating	°C	+60	+60
	Cooling	°C	+5	+5
Nominal return water temperature range	Heating	°C	+5 to +59	+5 to +59
	Cooling	°C	+8 to +28	+8 to +28
Water flow rate range		L/min	10.2 to 22.9	10.2 to 22.9

* Optional air protection guide is required where ambient temperature is lower than -5°C.
The temperature is 10°C when the unit is connected with Cylinder unit or Hydrobox.
For more details, refer to "Cylinder unit / Hydrobox".

1 Specifications

Outdoor unit

Model Name			PUHZ-SHW112VAA(-BS)	PUHZ-SHW112YAA(-BS)
Power supply (phase, cycle, voltage)			1φ, 230V, 50Hz	3φ, 400V, 50Hz
	Max. current	A	28.0	13.0
Breaker size			32.0	16.0
Outer casing			Galvanized plate	Galvanized plate
External finish			Munsell: N8.75 Munsell N2.75 (FRONT PANEL)	Munsell: N8.75 Munsell N2.75 (FRONT PANEL)
Refrigerant control			Linear expansion valve	Linear expansion valve
Compressor			Hermetic scroll	Hermetic scroll
	Model		DNK28FBAMT	DNK28FBBMT
	Motor output	kW	2.2	2.2
Start type			Inverter	Inverter
Protection devices			HP switch LP switch Discharge thermo Overcurrent detection Comp. surface thermo	HP switch LP switch Discharge thermo Overcurrent detection Comp. surface thermo
	Oil (Model)	L	1.00 (FVC68D)	1.00 (FVC68D)
Crankcase heater			W	-
Heat exchanger		Air	Plate fin coil	Plate fin coil
		Water	-	-
Fan	Fan(drive) x No.		Propeller fan x 1	Propeller fan x 1
	Fan motor output	kW	0.2	0.2
	Air flow	m ³ /min (CFM)	50 (1,760)	50 (1,760)
Defrost method			Reverse cycle	Reverse cycle
Noise level (SPL)	Heating	dB(A)	47	47
	Cooling	dB(A)	49	49
Noise level (PWL)	Heating	dB(A)	60	60
Dimensions	Width	mm(in)	1050 (41-5/16)	1050 (41-5/16)
	Depth	mm(in)	480 (18-7/8)	480 (18-7/8)
	Height	mm(in)	1020 (40-3/16)	1020 (40-3/16)
Weight		kg(lbs)	116 (256)	128 (282)
Refrigerant (GWP)			R410A (1975)	R410A (1975)
	Quantity	kg(lbs)	4.6 (10.1)	4.6 (10.1)
Pipe size O.D.	Liquid	mm(in)	9.52 (3/8)	9.52 (3/8)
	Gas	mm(in)	15.88 (5/8)	15.88 (5/8)
Connection method			Flared	Flared
Between the indoor & outdoor unit	Height difference	m	Max. 30	Max. 30
	Piping length	m	2 to 75	2 to 75
Guaranteed operating range (Outdoor)	Heating	°C	-28 to +21	-28 to +21
	DHW	°C	-28 to +35	-28 to +35
	Cooling*	°C	-15 to +46	-15 to +46
Outlet water temp. (Max in heating, Min in cooling)	Heating	°C	+60	+60
	Cooling	°C	+5	+5
Nominal return water temperature range	Heating	°C	+5 to +59	+5 to +59
	Cooling	°C	+8 to +28	+8 to +28
Water flow rate range		L/min	14.4 to 32.1	14.4 to 32.1

* Optional air protection guide is required where ambient temperature is lower than -5°C.
The temperature is 10°C when the unit is connected with Cylinder unit or Hydrobox.
For more details, refer to "Cylinder unit / Hydrobox".

■ Inverter multi

Model Name			PUMY-P112VKM4(-BS)	PUMY-P125VKM4(-BS)	PUMY-P140VKM4(-BS)
Power supply (phase, cycle, voltage)			1-phase 220-230-240 V, 50 Hz ; 1-phase 220-230 V, 60 Hz		
	Max. current	A	29.5	29.5	29.5
Breaker size		A	40*1	40*1	40*1
Outer casing			Galvanized plate	Galvanized plate	Galvanized plate
External finish			Munsell No. 3Y 7.8/1.1	Munsell No. 3Y 7.8/1.1	Munsell No. 3Y 7.8/1.1
Refrigerant control			Linear expansion valve	Linear expansion valve	Linear expansion valve
Compressor			Hermetic scroll	Hermetic scroll	Hermetic scroll
	Model		ANB33FNHMT	ANB33FNHMT	ANB33FNHMT
	Motor output	kW	2.9	3.5	3.9
Start type			Inverter	Inverter	Inverter
Protection devices			HP switch LP switch Comp. Surface thermo Over Current detection	HP switch LP switch Comp. Surface thermo Over Current detection	HP switch LP switch Comp. Surface thermo Over Current detection
	Oil (Model)	L	2.30 (FV50S)	2.30 (FV50S)	2.30 (FV50S)
Crankcase heater		W	-	-	-
Heat exchanger	Air		Plate fin coil	Plate fin coil	Plate fin coil
	Water		-	-	-
Fan	Fan(drive) x No.		Propeller fan x 2	Propeller fan x 2	Propeller fan x 2
	Fan motor output	kW	0.074 x 2	0.074 x 2	0.074 x 2
	Air flow	m ³ /min (CFM)	110 (3,884)	110 (3,884)	110 (3,884)
Defrost method			Reverse cycle	Reverse cycle	Reverse cycle
Noise level (SPL)	Heating	dB(A)	51	52	53
	Cooling	dB(A)	49	50	51
Noise level (PWL)	Heating	dB(A)	71	72	73
Dimensions	Width	mm(in)	1050 (41-11/32)	1050 (41-11/32)	1050 (41-11/32)
	Depth	mm(in)	330+40(13+1-9/16)	330+40(13+1-9/16)	330+40(13+1-9/16)
	Height	mm(in)	1338 (52-11/16)	1338 (52-11/16)	1338 (52-11/16)
Weight		kg(lbs)	122 (269)	122 (269)	122 (269)
Refrigerant (GWP)			R410A (1975)	R410A (1975)	R410A (1975)
	Quantity	kg(lbs)	4.8 (10.6)	4.8 (10.6)	4.8 (10.6)
Pipe size O.D.	Liquid	mm(in)	9.52 (3/8)	9.52 (3/8)	9.52 (3/8)
	Gas	mm(in)	15.88 (5/8)	15.88 (5/8)	15.88 (5/8)
Connection method			Flared	Flared	Flared
Between the indoor & outdoor unit	Height difference	m	Max. 50*2 Max. 40*3	Max. 50*2 Max. 40*3	Max. 50*2 Max. 40*3
	Piping length	m	Max. 150m total Max. 80m for each	Max. 150m total Max. 80m for each	Max. 150m total Max. 80m for each
Guaranteed operating range (Outdoor)	ATW	Heating	°C (D.B.)	-20 to +21	-20 to +21
		DHW	°C (D.B.)	-20 to +35	-20 to +35
		Cooling	°C (D.B.)	-	-
	ATA	Heating	°C (D.B.)	-20 to +21	-20 to +21
		Cooling *4	°C (D.B.)	-5 to +52	-5 to +52
	ATW+ATA (simultaneous operation)	ATA heating+DHW	°C (D.B.)	7 to +21	7 to +21
ATA heating+ATW heating		°C (D.B.)	-10 to +21	-10 to +21	
Outlet water temp. (Max in heating, Min in cooling)	Heating	ATW (single operation)	°C	+55	+55
		ATA heating+ATW heating *5	°C	45 to 55	45 to 55
	Cooling		°C	-	-
Nominal return water temperature range	Heating	°C	+10 to +54	+10 to +54	
	Cooling	°C	-	-	
Water flow rate range		L/min	17.9 to 35.8	17.9 to 35.8	17.9 to 35.8

*1 32A, when indoor unit and outdoor unit are powered separately.

*2 In case of outdoor unit is set higher than indoor unit.

*3 In case of outdoor unit is set lower than indoor unit. (30 meters or less if PKFY-P*VBM, PFFY-P*VKM, PFFY-P*VL* type of indoor units are included.)

*4 10 to 52°C D.B.: When connecting PKFY-P15/20/25VBM, PFFY-P20/25/32VKM, PFFY-P20/25/32VLE(R)M, PEFY-P-VMA3 and M series, S series, and P series type indoor unit.

*5 In the case of ambient temperature is below 7°C, the flow temperature is decreased.

Model Name			PUMY-P112YKM4(-BS)	PUMY-P125YKM4(-BS)	PUMY-P140YKM4(-BS)
Power supply (phase, cycle, voltage)			3-phase 380-400-415 V, 50 Hz; 3-phase 380 V, 60 Hz		
	Max. current	A	12.0	12.0	12.0
Breaker size			20 ^{*1}	20 ^{*1}	20 ^{*1}
Outer casing			Galvanized plate	Galvanized plate	Galvanized plate
External finish			Munsell No. 3Y 7.8/1.1	Munsell No. 3Y 7.8/1.1	Munsell No. 3Y 7.8/1.1
Refrigerant control			Linear expansion valve	Linear expansion valve	Linear expansion valve
Compressor			Hermetic scroll	Hermetic scroll	Hermetic scroll
	Model		ANB33FNGMT	ANB33FNGMT	ANB33FNGMT
	Motor output	kW	2.9	3.5	3.9
	Start type		Inverter	Inverter	Inverter
	Protection devices		HP switch LP switch Comp. Surface thermo Over Current detection	HP switch LP switch Comp. Surface thermo Over Current detection	HP switch LP switch Comp. Surface thermo Over Current detection
	Oil (Model)	L	2.30 (FV50S)	2.30 (FV50S)	2.30 (FV50S)
Crankcase heater			W	-	-
Heat exchanger		Air	Plate fin coil	Plate fin coil	Plate fin coil
		Water	-	-	-
Fan	Fan(drive) x No.		Propeller fan x 2	Propeller fan x 2	Propeller fan x 2
	Fan motor output		kW	0.074 x 2	0.074 x 2
	Air flow		m ³ /min (CFM)	110 (3,884)	110 (3,884)
Defrost method			Reverse cycle	Reverse cycle	Reverse cycle
Noise level (SPL)	Heating	dB(A)	51	52	53
	Cooling	dB(A)	49	50	51
Noise level (PWL)	Heating	dB(A)	71	72	73
Dimensions	Width	mm(in)	1050 (41-11/32)	1050 (41-11/32)	1050 (41-11/32)
	Depth	mm(in)	330+40(13+1-9/16)	330+40(13+1-9/16)	330+40(13+1-9/16)
	Height	mm(in)	1338 (52-11/16)	1338 (52-11/16)	1338 (52-11/16)
Weight			kg(lbs)	125 (276)	125 (276)
Refrigerant (GWP)			R410A (1975)	R410A (1975)	R410A (1975)
	Quantity	kg(lbs)	4.8 (10.6)	4.8 (10.6)	4.8 (10.6)
Pipe size O.D.	Liquid	mm(in)	9.52 (3/8)	9.52 (3/8)	9.52 (3/8)
	Gas	mm(in)	15.88 (5/8)	15.88 (5/8)	15.88 (5/8)
Connection method			Flared	Flared	Flared
Between the indoor & outdoor unit	Height difference	m	Max. 50 ^{*2} Max. 40 ^{*3}	Max. 50 ^{*2} Max. 40 ^{*3}	Max. 50 ^{*2} Max. 40 ^{*3}
	Piping length	m	Max. 150m total Max. 80m for each	Max. 150m total Max. 80m for each	Max. 150m total Max. 80m for each
Guaranteed operating range (Outdoor)	ATW	Heating	°C (D.B.)	-20 to +21	-20 to +21
		DHW	°C (D.B.)	-20 to +35	-20 to +35
		Cooling	°C (D.B.)	-	-
	ATA	Heating	°C (D.B.)	-20 to +21	-20 to +21
		Cooling ^{*4}	°C (D.B.)	-5 to +52	-5 to +52
	ATW+ATA (simultaneous operation)	ATA heating+DHW	°C (D.B.)	7 to +21	7 to +21
ATA heating+ATW heating		°C (D.B.)	-10 to +21	-10 to +21	
Outlet water temp. (Max in heating, Min in cooling)	Heating	ATW (single operation)	°C	+55	+55
		ATA heating+ATW heating ^{*5}	°C	45 to 55	45 to 55
	Cooling		°C	-	-
Nominal return water temperature range	Heating	°C	+10 to +54	+10 to +54	+10 to +54
	Cooling	°C	-	-	-
Water flow rate range			L/min	17.9 to 35.8	17.9 to 35.8

*1 16A, when indoor unit and outdoor unit are powered separately.

*2 In case of outdoor unit is set higher than indoor unit.

*3 In case of outdoor unit is set lower than indoor unit. (30 meters or less if PKFY-P*VBM, PFFY-P*VKM, PFFY-P*VL* type of indoor units are included.)

*4 10 to 52°C D.B.: When connecting PKFY-P15/20/25VBM, PFFY-P20/25/32VKM, PFFY-P20/25/32VLE(R)M, PEFY-P·VMA3 and M series, S series, and P series type indoor unit.

*5 In the case of ambient temperature is below 7°C, the flow temperature is decreased.

1 Specifications

Outdoor unit

Outdoor unit

Model Name			PUMY-P112YKME4(-BS)	PUMY-P125YKME4(-BS)	PUMY-P140YKME4(-BS)
Power supply (phase, cycle, voltage)			3-phase 380-400-415 V, 50 Hz		
	Max. current	A	12.0	12.0	12.0
Breaker size			20 ^{*1}	20 ^{*1}	20 ^{*1}
Outer casing			Galvanized plate	Galvanized plate	Galvanized plate
External finish			Munsell No. 3Y 7.8/1.1	Munsell No. 3Y 7.8/1.1	Munsell No. 3Y 7.8/1.1
Refrigerant control			Linear expansion valve	Linear expansion valve	Linear expansion valve
Compressor			Hermetic scroll	Hermetic scroll	Hermetic scroll
	Model		ANB33FNGMT	ANB33FNGMT	ANB33FNGMT
	Motor output	kW	2.9	3.5	3.9
	Start type		Inverter	Inverter	Inverter
	Protection devices		HP switch LP switch Comp. Surface thermo Over Current detection	HP switch LP switch Comp. Surface thermo Over Current detection	HP switch LP switch Comp. Surface thermo Over Current detection
	Oil (Model)	L	2.30 (FV50S)	2.30 (FV50S)	2.30 (FV50S)
Crankcase heater			W	-	-
Heat exchanger	Air		Plate fin coil	Plate fin coil	Plate fin coil
	Water		-	-	-
Fan	Fan(drive) x No.		Propeller fan x 2	Propeller fan x 2	Propeller fan x 2
	Fan motor output	kW	0.074 x 2	0.074 x 2	0.074 x 2
	Air flow	m ³ /min (CFM)	110 (3,884)	110 (3,884)	110 (3,884)
Defrost method			Reverse cycle	Reverse cycle	Reverse cycle
Noise level (SPL)	Heating	dB(A)	51	52	53
	Cooling	dB(A)	49	50	51
Noise level (PWL)	Heating	dB(A)	71	72	73
Dimensions	Width	mm(in)	1050 (41-11/32)	1050 (41-11/32)	1050 (41-11/32)
	Depth	mm(in)	330+40(13+1-9/16)	330+40(13+1-9/16)	330+40(13+1-9/16)
	Height	mm(in)	1338 (52-11/16)	1338 (52-11/16)	1338 (52-11/16)
Weight			kg(lbs)	136 (300)	136 (300)
Refrigerant (GWP)			R410A (1975)	R410A (1975)	R410A (1975)
Pipe size O.D.	Quantity	kg(lbs)	4.8 (10.6)	4.8 (10.6)	4.8 (10.6)
	Liquid	mm(in)	9.52 (3/8)	9.52 (3/8)	9.52 (3/8)
	Gas	mm(in)	15.88 (5/8)	15.88 (5/8)	15.88 (5/8)
Connection method			Flared	Flared	Flared
Between the indoor & outdoor unit	Height difference	m	Max. 50 ^{*2} Max. 40 ^{*3}	Max. 50 ^{*2} Max. 40 ^{*3}	Max. 50 ^{*2} Max. 40 ^{*3}
	Piping length	m	Max. 150m total Max. 80m for each	Max. 150m total Max. 80m for each	Max. 150m total Max. 80m for each
Guaranteed operating range (Outdoor)	ATW	Heating	°C (D.B.)	-20 to +21	-20 to +21
		DHW	°C (D.B.)	-20 to +35	-20 to +35
		Cooling	°C (D.B.)	-	-
	ATA	Heating	°C (D.B.)	-20 to +21	-20 to +21
		Cooling ^{*4}	°C (D.B.)	-5 to +52	-5 to +52
	ATW+ATA (simultaneous operation)	ATA heating+DHW	°C (D.B.)	7 to +21	7 to +21
ATA heating+ATW heating		°C (D.B.)	-10 to +21	-10 to +21	
Outlet water temp. (Max in heating, Min in cooling)	Heating	ATW (single operation)	°C	+55	+55
		ATA heating+ATW heating ^{*5}	°C	45 to 55	45 to 55
	Cooling		°C	-	-
Nominal return water temperature range	Heating	°C	+10 to +54	+10 to +54	
	Cooling	°C	-	-	
Water flow rate range			L/min	17.9 to 35.8	17.9 to 35.8

*1 16A, when indoor unit and outdoor unit are powered separately.

*2 In case of outdoor unit is set higher than indoor unit.

*3 In case of outdoor unit is set lower than indoor unit. (30 meters or less if PKFY-P*VBM, PFFY-P*VKM, PFFY-P*VL* type of indoor units are included.)

*4 10 to 52°C D.B.: When connecting PKFY-P15/20/25VBM, PFFY-P20/25/32VKM, PFFY-P20/25/32VLE(R)M, PEFY-P·VMA3 and M series, S series, and P series type indoor unit.

*5 In the case of ambient temperature is below 7°C, the flow temperature is decreased.

1.2 Capacity

(1) Packaged-type units

■ Power inverter

Model name		PUHZ-W50VHA2(-BS)	PUHZ-W85VHA2(-BS)	PUHZ-W112VHA(-BS)	
Nominal water flow rate (Heating mode)		L/min	14.3	25.8	32.1
Heating (A7/W35)	Capacity	kW	5.00	9.00	11.20
	COP		4.50	4.18	4.47
	Power input	kW	1.11	2.15	2.51
Heating (A2/W35)	Capacity	kW	5.00	8.50	11.20
	COP		3.50	3.17	3.34
	Power input	kW	1.43	2.68	3.35
Pressure difference (water circuit)		kPa	12	13.5	6.3
Heating pump input (based on EN14511)		kW	0.01	0.046	0.01
Nominal water flow rate (Cooling mode)		L/min	12.9	21.5	28.7
Cooling (A35/W7)	Capacity	kW	4.50	7.50	10.00
	EER (COP)		2.94	2.47	2.80
	Power input	kW	1.53	3.04	3.57
Cooling (A35/W18)	Capacity	kW	4.50	7.50	10.00
	EER (COP)		4.44	3.93	4.50
	Power input	kW	1.01	1.91	2.22
Pressure difference (water circuit)		kPa	10	10	5
Cooling pump input (based on EN14511)		kW	0.01	0.033	0.01
Recommended plate heat exchanger			Built-in	Built-in	Built-in

Note: "COP" and "Power input" in the above table are values that contains the "pump input (based on EN 14511)".

Model name		PUHZ-W85V/YAA	PUHZ-W112V/YAA	
Nominal water flow rate (Heating mode)		L/min	25.8	32.1
Heating (A7/W35)	Capacity	kW	9.00	11.2
	COP		4.51	4.54
	Power input	kW	1.996	2.467
Heating (A2/W35)	Capacity	kW	8.50	11.2
	COP		3.36	3.34
	Power input	kW	2.530	3.353
Pressure difference (water circuit)		kPa	16	24
Heating pump input (based on EN14511)		kW	0.024	0.043
Nominal water flow rate (Cooling mode)		L/min	21.5	28.7
Cooling (A35/W7)	Capacity	kW	7.50	10.00
	EER (COP)		2.70	2.83
	Power input	kW	2.778	3.534
Cooling (A35/W18)	Capacity	kW	7.50	10.00
	EER (COP)		4.42	4.74
	Power input	kW	1.697	2.110
Pressure difference (water circuit)		kPa	11	20
Heating pump input (based on EN14511)		kW	0.014	0.032
Recommended plate heat exchanger			Built-in	Built-in

Note: "COP" and "Power input" in the above table are values that contains the "pump input (based on EN 14511)".

■ Zubadan

Model name		PUHZ-HW112YHA2(-BS)	PUHZ-HW140V/YHA2(-BS)	
Nominal water flow rate (Heating mode)		L/min	32.1	40.1
Heating (A7/W35)	Capacity	kW	11.20	14.00
	COP		4.43	4.26
	Power input	kW	2.53	3.29
Heating (A2/W35)	Capacity	kW	11.20	14.00
	COP		3.11	3.11
	Power input	kW	3.60	4.50
Pressure difference (water circuit)		kPa	6.3	9
Heating pump input (based on EN14511)		kW	0.01	0.02
Nominal water flow rate (Cooling mode)		L/min	28.7	35.8
Cooling (A35/W7)	Capacity	kW	10.00	12.50
	EER (COP)		2.78	2.50
	Power input	kW	3.60	5.00
Cooling (A35/W18)	Capacity	kW	10.00	12.50
	EER (COP)		4.10	3.60
	Power input	kW	2.44	3.47
Pressure difference (water circuit)		kPa	5	7
Cooling pump input (based on EN14511)		kW	0.01	0.02
Recommended plate heat exchanger			Built-in	Built-in

Note: "COP" and "Power input" in the above table are values that contains the "pump input (based on EN 14511)".

(2) Split-type units

■ Power inverter

Model name		SUHZ-SW45VA/VAH	
Nominal water flow rate (Heating mode)		L/min	12.9
Heating (A7/W35)	Capacity	kW	4.50
	COP		5.06
	Power input	kW	0.89
Heating (A2/W35)	Capacity	kW	3.50
	COP		3.40/3.04
	Power input	kW	1.03/1.15
Base heater input (only H model)		kW	0.12
Pressure difference (water circuit)		kPa	-
Heating pump input (based on EN14511)		kW	-
Nominal water flow rate (Cooling mode)		L/min	11.5
Cooling (A35/W7)	Capacity	kW	4.00
	EER (COP)		2.73
	Power input	kW	1.47
Cooling (A35/W18)	Capacity	kW	3.80
	EER (COP)		4.28
	Power input	kW	0.89
Pressure difference (water circuit)		kPa	-
Cooling pump input (based on EN14511)		kW	-
Recommended plate heat exchanger		MWA1-44DM	

The table shows performance data obtained when a plate heat exchanger is connected.

Model name		PUHZ-SW50VKA(-BS)		PUHZ-SW75VHA(-BS)	
Nominal water flow rate (Heating mode)		L/min	15.8	22.9	
Heating (A7/W35)	Capacity	kW	5.50	8.00	
	COP		4.42	4.40	
	Power input	kW	1.24	1.82	
Heating (A2/W35)	Capacity	kW	5.00	7.50	
	COP		2.97	3.40	
	Power input	kW	1.68	2.21	
Pressure difference (water circuit)		kPa	-	-	
Heating pump input (based on EN14511)		kW	-	-	
Nominal water flow rate (Cooling mode)		L/min	12.9	18.9	
Cooling (A35/W7)	Capacity	kW	4.50	6.60	
	EER (COP)		2.76	2.82	
	Power input	kW	1.63	2.34	
Cooling (A35/W18)	Capacity	kW	5.00	7.10	
	EER (COP)		4.60	4.43	
	Power input	kW	1.09	1.60	
Pressure difference (water circuit)		kPa	-	-	
Cooling pump input (based on EN14511)		kW	-	-	
Recommended plate heat exchanger		MWA1-44DM		MWA1-44DM	

The table shows performance data obtained when a plate heat exchanger is connected.

Model name		PUHZ-SW100VHA(-BS)	PUHZ-SW100YHA(-BS)
Nominal water flow rate (Heating mode)		L/min	32.1
Heating (A7/W35)	Capacity	kW	11.20
	COP		4.45
	Power input	kW	2.51
Heating (A2/W35)	Capacity	kW	10.00
	COP		3.32
	Power input	kW	3.01
Pressure difference (water circuit)		kPa	-
Heating pump input (based on EN14511)		kW	-
Nominal water flow rate (Cooling mode)		L/min	26.1
Cooling (A35/W7)	Capacity	kW	9.10
	EER (COP)		2.75
	Power input	kW	3.31
Cooling (A35/W18)	Capacity	kW	10.00
	EER (COP)		4.35
	Power input	kW	2.30
Pressure difference (water circuit)		kPa	-
Cooling pump input (based on EN14511)		kW	-
Recommended plate heat exchanger		ACH70-40	ACH70-40

The table shows performance data obtained when a plate heat exchanger is connected.

Model name		PUHZ-SW120VHA(-BS)	PUHZ-SW120YHA(-BS)
Nominal water flow rate (Heating mode)		L/min	45.9
Heating (A7/W35)	Capacity	kW	16.00
	COP		4.10
	Power input	kW	3.90
Heating (A2/W35)	Capacity	kW	12.00
	COP		3.24
	Power input	kW	3.70
Pressure difference (water circuit)		kPa	-
Heating pump input (based on EN14511)		kW	-
Nominal water flow rate (Cooling mode)		L/min	35.8
Cooling (A35/W7)	Capacity	kW	12.50
	EER (COP)		2.32
	Power input	kW	5.39
Cooling (A35/W18)	Capacity	kW	14.00
	EER (COP)		4.08
	Power input	kW	3.43
Pressure difference (water circuit)		kPa	-
Cooling pump input (based on EN14511)		kW	-
Recommended plate heat exchanger		ACH70-40	ACH70-40

The table shows performance data obtained when a plate heat exchanger is connected.

1 Specifications

Outdoor unit

Model name			PUHZ-SW160YKA(-BS)	PUHZ-SW200YKA(-BS)
Nominal water flow rate (Heating mode)		L/min	63.1	71.7
Heating (A7/W35)	Capacity	kW	22.00	25.00
	COP		4.20	4.00
	Power input	kW	5.24	6.25
Heating (A2/W35)	Capacity	kW	16.00	20.00
	COP		3.11	2.80
	Power input	kW	5.14	7.14
Pressure difference (water circuit)		kPa	-	-
Heating pump input (based on EN14511)		kW	-	-
Nominal water flow rate (Cooling mode)		L/min	45.9	57.3
Cooling (A35/W7)	Capacity	kW	16.00	20.00
	EER (COP)		2.76	2.25
	Power input	kW	5.80	8.89
Cooling (A35/W18)	Capacity	kW	18.00	22.00
	EER (COP)		4.56	4.10
	Power input	kW	3.95	5.37
Pressure difference (water circuit)		kPa	-	-
Cooling pump input (based on EN14511)		kW	-	-
Recommended plate heat exchanger			ACH70-40 ×2 Parallel connection	ACH70-40 ×2 Parallel connection

The table shows performance data obtained when a plate heat exchanger is connected.

Model name			PUHZ-SW75VAA(-BS)	PUHZ-SW75YAA(-BS)
Nominal water flow rate (Heating mode)		L/min	22.9	22.9
Heating (A7/W35)	Capacity	kW	8.0	8.0
	COP		4.40	4.40
	Power input	kW	1.82	1.82
Heating (A2/W35)	Capacity	kW	7.5	7.5
	COP		3.4	3.4
	Power input	kW	2.21	2.21
Pressure difference (water circuit)		kPa	-	-
Heating pump input (based on EN14511)		kW	-	-
Nominal water flow rate (Cooling mode)		L/min	20.4	20.4
Cooling (A35/W7)	Capacity	kW	7.1	7.1
	EER (COP)		2.7	2.7
	Power input	kW	2.63	2.63
Cooling (A35/W18)	Capacity	kW	7.1	7.1
	EER (COP)		4.43	4.43
	Power input	kW	1.60	1.60
Pressure difference (water circuit)		kPa	-	-
Cooling pump input (based on EN14511)		kW	-	-
Recommended plate heat exchanger			MWA1-44DM	MWA1-44DM

The table shows performance data obtained when a plate heat exchanger is connected.

Model name		PUHZ-SW100VAA(-BS)	PUHZ-SW100YAA(-BS)
Nominal water flow rate (Heating mode)		L/min	32.1
Heating (A7/W35)	Capacity	kW	11.2
	COP		4.46
	Power input	kW	2.51
Heating (A2/W35)	Capacity	kW	10.0
	COP		3.32
	Power input	kW	3.01
Pressure difference (water circuit)		kPa	-
Heating pump input (based on EN14511)		kW	-
Nominal water flow rate (Cooling mode)		L/min	28.7
Cooling (A35/W7)	Capacity	kW	10.0
	EER (COP)		2.83
	Power input	kW	3.53
Cooling (A35/W18)	Capacity	kW	10.0
	EER (COP)		4.47
	Power input	kW	2.24
Pressure difference (water circuit)		kPa	-
Cooling pump input (based on EN14511)		kW	-
Recommended plate heat exchanger		MWA2-38PA	MWA2-38PA

The table shows performance data obtained when a plate heat exchanger is connected.

■ Mr.SLIM+

Model name		PUHZ-FRP71VHA2	
Nominal water flow rate (Heating mode)		L/min	
		22.9	
Heating (A7/W35)	Capacity	kW	
			8.00
	COP		4.08
Heating (A2/W35)	Power input	kW	
			1.96
	COP		2.83
Heating (A2/W35)	Capacity	kW	
			7.50
	COP		2.83
Heating (A2/W35)	Power input	kW	
			2.65
	Pressure difference (water circuit)		kPa
		-	
Heating pump input (based on EN14511)		kW	
		-	
Recommended plate heat exchanger		ACH70-40	

The table shows performance data obtained when a plate heat exchanger is connected.

■ Zubadan

Model name		PUHZ-SHW80VHA(-BS)	PUHZ-SHW112VHA(-BS)	
Nominal water flow rate (Heating mode)		L/min	22.9	32.1
Heating (A7/W35)	Capacity	kW	8.00	11.20
	COP		4.65	4.46
	Power input	kW	1.72	2.51
Heating (A2/W35)	Capacity	kW	8.00	11.20
	COP		3.55	3.34
	Power input	kW	2.25	3.35
Pressure difference (water circuit)		kPa	-	-
Heating pump input (based on EN14511)		kW	-	-
Nominal water flow rate (Cooling mode)		L/min	20.4	28.7
Cooling (A35/W7)	Capacity	kW	7.10	10.00
	EER (COP)		3.31	2.83
	Power input	kW	2.15	3.53
Cooling (A35/W18)	Capacity	kW	7.10	10.00
	EER (COP)		4.52	4.74
	Power input	kW	1.57	2.11
Pressure difference (water circuit)		kPa	-	-
Cooling pump input (based on EN14511)		kW	-	-
Recommended plate heat exchanger			ACH70-40	ACH70-40

The table shows performance data obtained when a plate heat exchanger is connected.

Model name		PUHZ-SHW112YHA(-BS)	PUHZ-SHW140YHA(-BS)	
Nominal water flow rate (Heating mode)		L/min	32.1	40.1
Heating (A7/W35)	Capacity	kW	11.20	14.00
	COP		4.46	4.22
	Power input	kW	2.51	3.32
Heating (A2/W35)	Capacity	kW	11.20	14.00
	COP		3.34	2.96
	Power input	kW	3.35	4.73
Pressure difference (water circuit)		kPa	-	-
Heating pump input (based on EN14511)		kW	-	-
Nominal water flow rate (Cooling mode)		L/min	28.7	35.8
Cooling (A35/W7)	Capacity	kW	10.00	12.50
	EER (COP)		2.83	2.17
	Power input	kW	3.53	5.76
Cooling (A35/W18)	Capacity	kW	10.00	12.50
	EER (COP)		4.74	4.26
	Power input	kW	2.11	2.93
Pressure difference (water circuit)		kPa	-	-
Cooling pump input (based on EN14511)		kW	-	-
Recommended plate heat exchanger			ACH70-40	ACH70-40

The table shows performance data obtained when a plate heat exchanger is connected.

Model name		PUHZ-SHW230YKA2	
Nominal water flow rate (Heating mode)		L/min	65.9
Heating (A7/W35)	Capacity	kW	23.00
	COP		3.65
	Power input	kW	6.31
Heating (A2/W35)	Capacity	kW	23.00
	COP		2.37
	Power input	kW	9.71
Pressure difference (water circuit)		kPa	-
Heating pump input (based on EN14511)		kW	-
Nominal water flow rate (Cooling mode)		L/min	57.3
Cooling (A35/W7)	Capacity	kW	20.00
	EER (COP)		2.22
	Power input	kW	9.01
Cooling (A35/W18)	Capacity	kW	20.00
	EER (COP)		3.55
	Power input	kW	5.63
Pressure difference (water circuit)		kPa	-
Cooling pump input (based on EN14511)		kW	-
Recommended plate heat exchanger		ACH70-40 x 2 Parallel connection	

The table shows performance data obtained when a plate heat exchanger is connected.

Model name		PUHZ-SHW80VAA(-BS)		PUHZ-SHW80YAA(-BS)	
Nominal water flow rate (Heating mode)		L/min	22.9	22.9	
Heating (A7/W35)	Capacity	kW	8.0	8.0	
	COP		4.65	4.65	
	Power input	kW	1.72	1.72	
Heating (A2/W35)	Capacity	kW	8.0	8.0	
	COP		3.55	3.55	
	Power input	kW	2.25	2.25	
Pressure difference (water circuit)		kPa	-	-	
Heating pump input (based on EN14511)		kW	-	-	
Nominal water flow rate (Cooling mode)		L/min	20.4	20.4	
Cooling (A35/W7)	Capacity	kW	7.1	7.1	
	EER (COP)		3.31	3.31	
	Power input	kW	2.15	2.15	
Cooling (A35/W18)	Capacity	kW	7.1	7.1	
	EER (COP)		4.52	4.52	
	Power input	kW	1.57	1.57	
Pressure difference (water circuit)		kPa	-	-	
Cooling pump input (based on EN14511)		kW	-	-	
Recommended plate heat exchanger		MWA2-38PA		MWA2-38PA	

The table shows performance data obtained when a plate heat exchanger is connected.

Model name		PUHZ-SHW112VAA(-BS)	PUHZ-SHW112YAA(-BS)
Nominal water flow rate (Heating mode)		L/min	32.1
Heating (A7/W35)	Capacity	kW	11.2
	COP		4.46
	Power input	kW	2.51
Heating (A2/W35)	Capacity	kW	11.2
	COP		3.22
	Power input	kW	3.48
Pressure difference (water circuit)		kPa	-
Heating pump input (based on EN14511)		kW	-
Nominal water flow rate (Cooling mode)		L/min	28.7
Cooling (A35/W7)	Capacity	kW	10.0
	EER (COP)		2.83
	Power input	kW	3.53
Cooling (A35/W18)	Capacity	kW	10.0
	EER (COP)		4.74
	Power input	kW	2.11
Pressure difference (water circuit)		kPa	-
Cooling pump input (based on EN14511)		kW	-
Recommended plate heat exchanger		MWA2-38PA	MWA2-38PA

The table shows performance data obtained when a plate heat exchanger is connected.

■ Inverter multi

Model name		PUMY-P112V/YKM(E)4(-BS)	PUMY-P125V/YKM(E)4(-BS)	PUMY-P140V/YKM(E)4(-BS)
Nominal water flow rate (Heating mode)		L/min	35.8	35.8
Heating (A7/W35)	Capacity	kW	12.5	12.5
	COP*		4.08	4.08
	Power input	kW	3.06	3.06
Heating (A2/W35)	Capacity	kW	10.0	10.0
	COP*		2.86	2.86
	Power input	kW	3.50	3.50
Pressure difference (water circuit)		kPa	-	-
Heating pump input (based on EN14511)		kW	-	-
Recommended plate heat exchanger		MWA2-38-PA-4	MWA2-38-PA-4	MWA2-38-PA-4

The table shows performance data obtained when a plate heat exchanger is connected.

* In case of ATW unit single connection, the COP for ATW heating decreases depending on the number of connected ATA units (Refer to the figure below).

ATW COP reduction ratio by ATA indoor units

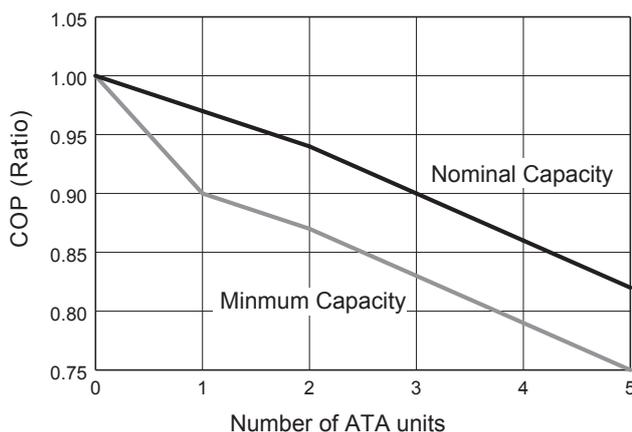

	0	1	2	3	4	5
Nominal Capacity	1.00	0.97	0.94	0.90	0.86	0.82
Minimum Capacity	1.00	0.90	0.87	0.83	0.79	0.75

1.3 Maximum outlet water temperature

(1) Packaged-type units

■ Power inverter

PUHZ-W50VHA2(-BS)

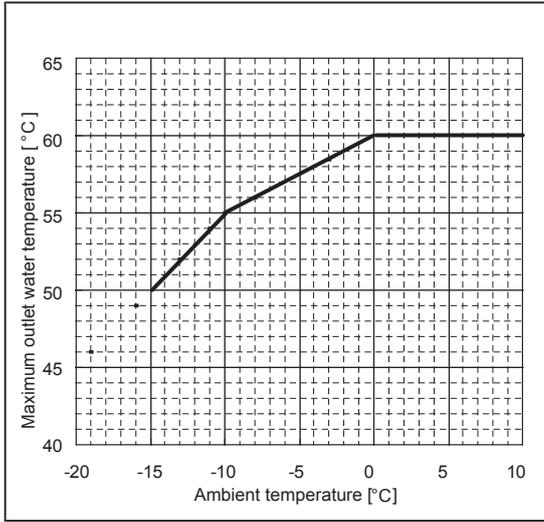

PUHZ-W85VHA2(-BS) PUHZ-W112VHA(-BS)

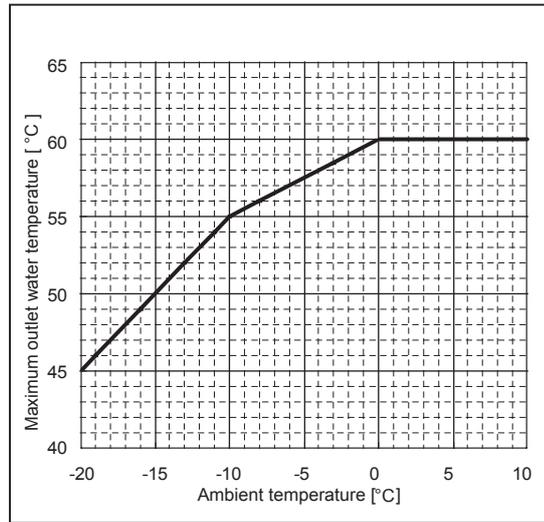

**PUHZ-W85VAA
PUHZ-W85YAA**

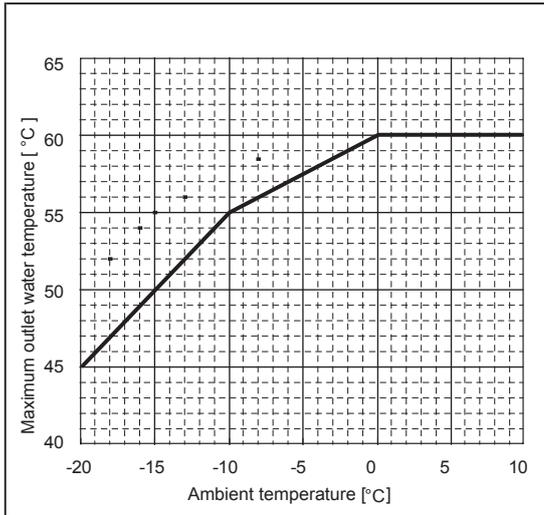

**PUHZ-W112VAA
PUHZ-W112YAA**

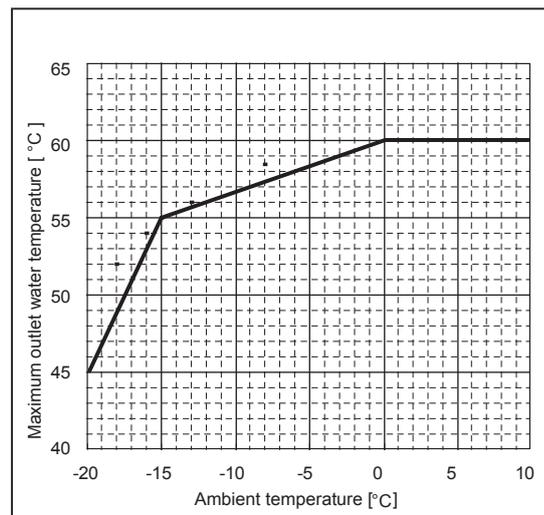

■ Zubadan

PUHZ-HW112/140YHA2(-BS) PUHZ-HW140VHA2(-BS)

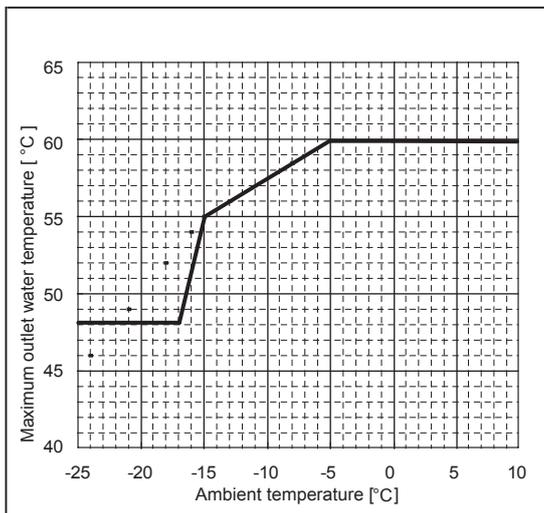

(2) Split-type units

■ Power inverter

SUHZ-SW45VA(H)

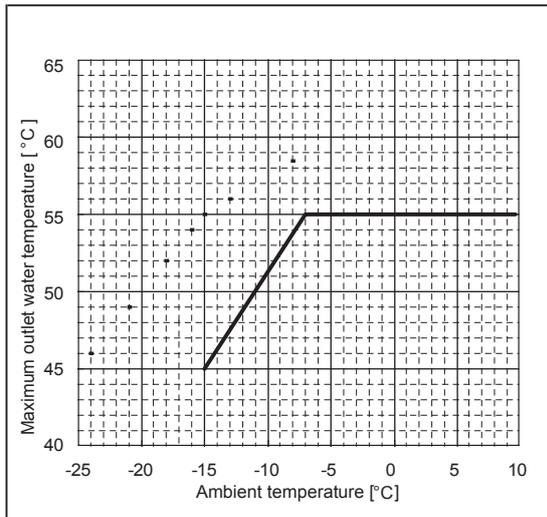

PUHZ-SW50VKA(-BS)

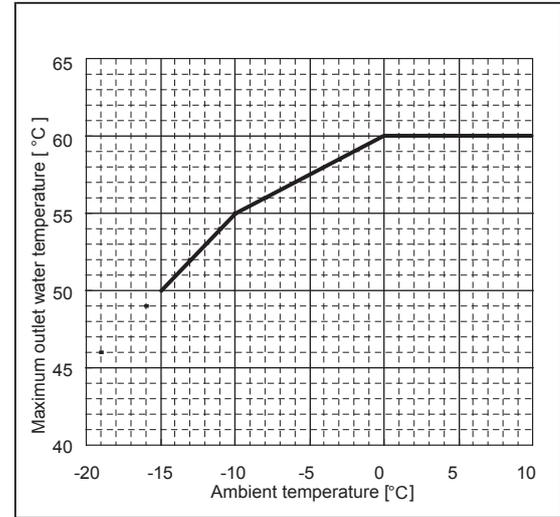

PUHZ-SW75VHA(-BS)

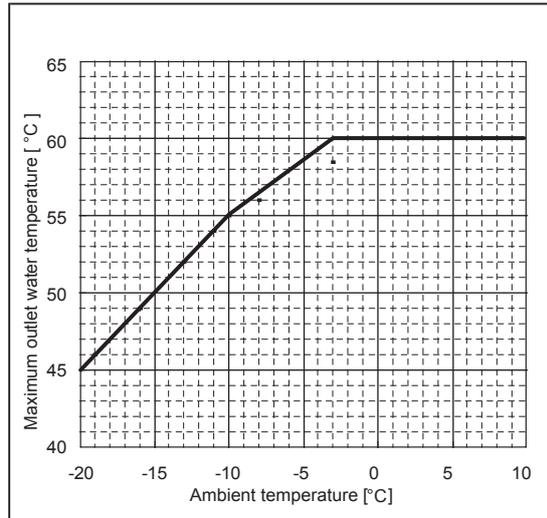

PUHZ-SW100/120VHA(-BS)

PUHZ-SW100/120YHA(-BS)

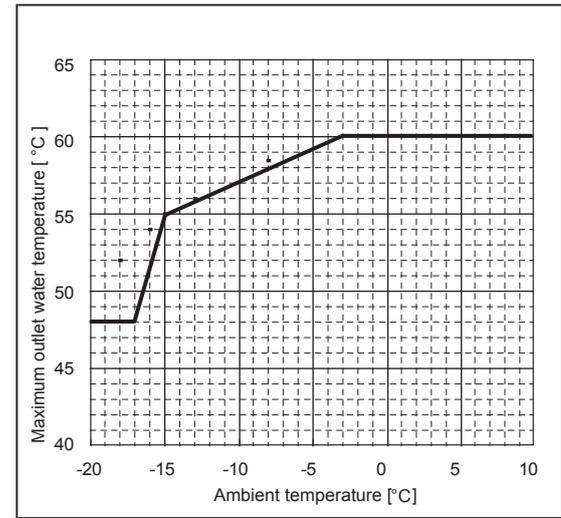

PUHZ-SW160/200YKA(-BS)

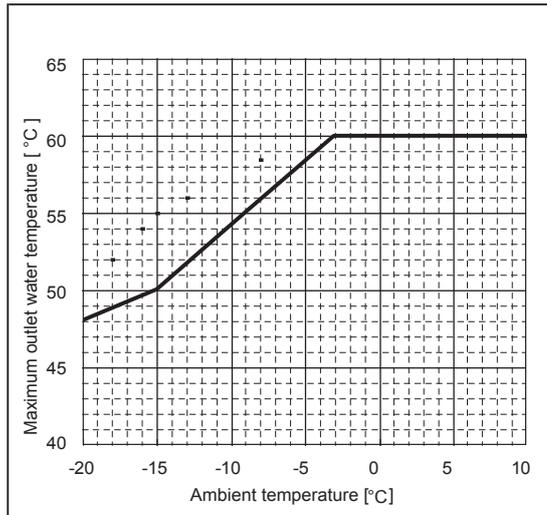

**PUHZ-SW75VAA(-BS)
PUHZ-SW75YAA(-BS)**

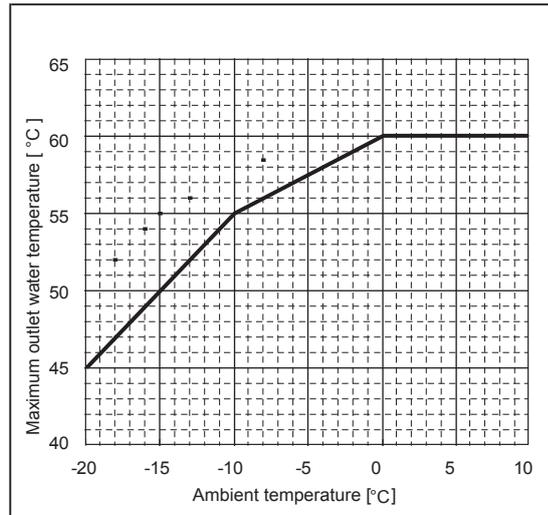

**PUHZ-SW100VAA(-BS)
PUHZ-SW100YAA(-BS)**

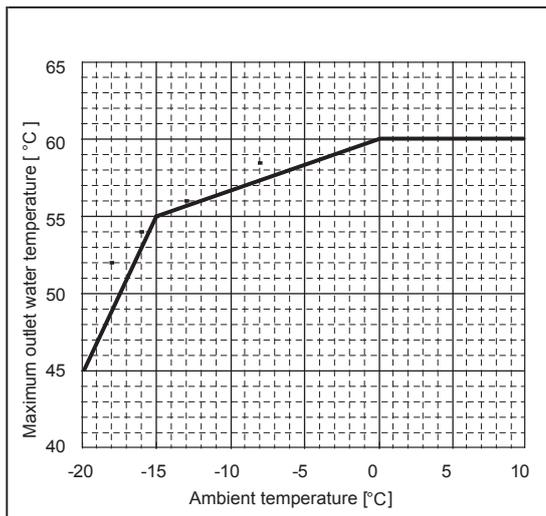

**■Mr.SLIM+
PUHZ-FRP71VHA2**

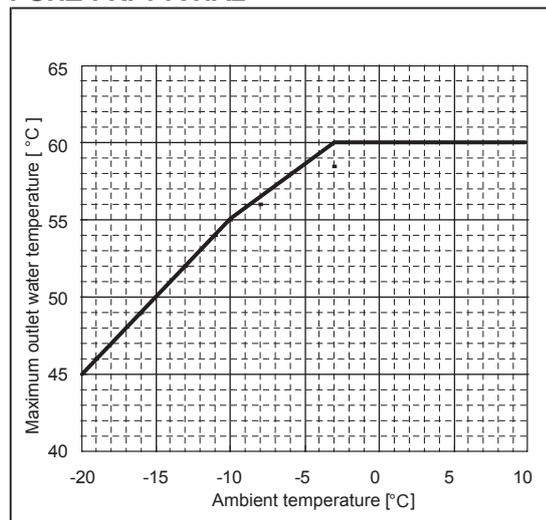

■Zubadan

PUHZ-SHW80/112VHA(-BS)
 PUHZ-SHW112/140YHA(-BS)
 PUHZ-SHW230YKA2

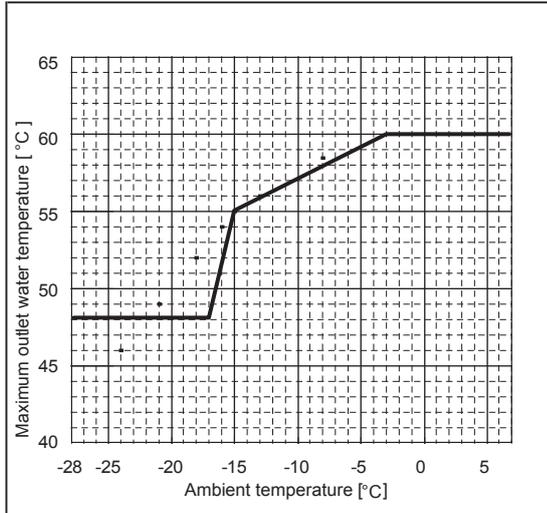

*PUHZ-SHW80/112/140 Service reference number from "R2": down to -28°C
 Before "R2" and PUHZ-SHW230 : down to -25°C

PUHZ-SHW80/112VAA(-BS)
 PUHZ-SHW80/112YAA(-BS)

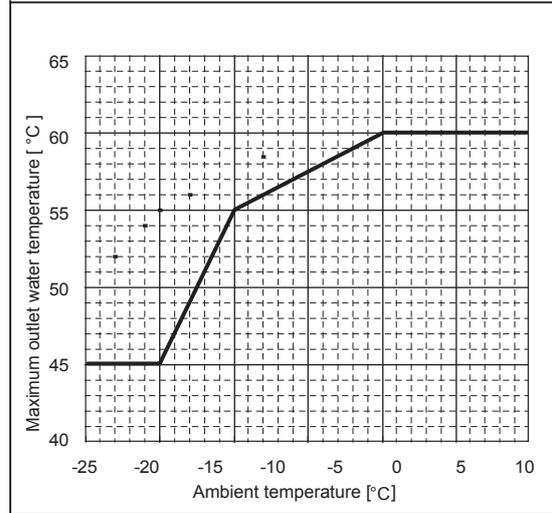

■Inverter multi

PUMY-P112/125/140VKM4(-BS)
 PUMY-P112/125/140YKM4(-BS)
 PUMY-P112/125/140YKME4(-BS)

Maximum outlet water temperature curve at single operation of ATW Heating

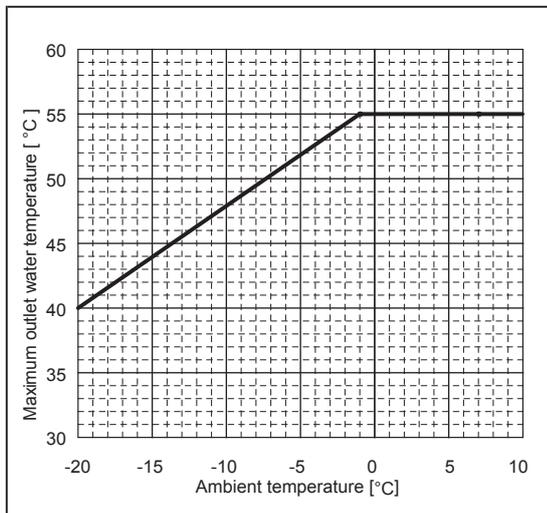

Maximum outlet water temperature curve at simultaneous operation of ATA Heating and ATW heating

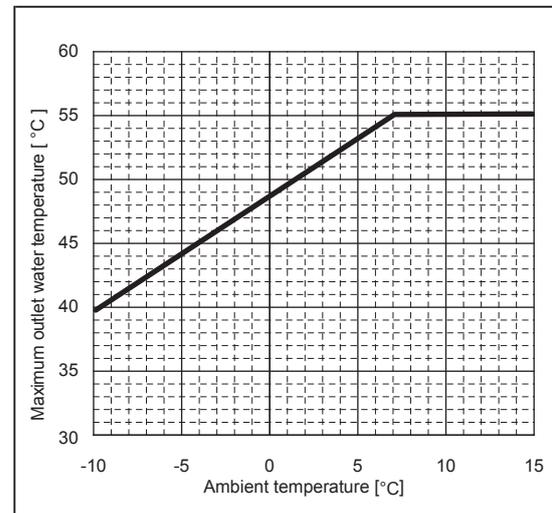

Notice for PUMY+ecodan (Cylinder unit, Hydrobox) system

Please note following notices about restrictions to use PUMY with ATA indoor unit and ATW indoor unit (ecodan Cylinder unit, Hydrobox).

1. Operating patterns

ATA: cooling & heating are possible, ATW (Cylinder unit or Hydrobox): DHW & Heating are possible.

ATW (Cylinder or Hydrobox) : cooling is NOT possible.

Priority: DHW > ATW Heating > ATA

Mode	ATA	ATW	
Cooling	Cooling	Cooling	Not available
	Cooling	Off	OK
	Off	Cooling	Not available
Heating	Heating	Space Heating	OK*
	Heating	DHW	OK*
	Heating	Off	OK
	Off	Space Heating	OK
	Off	DHW	OK
Cooling & Heating	Cooling	Space Heating	Not available
	Cooling	DHW	Not available
	Heating	Cooling	Not available

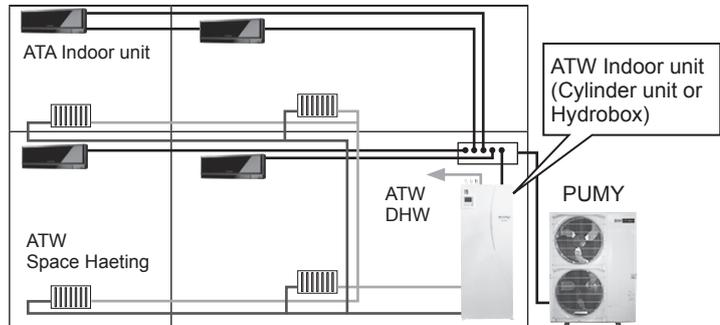

* The simultaneous operation of ATA and ATW (DHW or heating) is possible but with some restrictions on the total capacity of connected unit(s), ambient temperature, and outlet water temperature.

2. Main operating patterns for each season

<Summer>

DHW and ATA cooling are operated in different times.

Daytime: ATA Cooling, Nighttime: DHW

	1	6	12	18	24
ATA	Off		Cooling	Off	
ATW		DHW	Off		

In summer season, the DHW capability may be decreased; When the certain conditions have been satisfied, a heater will turn on.

If demands of DHW and ATA cooling come at the same time, the system operates in DHW mode and ATA cooling is standby.

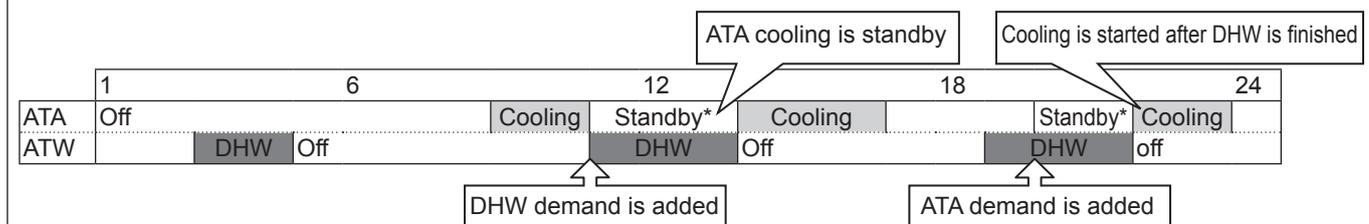

* Standby: Operation in standby mode is different by each model

Type	Indoor FAN	Indication
M series	Stopped	LED on indoor unit is blinking
City Multi series	Stopped	Remote controller display is blinking
P and S series	Fan mode	Remote controller display is blinking

FAN mode is NOT recommended during DHW operation in Summer season to avoid radiant heat.

<Spring, Autumn>

In these season, user can demand heating just in time using ATA system.

ATA heating and DHW are operated in different times.

Daytime: ATA Heating, Nighttime: DHW

	1	6	12	18	24
ATA	Off		Heating	Off	
ATW		DHW	Off		

<Winter>

ATW heating and DHW are operated in different times. (same as ecodan single operation)

	1	6	12	18	24
ATA					
ATW	SH	DHW	Space Heating		

3. Optional operation patterns

In the case of simultaneous operation, ensure that the total capacity of ATA and ATW indoor units is under 100% of the outdoor unit capacity. (Refer to Table 1 and Table 2 below.)

<Option 1>

Simultaneous operation: "ATW heating" and "ATA heating"

In the case of simultaneous operation of ATA heating and ATW heating, target flow temperature range restricted as 45-55°C. Do not use the simultaneous operation of ATW heating and ATA heating when the ambient temperature is below -10°C. In the case of ambient temperature is below 7°C, the flow temperature is decreased. (For the temperature curve at simultaneous operation, refer to DATA BOOK.)



ATA demand is added

- Total Capacity (ATA + ATW) \leq 100%
 - Outdoor temperature \geq -10°C
- Simultaneous operation can be produced.

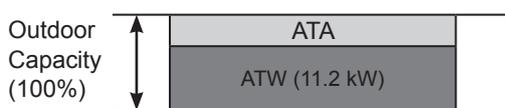

Connectable ATA units for simultaneous operation in cooling capacity Table 1

P112	Up to 1.3kW Exceptionally, one unit of MSZ-SF15VA or MSZ-AP15VF can be connected.
P125	Up to 2.8kW Exceptionally, two units of MSZ-SF15VA or MSZ-AP15VF can be connected.
P140	Up to 4.3kW Exceptionally, three units of MSZ-SF15VA or MSZ-AP15VF can be connected.

<Option 2>

Simultaneous operation: "DHW" and "ATA heating"

Note: At ambient temperature of below 7°C, the simultaneous operation of DHW and ATA heating cannot be used. ATA enters to standby(*) mode, and remote controller display blinks. Also, if the ambient temperature has decreased below 7°C during simultaneous operation, ATA will enter to standby mode.

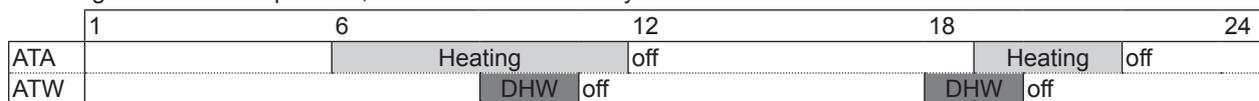

DHW demand is added

ATA demand is added

- Total Capacity (ATA + ATW) \leq 100%
 - Outdoor temperature \geq 7°C
- Simultaneous operation can be produced.

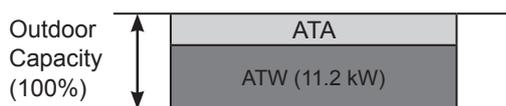

Connectable ATA units for simultaneous operation in cooling capacity Table 2

P112	Up to 1.3kW Exceptionally, one unit of MSZ-SF15VA or MSZ-AP15VF can be connected.
P125	Up to 2.8kW Exceptionally, two units of MSZ-SF15VA or MSZ-AP15VF can be connected.
P140	Up to 4.3kW Exceptionally, three units of MSZ-SF15VA or MSZ-AP15VF can be connected.

* Standby: Operation in standby mode is different by each model

Type	Indoor FAN	Indication
M series	Stopped	LED on indoor unit is blinking
City Multi series	Stopped	Remote controller display is blinking
P and S series	Fan mode	Remote controller display is blinking

To avoid any inconveniences, ATA and DHW should basically be operated separately, by each schedule settings.

4. Restrictions

- Only one ecodan unit (Cylinder unit or Hydro box) can be connected.
- When the simultaneous operation of ATA and ATW is not used, the total capacity of connected indoor units is the total ATA capacity of 130% plus one ATW (Cylinder or Hydro box).
- During DHW operation, eco mode cannot be used.
- The maximum outlet water temperature when operating PUMY + ecodan is 55°C. A heater will turn on when the set temperature is over 55°C.
- An energy monitor function cannot be used.
- The multiple unit control function of ATW (Cylinder unit or Hydro box) cannot be used.
- An M-net remote controller cannot be connected to ecodan unit.
- The boiler interlock function activates only by the judgment based on ambient temperature.
- Do not group ATW (Cylinder unit or Hydro box) and ATA unit.
- The COP for ATW heating decreases depending on the number of connected ATA units.
- Conduct test runs using indoor unit remote controllers. (Do not use test run switches on outdoor units.)
- When conducting a pump down operation, ensure that the ATA unit is in cooling operation. (Do not use the DipSW functions of outdoor unit)
- When an ATW (Cylinder unit or Hydro box) is connected, the auto change over function of ATA indoor unit cannot be used.

1.4 Available range (Water flow rate, return water temp.)

(1) Packaged-type units

■ Heating

PUHZ-W50VHA2(-BS)

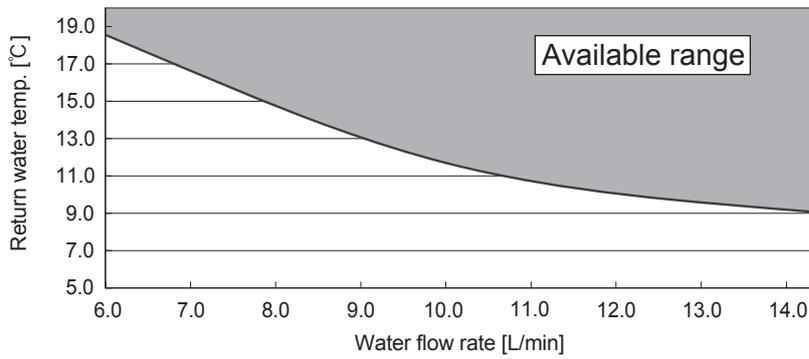

PUHZ-W85VHA2(-BS) PUHZ-W85VAA PUHZ-W85YAA

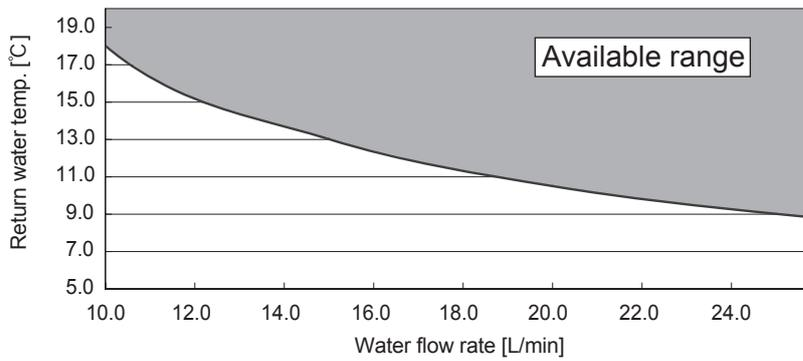

PUHZ-W112VHA(-BS) PUHZ-HW112/140YHA2(-BS) PUHZ-HW140VHA2(-BS)
PUHZ-W112VAA PUHZ-W112YAA

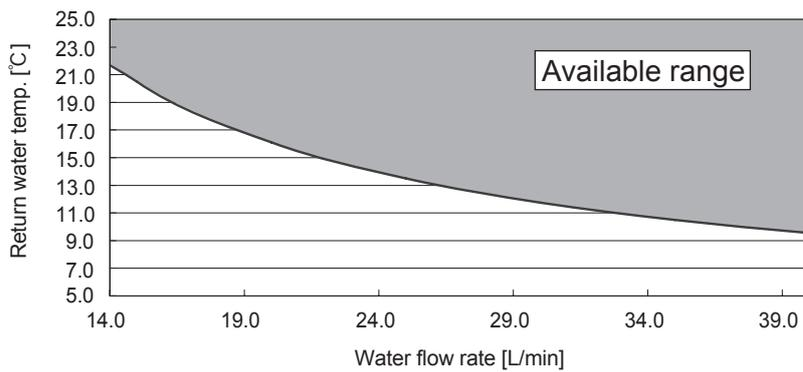

■ Cooling

PUHZ-W50VHA2(-BS)

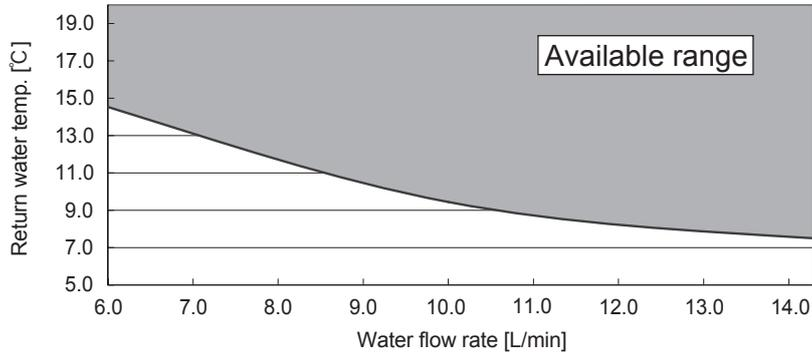

PUHZ-W85VHA2(-BS) PUHZ-W85VAA PUHZ-W85YAA

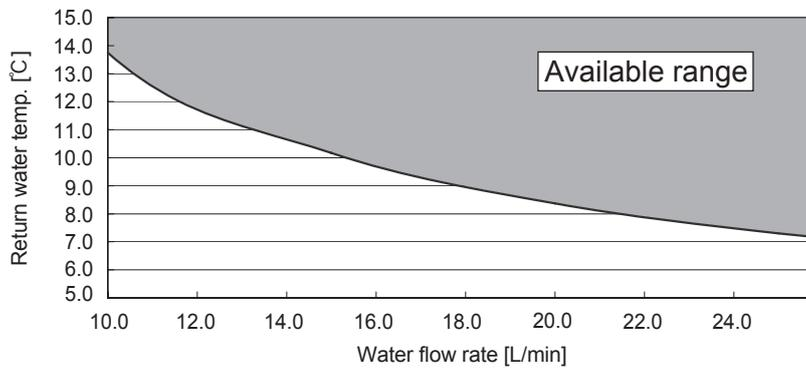

PUHZ-W112VHA(-BS) PUHZ-HW112/140YHA2(-BS) PUHZ-HW140VHA2(-BS) PUHZ-W112VAA PUHZ-W112YAA

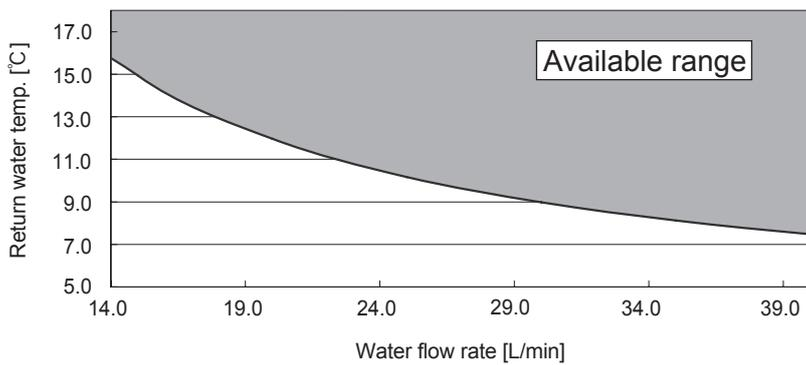

(2) Split-type units*

* When a recommended plate heat exchanger is installed.

■ Heating

SUHZ-SW45VA(H)
PUHZ-SW50VKA(-BS)

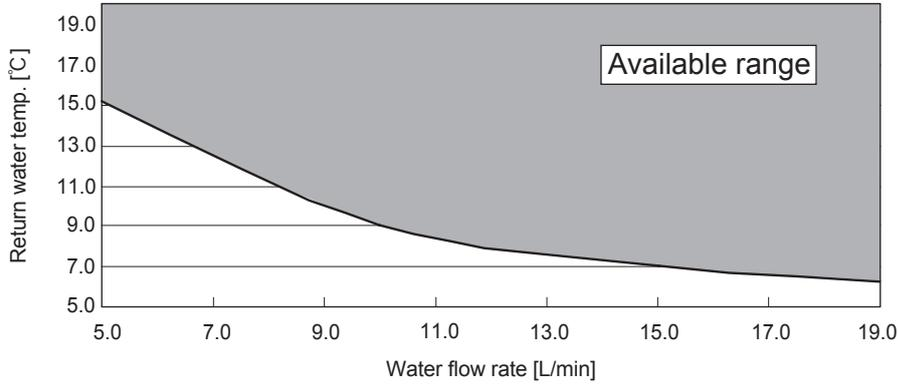

PUHZ-SW75VHA(-BS) **PUHZ-SW75VAA(-BS)**
PUHZ-SHW80VHA(-BS) **PUHZ-SW75YAA(-BS)**

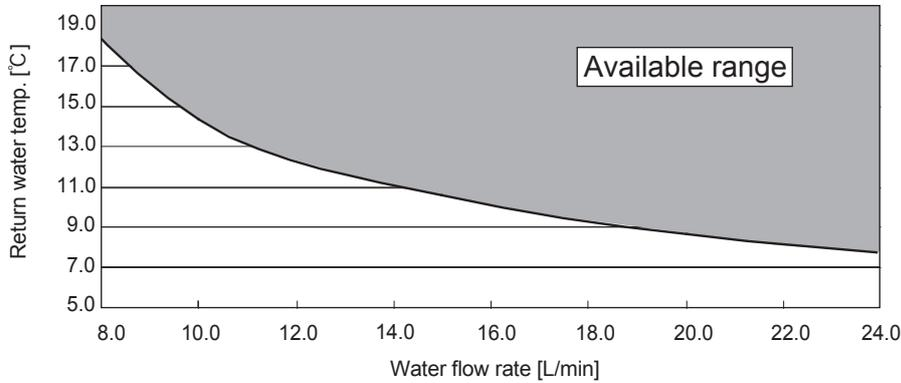

PUHZ-SW100/120VHA(-BS) **PUHZ-SHW112VHA(-BS)**
PUHZ-SW100/120YHA(-BS) **PUHZ-SHW112/140YHA(-BS)**
PUHZ-SW100VAA(-BS) **PUHZ-SHW80/112VAA(-BS)**
PUHZ-SW100YAA(-BS) **PUHZ-SHW80/112YAA(-BS)**

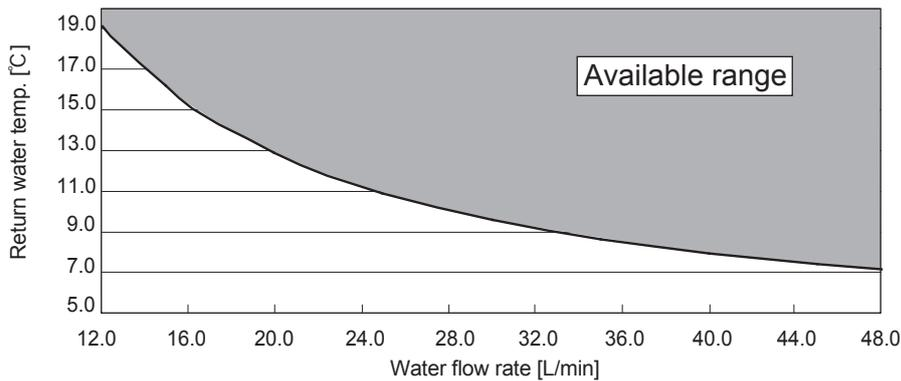

PUHZ-SW160YKA(-BS) **PUHZ-SW200YKA(-BS)**

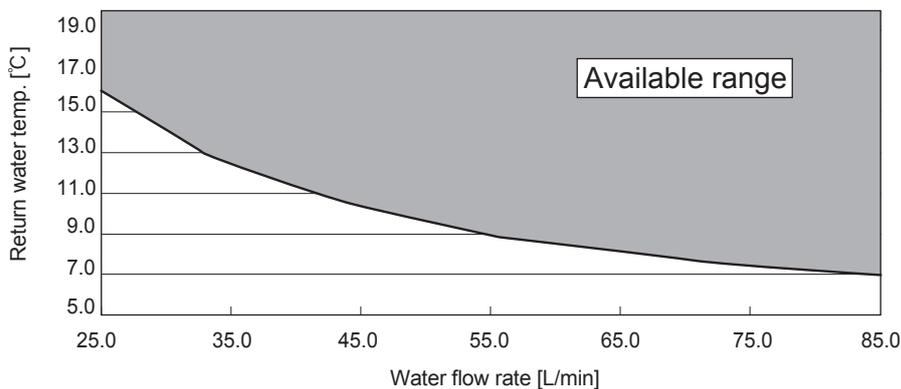

PUHZ-SHW230YKA2

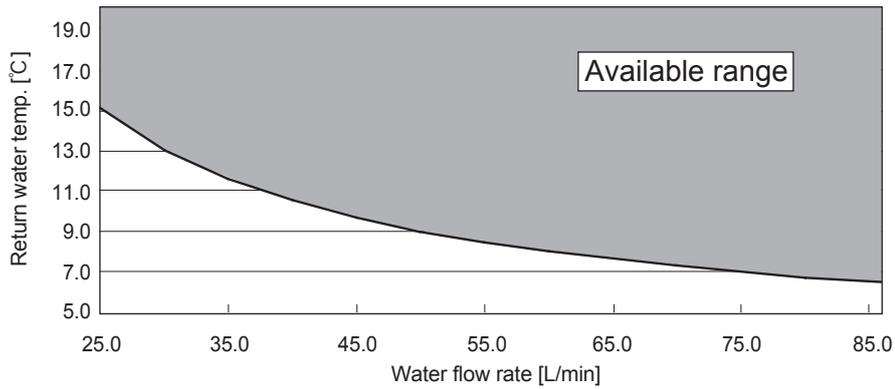

PUHZ-FRP71VHA2

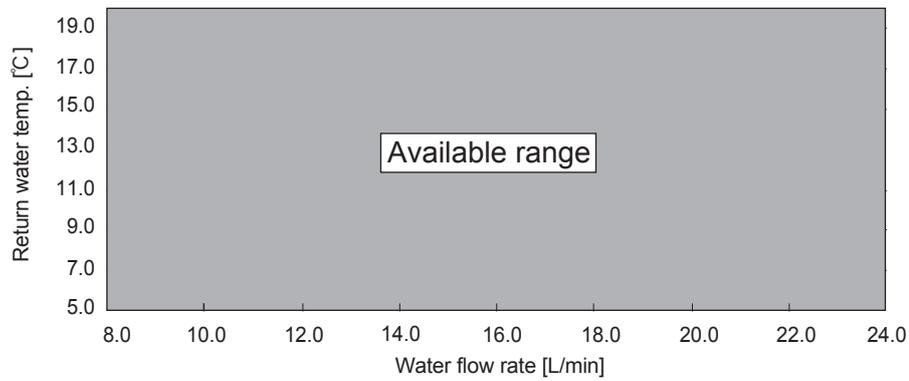

<Note>

Water circuit will not be used during defrost in FRP system.

PUMY-P112/125/140VKM4(-BS) PUMY-P112/125/140YKM4(-BS) PUMY-P112/125/140YKME4(-BS)

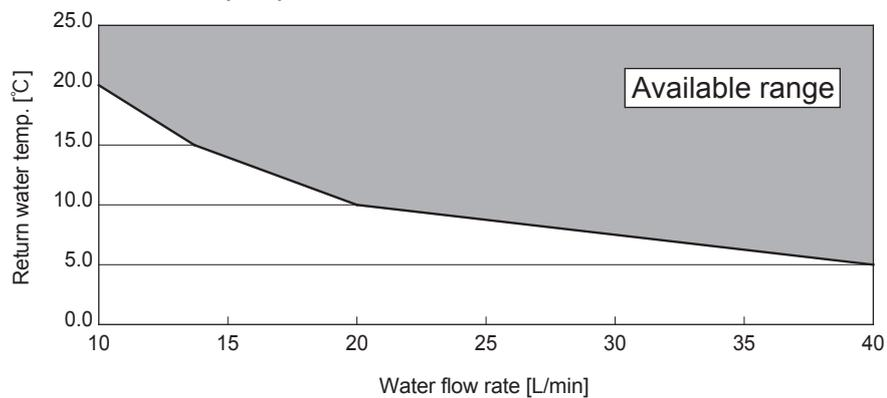

■ Cooling

**SUHZ-SW45VA(H)
PUHZ-SW50VKA(-BS)**

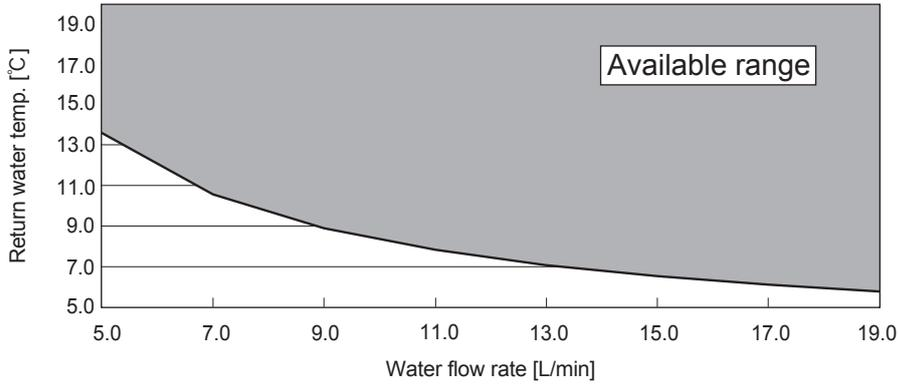

**PUHZ-SW75VHA(-BS) PUHZ-SW75VAA(-BS)
PUHZ-SW75YAA(-BS)**

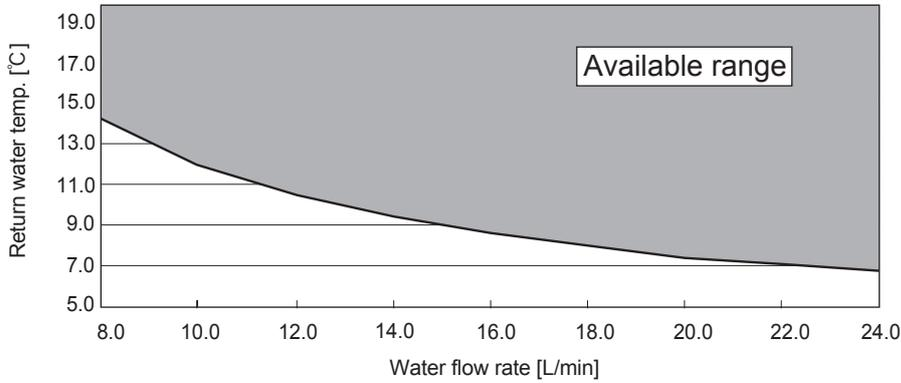

**PUHZ-SW100VHA(-BS) PUHZ-SHW80/112VHA(-BS)
PUHZ-SW100YHA(-BS) PUHZ-SHW112/140YHA(-BS)
PUHZ-SW100VAA(-BS) PUHZ-SHW80/112VAA(-BS)
PUHZ-SW100YAA(-BS) PUHZ-SHW80/112YAA(-BS)**

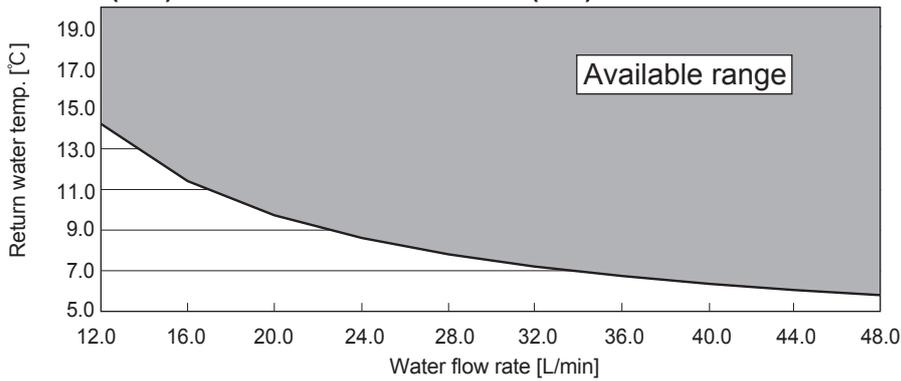

**PUHZ-SW120VHA(-BS)
PUHZ-SW120YHA(-BS)**

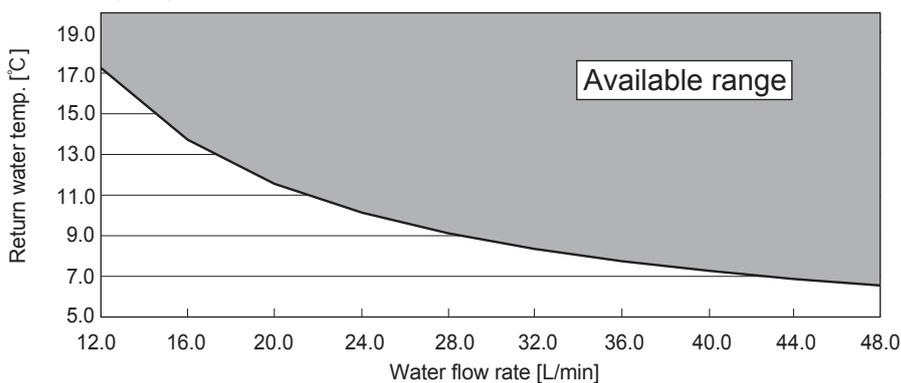

PUHZ-SW160YKA(-BS)
PUHZ-SW200YKA(-BS)

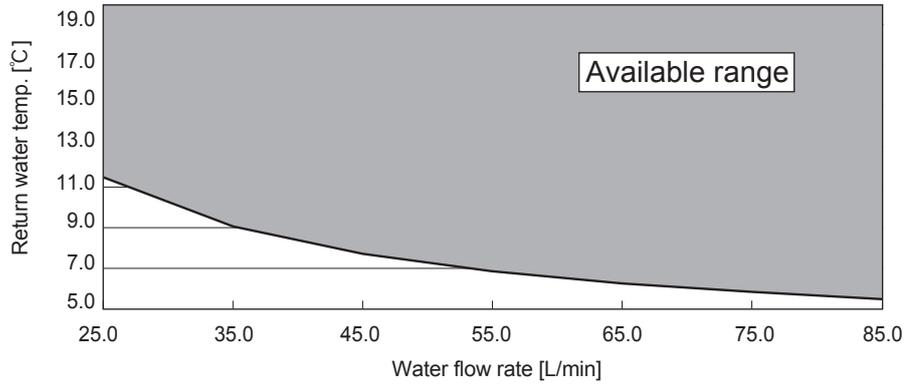

PUHZ-SHW230YKA2

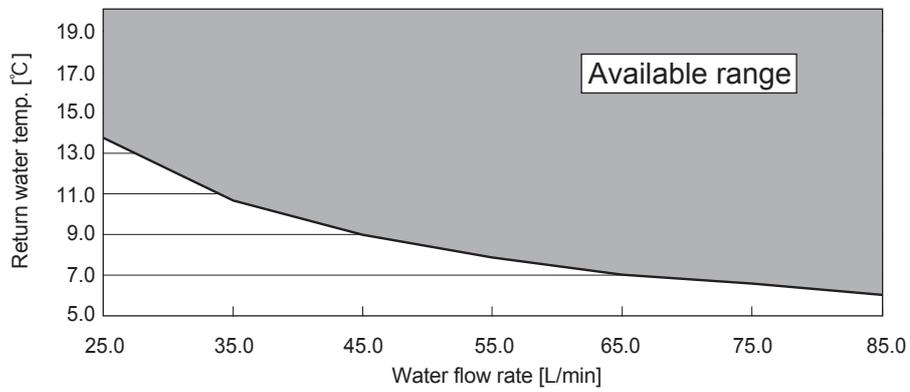

2.1 Packaged-type units

■ PUAZ-W50VHA2(-BS)

Unit : mm

Outdoor unit

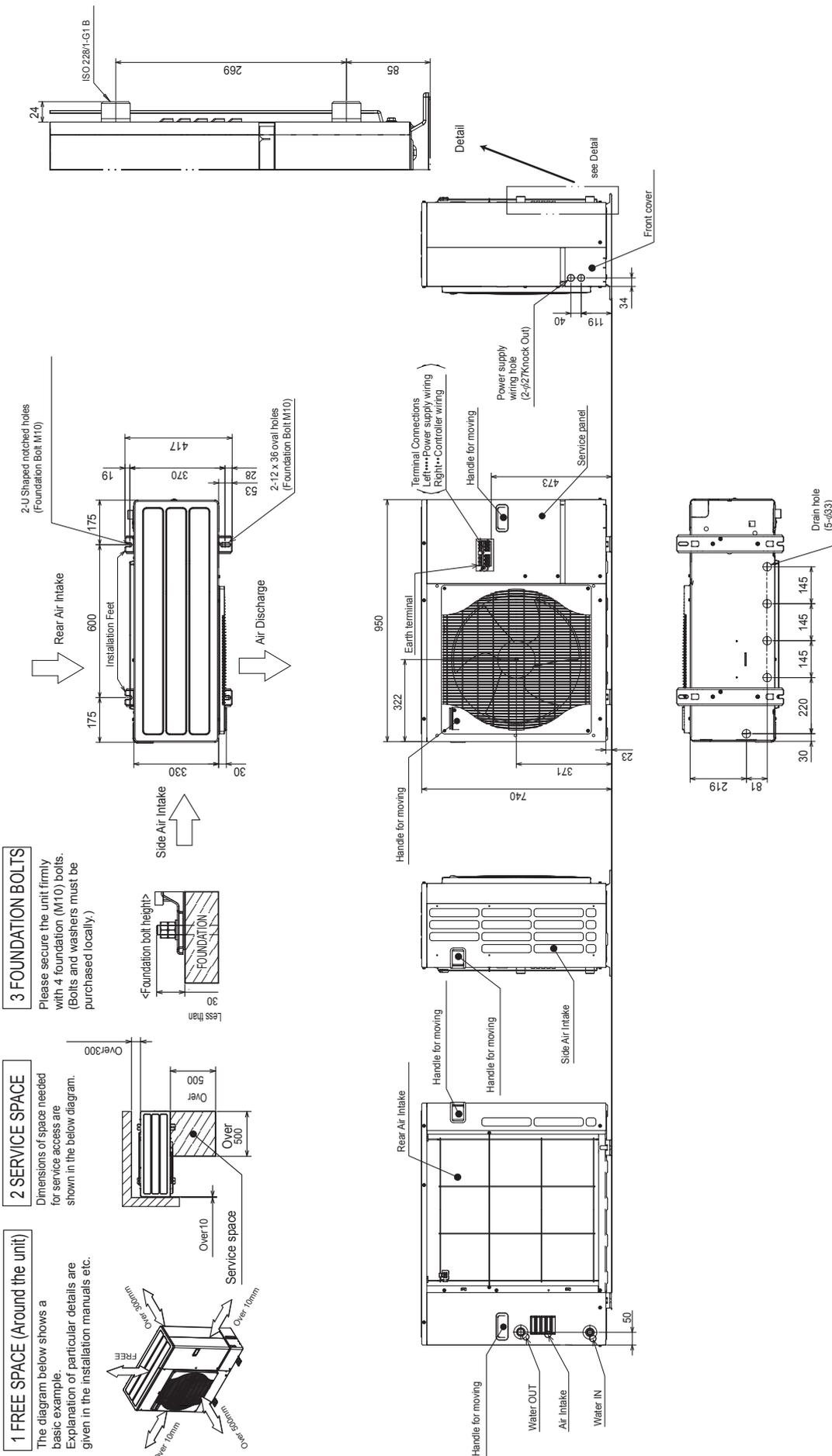

PUHZ-W85VHA2(-BS)

Unit : mm

Outdoor unit

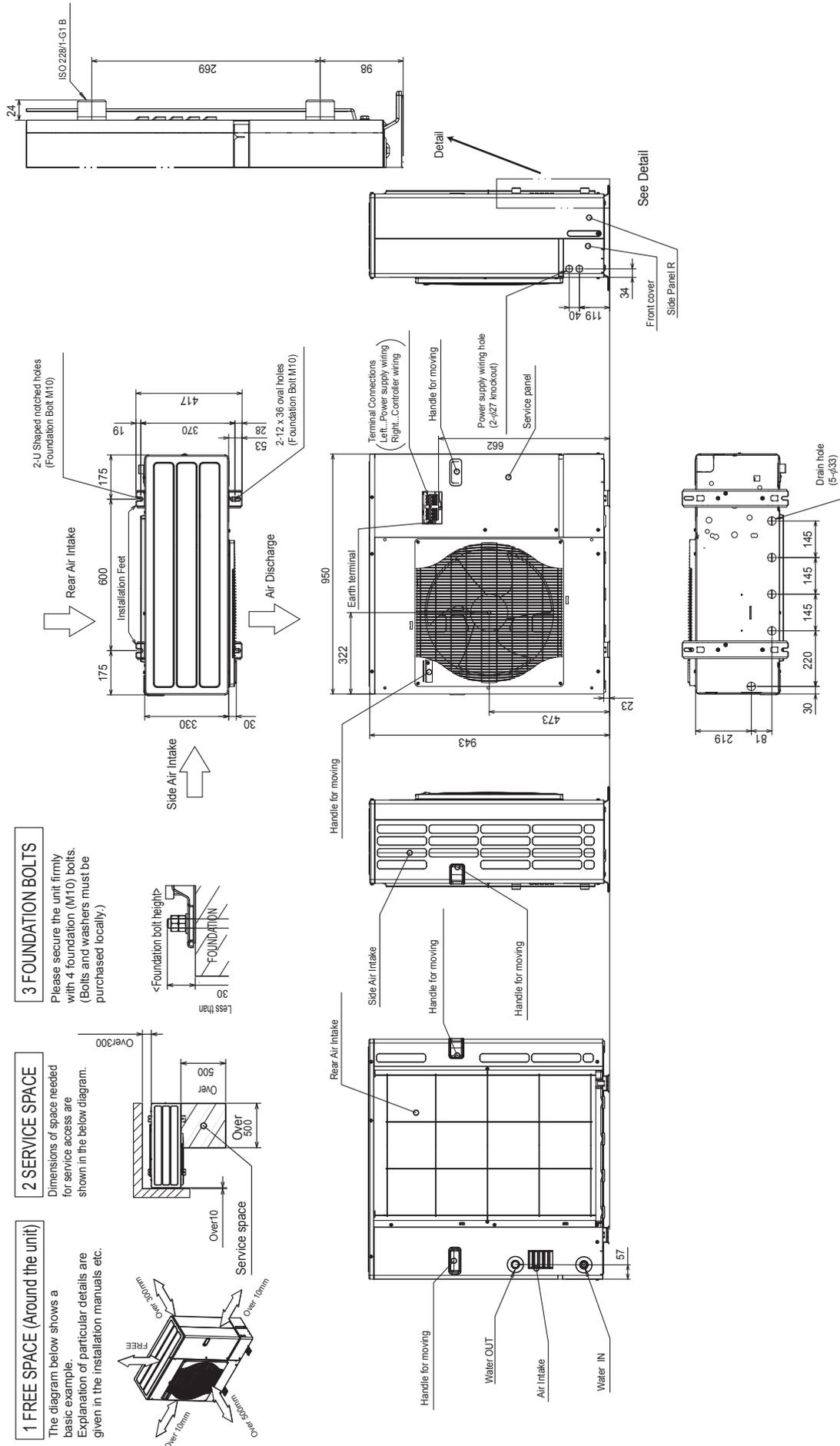

■ PUAZ-W112VHA(-BS)

PUAZ-HW112YHA2(-BS)

PUAZ-HW140V/YHA2(-BS)

Unit : mm

Outdoor unit

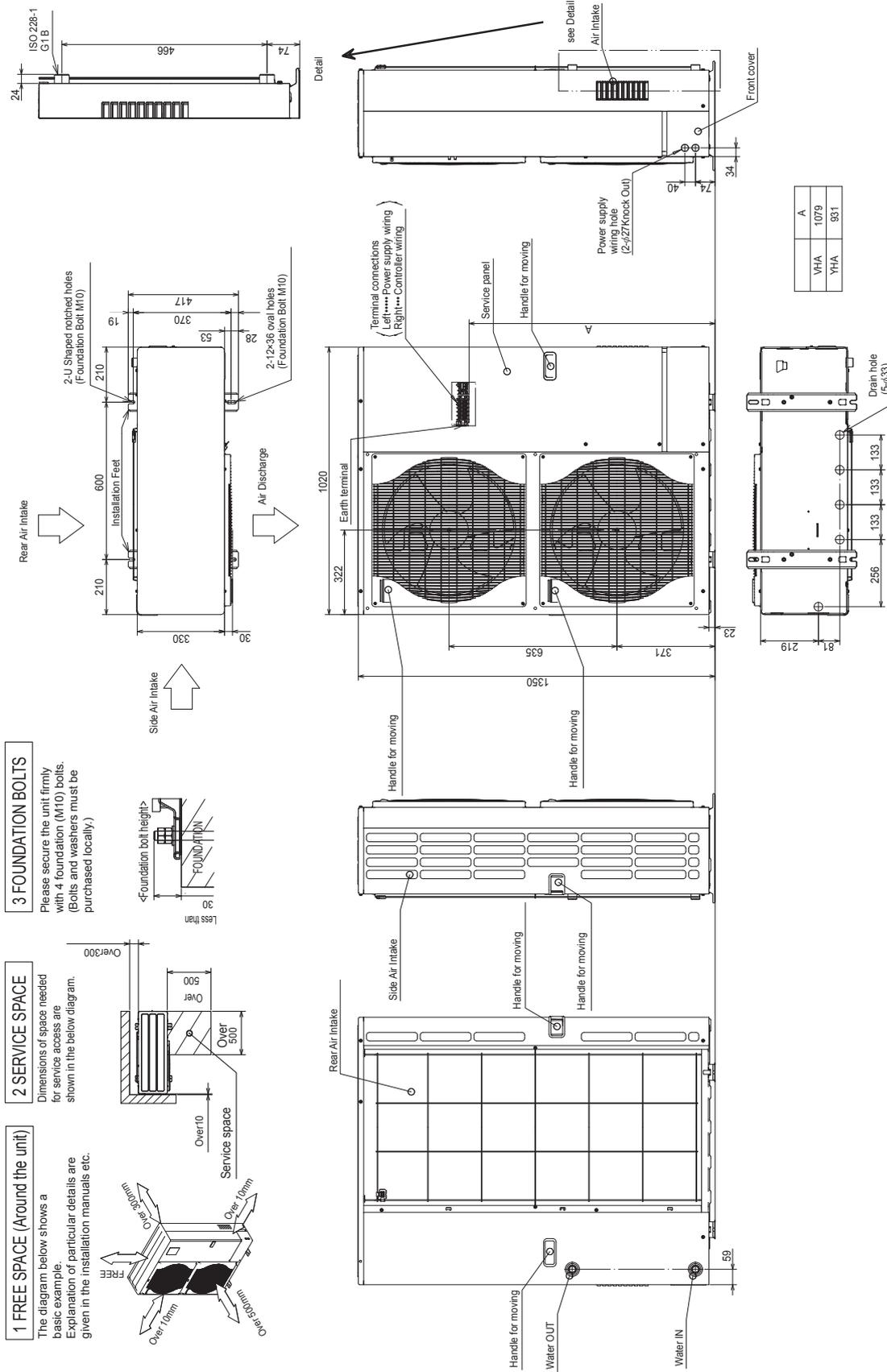

2.2 Split-type units

■ SUHZ-SW45VA(H)

Unit : mm

Outdoor unit

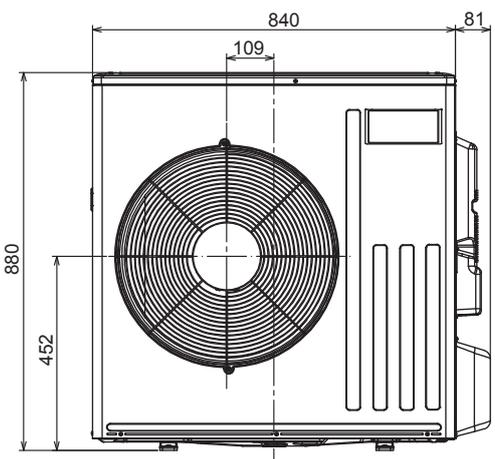
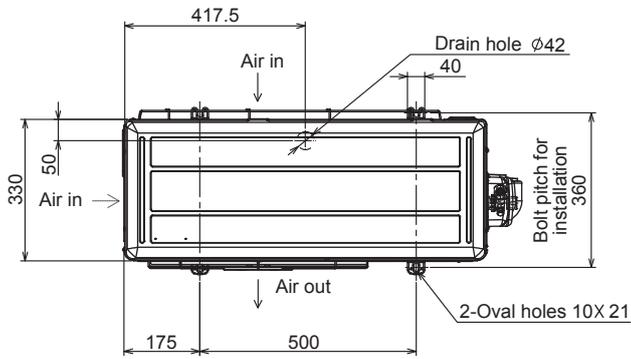

REQUIRED SPACE
Basically, leave this space open. Only if front and both sides are open, leave 500 mm at minimum.

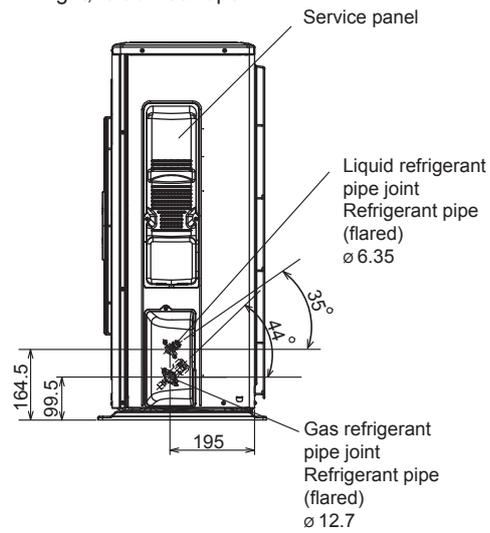
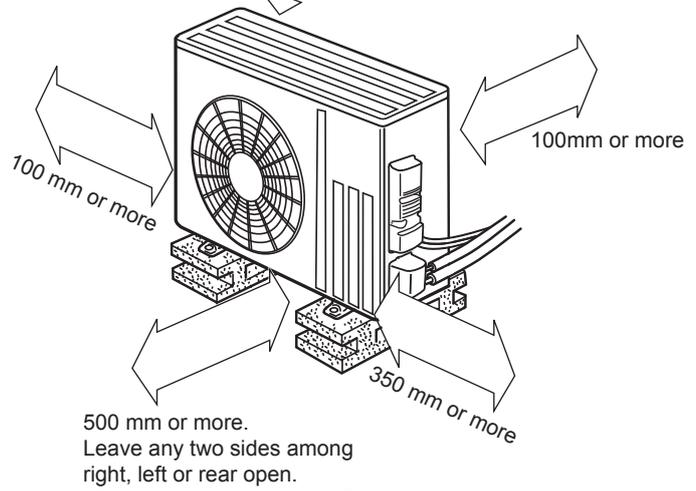

■ PUAZ-SW50VKA(-BS)

Unit : mm

Outdoor unit

Free space around the outdoor unit (basic example)

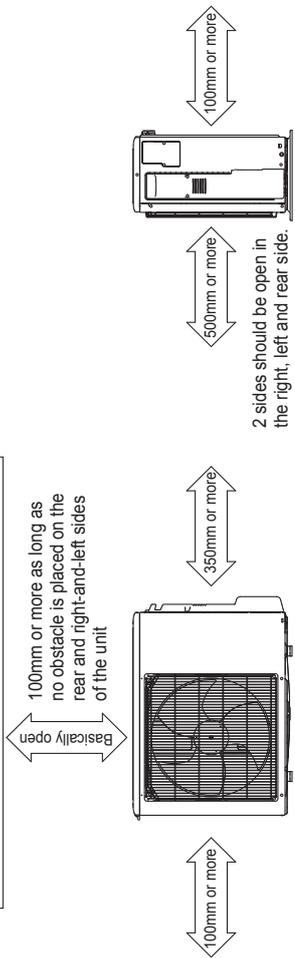

FOUNDATION BOLTS

Please secure the unit firmly with 4 foundation (M10) bolts. (Bolts, washers and nut must be purchased locally).

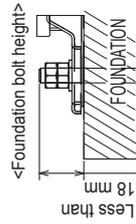

PIPING-WIRING DIRECTION

Piping and wiring connection can be made from the rear direction only.

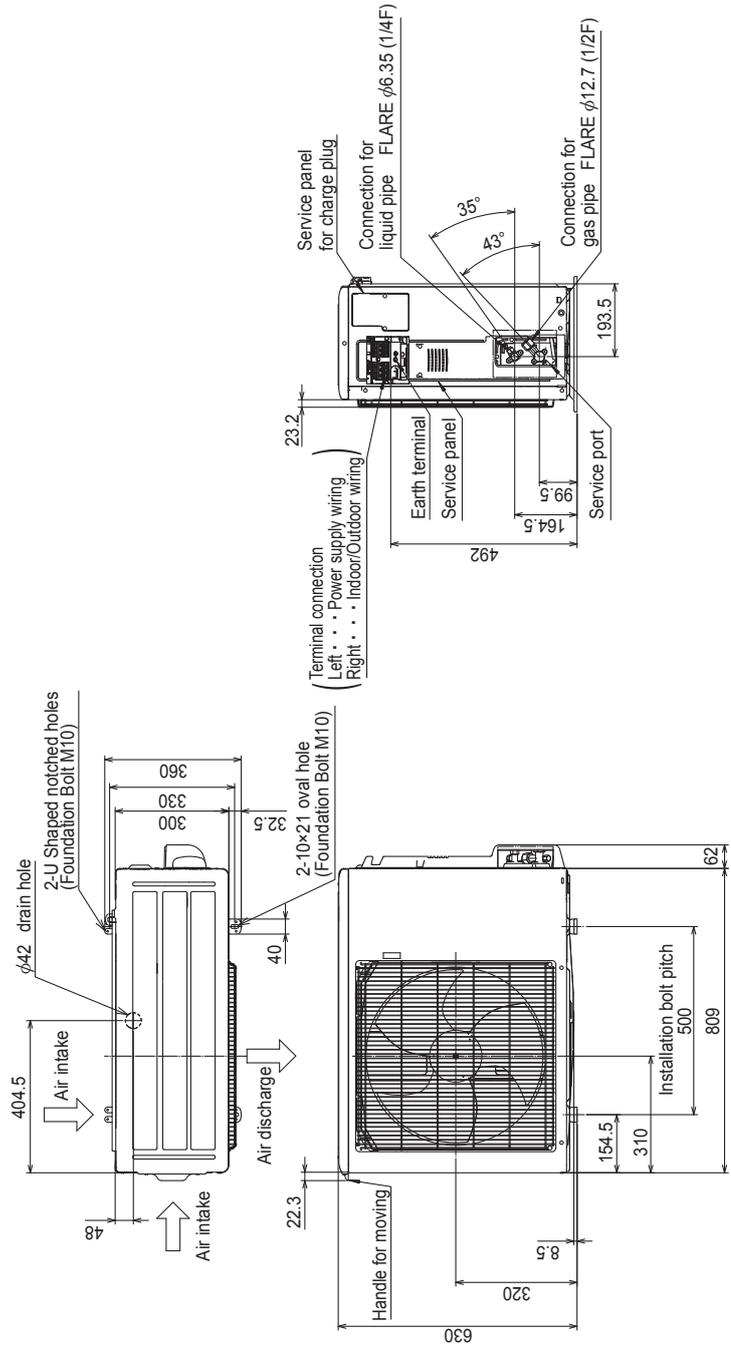

2 Outlines and dimensions

Outdoor unit

- PUAZ-SW100/120VHA(-BS)
- PUAZ-SW100/120YHA(-BS)
- PUAZ-SHW80/112VHA(-BS)
- PUAZ-SHW112YHA(-BS)

Unit : mm

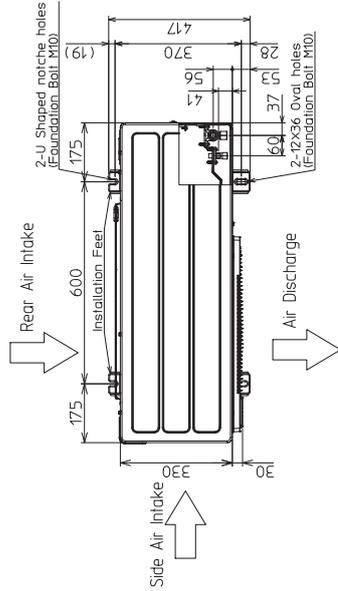

4 PIPING-WIRING DIRECTIONS

Piping and wiring connections can be made from 4 directions: FRONT, Right, Rear and Below.

3 FOUNDATION BOLTS

Please secure the unit firmly with 4 foundation (M10) bolts. (Bolts and washers must be purchased locally)

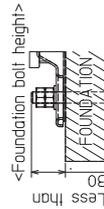

2 SERVICE SPACE

Dimensions of space needed for service access are shown in the below diagram.

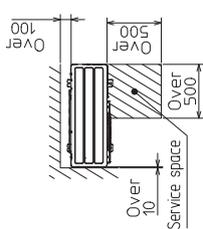

1 FREE SPACE (Around the unit)

The diagram below shows a basic example. Explanation of particular details are given in the installation manuals etc.

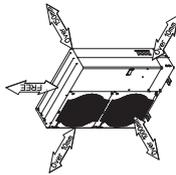

Example of Notes

- ① ... Refrigerant GAS pipe connection (FLARE) (5.88 (5/8F))
- ② ... Refrigerant LIQUID pipe connection (FLARE) (6.952 (3/8F))
- ※1 ... Indication of STOP VALVE connection location.

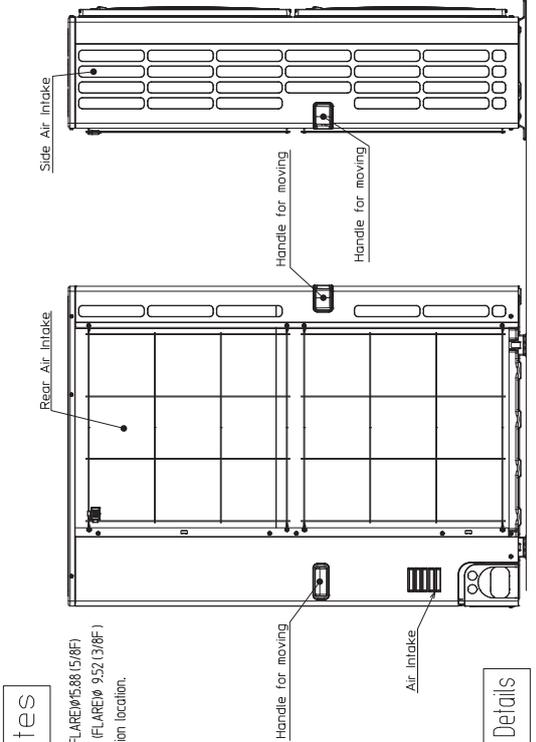
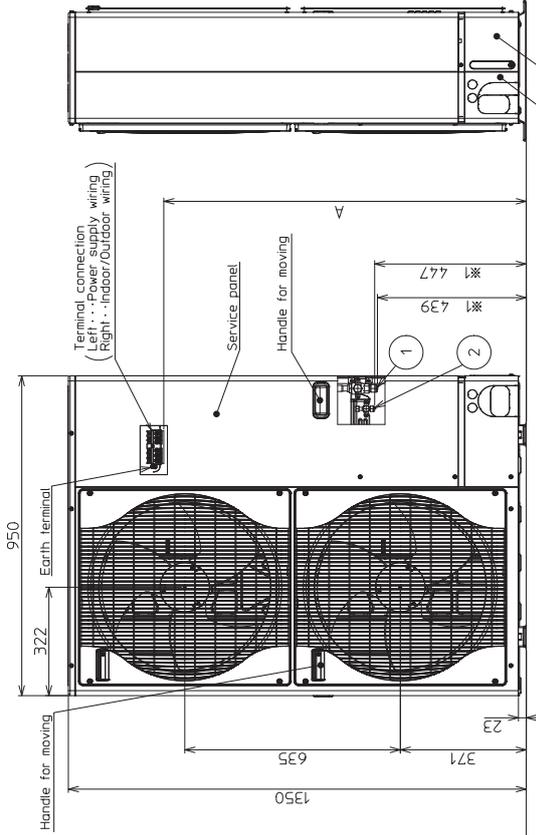

Piping Knock-Out Hole Details

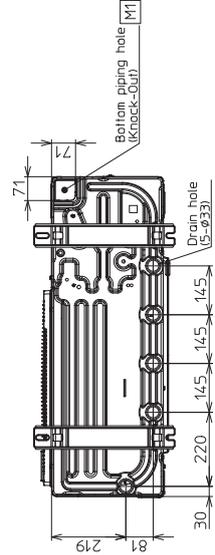
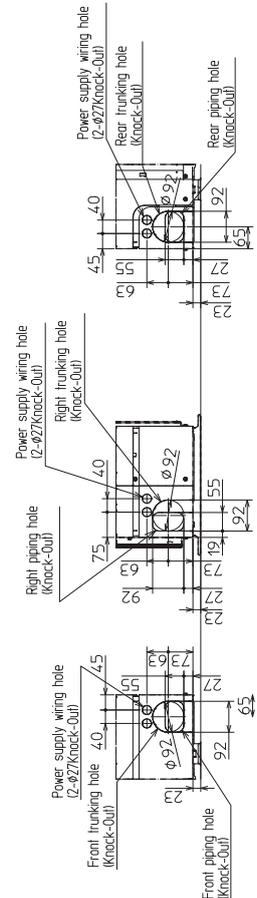

A	1,076
VHA	931
YHA	931

PUHZ-SW160/200YKA(-BS)

Unit : mm

Outdoor unit

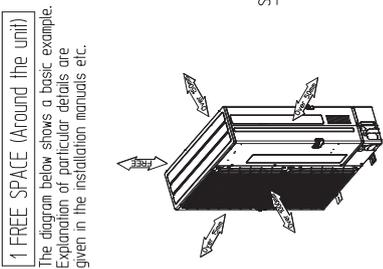
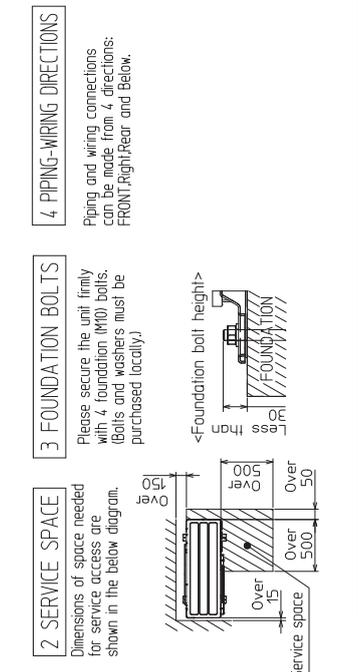
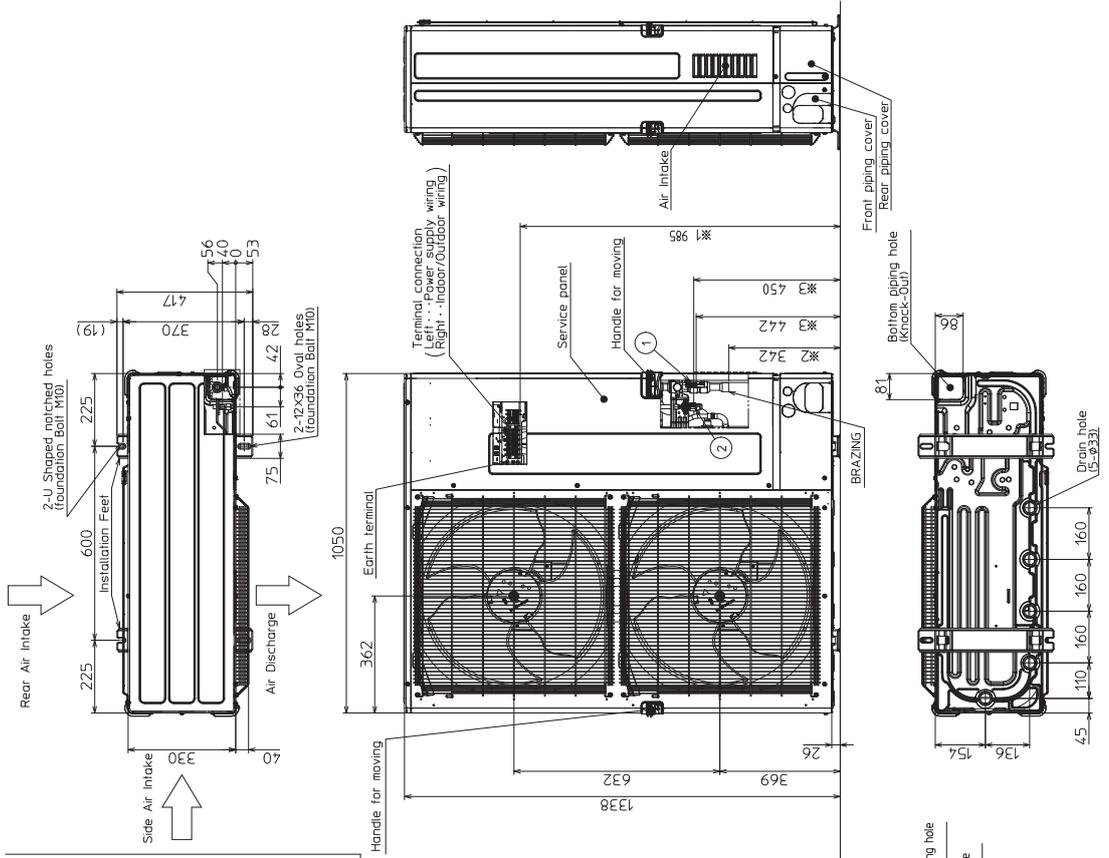

Example of Notes

Model	① Refrigerant GAS pipe connection	② Refrigerant LIQUID pipe connection
PUHZ-SW160YKA	φ19.05 (3/4F)	φ9.52 (3/8F)
PUHZ-SW160YKA-BS	φ19.05 (3/4F)	φ9.52 (3/8F)
PUHZ-SW200YKA	φ19.05 (3/4F)	φ12.7 (1/2F)
PUHZ-SW200YKA-BS	φ19.05 (3/4F)	φ12.7 (1/2F)

※...Indication of Terminal connection location.
 ※...Refrigerant GAS PPE connection (BRAZING) 0.0025.4.
 ※...Indication of STOP VALVE connection location.

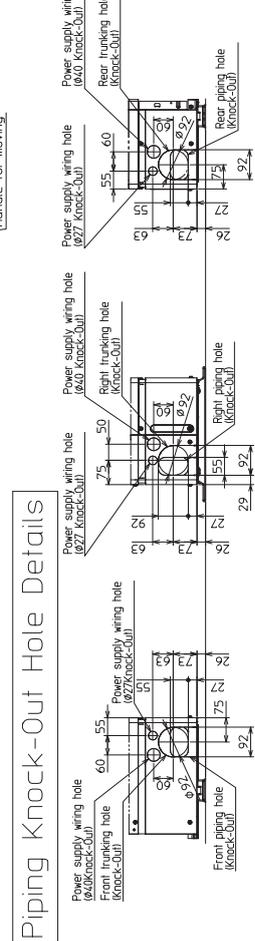

■ PUHZ-SHW230YKA2

Unit : mm

Outdoor unit

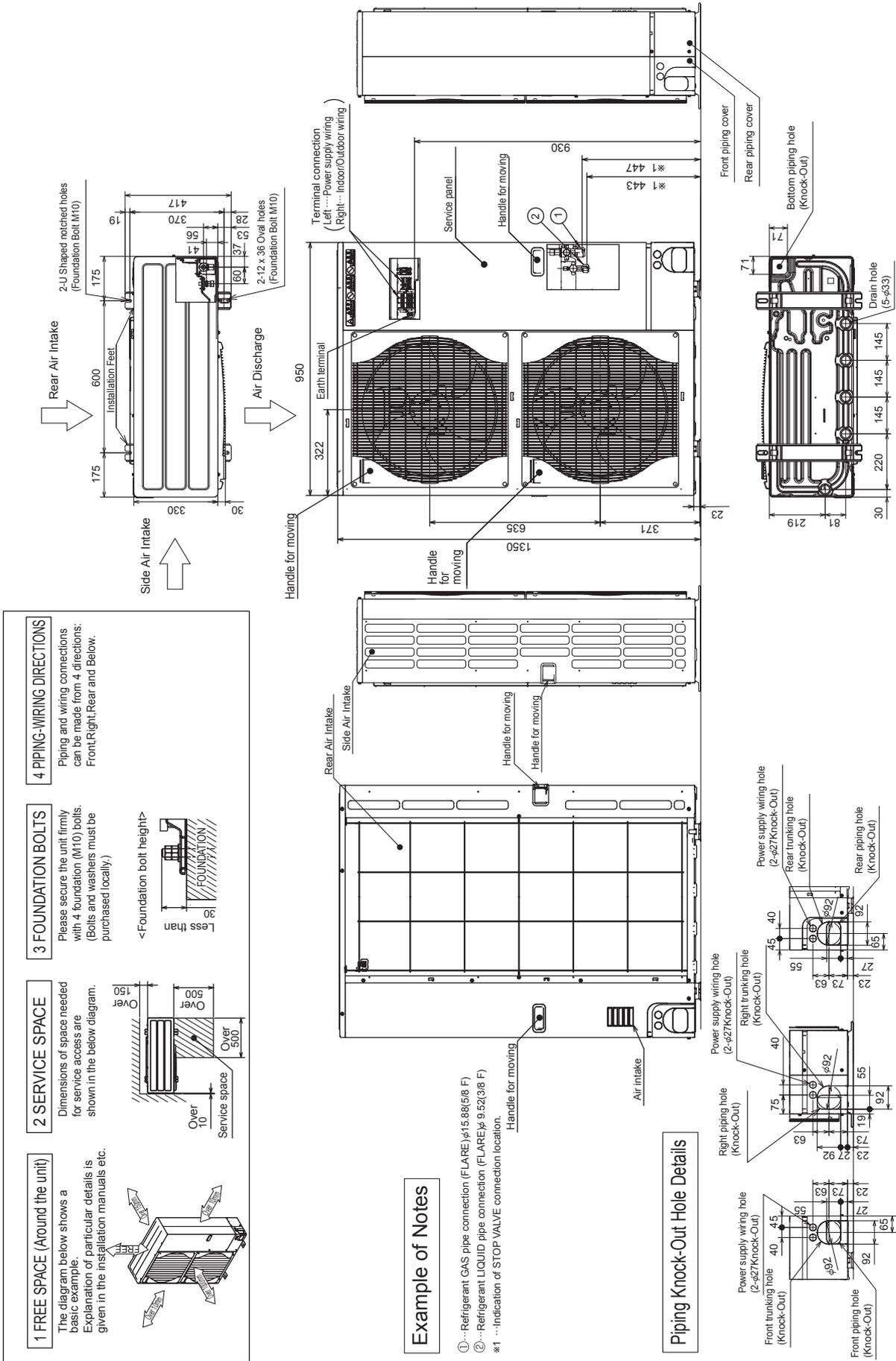

■ PUHZ-FRP71VHA2

Unit : mm

Outdoor unit

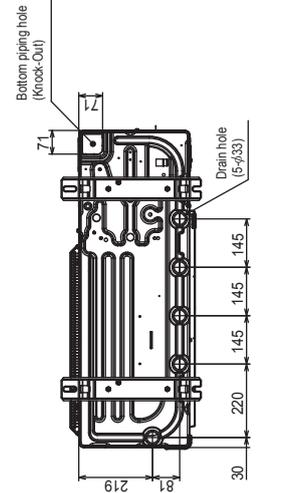
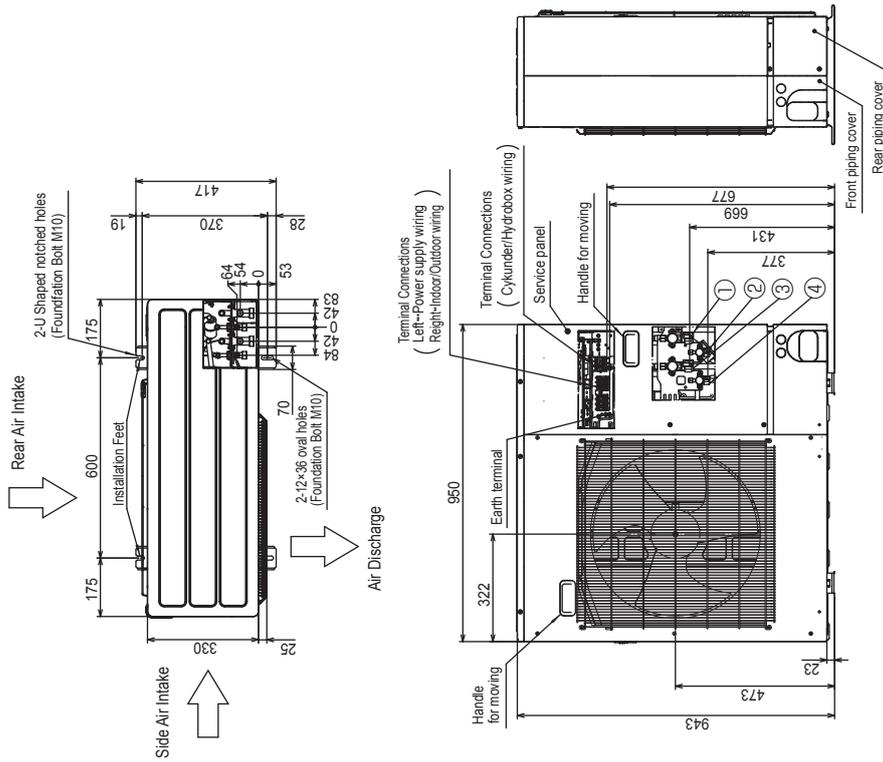

4 PIPING-WIRING DIRECTIONS

Piping and wiring connections can be made from 4 directions: FRONT, Right, Rear and Below.

3 FOUNDATION BOLTS

Please secure the unit firmly with 4 foundation (M10) bolts. (Bolts and washers must be purchased locally)

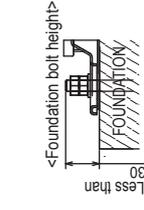

2 SERVICE SPACE

Dimensions of space needed for service access are shown in the below diagram.

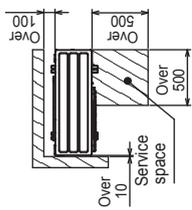

1 FREE SPACE (Around the unit)

The diagram below shows a basic example. Explanation of particular details are given in the installation manuals etc.

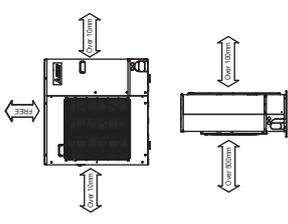

Example of Notes

- ① ...Refrigerant GAS pipe connection (FLARE) φ 15.88(5/8F)
*Connect to indoor unit.
- ② ...Refrigerant LIQUID pipe connection (FLARE) φ 9.52(3/8F)
*Connect to indoor unit.
- ③ ...Refrigerant GAS pipe connection (FLARE) φ 15.88(5/8F)
*Connect to cylinder unit or hydrobox.
- ④ ...Refrigerant LIQUID pipe connection (FLARE) φ 9.52(3/8F)
*Connect to cylinder unit or hydrobox.

This tap mark indicates the cylinder/hydro unit connection side for the following parts.
 *Terminal bed for the connecting cables, S1/S2/S3.
 *Stop valves, gas and liquid for the refrigerant connection.

Piping Knock-Out Hole Details

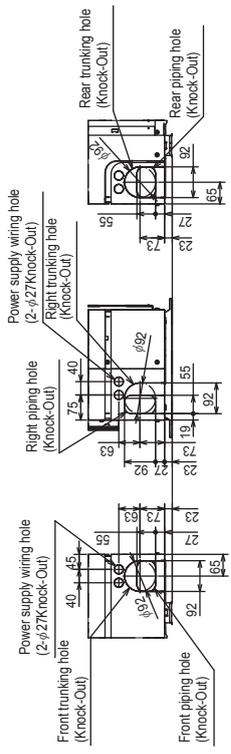

■ PUMY-P112/125/140YKM4(-BS)
PUMY-P112/125/140YKME4(-BS)

Unit : mm

Outdoor unit

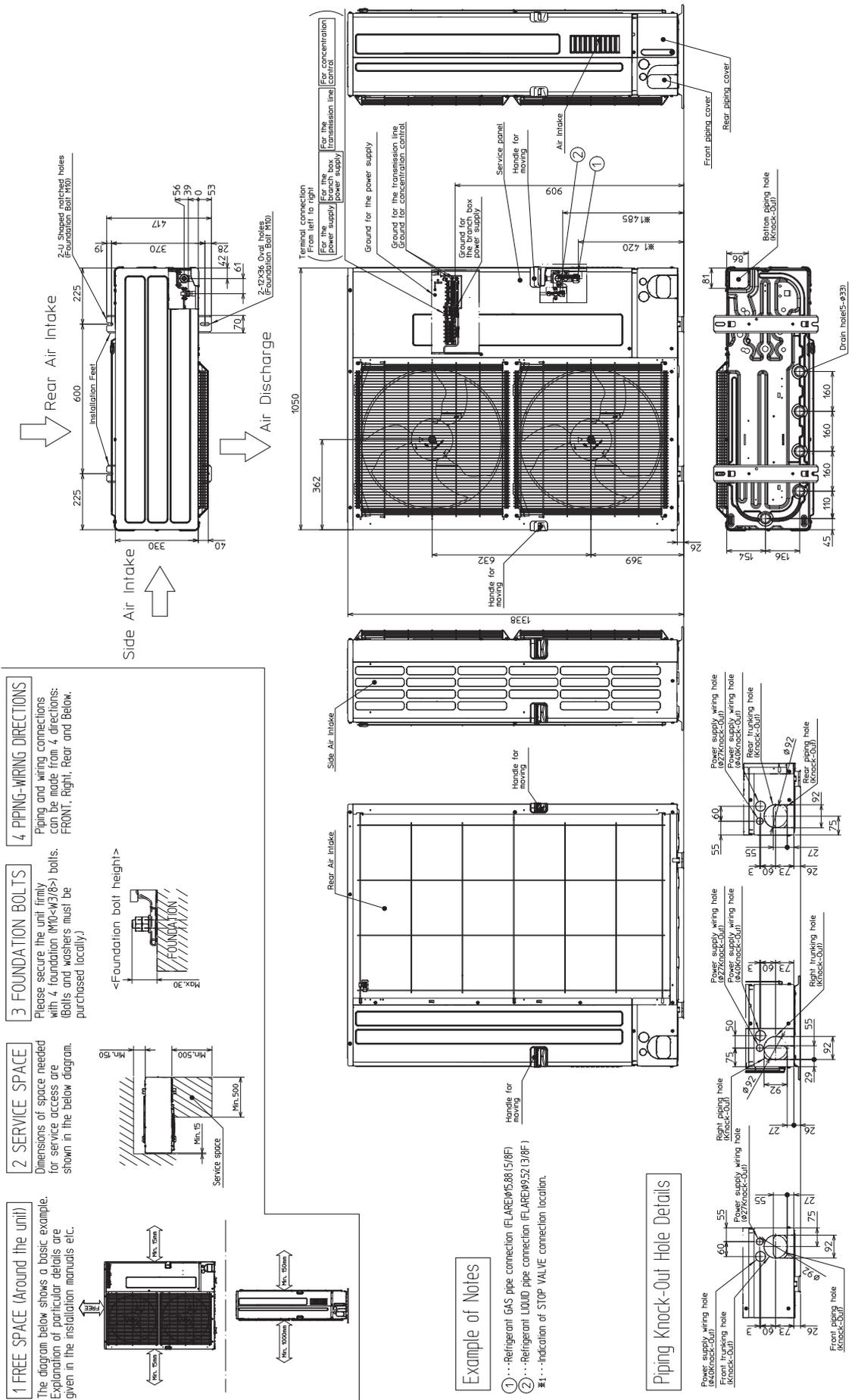

4 PIPING-WIRING DIRECTIONS
Piping and wiring connections can be made from 4 directions: FRONT, Right, Rear and Below.

3 FOUNDATION BOLTS
Please secure the unit firmly with 4 foundation (M10xM3/6) bolts. (Bolts and washers must be purchased locally.)

2 SERVICE SPACE
Dimensions of space needed for service access are shown in the below diagram.

1 FREE SPACE (Around the unit)
The diagram below shows a basic example. Explanation of particular details are given in the installation manuals etc.

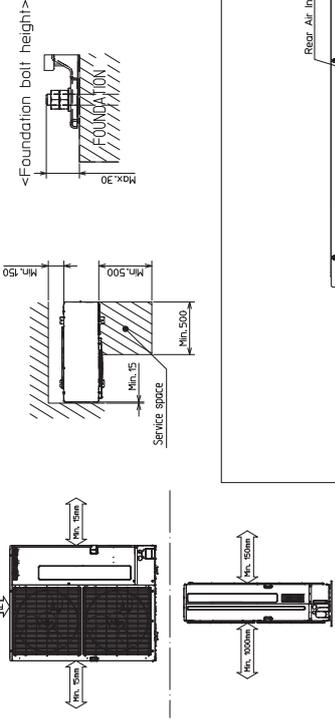

Example of Notes

- ① Refrigerant GAS pipe connection (FLARE) M5.88 (15/8F)
- ② Refrigerant LIQUID pipe connection (FLARE) M5.52 (3/8F)

※1... indication of STOP VALVE connection location.

Piping Knock-Out Hole Details

3.1 Packaged-type units

■ PUAZ-W50VHA2(-BS)

SYMBOL	NAME	SYMBOL	NAME
TB1	Terminal Block <Power Supply, Indoor/Outdoor>	C. B.	Controller Circuit Board
MC	Motor for Compressor	F1, F2	Fuse<T10AL250V>
MF1	Fan Motor	F3, F4	Fuse<T6.3AL250V>
21S4	Solenoid Valve(4-Way Valve)	SW1	Switch <Manual Defrost, Defect History Record Reset, Function Switch>
63H	High Pressure Switch	SW2	Switch<Function Switch>
63HS	High Pressure Sensor	SW4	Switch<Function Switch>
TH3	Thermistor<Liquid>	SW5	Switch<Function Switch, Model Select>
TH4	Thermistor<Discharge>	SW6	Switch<Model Select>
TH6	Thermistor<Plate HEX Liquid>	SW7	Switch<Function Switch>
TH7	Thermistor<Ambient>	SW8	Switch<Function Switch>
TH8	Thermistor<Heat Sink>	SW9	Switch<Function Switch>
TH32	Thermistor<Inlet Water>	CNDM	Connector<Connection for Option>
TH34	Thermistor<Comp. Surface>	SV1/CH	Connector<Connection for Option>
LEV-A, LEV-B	Linear Expansion Valve	SV3/SS	Connector<Connection for Option>
ACL	Reactor		
CY1, CY2	Capacitor		
P. B.	Power Circuit Board		

*1 MODEL SELECT
The black square (■) indicates a switch position.

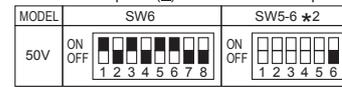

*2 SW5-1 to 5 : Function Switch

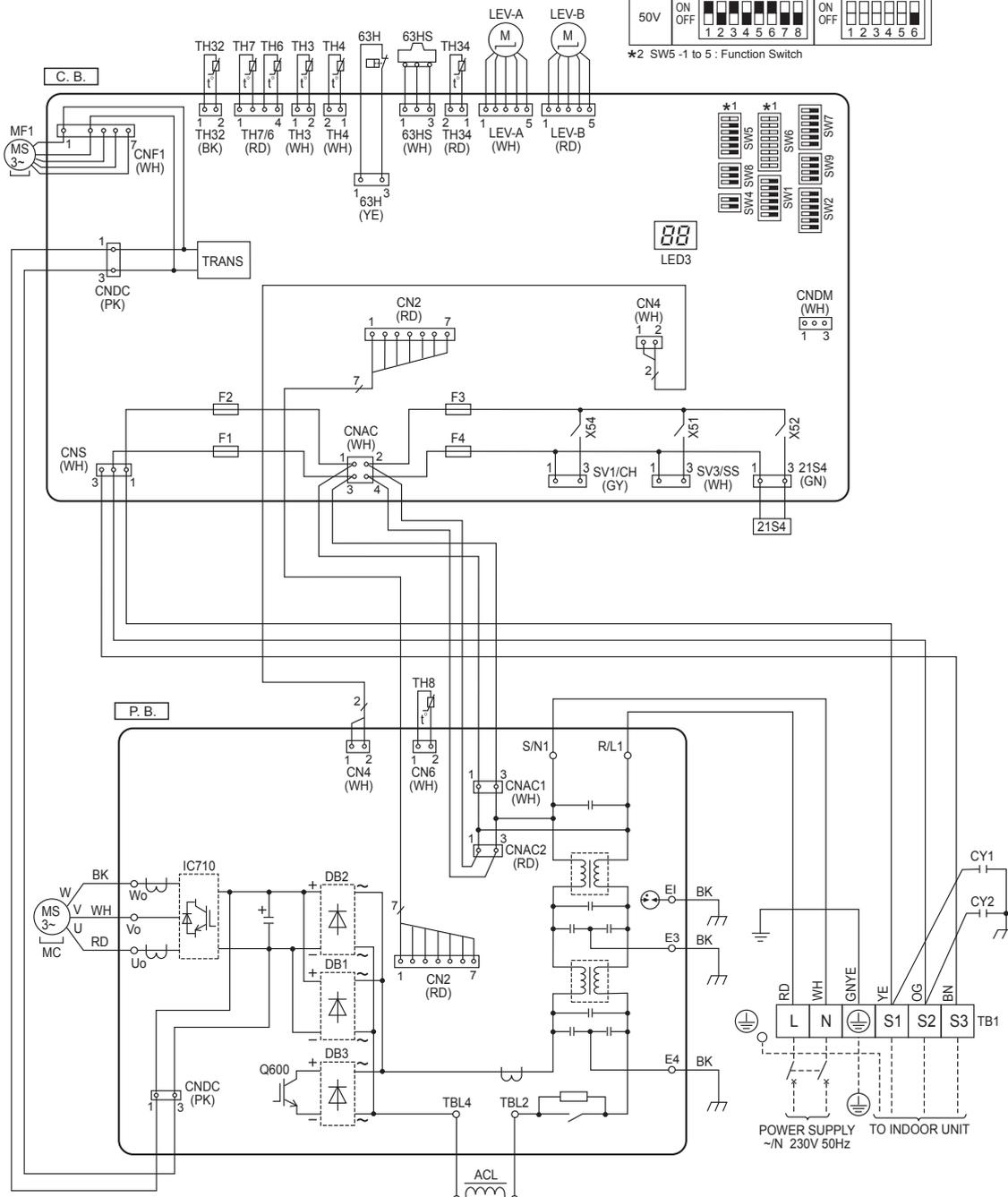

PUHZ-W85VHA2(-BS)

Outdoor unit

SYMBOL	NAME	SYMBOL	NAME
TB1	Terminal Block <Power Supply, Indoor/Outdoor>	ACTM	Active Filter Module
MC	Motor for Compressor	CY1, CY2	Capacitor
MF1	Fan Motor	P. B.	Power Circuit Board
21S4	Solenoid Valve (4-Way Valve)	N. F.	Noise Filter Circuit Board
SV	Solenoid Valve (Bypass Valve)	C. B.	Controller Circuit Board
63H	High Pressure Switch	F1, F2, F3, F4	Fuse <T6.3AL250V>
63HS	High Pressure Sensor	SW1	Switch <Manual Defrost, Defect History Record Reset, Function Switch>
TH3	Thermistor <Liquid>	SW2	Switch <Function Switch>
TH4	Thermistor <Discharge>	SW5	Switch <Function Switch, Model Select>
TH6	Thermistor <Plate HEX Liquid>	SW6	Switch <Model Select>
TH7	Thermistor <Ambient>	SW7	Switch <Function Switch>
TH8	Thermistor <Heat Sink>	SW8	Switch <Function Switch>
TH32	Thermistor <Inlet Water>	SW10	Switch <Function Switch, Model Select>
TH33	Thermistor <Comp. Surface>	CNDM	Connector <Connection for Option>
LEV-A, LEV-B	Linear Expansion Valve	SV1	Connector <Connection for Option>
DCL	Reactor		

★1 MODEL SELECT
The black square (■) indicates a switch position.

MODEL	SW5-4 ★2	SW6	SW10-2 ★2
85V	ON OFF ■ ■ ■ ■	ON OFF ■ ■ ■ ■ ■ ■	ON OFF ■ ■
	1 2 3 4	1 2 3 4 5 6	1 2

★2 SW5 -1 to 3: Function Switch
SW10 -1 : Function Switch

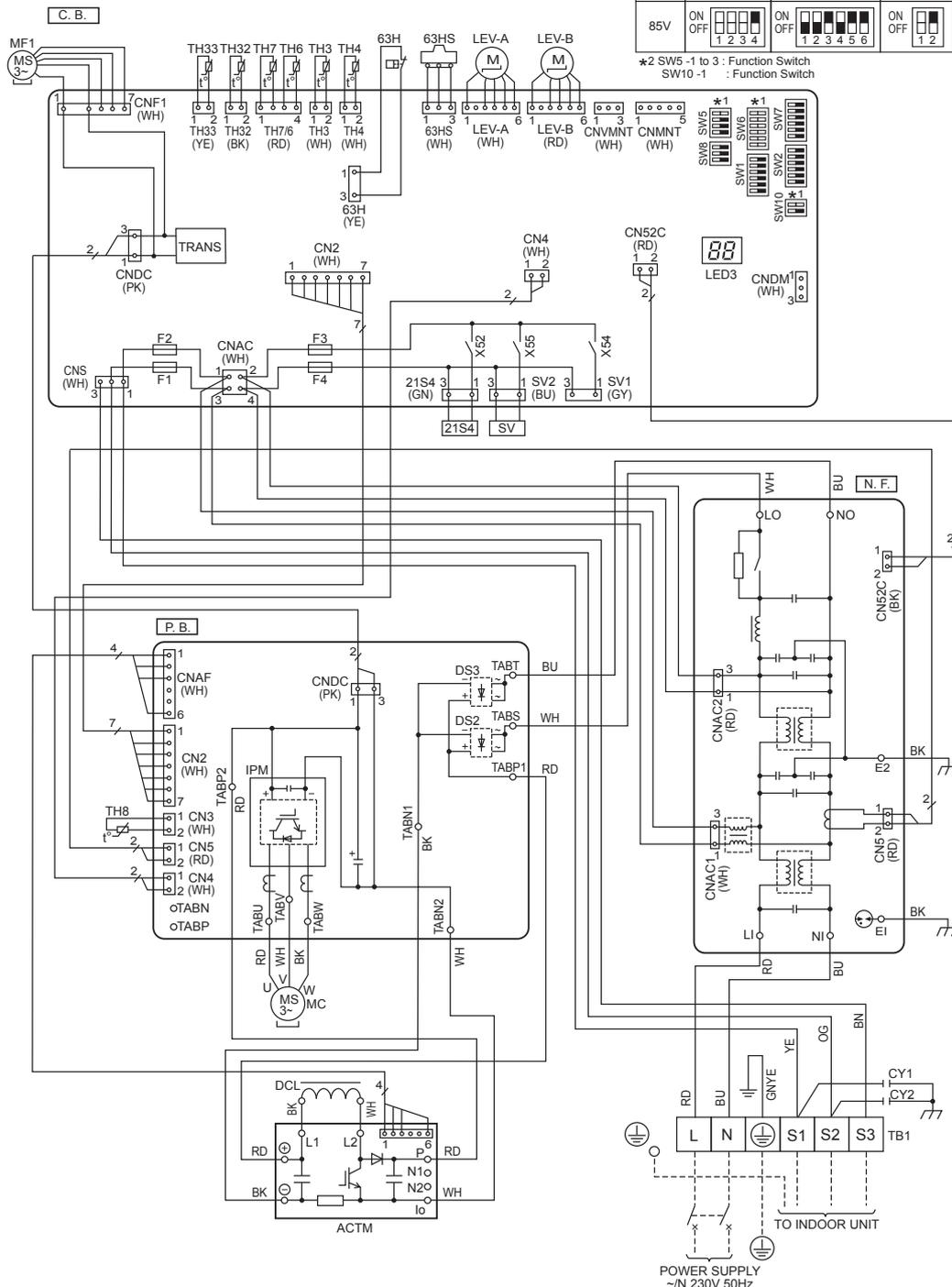

PUHZ-W112VHA(-BS)

SYMBOL	NAME	SYMBOL	NAME
TB1	Terminal Block<Power Supply, Indoor/Outdoor>	CY1, CY2	Capacitor
MC	Motor for Compressor	P. B.	Power Circuit Board
MF1, MF2	Fan Motor	C. B.	Controller Circuit Board
21S4	Solenoid Valve(4-Way Valve)	SW1	Switch<Manual Defrost, Defect History Record Reset, Function Switch>
63H	High Pressure Switch	SW2	Switch<Function Switch>
63L	Low Pressure Switch	SW4	Switch<Function Switch>
63HS	High Pressure Sensor	SW5	Switch<Function Switch, Model Select>
TH3	Thermistor<Liquid>	SW6	Switch<Model Select>
TH4	Thermistor<Discharge>	SW7	Switch<Function Switch>
TH6	Thermistor<Plate HEX Liquid>	SW8	Switch<Function Switch>
TH7	Thermistor<Ambient>	SW9	Switch<Function Switch>
TH8	Thermistor internal<Heat Sink>	SV1/CH	Connector<Connection for Option>
TH32	Thermistor<Inlet Water>	SV3/SS	Connector<Connection for Option>
TH33	Thermistor<Suction>	CNDM	Connector <Connection for Option>
TH34	Thermistor<Comp. Surface>	F1, F2	Fuse<T10AL250V>
LEV-A, LEV-B	Linear Expansion Valve	F3, F4	Fuse<T6.3AL250V>
DCL	Reactor		

*1 MODEL SELECT
The black square indicates a switch position.

MODEL	SW6	SW5-6 *2
112V	ON OFF	ON OFF
	1 2 3 4 5 6 7 8	1 2 3 4 5 6

*2 SW5 -1 to 5 : Function Switch

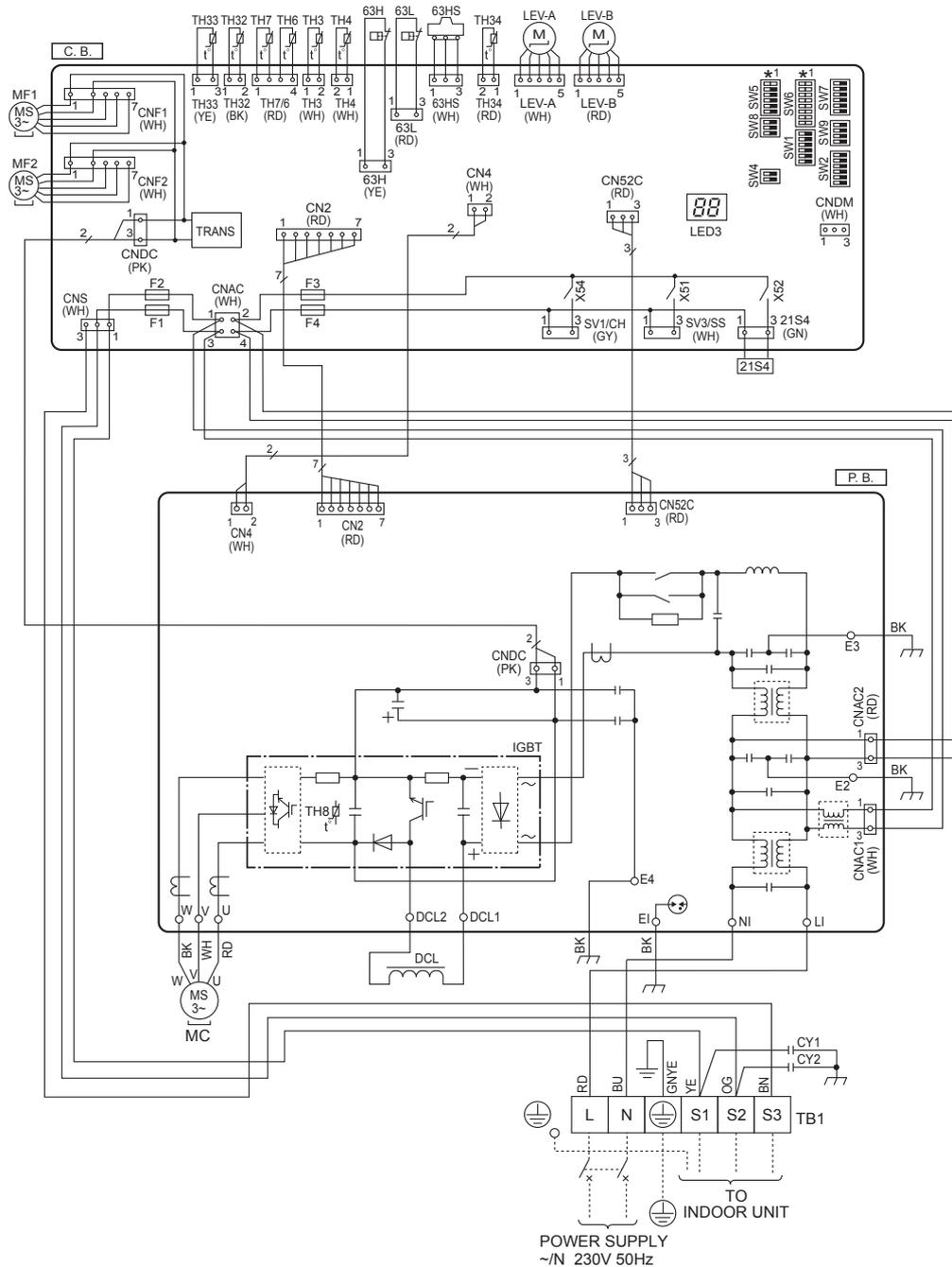

■ PUAZ-W85VAA

PUHZ-W112VAA

Outdoor unit

SYMBOL	NAME	SYMBOL	NAME
TB1	Terminal Block <Power Supply, Indoor/Outdoor>	CY1, CY2	Capacitor
MC	Motor for Compressor	P.B.	Power Circuit Board
MF1	Fan Motor	C.B.	Controller Circuit Board
21S4	Solenoid Valve (4-Way Valve)	SW1	Switch <Manual Defrost, Defect History Record Reset, Refrigerant Address>
63H	High Pressure Switch	SW2	Switch <Function Switch>
63L	Low Pressure Switch	SW4	Switch <Function Switch>
63HS	High Pressure Sensor	SW5	Switch <Function Switch>
TH3	Thermistor <Liquid>	SW6	Switch <Function Switch, Model Select>
TH4	Thermistor <Discharge>	SW7	Switch <Function Switch>
TH6	Thermistor <Plate Hex Liquid>	SW8	Switch <Function Switch>
TH7	Thermistor <Ambient>	SW9	Switch <Function Switch>
TH8	Thermistor <Heat Sink>	CNDM	Connector <Connection for Option>
TH33	Thermistor <Comp. Surface>	SV1/CH	Connector <Connection for Option>
TH34	Thermistor <Inlet Water>	SV3/SS	Connector <Connection for Option>
LEV-A, LEV-B	Linear Expansion Valve	F1, F2, F3, F4	Fuse <T6.3AL250V>
DCL1, DCL2, DCL3	Reactor		

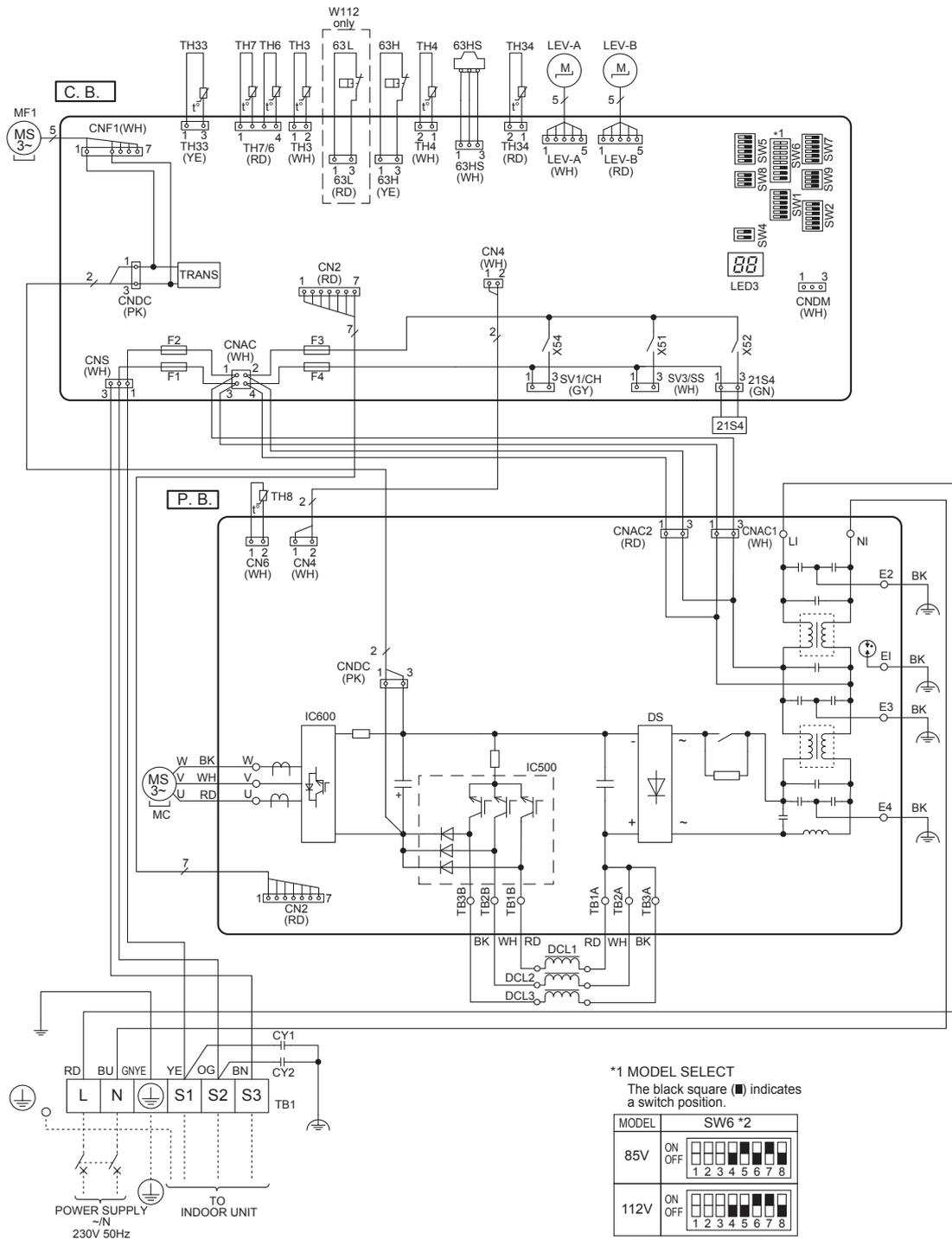

■ PUAZ-W85YAA

PUAZ-W112YAA

SYMBOL	NAME	SYMBOL	NAME
TB1	Terminal Block <Power Supply>	P. B.	Power Circuit Board
TB2	Terminal Block <Indoor/Outdoor>	N. F.	Noise Filter Circuit Board
MC	Motor for Compressor	CONV. B.	Converter Circuit Board
MF1	Fan Motor	C. B.	Controller Circuit Board
21S4	Solenoid Valve (4-Way Valve)	SW1	Switch <Manual Defrost, Defect History Record Reset, Refrigerant Address>
63H	High Pressure Switch	SW2	Switch <Function Switch>
63L	Low Pressure Switch	SW4	Switch <Function Switch>
63HS	High Pressure Sensor	SW5	Switch <Function Switch>
TH3	Thermistor <Liquid>	SW6	Switch <Function Switch, Model Select>
TH4	Thermistor <Discharge>	SW7	Switch <Function Switch>
TH6	Thermistor <Plate Hex Liquid>	SW8	Switch <Function Switch>
TH7	Thermistor <Ambient>	SW9	Switch <Function Switch>
TH8	Thermistor <Heat Sink>	CNDM	Connector <Connection for Option>
TH33	Thermistor <Comp. Surface>	SV1/CH	Connector <Connection for Option>
TH34	Thermistor <Inlet Water>	SV3/SS	Connector <Connection for Option>
LEV-A, LEV-B	Linear Expansion Valve	F1, F2, F3, F4	Fuse <T6.3AL250V>
ACL1, ACL2, ACL3, ACL4	Reactor		
CY1, CY2	Capacitor		
CK	Capacitor		
RS	Rush Current Protect Resistor		

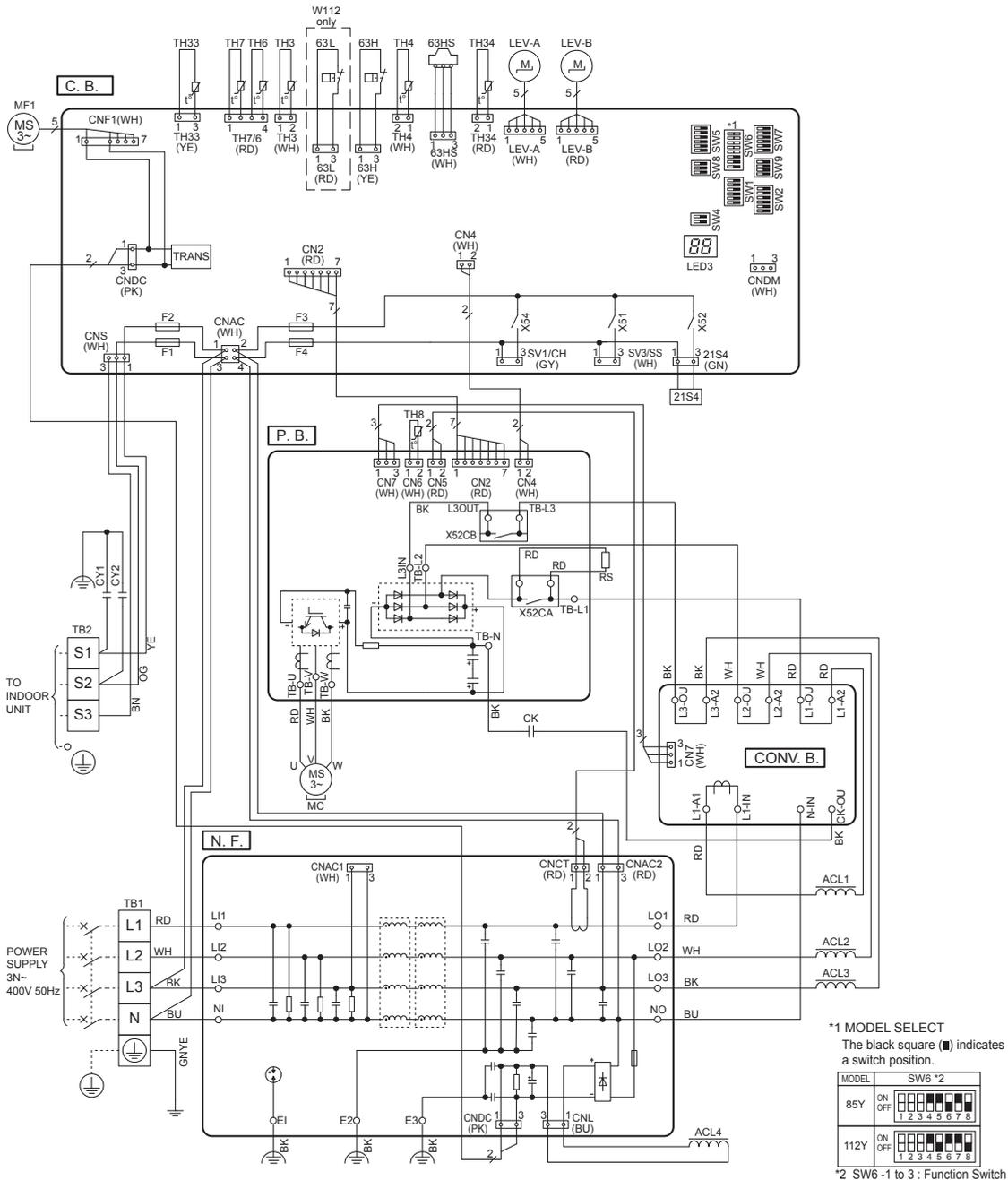

PUHZ-HW112/140YHA2(-BS)

Outdoor unit

SYMBOL	NAME	SYMBOL	NAME
TB1	Terminal Block<Power Supply>	RS	Rush Current Protect Resistor
TB2	Terminal Block<Indoor/Outdoor>	P. B.	Power Circuit Board
MC	Motor for Compressor	N. F.	Noise Filter Circuit Board
MF1, MF2	Fan Motor	CONV. B.	Converter Circuit Board
21S4	Solenoid Valve(4-Way Valve)	C. B.	Controller Circuit Board
63H	High Pressure Switch	SW1	Switch<Manual Defrost, Defect History Record Reset, Function Switch>
63L	Low Pressure Switch	SW2	Switch<Function Switch>
63HS	High Pressure Sensor	SW4	Switch<Function Switch>
TH3	Thermistor<Liquid>	SW5	Switch<Function Switch, Model Select>
TH4	Thermistor<Discharge>	SW6	Switch<Model Select>
TH6	Thermistor<Plate HEX Liquid>	SW7	Switch<Function Switch>
TH7	Thermistor<Ambient>	SW8	Switch<Function Switch>
TH8	Thermistor<Heat Sink>	SW9	Switch<Function Switch>
TH32	Thermistor<Inlet Water>	CNDM	Connector<Connection for Option>
TH33	Thermistor<Suction>	SV1/CH	Connector<Connection for Option>
TH34	Thermistor<Comp. Surface>	SV3/SS	Connector<Connection for Option>
LEV-A, LEV-B, LEV-C	Linear Expansion Valve	F1, F2	Fuse<T10AL250V>
ACL1, ACL2, ACL3, ACL4	Reactor	F3, F4	Fuse<T6.3AL250V>
CY1, CY2	Capacitor		
CK	Capacitor		

*1 MODEL SELECT

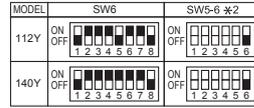

*2 SW5 -1 to 5 : Function Switch

*3 Ambient temp. of ZUBADAN Flash Injection becomes effective.

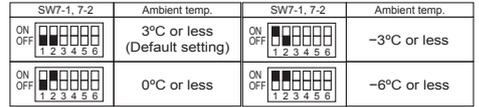

SW7-3 to 6 : Function Switch

The black square ■ indicates a switch position.

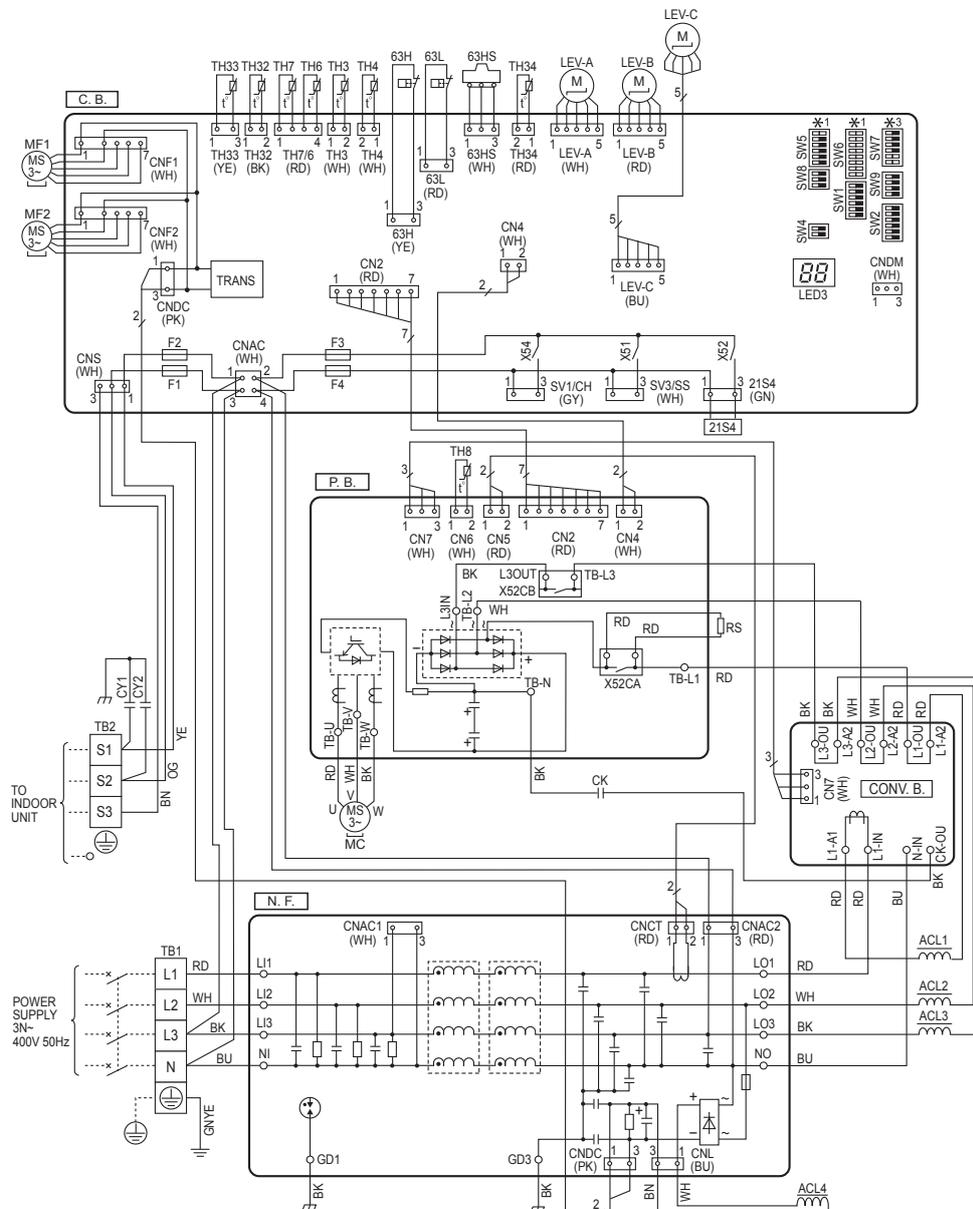

PUHZ-HW140VHA2(-BS)

SYMBOL	NAME	SYMBOL	NAME
TB1	Terminal Block<Power Supply, Indoor/Outdoor>	CY1, CY2	Capacitor
MC	Motor for Compressor	P. B.	Power Circuit Board
MF1, MF2	Fan Motor	C. B.	Controller Circuit Board
21S4	Solenoid Valve(4-Way Valve)	SW1	Switch<Manual Defrost, Defect History Record Reset, Function Switch>
63H	High Pressure Switch	SW2	Switch<Function Switch>
63L	Low Pressure Switch	SW4	Switch<Function Switch>
63HS	High Pressure Sensor	SW5	Switch<Function Switch, Model Select>
TH3	Thermistor<Liquid>	SW6	Switch<Model Select>
TH4	Thermistor<Discharge>	SW7	Switch<Function Switch>
TH6	Thermistor<Plate HEX Liquid>	SW8	Switch<Function Switch>
TH7	Thermistor<Ambient>	SW9	Switch<Function Switch>
TH8	Thermistor internal<Heat Sink>	SV1/CH	Connector<Connection for Option>
TH32	Thermistor<Inlet Water>	SV3/SS	Connector<Connection for Option>
TH33	Thermistor<Suction>	CNDM	Connector <Connection for Option>
TH34	Thermistor<Comp. Surface>	F1, F2	Fuse<T10AL250V>
LEV-A, LEV-B, LEV-C	Linear Expansion Valve	F3, F4	Fuse<T6.3AL250V>
DCL	Reactor		

*1 MODEL SELECT



*2 SW5-1 to 5 : Function Switch

*3 Ambient temp. of ZUBADAN Flash Injection becomes effective.

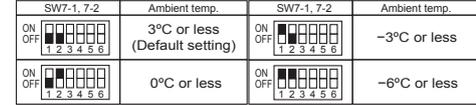

SW7-3 to 6 : Function Switch

The black square (■) indicates a switch position.

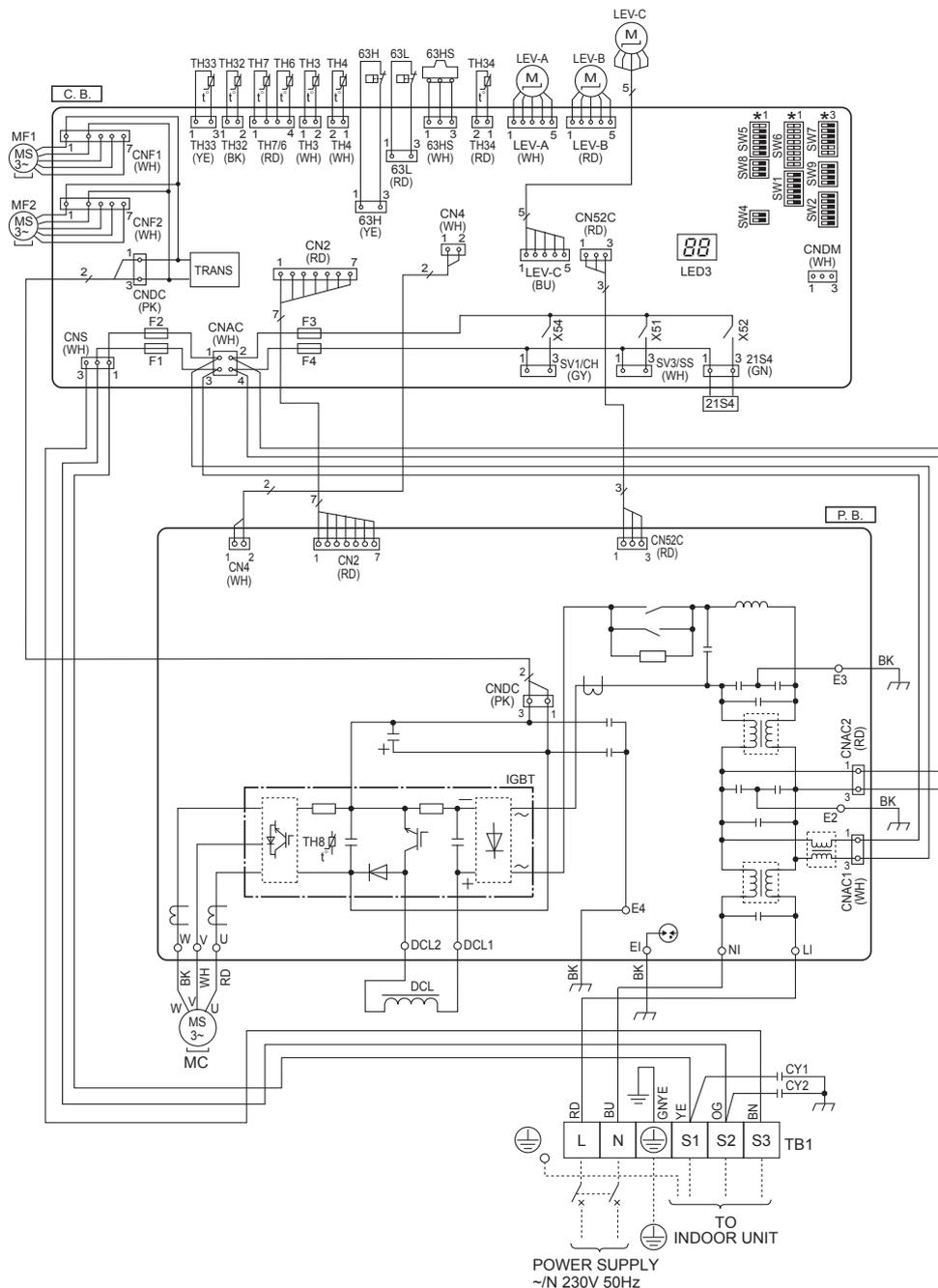

POWER SUPPLY
~N 230V 50Hz

3.2 Split-type units

■ SUHZ-SW45VA

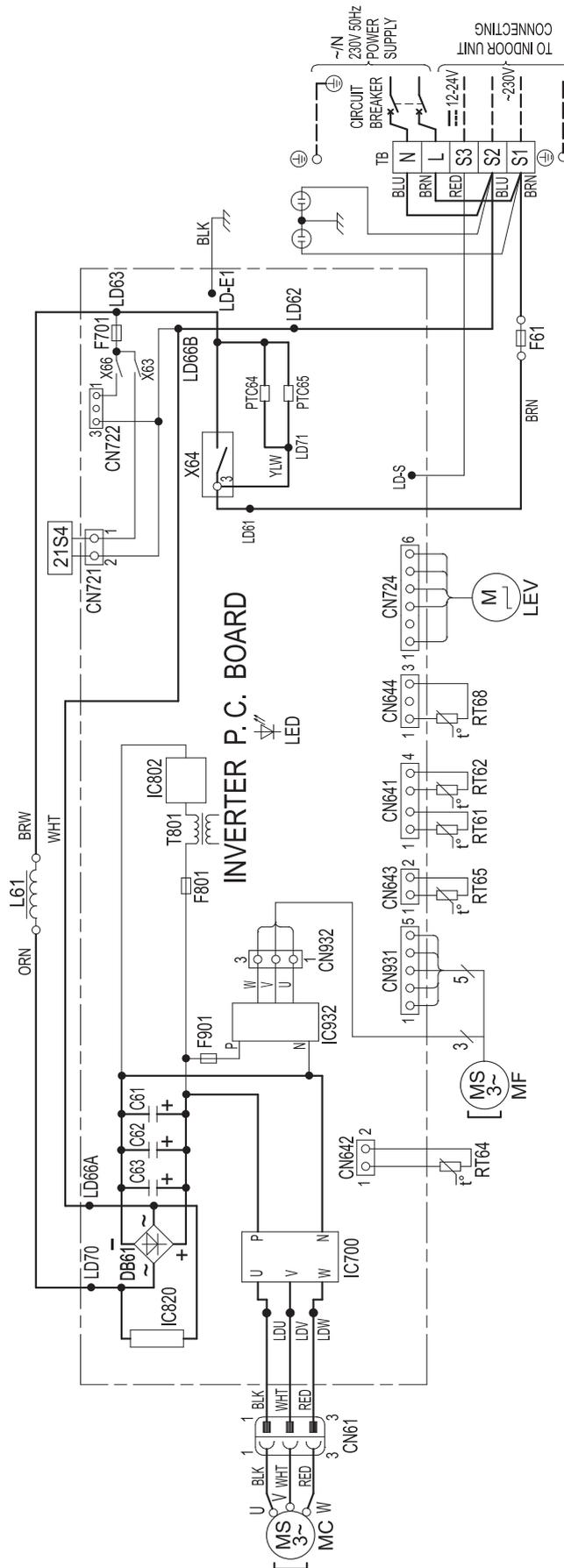

NOTES:
 1. About the indoor side electric wiring refer to the indoor unit electric wiring diagram for servicing.
 2. Use copper conductors only. (For field wiring).

SYMBOL	NAME	SYMBOL	NAME	SYMBOL	NAME
C61, C62, C63	SMOOTHING CAPACITOR	L61	REACTOR	RT68	OUTDOOR HEAT EXCHANGER TEMP. THERMISTOR
DB61	DIODE MODULE	MC	COMPRESSOR	TB	TERMINAL BLOCK
F61	FUSE (T20AL250V)	MF	FAN MOTOR	T801	TRANSFORMER
F701, F801, F901	FUSE (T3, 15A/250V)	PTC64, PTC65	CIRCUIT PROTECTION	X63, X64	RELAY
IC700, IC820, IC932	POWER MODULE	RT61	DEFROST THERMISTOR	X66	REVERSING VALVE COIL
IC802	POWER DEVICE	RT62	DISCHARGE TEMP. THERMISTOR	21S4	REVERSING VALVE COIL
LED	LED	RT64	FIN TEMP. THERMISTOR		
LEV	EXPANSION VALVE COIL	RT65	AMBIENT TEMP. THERMISTOR		

■ SUHZ-SW45VAH

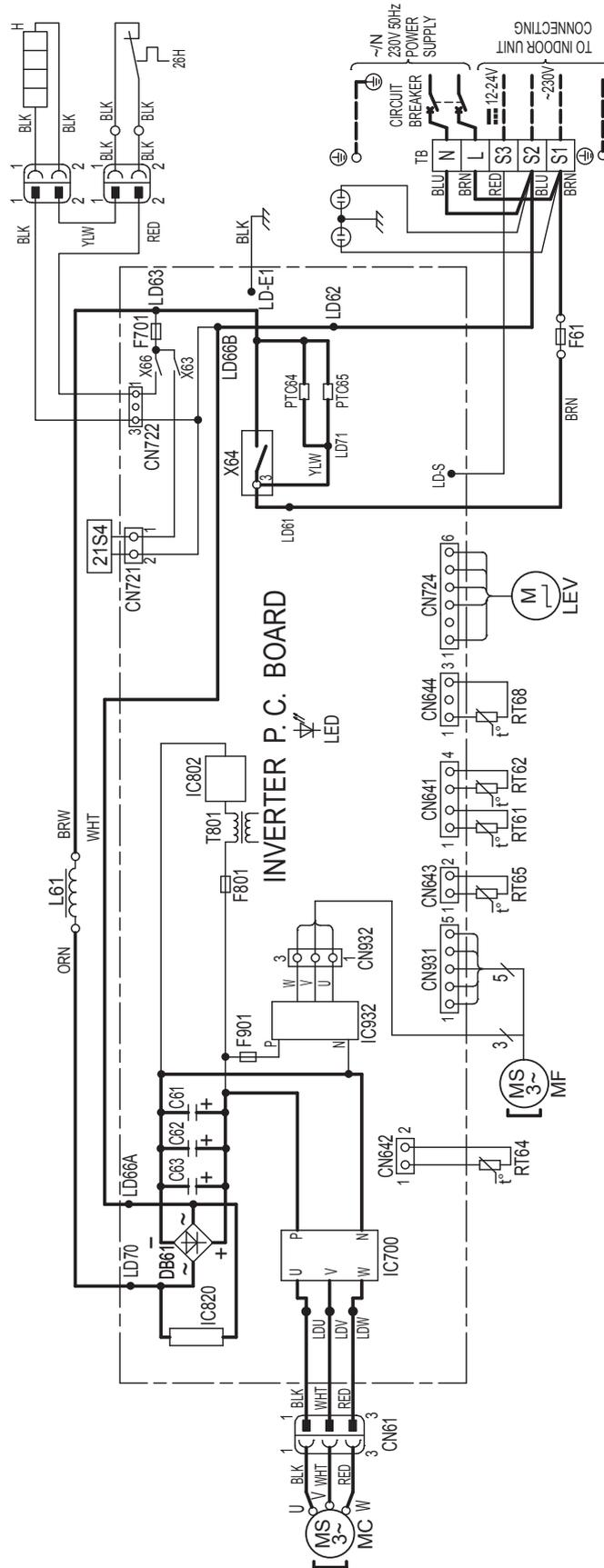

SYMBOL	NAME	SYMBOL	NAME	SYMBOL	NAME
C61, C62, C63	SMOOTHING CAPACITOR	RT65	AMBIENT TEMP. THERMISTOR	LEV	OUTDOOR HEAT EXCHANGER
DB611	DIODE MODULE	L61	EXPANSION VALVE COIL REACTOR	RT68	TEMP. THERMISTOR
F61	FUSE (T20AL250V)	MC	COMPRESSOR	TB	TERMINAL BLOCK
F701, F811, F901	FUSE (T3-15A1.250V)	MF	FAN MOTOR	T801	TRANSFORMER
H	DEFOST HEATER	PT66	CIRCUIT PROTECTION	X63, X64, X66	REVERSING VALVE COIL RELAY
IC820, IC832	POWER MODULE	RT61	DISCHARGE TEMP. THERMISTOR	21S4	HEATER PROTECTOR
LED	LED	RT64	FIN TEMP. THERMISTOR	26H	

■ PUAZ-SW50VKA(-BS)

SYMBOL	NAME	SYMBOL	NAME
TB1	Terminal Block<Power Supply, Indoor/Outdoor>	C. B.	Controller Circuit Board
MC	Motor for Compressor	F1, F2	Fuse<T10AL250V>
MF1	Fan Motor	F3, F4	Fuse<T3.15AL250V>
21S4	Solenoid Valve (4-Way Valve)	CNDM	Connector<Connection for Option>
63H	High Pressure Switch	CN51	Connector<Connection for Option>
63HS	High Pressure Sensor	S. B.	Switch Board
TH3	Thermistor<Liquid>	SW1	Switch<Manual Defrost, Defect History Record Reset, Refrigerant Address>
TH4	Thermistor<Discharge>	SW4	Switch<Function Switch>
TH6	Thermistor<2-Phase Pipe>	SW5	Switch<Function Switch, Model Select>
TH7	Thermistor<Ambient>	SW6	Switch<Model Select>
TH8	Thermistor<Heat Sink>	SW7	Switch<Function Switch>
TH34	Thermistor<Comp. Surface>	SW8	Switch<Function Switch>
LEV-A, LEV-B	Linear Expansion Valve	SWP	Switch<Pump Down>
ACL	Reactor	CNM	Connector<Connection for Option>

*1 MODEL SELECT
The black square (■) indicates a switch position.

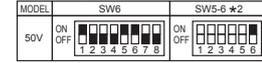

*2 SW5 -1 to 5 : Function Switch

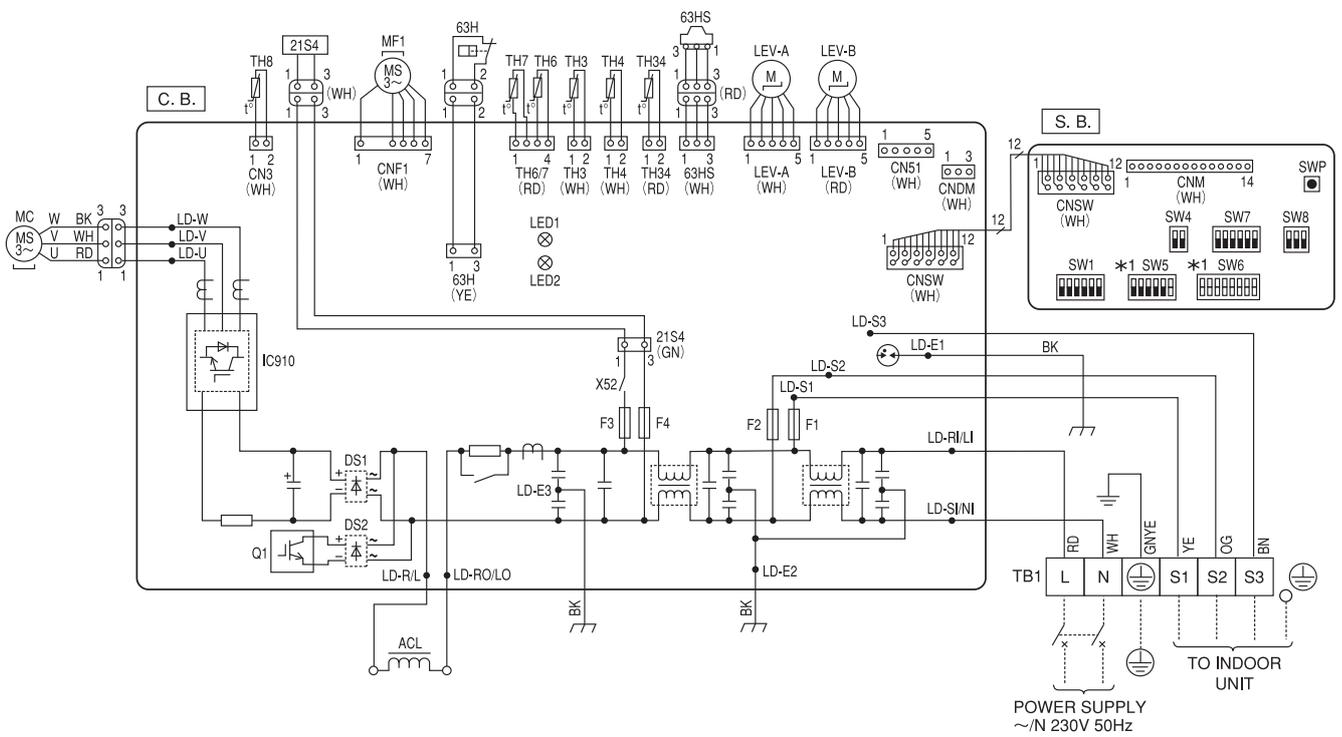

PUHZ-SW75VHA(-BS)

SYMBOL	NAME	SYMBOL	NAME
TB1	Terminal Block <Power Supply, Indoor/Outdoor>	C.B.	Controller Circuit Board
MC	Motor for Compressor	F1, F2, F3, F4	Fuse <T6.3AL250V>
MF1	Fan Motor	SW1	Switch <Manual Defrost, Defect History Record Reset, Refrigerant Address>
21S4	Solenoid Valve (4-Way Valve)	SW4	Switch <Function Switch>
63H	High Pressure Switch	SW5	Switch <Function Switch, Model Select>
63HS	High Pressure Sensor	SW6	Switch <Model Select>
TH3	Thermistor <Liquid>	SW7	Switch <Function Switch>
TH4	Thermistor <Discharge>	SW8	Switch <Function Switch>
TH6	Thermistor <2-Phase Pipe>	SW9	Switch <Function Switch>
TH7	Thermistor <Ambient>	SWP	Switch <Pump Down>
TH8	Thermistor <Heat Sink>	CNDM	Connector <Connection for Option>
TH34	Thermistor <Comp. Surface>	SV1/CH	Connector <Connection for Option>
LEV-A, LEV-B	Linear Expansion Valve	SV3/SS	Connector <Connection for Option>
ACL	Reactor	CNM	Connector <Connection for Option>
CY1, CY2	Capacitor		
P.B.	Power Circuit Board		

*1 MODEL SELECT
The black square (■) indicates a switch position.

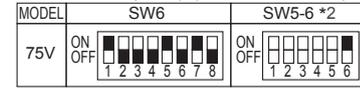

*2 SW5 -1 to 5 : Function Switch

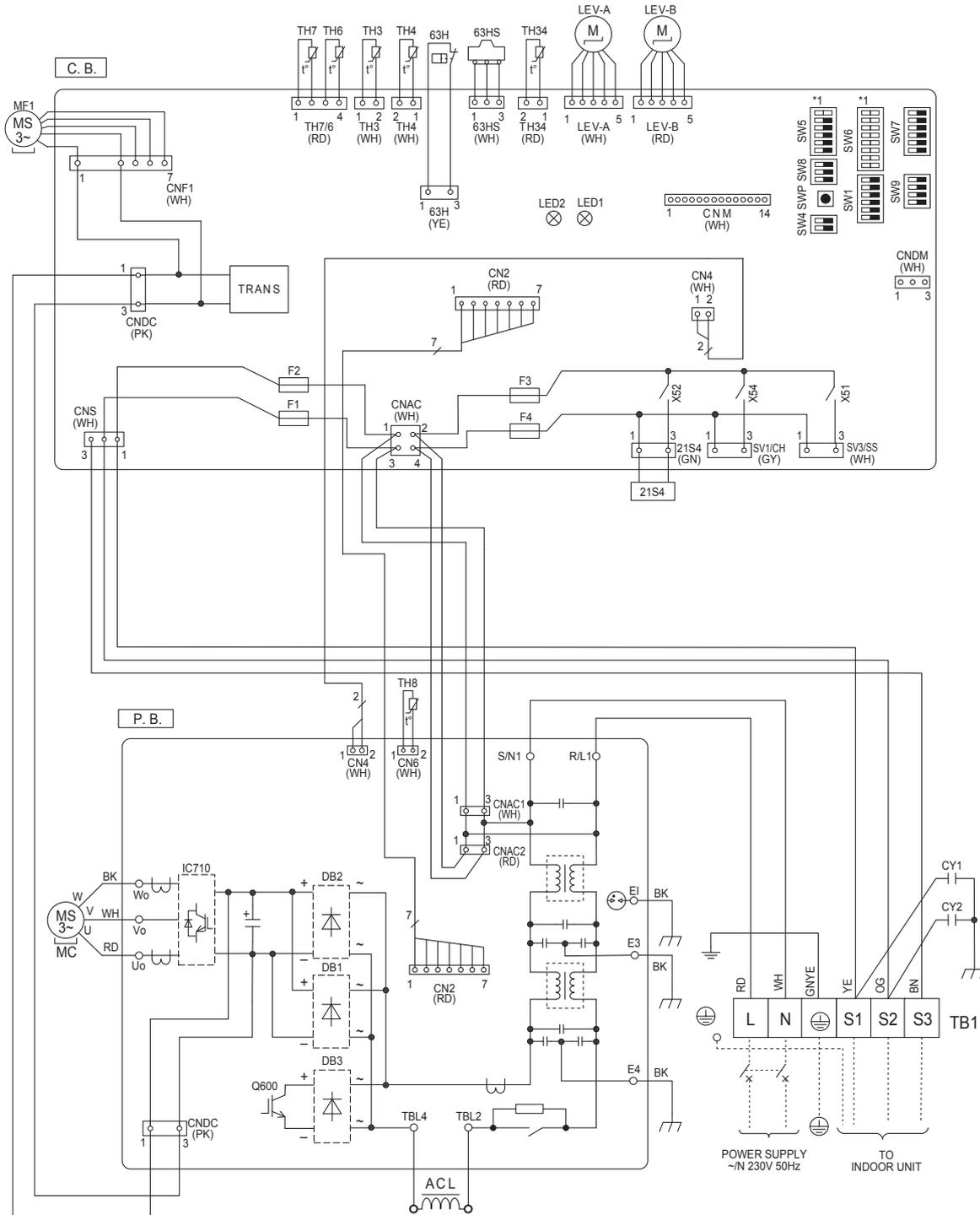

PUHZ-SW100/120VHA(-BS)

SYMBOL	NAME	SYMBOL	NAME	SYMBOL	NAME
TB1	Terminal Block <Power Supply, Indoor/Outdoor>	TH7	Thermistor <Ambient>	SW5	Switch <Function Switch, Model Select>
MC	Motor for Compressor	TH8	Thermistor internal <Heat Sink>	SW6	Switch <Model Select>
MF1, MF2	Fan Motor	TH34	Thermistor <Comp. Surface>	SW7	Switch <Function Switch>
21S4	Solenoid Valve (4-Way Valve)	LEV-A, LEV-B	Linear Expansion Valve	SW8	Switch <Function Switch>
63H	High Pressure Switch	DCL	Reactor	SW9	Switch <Function Switch>
63L	Low Pressure Switch	CY1, CY2	Capacitor	SWP	Switch <Pump Down>
63HS	High Pressure Sensor	P. B.	Power Circuit Board	CNDM	Connector <Connection for Option>
TH3	Thermistor <Liquid>	C. B.	Controller Circuit Board	SV1/CH	Connector <Connection for Option>
TH4	Thermistor <Discharge>	SW1	Switch <Manual Defrost, Defect History Record Reset, Refrigerant Address>	SV3/SS	Connector <Connection for Option>
TH6	Thermistor <2-Phase Pipe>	SW4	Switch <Function Switch>	CNM	Connector <Connection for Option>
				F1, F2, F3, F4	Fuse <T6.3AL250V>

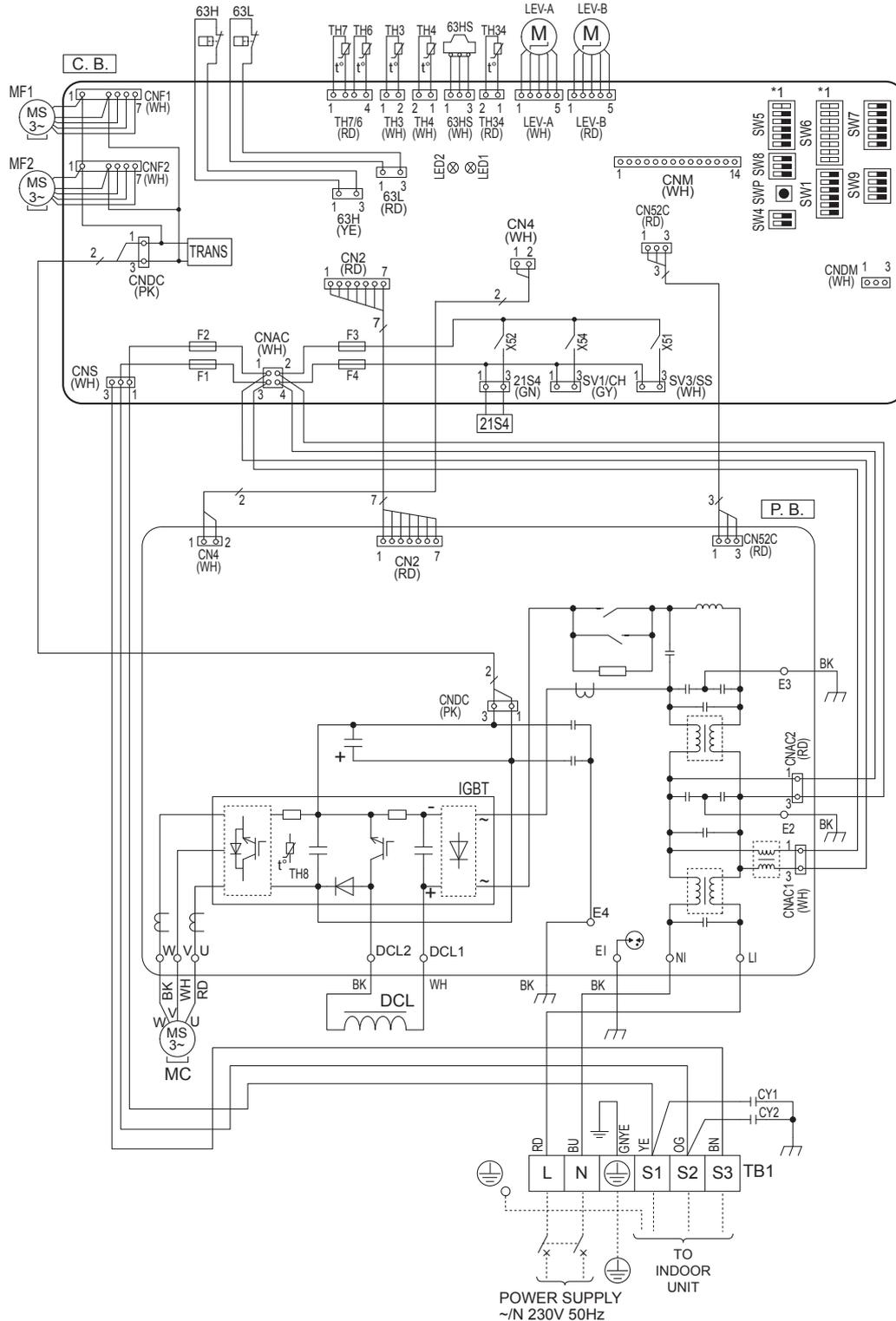
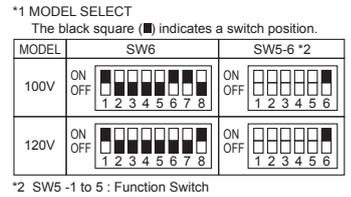

Outdoor unit

■ PUAZ-SW100/120YHA(-BS)

Outdoor unit

SYMBOL	NAME	SYMBOL	NAME	SYMBOL	NAME
TB1	Terminal Block <Power Supply>	TH34	Thermistor <Comp. Surface>	SW4	Switch <Function Switch>
TB2	Terminal Block <Indoor/Outdoor>	LEV-A, LEV-B	Linear Expansion Valve	SW5	Switch <Function Switch, Model Select>
MC	Motor for Compressor	ACL1, ACL2	Reactor	SW6	Switch <Model Select>
MF1, MF2	Fan Motor	ACL3, ACL4	Reactor	SW7	Switch <Function Switch>
21S4	Solenoid Valve (4-Way Valve)	CY1, CY2	Capacitor	SW8	Switch <Function Switch>
63H	High Pressure Switch	CK	Capacitor	SW9	Switch <Function Switch>
63L	Low Pressure Switch	RS	Rush Current Protect Resistor	SWP	Switch <Pump Down>
63HS	High Pressure Sensor	P. B.	Power Circuit Board	CNDM	Connector <Connection for Option>
TH3	Thermistor <Liquid>	N. F.	Noise Filter Circuit Board	SV1/CH	Connector <Connection for Option>
TH4	Thermistor <Discharge>	C. CONV. B.	Converter Circuit Board	SV3/SS	Connector <Connection for Option>
TH6	Thermistor <2-Phase Pipe>	C. B.	Controller Circuit Board	CNM	Connector <Connection for Option>
TH7	Thermistor <Ambient>			F1, F2, F3, F4	Fuse <T6.3AL250V>
TH8	Thermistor <Heat Sink>	SW1	Switch <Manual Defrost, Defect History Record Reset, Refrigerant Address>		

*1 MODEL SELECT
The black square (■) indicates a switch position.

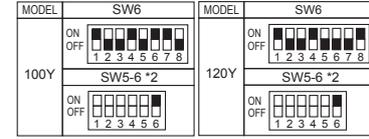

*2 SW5 -1 to 5 : Function Switch

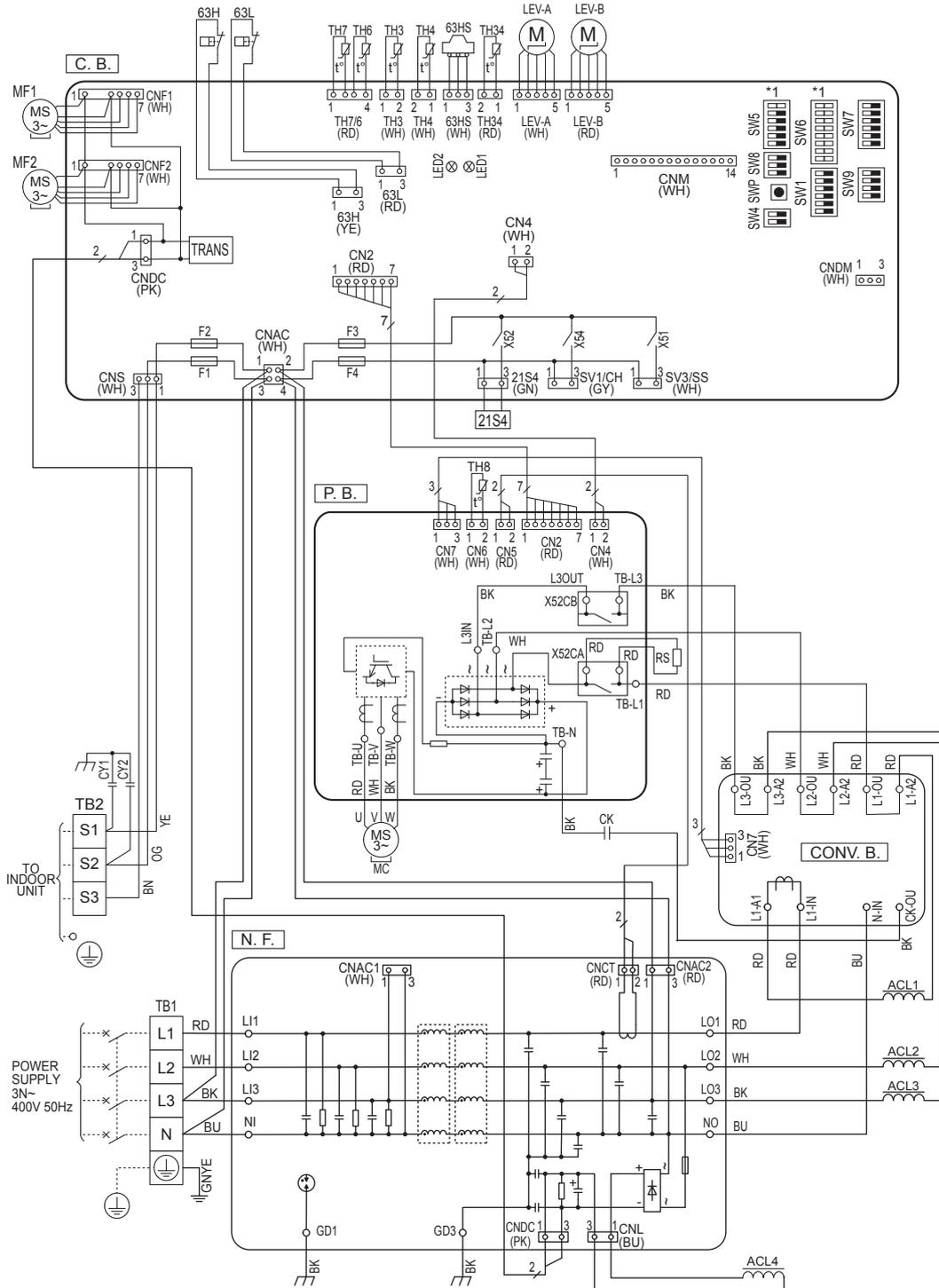

PUHZ-SW160/200YKA(-BS)

Outdoor unit

SYMBOL	NAME	SYMBOL	NAME	SYMBOL	NAME
TB1	Terminal Block <Power Supply>	CY1, CY2	Capacitor	SW8	Switch <Function Switch>
TB2	Terminal Block <Indoor/Outdoor>	P.B.	Power Circuit Board	SW9	Switch <Function Switch>
MC	Motor for Compressor	TB-U/V/W	Connection Terminal <U/V/W-Phase>	SWP	Switch <Pump Down>
MF1, MF2	Fan Motor	TB-L1/L2/L3	Connection Terminal <L1/L2/L3-Power Supply>	CN31	Connector <Emergency Operation>
21S4	Solenoid Valve (Four-Way Valve)	TB-P1/P3	Connection Terminal	CN3S	Connector <Connection for Option>
63H	High Pressure Switch	X52CA/B	52C Relay	CNDM	Connector <Connection for Option>
63HS	High Pressure Sensor	N.F.	Noise Filter Circuit Board	CN51	Connector <Connection for Option>
TH3	Thermistor <Liquid>	L11/L12/L13/N1	Connection Terminal <L1/L2/L3/N-Power Supply>	SV1	Connector <Connection for Option>
TH6	Thermistor <2-Phase Pipe>	LO1/LO2/LO3	Connection Terminal <L1/L2/L3-Power Supply>	SS	Connector <Connection for Option>
TH7	Thermistor <Ambient>	GD1, GD2	Connection Terminal <Ground>	CNM	Connector <Connection for Option>
TH8	Thermistor <Heat Sink>	C.B.	Controller Circuit Board	LED1, LED2	LED <Operation Inspection Indicators>
TH32	Thermistor <Comp. Surface>	SW1	Switch <Manual Defrost, Defect History, Record Reset, Refrigerant Address>	F3, F4	Fuse <T6.3AL250V>
LEV-A	Linear Expansion Valve	SW4	Switch <Test Operation>	X51, X52, X54	Relay
ACL4	Reactor	SW5	Switch <Function Switch, Model Select>		
DCL	Reactor	SW6	Switch <Model Select>		
RS	Rush Current Protect Resistor	SW7	Switch <Function Switch>		
FUSE1, FUSE2	Fuse <T15AL250V>				

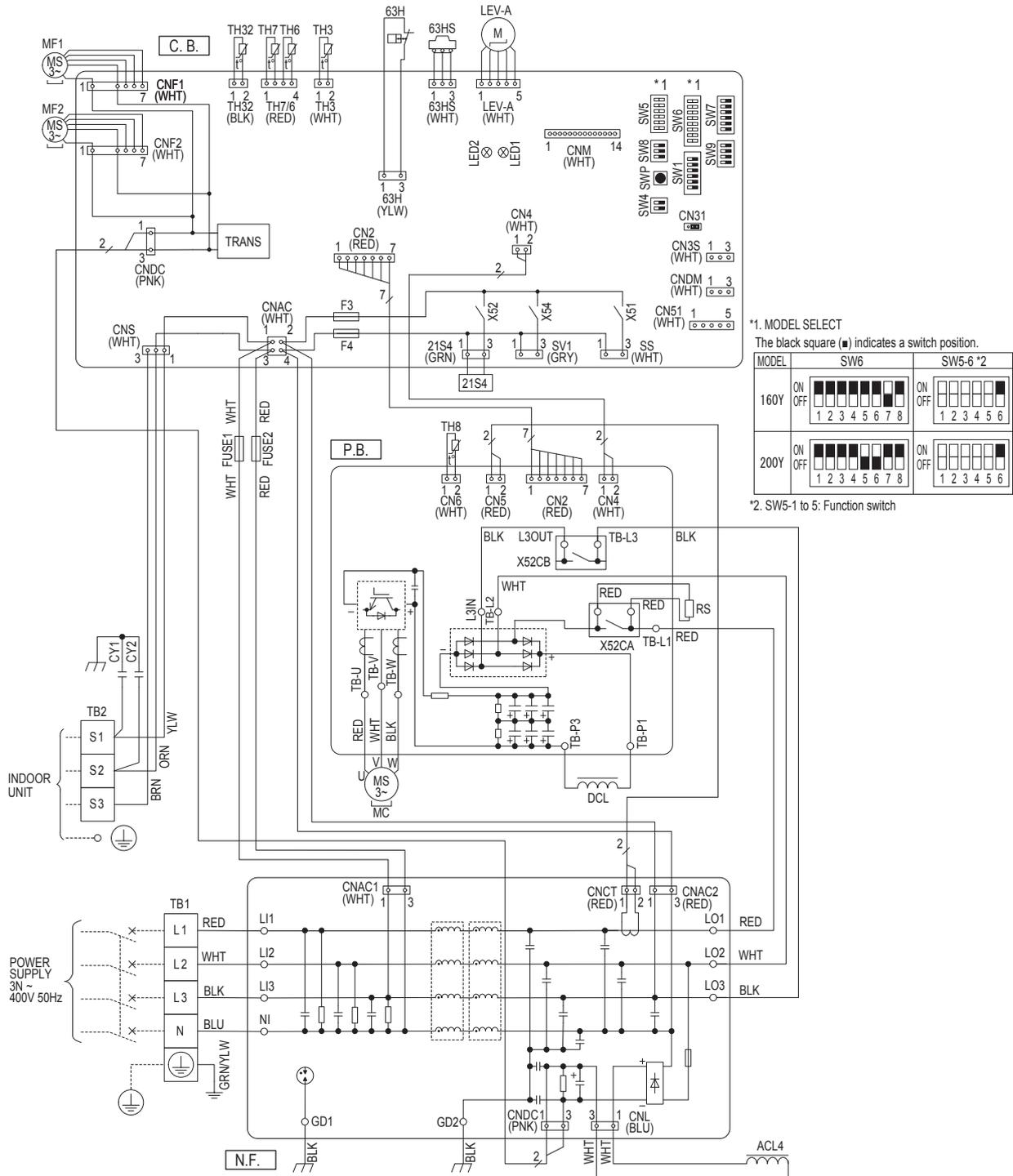

PUHZ-SW75/100VAA(-BS)

Outdoor unit

SYMBOL	NAME	SYMBOL	NAME
TB1	Terminal Block <Power Supply, Indoor/Outdoor>	C.B.	Controller Circuit Board
MC	Motor for Compressor	SW1	Switch <Manual Defrost, Defect History Record Reset, Refrigerant Address>
MF1	Fan Motor	SW4	Switch <Function Switch>
21S4	Solenoid Valve (4-Way Valve)	SW5	Switch <Function Switch>
63H	High Pressure Switch	SW6	Switch <Function Switch, Model Select>
63L	Low Pressure Switch	SW7	Switch <Function Switch>
63HS	High Pressure Sensor	SW8	Switch <Function Switch>
TH3	Thermistor <Liquid>	SW9	Switch <Function Switch>
TH4	Thermistor <Discharge>	SWP	Switch <Pump Down>
TH6	Thermistor <2-Phase Pipe>	CNDM	Connector <Connection for Option>
TH7	Thermistor <Ambient>	SV1/CH	Connector <Connection for Option>
TH8	Thermistor <Heat Sink>	SV3/SS	Connector <Connection for Option>
TH33	Thermistor <Comp. Surface>	CNM	Connector <Connection for Option>
LEV-A, LEV-B	Linear Expansion Valve	F1, F2, F3, F4	Fuse <T6.3AL250V>
DCL1, DCL2, DCL3	Reactor		
CY1, CY2	Capacitor		
P.B.	Power Circuit Board		

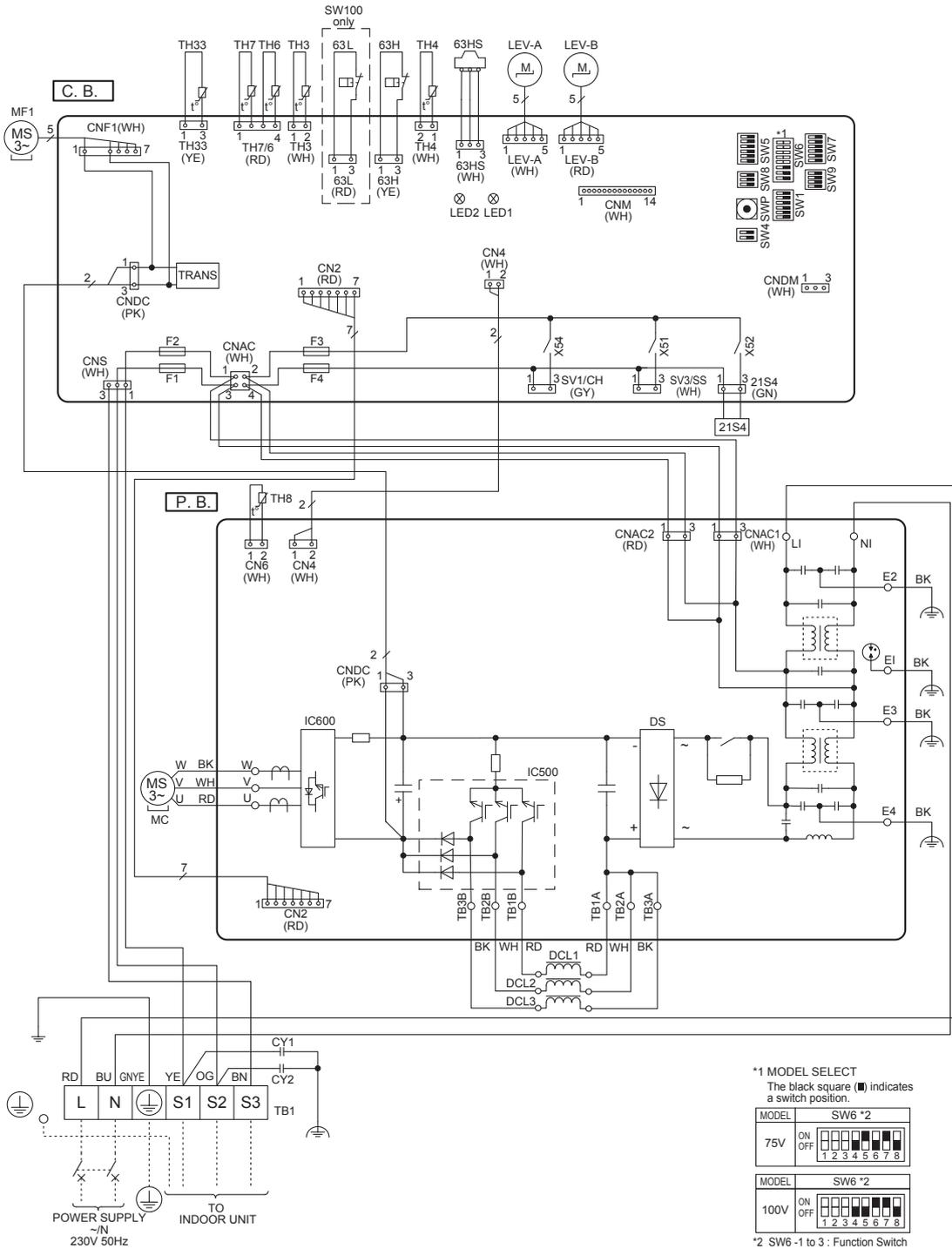

PUHZ-SW75/100YAA(-BS)

Outdoor unit

SYMBOL	NAME	SYMBOL	NAME	SYMBOL	NAME
TB1	Terminal Block <Power Supply>	TH33	Thermistor <Comp. Surface>	SW4	Switch <Function Switch>
TB2	Terminal Block <Indoor/Outdoor>	LEV-A, LEV-B	Linear Expansion Valve	SW5	Switch <Function Switch>
MC	Motor for Compressor	ACL1, ACL2	Reactor	SW6	Switch <Function Switch, Model Select>
MF1	Fan Motor	ACL3, ACL4	Reactor	SW7	Switch <Function Switch>
21S4	Solenoid Valve (4-Way Valve)	CY1, CY2	Capacitor	SW8	Switch <Function Switch>
63H	High Pressure Switch	CK	Capacitor	SW9	Switch <Function Switch>
63L	Low Pressure Switch	RS	Rush Current Protect Resistor	SWP	Switch <Pump Down>
63HS	High Pressure Sensor	P. B.	Power Circuit Board	CNDM	Connector <Connection for Option>
TH3	Thermistor <Liquid>	N. F.	Noise Filter Circuit Board	SV1/CH	Connector <Connection for Option>
TH4	Thermistor <Discharge>	CONV. B.	Converter Circuit Board	SV3/SS	Connector <Connection for Option>
TH6	Thermistor <2-Phase Pipe>	C. B.	Controller Circuit Board	CNM	Connector <Connection for Option>
TH7	Thermistor <Ambient>	SW1	Switch <Manual Defrost, Defect History Record Reset, Refrigerant Address>	F1, F2, F3, F4	Fuse <T6.3AL250V>
TH8	Thermistor <Heat Sink>				

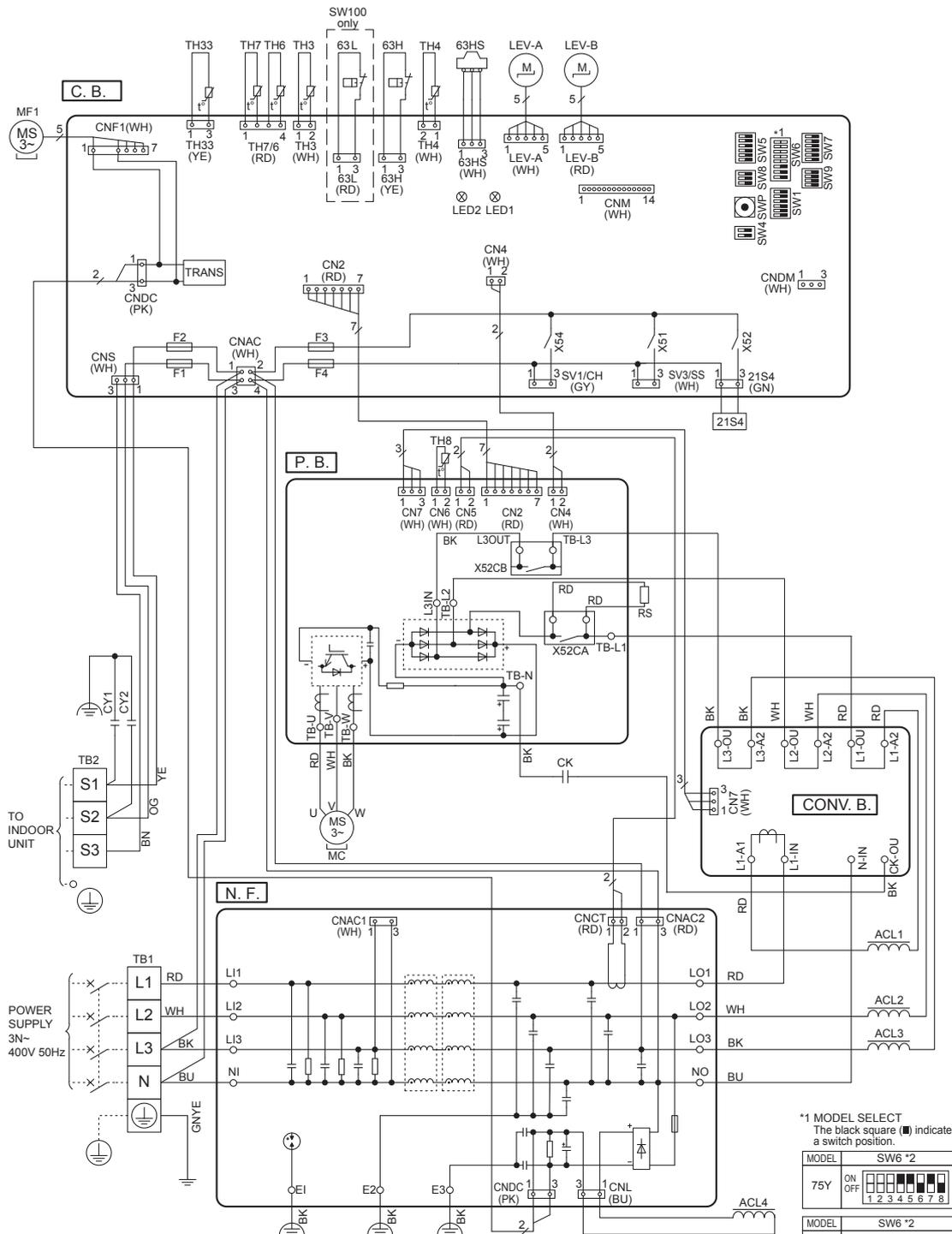

*1 MODEL SELECT
The black square (■) indicates a switch position.

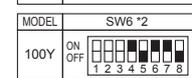
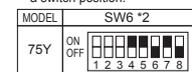

*2 SW6 -1 to 3 : Function Switch

PUHZ-FRP71VHA2

Outdoor unit

SYMBOL	NAME	SYMBOL	NAME	SYMBOL	NAME
TB1	Terminal Block (Power Supply, Indoor/Outdoor)	SV1	Solenoid Valve 1	SW5	Switch (Function Switch, Model Select)
TB2	Terminal Block (Cylinder/Hydrobox UNIT/Outdoor)	SV2	Solenoid Valve 2	SW6	Switch (Model Select)
MC	Motor for Compressor	SV3	Solenoid Valve 3	SW7	Switch (Function Switch, Model Select)
MF1	Fan Motor	LEV-A, LEV-B, LEV-C	Linear Expansion Valve	SW8	Switch (Function Switch)
21S4	Solenoid Valve (4-Way Valve)	DCL	Reactor	SW9	Switch (Function Switch)
63H	High Pressure Switch	CY1, CY2, CY3, CY4	Capacitor	SWP	Switch (Pump Down)
63HS	High Pressure Sensor	P.B.	Power Circuit Board	CNDM	Connector (Connection for Option)
TH3	Thermistor (Liquid)	C.B.	Controller Circuit Board	CN31	Connector (Emergency Operation)
TH4	Thermistor (Discharge)	F1, F2	Fuse (T10AL250V)	CN51	Connector (Connection for Option)
TH6	Thermistor (2-Phase Pipe)	F3, F4	Fuse (T6.3AL250V)	CNM	Connector (Connection for Option)
TH7	Thermistor (Ambient)	SW1	Switch (Manual Defrost, Defect History Record Reset, Refrigerant Address)	LED1, LED2	LED
TH8	Thermistor (Heat Sink)	SW4	Switch (Test Run Switch)		
TH33	Thermistor (Comp. Surface)				

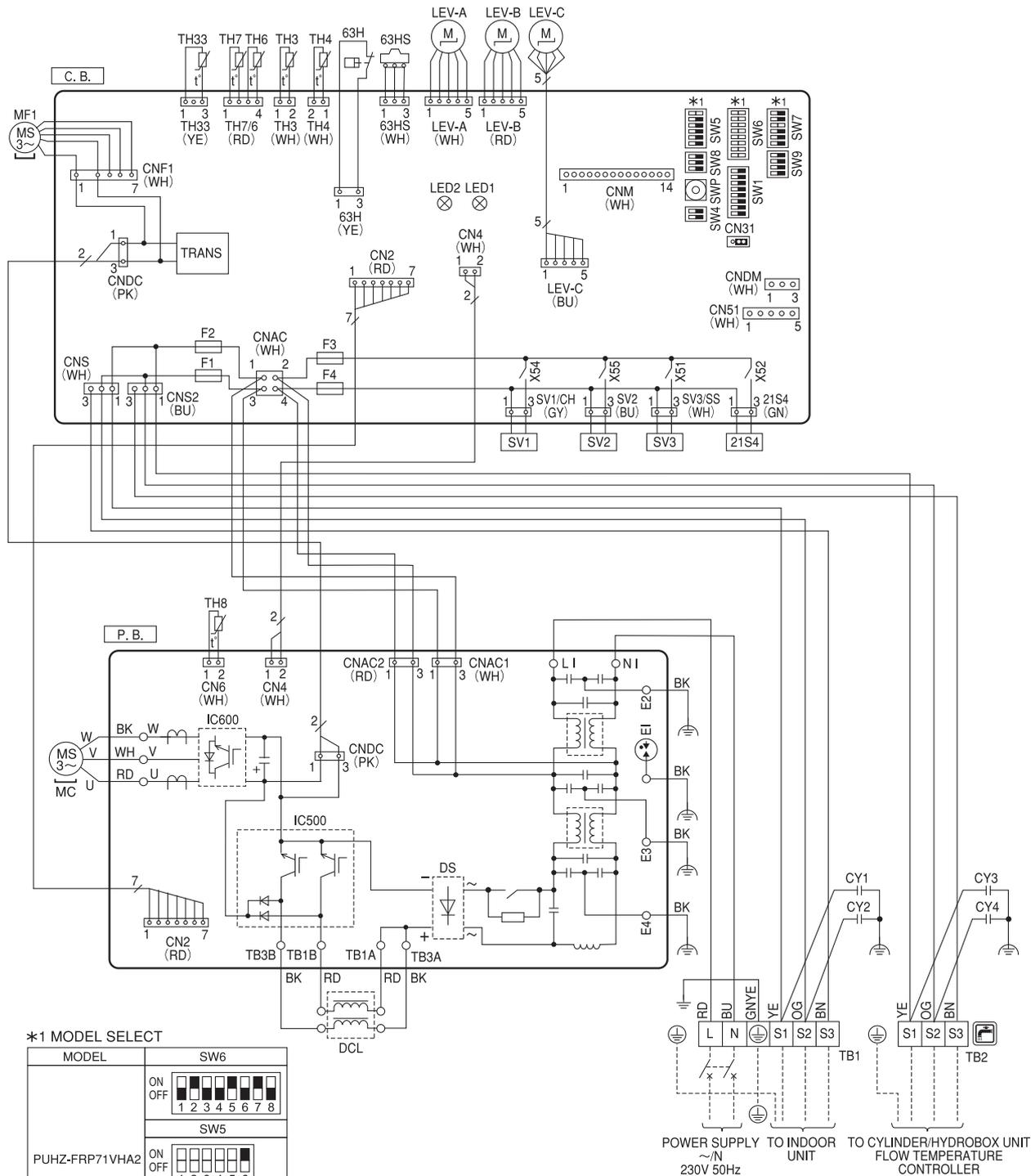

*1 MODEL SELECT

MODEL	SW6
PUHZ-FRP71VHA2	ON OFF
	1 2 3 4 5 6 7 8
	1 2 3 4 5 6
ON OFF	1 2 3 4 5 6
ON OFF	1 2 3 4 5 6

The black square (■) indicates a switch position.

PUHZ-SHW80/112VHA(-BS)

Outdoor unit

SYMBOL	NAME	SYMBOL	NAME	SYMBOL	NAME
TB1	Terminal Block <Power Supply, Indoor/Outdoor>	TH32	Thermistor <Suction>	SW7	Switch <Function Switch>
MC	Motor for Compressor	TH33	Thermistor <Ref. check>	SW8	Switch <Function Switch>
MF1, MF2	Fan Motor	TH34	Thermistor <Comp. Surface>	SW9	Switch <Function Switch>
21S4	Solenoid Valve (4-Way Valve)	LEV-A, LEV-B, LEV-C	Linear Expansion Valve	SWP	Switch <Pump Down>
63H	High Pressure Switch	DCL	Reactor	CN31	Connector <Emergency Operation>
63L	Low Pressure Switch	CY1, CY2	Capacitor	CNDM	Connector <Connection for Option>
63HS	High Pressure Sensor	P. B.	Power Circuit Board	SV1/CH	Connector <Connection for Option>
TH3	Thermistor <Liquid>	C. B.	Controller Circuit Board	SV3/SS	Connector <Connection for Option>
TH4	Thermistor <Discharge>	SW1	Switch <Manual Defrost, Defect History Record Reset, Refrigerant Address>	CNM	Connector <Connection for Option>
TH6	Thermistor <2-Phase Pipe>	SW4	Switch <Test Operation>	F1, F2, F3, F4	Fuse <T6.3AL250V>
TH7	Thermistor <Ambient>	SW5	Switch <Function Switch, Model Select>		
TH8	Thermistor internal <Heat Sink>	SW6	Switch <Model Select>		

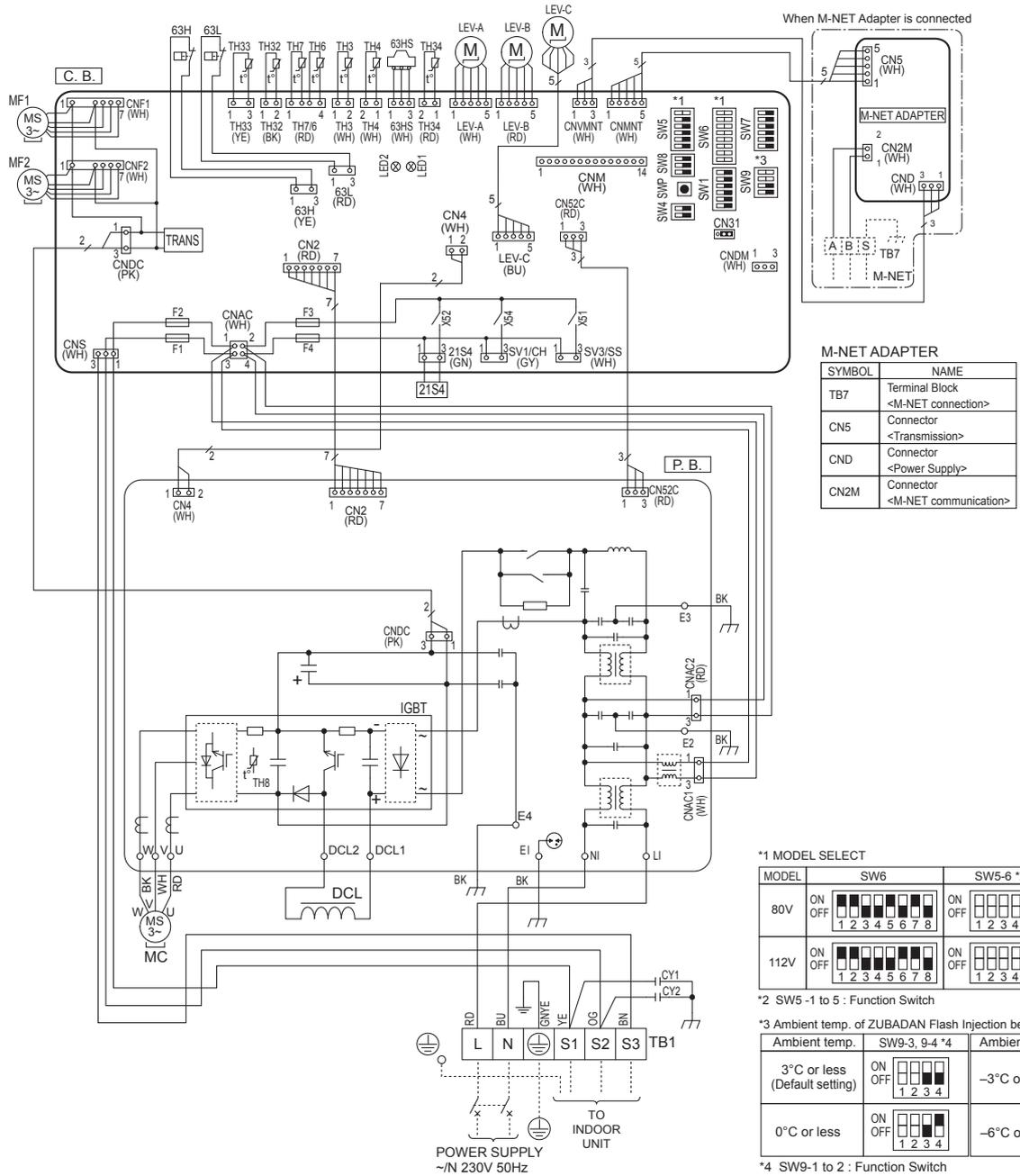

When M-NET Adapter is connected

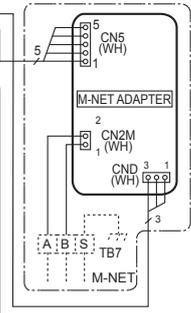

M-NET ADAPTER

SYMBOL	NAME
TB7	Terminal Block <M-NET connection>
CN5	Connector <Transmission>
CN2	Connector <Power Supply>
CN2M	Connector <M-NET communication>

***1 MODEL SELECT**

MODEL	SW6	SW5-6 *2
80V	ON OFF [Switch positions 1-8]	ON OFF [Switch positions 1-6]
112V	ON OFF [Switch positions 1-8]	ON OFF [Switch positions 1-6]

***2 SW5-1 to 5 : Function Switch**

***3 Ambient temp. of ZUBADAN Flash Injection becomes effective.**

Ambient temp.	SW9-3, 9-4 *4	Ambient temp.	SW9-3, 9-4 *4
3°C or less (Default setting)	ON OFF [Switch positions 1-4]	-3°C or less	ON OFF [Switch positions 1-4]
0°C or less	ON OFF [Switch positions 1-4]	-6°C or less	ON OFF [Switch positions 1-4]

*4 SW9-1 to 2 : Function Switch
The black square (■) indicates a switch position.

PUHZ-SHW112/140YHA(-BS)

Outdoor unit

SYMBOL	NAME	SYMBOL	NAME	SYMBOL	NAME
TB1	Terminal Block <Power Supply>	TH33	Thermistor <Ref. check>	SW5	Switch <Function Switch, Model Select>
TB2	Terminal Block <Indoor/Outdoor>	TH34	Thermistor <Comp. Surface>	SW6	Switch <Model Select>
MC	Motor for Compressor	LEV-A, LEV-B, LEV-C	Linear Expansion Valve	SW7	Switch <Function Switch>
MF1, MF2	Fan Motor	ACL1, ACL2, ACL3, ACL4	Reactor	SW8	Switch <Function Switch>
21S4	Solenoid Valve (4-Way Valve)	CY1, CY2	Capacitor	SW9	Switch <Function Switch>
63H	High Pressure Switch	CK	Capacitor	SWP	Switch <Pump Down>
63L	Low Pressure Switch	RS	Rush Current Protect Resistor	CN31	Connector <Emergency Operation>
63HS	High Pressure Sensor	P. B.	Power Circuit Board	CNDM	Connector <Connection for Option>
TH3	Thermistor <Liquid>	N. F.	Noise Filter Circuit Board	SV1/CH	Connector <Connection for Option>
TH4	Thermistor <Discharge>	CONV. B.	Converter Circuit Board	SV3/SS	Connector <Connection for Option>
TH6	Thermistor <2-Phase Pipe>	C. B.	Controller Circuit Board	CNM	Connector <Connection for Option>
TH7	Thermistor <Ambient>	SW1	Switch <Manual Defrost, Defect History Record Reset, Refrigerant Address>	F1, F2, F3, F4	Fuse <T6.3AL250V>
TH8	Thermistor <Heat Sink>	SW4	Switch <Test Operation>		
TH32	Thermistor <Suction>				

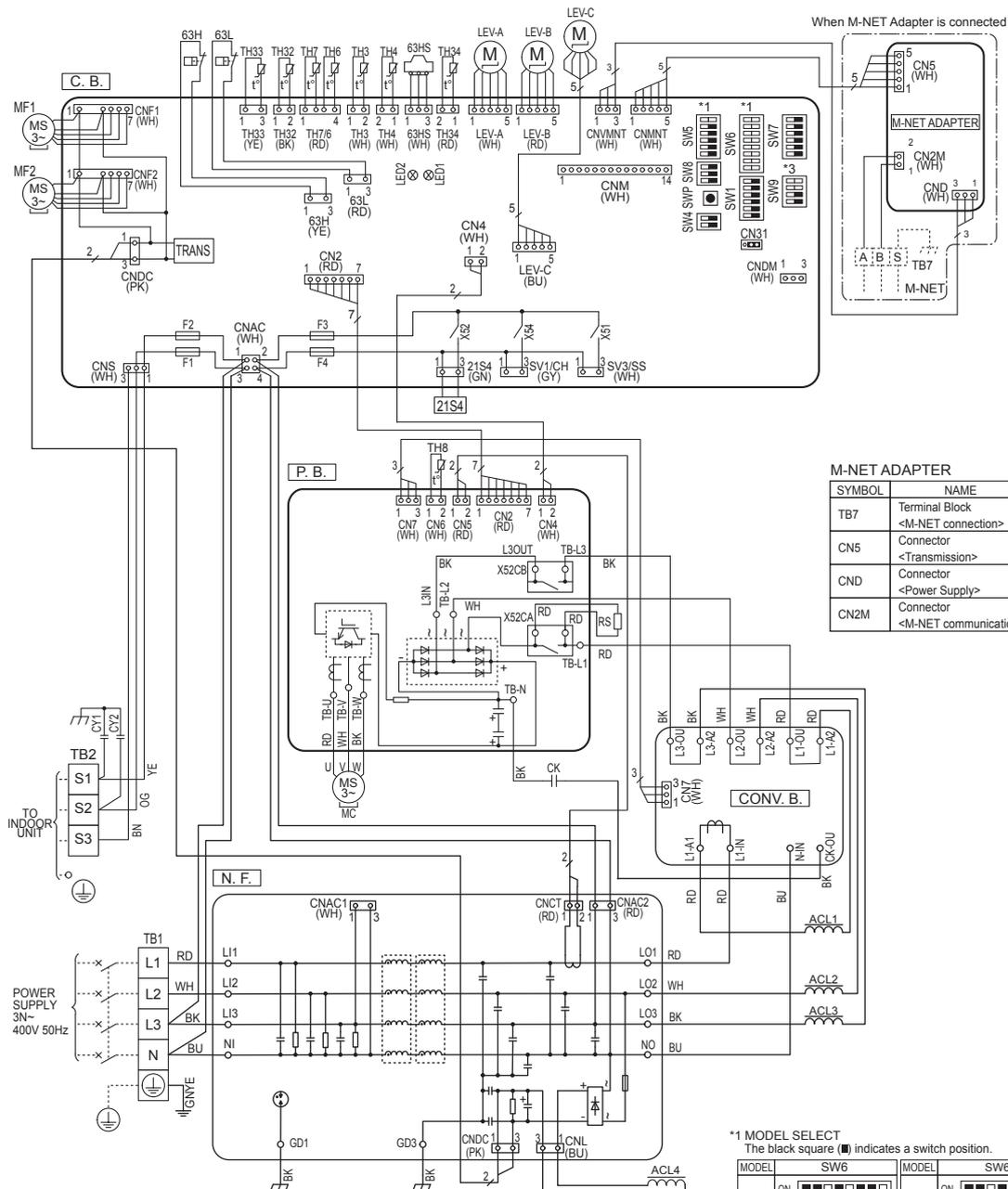

When M-NET Adapter is connected

SYMBOL	NAME
TB7	Terminal Block <M-NET connection>
CN5	Connector <Transmission>
CND	Connector <Power Supply>
CN2M	Connector <M-NET communication>

*3 Ambient temp. of ZUBADAN Flash Injection becomes effective.
The black square (■) indicates a switch position.

Ambient temp.	SW9-3, 9-4 *4	Ambient temp.	SW9-3, 9-4 *4	Ambient temp.	SW9-3, 9-4 *4	Ambient temp.	SW9-3, 9-4 *4
3°C or less (Default setting)	ON OFF ■■■■ 1 2 3 4	0°C or less	ON OFF ■■■■ 1 2 3 4	-3°C or less	ON OFF ■■■■ 1 2 3 4	-6°C or less	ON OFF ■■■■ 1 2 3 4

*4 SW9-1 to 2 : Function Switch

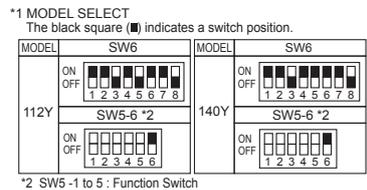

PUHZ-SHW230YKA2

SYMBOL	NAME	SYMBOL	NAME	SYMBOL	NAME
TB1	Terminal Block<Power Supply>	LEV-A, LEV-B, LEV-C	Linear Expansion Valve	SW6	Switch<Model Select>
TB2	Terminal Block<Indoor/Outdoor>	ACL4	Reactor	SW7	Switch<Function Switch>
MC	Motor for Compressor	DCL	Reactor	SW8	Switch<Function Switch>
MF1, MF2	Fan Motor	CB1, CB2	Main Smoothing Capacitor	SW9	Switch<Function Switch>
21S4	Solenoid Valve (4-Way Valve)	RS	Rush Current Protect Resistor	SWP	Switch<Pump Down>
63H	High Pressure Switch	FUSE1, FUSE2	Fuse<T15AL250V>	CN31	Connector<Emergency Operation>
63L	Low Pressure Switch	CY1, CY2	Capacitor	F3, F4	Fuse<T6.3AL250V>
63HS	High Pressure Sensor	P. B.	Power Circuit Board	SV1/CH	Connector<Connection for Option>
TH3	Thermistor<Liquid>	N. F.	Noise Filter Circuit Board	SV3/SS	Connector<Connection for Option>
TH4	Thermistor<Discharge>	C. B.	Controller Circuit Board	CNM	Connector<Connection for Option>
TH6	Thermistor<2-Phase Pipe>	SW1	Switch<Manual Defrost, Defect History Record Reset, Refrigerant Address>	CNMNT	Connector<Connection for Option>
TH7	Thermistor<Ambient>	SW4	Switch<Test Operation>	CNMNT	Connector<Connection for Option>
TH32	Thermistor<Suction>	SW5	Switch<Function Switch, Model Select>	CNDM	Connector<Connection for Option>
TH34	Thermistor<Comp. Surface>				

★1 MODEL SELECT
The black square (■) indicates a switch position.

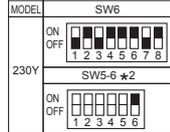

★2 SW5-1 to 5 : Function Switch.

★3 Ambient temp. of ZUBADAN Flash Injection becomes effective.
The black square (■) indicates a switch position.

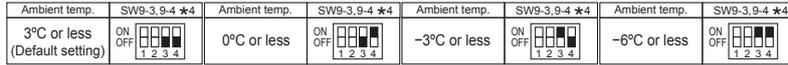

★4 SW9-1 to 2 : Function Switch

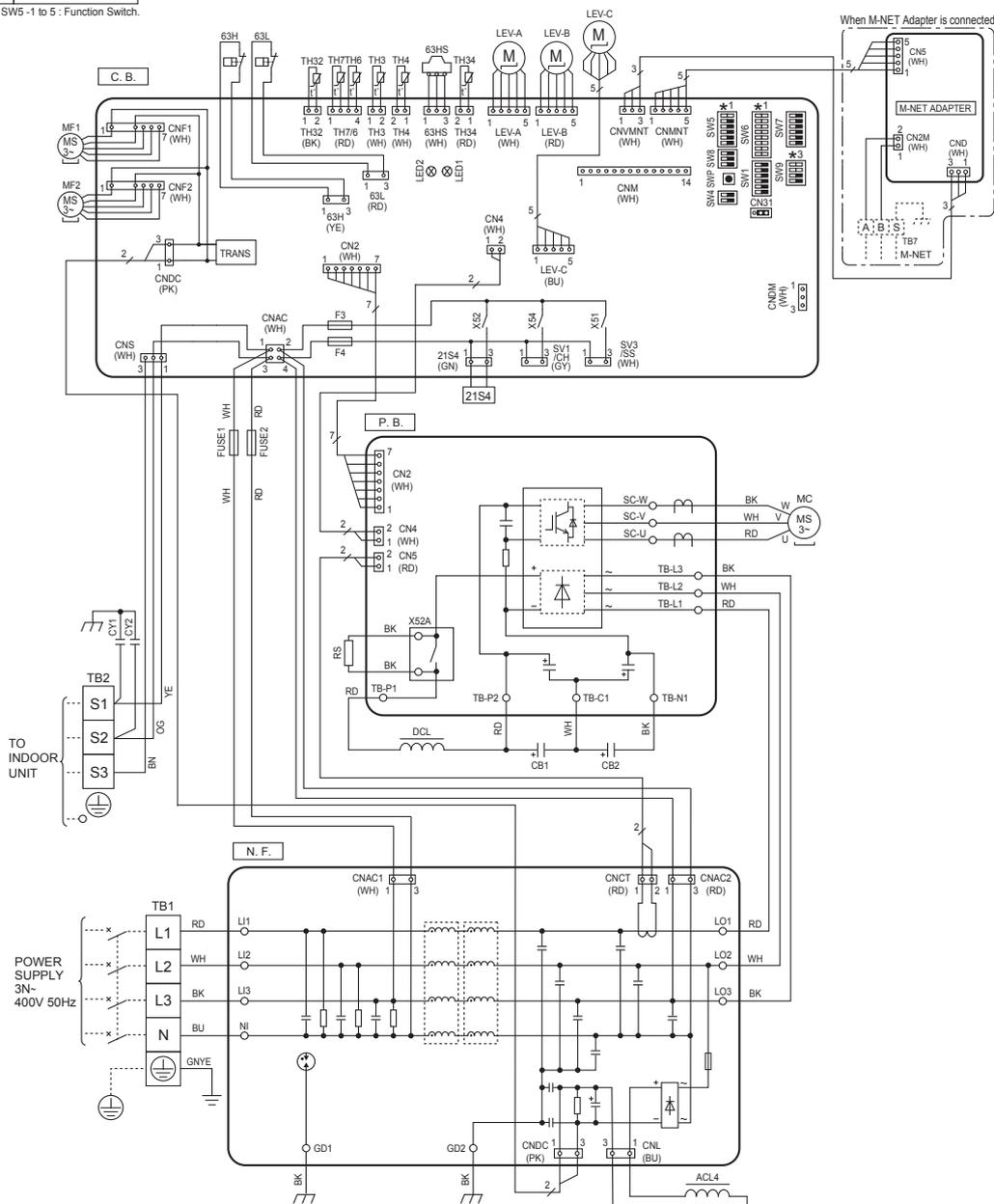

Outdoor unit

■ PUHZ-SHW80/112VAA(-BS)

SYMBOL	NAME	SYMBOL	NAME
TB1	Terminal Block <Power Supply, Indoor/Outdoor>	P.B.	Power Circuit Board
MC	Motor for Compressor	C.B.	Controller Circuit Board
MF1	Fan Motor	SW1	Switch <Manual Defrost, Defect History Record Reset, Refrigerant Address>
21S4	Solenoid Valve (4-Way Valve)	SW4	Switch <Function Switch>
63H	High Pressure Switch	SW5	Switch <Function Switch>
63L	Low Pressure Switch	SW6	Switch <Function Switch, Model Select>
63HS	High Pressure Sensor	SW7	Switch <Function Switch>
TH3	Thermistor <Liquid>	SW8	Switch <Function Switch>
TH4	Thermistor <Discharge>	SW9	Switch <Function Switch>
TH6	Thermistor <2-Phase Pipe>	SWP	Switch <Pump Down>
TH7	Thermistor <Ambient>	CNDM	Connector <Connection for Option>
TH8	Thermistor <Heat Sink>	SV1/CH	Connector <Connection for Option>
TH32	Thermistor <Suction>	SV3/SS	Connector <Connection for Option>
TH33	Thermistor <Comp. Surface>	CNM	Connector <Connection for Option>
LEV-A, LEV-B, LEV-C	Linear Expansion Valve	F1, F2, F3, F4	Fuse <T6.3AL250V>
DCL1, DCL2, DCL3	Reactor		
CY1, CY2	Capacitor		

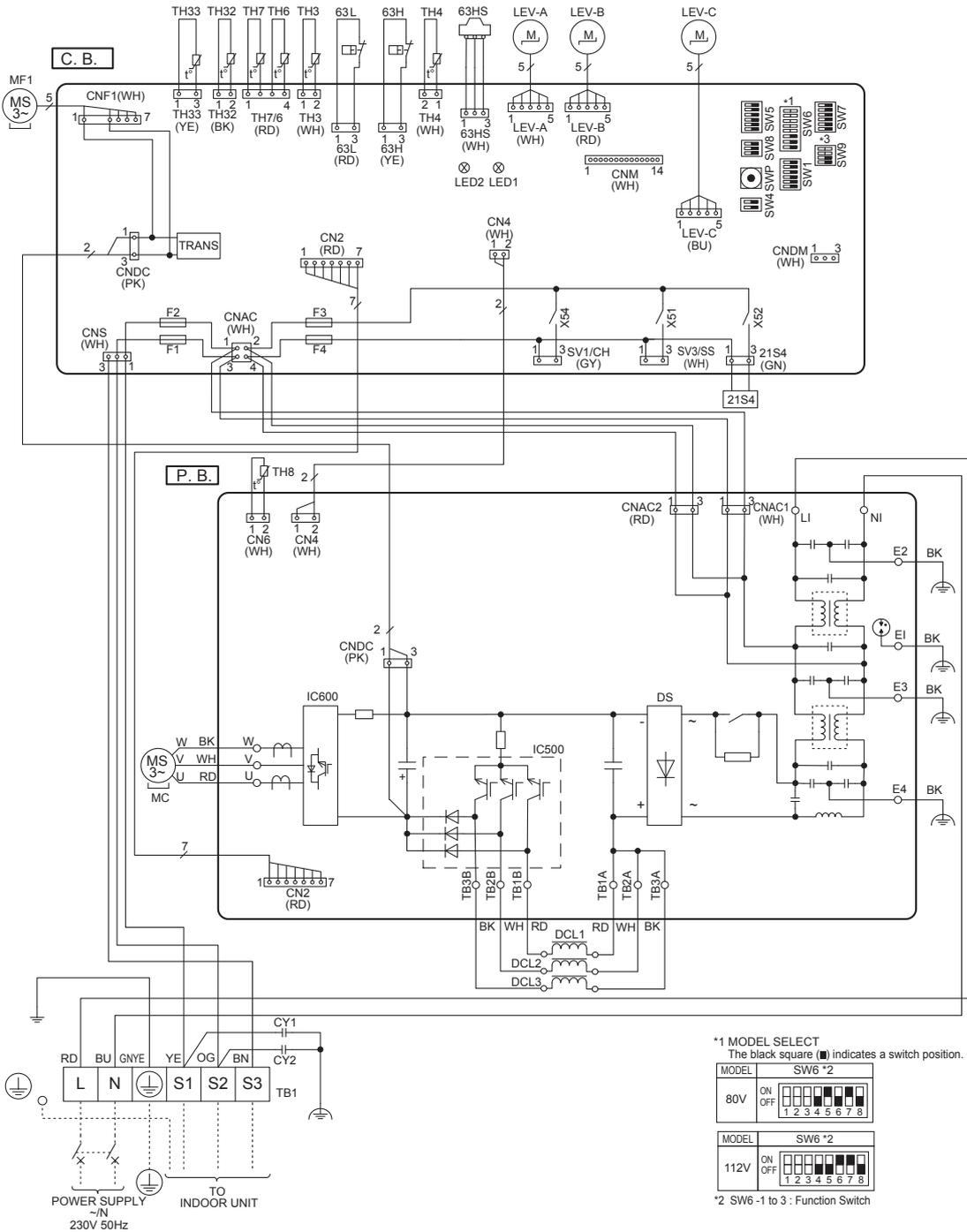

*3 Ambient temp. of ZUBADAN Flash Injection becomes effective. The black square (■) indicates a switch position.

Ambient temp.	SW9-3, 9-4 *4	Ambient temp.	SW9-3, 9-4 *4	Ambient temp.	SW9-3, 9-4 *4	Ambient temp.	SW9-3, 9-4 *4
3°C or less (Default setting)	ON OFF [1 2 3 4]	0°C or less	ON OFF [1 2 3 4]	-3°C or less	ON OFF [1 2 3 4]	-6°C or less	ON OFF [1 2 3 4]

*4 SW9-1 to 2 : Function Switch

PUHZ-SHW80/112YAA(-BS)

Outdoor unit

SYMBOL	NAME	SYMBOL	NAME	SYMBOL	NAME
TB1	Terminal Block <Power Supply>	TH33	Thermistor <Comp. Surface>	SW5	Switch <Function Switch>
TB2	Terminal Block <Indoor/Outdoor>	LV/A, LEV-B, LEV-C	Linear Expansion Valve	SW6	Switch <Function Switch, Model Select>
MC	Motor for Compressor	ACL1, ACL2	Reactor	SW7	Switch <Function Switch>
MF1	Fan Motor	ACL3, ACL4		SW8	Switch <Function Switch>
21S4	Solenoid Valve (4-Way Valve)	CY1, CY2	Capacitor	SW9	Switch <Function Switch>
63H	High Pressure Switch	CK	Capacitor	SWP	Switch <Pump Down>
63L	Low Pressure Switch	RS	Rush Current Protect Resistor	CNDM	Connector <Connection for Option>
63HS	High Pressure Sensor	P. B.	Power Circuit Board	SV1/CH	Connector <Connection for Option>
TH3	Thermistor <Liquid>	N. F.	Noise Filter Circuit Board	SV3/SS	Connector <Connection for Option>
TH4	Thermistor <Discharge>	CONV. B.	Converter Circuit Board	CNM	Connector <Connection for Option>
TH6	Thermistor <2-Phase Pipe>	C. B.	Controller Circuit Board	F1, F2, F3, F4	Fuse <T6.3AL250V>
TH7	Thermistor <Ambient>	SW1	Switch <Manual Defrost, Defect History Record, Reset, Refrigerant Address>		
TH8	Thermistor <Heat Sink>	SW4	Switch <Function Switch>		
TH32	Thermistor <Suction>				

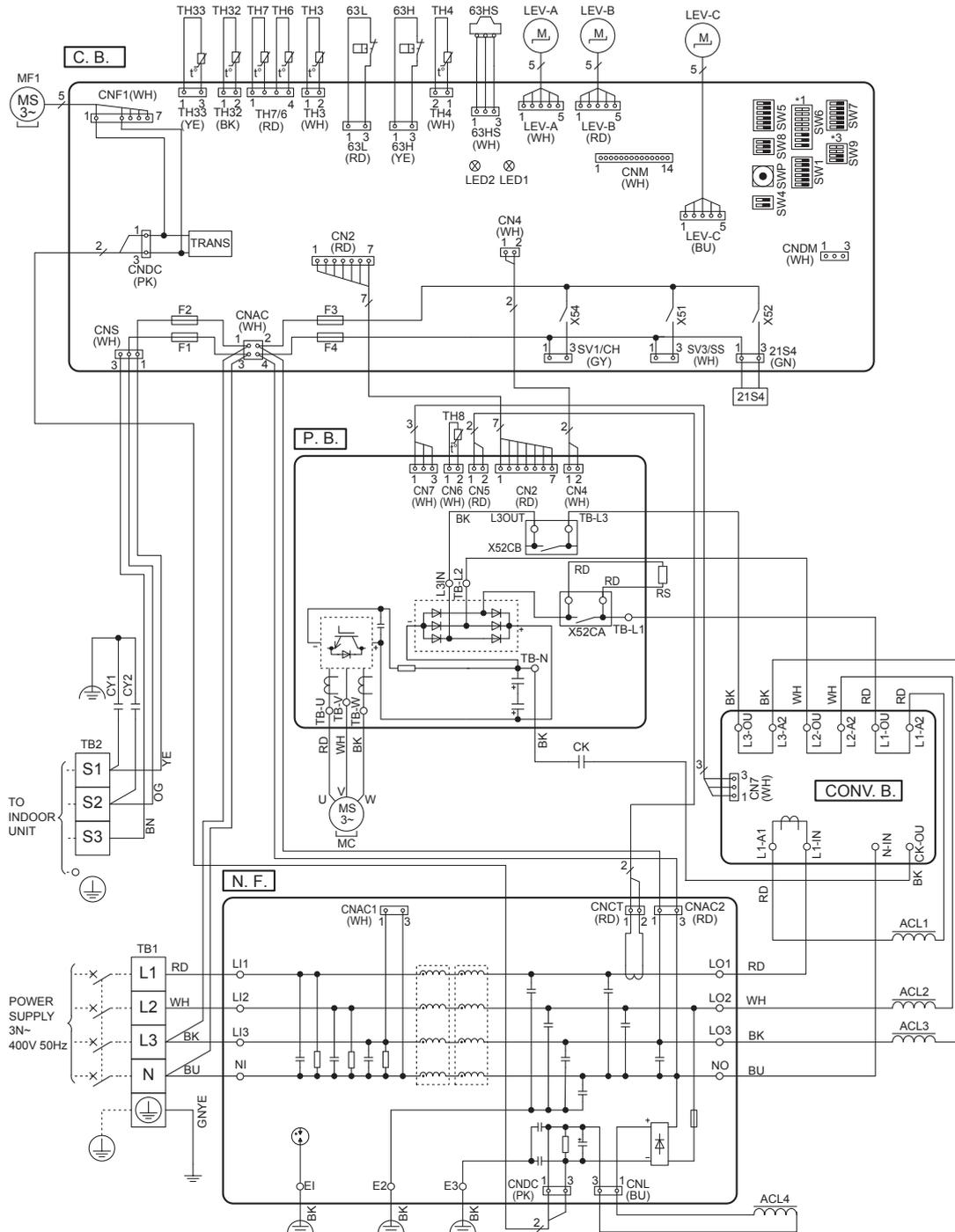

*2 SW6 - 1 to 3 : Function Switch

*3 Ambient temp. of ZUBADAN Flash Injection becomes effective. The black square (■) indicates a switch position.

Ambient temp.	SW9-3, 9-4 *4	Ambient temp.	SW9-3, 9-4 *4	Ambient temp.	SW9-3, 9-4 *4	Ambient temp.	SW9-3, 9-4 *4
3°C or less	ON OFF ■ ■ ■ ■	0°C or less	ON OFF ■ ■ ■ ■	-3°C or less	ON OFF ■ ■ ■ ■	-6°C or less	ON OFF ■ ■ ■ ■
(Default setting)	1 2 3 4		1 2 3 4		1 2 3 4		1 2 3 4

*4 SW9-1 to 2 : Function Switch

*1 MODEL SELECT

The black square (■) indicates a switch position.

MODEL	SW6 *2
80Y	ON OFF ■ ■ ■ ■ ■ ■ ■ ■
	1 2 3 4 5 6 7 8

MODEL	SW6 *2
112Y	ON OFF ■ ■ ■ ■ ■ ■ ■ ■
	1 2 3 4 5 6 7 8

PUMY-P112VKM4 **PUMY-P125VKM4** **PUMY-P140VKM4**
PUMY-P112VKM4-BS **PUMY-P125VKM4-BS** **PUMY-P140VKM4-BS**

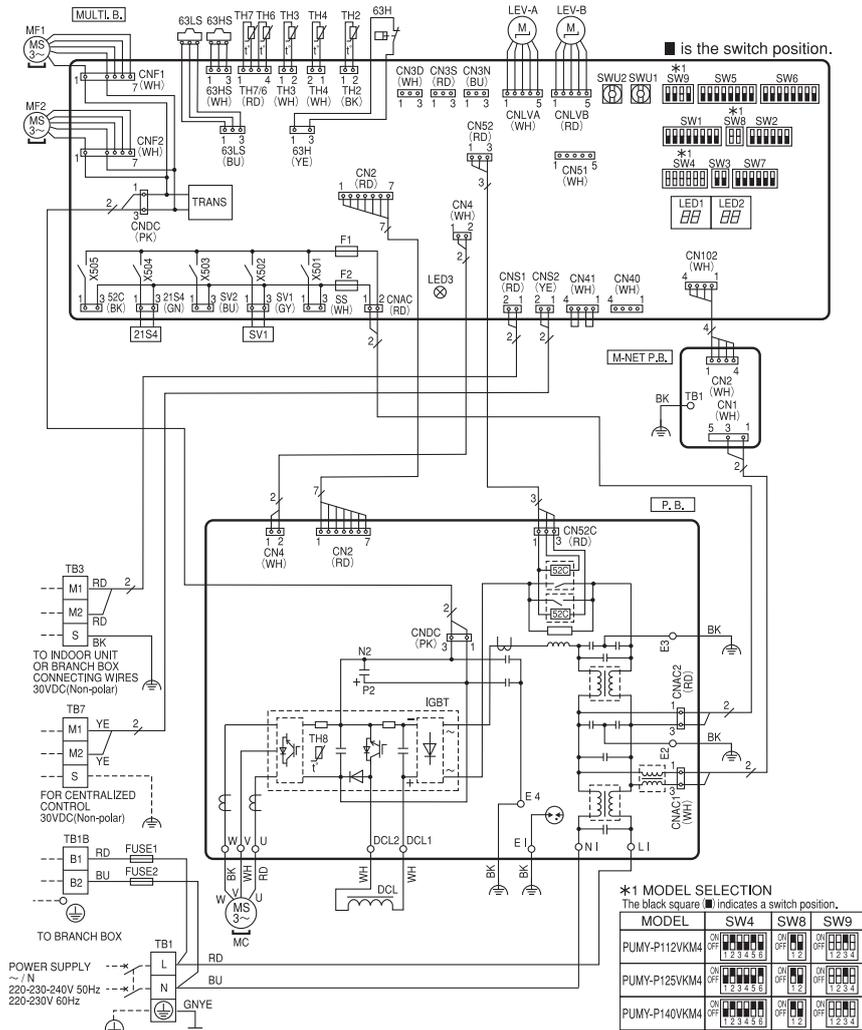

SYMBOL	NAME	SYMBOL	NAME	SYMBOL	NAME
TB1	Terminal Block (Power Supply)	TH8	Thermistor (Heat Sink)	SW9	Switch (Function/Model Selection)
TB1B	Terminal Block (Branch Box)	LEV-A,LEV-B	Linear Expansion Valve	SWU1	Switch (Unit Address Selection, ones digit)
TB3	Terminal Block (Indoor/Outdoor, Branch Box/Outdoor Transmission Line)	DCL	Reactor	SWU2	Switch (Unit Address Selection, tens digit)
TB7	Terminal Block (Centralized Control Transmission Line)	P.B.	Power Circuit Board	CNS1	Connector (Indoor/Outdoor, Branch Box/Outdoor Transmission Line)
FUSE1,FUSE2	Fuse (T20AL250V)	U/V/W	Connection Terminal (U/V/W-Phase)	CNS2	Connector (Centralized Control Transmission Line)
MC	Motor for Compressor	L1	Connection Terminal (L-Phase)	SS	Connector (Connection for Option)
MF1,MF2	Fan Motor	N1	Connection Terminal (N-Phase)	CN3D	Connector (Connection for Option)
21S4	Solenoid Valve Coil (Four-Way Valve)	IGBT	Power Module	CN3S	Connector (Connection for Option)
63H	High Pressure Switch	E1E2,E3,E4	Connection Terminal (Electrical Parts Box)	CN3N	Connector (Connection for Option)
63HS	High Pressure Sensor	MULTLB.	Multi Controller Circuit Board	CNS1	Connector (Connection for Option)
63LS	Low Pressure Sensor	SW1	Switch (Display Selection)	LED1,LED2	LED (Operation Inspection Display)
SV1	Solenoid Valve Coil (Bypass Valve)	SW2	Switch (Function Selection)	LED3	LED (Power Supply to Main Microcomputer)
TH2	Thermistor (Hic Pipe)	SW3	Switch (Test Run)	F1,F2	Fuse (T6.3AL250V)
TH3	Thermistor (Outdoor Liquid Pipe)	SW4	Switch (Model Selection)	X501~505	Relay
TH4	Thermistor (Compressor)	SW5	Switch (Function Selection)	M-NET P.B.	M-NET Power Circuit Board
TH6	Thermistor (Suction Pipe)	SW6	Switch (Function Selection)	TB1	Connection Terminal (Electrical Parts Box)
TH7	Thermistor (Ambient)	SW7	Switch (Function Selection)		
		SW8	Switch (Model Selection)		

Cautions when Servicing

- ⚠ WARNING: When the main supply is turned off, the voltage [340 V] in the main capacitor will drop to 20 V in approx. 2 minutes (input voltage: 230 V). When servicing, make sure that LED1, LED2 on the outdoor multi controller circuit board goes out, and then wait for at least 1 minute.
- Components other than the outdoor circuit boards may be faulty: Check and take corrective action, referring to the service manual. Do not replace the outdoor circuit boards without checking.

NOTES:

- Refer to the wiring diagrams of the indoor units for details on wiring of each indoor unit.
- Self-diagnosis function

The indoor and outdoor units can be diagnosed automatically using the self-diagnosis switch (SW1) and LED indication (LED1, LED2) found on the outdoor multi controller circuit board.

- LED indication : Set all contacts of SW1 to OFF.
- During normal operation
The LED indicates the drive state of outdoor unit.

Bit	1	2	3	4	5	6	7	8
Indication	Compressor operated	52C	21S4	SV1	(SV2)	—	—	Always lit

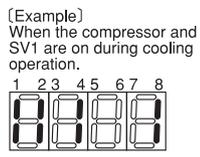

- When fault requiring inspection has occurred
The LED alternately indicates the check code and the address of the unit in which the fault has occurred.

PUMY-P112YKM4 PUMY-P112YKM4-BS

PUMY-P125YKM4 PUMY-P125YKM4-BS

PUMY-P140YKM4 PUMY-P140YKM4-BS

Outdoor unit

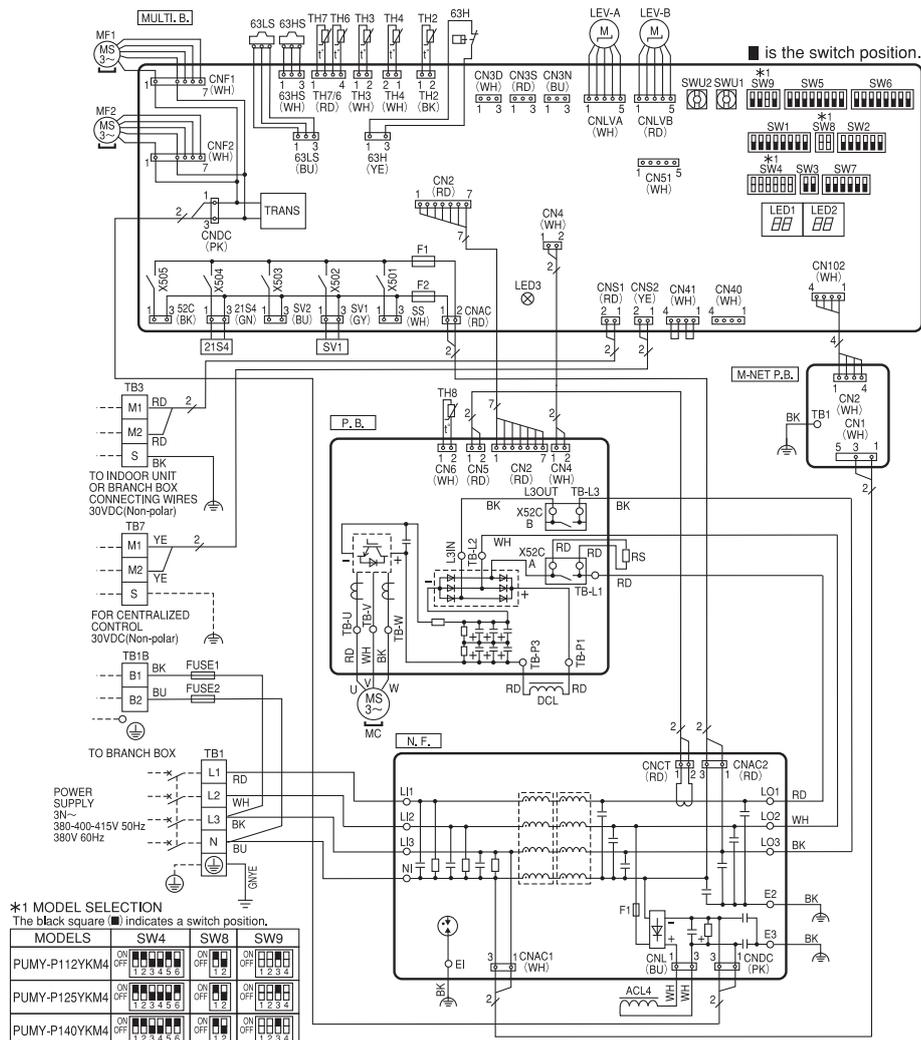

SYMBOL	NAME	SYMBOL	NAME	SYMBOL	NAME
TB1	Terminal Block (Power Supply)	RS	Rush Current Protect Resistor	SW6	Switch (Function Selection)
TB1B	Terminal Block (Branch Box)	LEV-A,LEV-B	Linear Expansion Valve	SW7	Switch (Function Selection)
TB3	Terminal Block (Indoor/Outdoor, Branch Box/Outdoor Transmission Line)	ACL4	Reactor	SW8	Switch (Model Selection)
TB7	Terminal Block (Centralized Control Transmission Line)	DCL	Reactor	SW9	Switch (Function/Model Selection)
FUSE1,FUSE2	Fuse (T20AL250V)	P.B.	Power Circuit Board	SWU1	Switch (Unit Address Selection, ones digit)
MC	Motor for Compressor	TB-U/V/W	Connection Terminal (U/V/W-Phase)	SWU2	Switch (Unit Address Selection, tens digit)
MF1,MF2	Fan Motor	TB-L1,L2,L3	Connection Terminal (L1/L2/L3-Power Supply)	CNS1	Connector (Indoor/Outdoor, Branch Box/Outdoor Transmission Line)
21S4	Solenoid Valve Coil (Four-Way Valve)	TB-P1,P3	Connection Terminal	CNS2	Connector (Centralized Control Transmission Line)
63H	High Pressure Switch	X52CA/B	52C Relay	SS	Connector (Connection for Option)
63HS	High Pressure Sensor	N.F.	Noise Filter Circuit Board	CN3D	Connector (Connection for Option)
63LS	Low Pressure Sensor	L01,L02,L03	Connection Terminal (L1/L2/L3-Power Supply)	CN3S	Connector (Connection for Option)
SV1	Solenoid Valve Coil (Bypass Valve)	L1/L2,L3,N	Connection Terminal (L1/L2/L3,N-Power Supply)	CN3N	Connector (Connection for Option)
TH2	Thermistor (Hic Pipe)	E1,E2,E3	Connection Terminal (Electrical Parts Box)	CN51	Connector (Connection for Option)
TH3	Thermistor (Outdoor Liquid Pipe)	F1	Fuse (T6,3AL250V)	CN102	Connector (Connection for Option)
TH4	Thermistor (Compressor)	MULTI.B.	Multi Controller Circuit Board	LED1,LED2	LED (Operation Inspection Display)
TH6	Thermistor (Suction Pipe)	SW1	Switch (Display Selection)	LED3	LED (Power Supply to Main Microcomputer)
TH7	Thermistor (Ambient)	SW2	Switch (Function Selection)	F1,F2	Fuse (T6,3AL250V)
TH8	Thermistor (Heat Sink)	SW3	Switch (Test Run)	X501~505	Relay
		SW4	Switch (Model Selection)	M-NET P.B.	M-NET Power Circuit Board
		SW5	Switch (Function Selection)	TB1	Connection Terminal (Electrical Parts Box)

Cautions when Servicing

- ⚠ WARNING: When the main supply is turned off, the voltage [570 V] in the main capacitor will drop to 20 V in approx. 5 minutes (input voltage: 400 V). When servicing, make sure that LED1, LED2 on the outdoor multi controller circuit board goes out, and then wait for at least 5 minutes.
- Components other than the outdoor circuit boards may be faulty: Check and take corrective action, referring to the service manual. Do not replace the outdoor circuit boards without checking.

NOTES:

- Refer to the wiring diagrams of the indoor units for details on wiring of each indoor unit.
- Self-diagnosis function
The indoor and outdoor units can be diagnosed automatically using the self-diagnosis switch (SW1) and LED indication (LED1, LED2) found on the outdoor multi controller circuit board.
LED indication : Set all contacts of SW1 to OFF.

- During normal operation
The LED indicates the drive state of outdoor unit.

Bit	1	2	3	4	5	6	7	8
Indication	Compressor operated	52C	21S4	SV1	(SV2)	—	—	Always lit

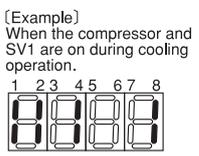

- When fault requiring inspection has occurred
The LED alternately indicates the check code and the address of the unit in which the fault has occurred.

PUMY-P112YKME4
PUMY-P112YKME4-BS

PUMY-P125YKME4
PUMY-P125YKME4-BS

PUMY-P140YKME4
PUMY-P140YKME4-BS

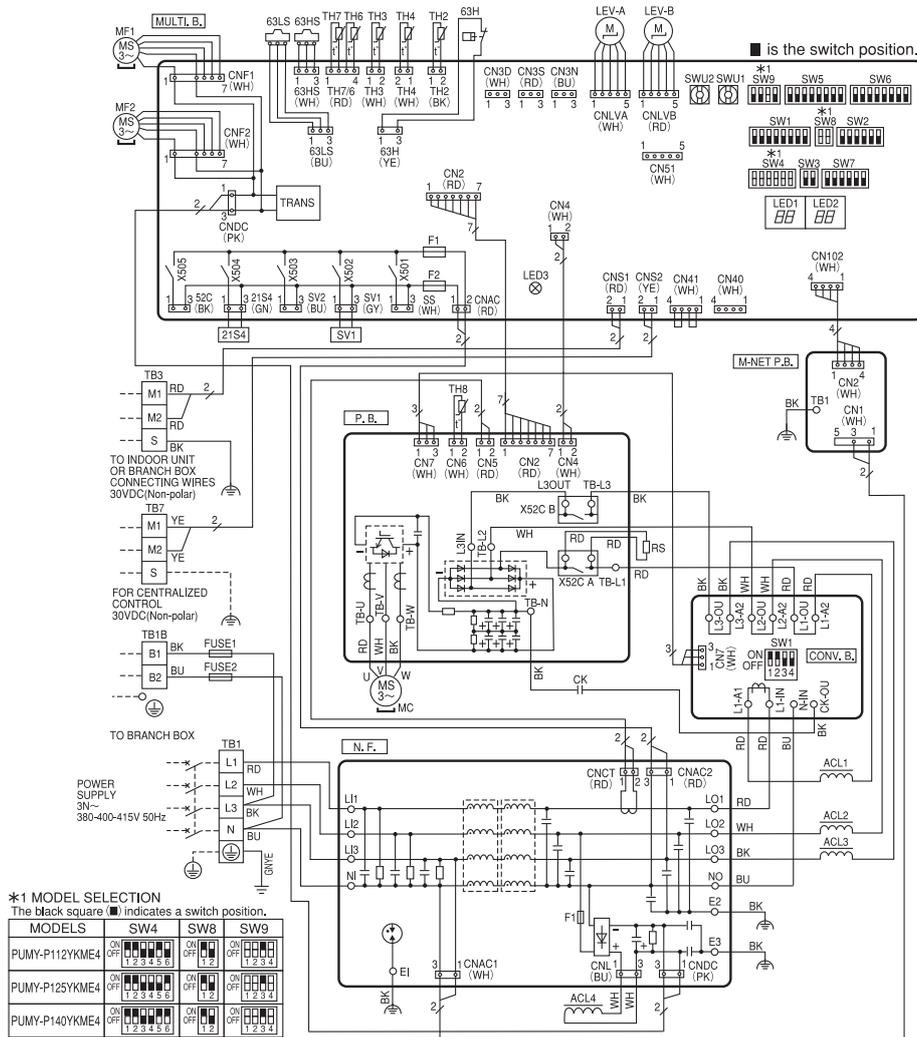

SYMBOL	NAME	SYMBOL	NAME	SYMBOL	NAME
TB1	Terminal Block (Power Supply)	ACL1,ACL2,ACL3,ACL4	Reactor	SW4	Switch (Model Selection)
TB1B	Terminal Block (Branch Box)	P.B.	Power Circuit Board	SW5	Switch (Function Selection)
TB3	Terminal Block (Indoor/Outdoor, Branch Box/Outdoor Transmission Line)	TB-U/V/W	Connection Terminal (U/V/W-Phase)	SW6	Switch (Function Selection)
TB7	Terminal Block (Centralized Control Transmission Line)	TB-L1/L2/L3	Connection Terminal (L1/L2/L3-Power Supply)	SW7	Switch (Function Selection)
FUSE1,FUSE2	Fuse (T20AL250V)	TB-N	Connection Terminal	SW8	Switch (Model Selection)
MC	Motor for Compressor	X52C/A/B	S2C Relay	SW9	Switch (Function/Model Selection)
MF1,MF2	Fan Motor	CONV.B.	Converter Circuit Board	SWU1	Switch (Unit Address Selection, ones digit)
21S4	Solenoid Valve Coil (Four-Valve)	SW1	Switch (Model Selection)	SWU2	Switch (Unit Address Selection, tens digit)
63H	High Pressure Switch	L1-A1/IN	Connection Terminal (L1-Power Supply)	CNS1	Connector (Indoor/Outdoor, Branch Box/Outdoor Transmission Line)
63HS	High Pressure Sensor	L1-A2/OU	Connection Terminal (L1-Power Supply)	CNS2	Connector (Centralized Control Transmission Line)
63LS	Low Pressure Sensor	L2-A2/OU	Connection Terminal (L2-Power Supply)	SS	Connector (Connection for Option)
SV1	Solenoid Valve Coil (Bypass Valve)	L3-A2/OU	Connection Terminal (L3-Power Supply)	CN3D	Connector (Connection for Option)
TH2	Thermistor (Heat Pipe)	N-IN	Connection Terminal	CN3S	Connector (Connection for Option)
TH3	Thermistor (Outdoor Liquid Pipe)	CK-OU	Connection Terminal	CN3N	Connector (Connection for Option)
TH4	Thermistor (Compressor)	N.F.	Noise Filter Circuit Board	CNS1	Connector (Connection for Option)
TH6	Thermistor (Suction Pipe)	L01,L02,L03/N0	Connection Terminal (L1/L2/L3/N-Power Supply)	LED1, LED2	LED (Operation Inspection Display)
TH7	Thermistor (Ambient)	L11,L12,L13/N1	Connection Terminal (L1/L2/L3/N-Power Supply)	LED3	LED (Power Supply to Main Microcomputer)
TH8	Thermistor (Heat Sink)	E1,E2,E3	Connection Terminal (Electrical Parts Box)	F1,F2	Fuse (T6,3AL250V)
RS	Rush Current Protect Resistor	MULTI.B.	Multi Controller Circuit Board	X501~505	Relay
CK	Capacitor	SW1	Switch (Display Selection)	M-NET P.B.	M-NET Power Circuit Board
LEV-A,LEV-B	Linear Expansion Valve	SW2	Switch (Function Selection)	TB1	Connection Terminal (Electrical Parts Box)
		SW3	Switch (Test Run)		

Cautions when Servicing

- ⚠ **WARNING:** When the main supply is turned off, the voltage [570 V] in the main capacitor will drop to 20 V in approx. 5 minutes (input voltage: 400 V). When servicing, make sure that LED1, LED2 on the outdoor multi controller circuit board goes out, and then wait for at least 5 minutes.
- Components other than the outdoor circuit boards may be faulty: Check and take corrective action, referring to the service manual. Do not replace the outdoor circuit boards without checking.

NOTES:

- Refer to the wiring diagrams of the indoor units for details on wiring of each indoor unit.
- Self-diagnosis function

The indoor and outdoor units can be diagnosed automatically using the self-diagnosis switch (SW1) and LED indication (LED1, LED2) found on the outdoor multi controller circuit board.
LED indication : Set all contacts of SW1 to OFF.

During normal operation

The LED indicates the drive state of outdoor unit.

Bit	1	2	3	4	5	6	7	8
Indication	Compressor operated	52C	21S4	SV1	(SV2)	—	—	Always lit

- When fault requiring inspection has occurred
The LED alternately indicates the check code and the address of the unit in which the fault has occurred.

[Example]

When the compressor and SV1 are on during cooling operation.



Refer to the following table to find out the meanings of the symbols in the refrigerant circuit diagram.

Symbol	Part name	Detail
COMP	Compressor	DC inverter twin rotary compressor : W50/85, SW45/50/75, FRP71 DC inverter scroll compressor : W112, HW112/140 (Mitsubishi Electric Corporation) SW100/120/160/200 SHW80/112/140/230
H/P SW	High pressure switch (63H)	For protection (OFF: 4.15MPa)
L/P SW	Low pressure switch (63L)	For protection (OFF: -0.03MPa)
Plate HEX	Plate Heat Exchanger	MWA1-28LM (Mitsubishi Electric Corporation) : (PUHZ-W50VHA2) MWA1-44LM (Mitsubishi Electric Corporation) : (PUHZ-W85VHA2) MWA2-46LM (Mitsubishi Electric Corporation) : (PUHZ-W112VHA/HW-HA2)
REV/V	Reversing (4-way) valve (21S4)	Change the refrigerant circuit (Heating / Cooling) and for Defrosting
S/V	Solenoid valve	For production test use SN1~3 Changing the refrigerant circuit (PUHZ-FRP)
STOP VALVE	Stop valve	For refrigerant charge
CHECK/V	Check valve	High pressure / Low pressure / For production test use
Charge plug	Charge plug	High pressure / Low pressure / For refrigerant charge
P-Sensor	Pressure sensor (63HS)	For calculation of the condensing temperature from high pressure
P/B	Power board	Inverter power board
LEV-A	Linear expansion valve -A	Heating: Secondary LEV Cooling: Primary LEV Change the refrigerant circuit (PUHZ-FRP)
LEV-B	Linear expansion valve -B	Heating: Primary LEV Cooling: Secondary LEV Change the refrigerant circuit (PUHZ-FRP)
LEV-C	Linear expansion valve -C	For HIC (PUHZ-HW, PUHZ-SHW) Change the refrigerant circuit (PUHZ-FRP)
TH2	HIC pipe temperature thermistor	(PUMY-P·VKM/YKM/YKME)
TH3 (RT61)	Liquid temperature thermistor (Defrost thermistor)	Heating: Evaporating temperature Cooling: Sub cool liquid temperature
TH4 (RT62)	Discharge temperature thermistor	For LEV control and for compressor protection
	Compressor temperature thermistor	(PUMY-P·VKM/YKM/YKME)
TH6 (RT68)	Plate HEX liquid temperature thermistor	Heating: Sub cool liquid temperature Cooling: Evaporating temperature
	Outdoor HEX temperature	(SUHZ-SW45)
	2-Phase Pipe temperature	(PUHZ-SW50/75/100/120/160/200, PUHZ-FRP71)
	Suction pipe temperature thermistor	(PUMY-P·VKM/YKM/YKME)
TH7 (RT65)	Ambient temperature thermistor	For fan control and for compressor frequency control
TH8 (RT64)	Heatsink temperature thermistor (Fin temp.)	For power board protection
TH32	Comp. surface temperature thermistor	For compressor protection (PUHZ-SW160/200YKA)
	Suction temperature thermistor	For LEV control (PUHZ-SHW·HA/KA/AA)
	Inlet water temperature thermistor	For freeze protection and for compressor frequency control (PUHZ-W·VHA(2), HW·HA2)
TH33	Comp. surface temperature thermistor	For compressor protection (PUHZ-W50/85HA(2), PUHZ-SW·AA, PUHZ-SHW·AA, PUHZ-W·V/YAA)
	Suction temperature thermistor	For LEV control (PUHZ-W112VHA, HW·HA2)
	Ref. check temperature thermistor	For refrigerant leak check (PUHZ-SHW·HA)
TH34	Comp. surface temperature thermistor	For compressor protection
Rec	Receiver	For accumulation of refrigerant
Power Receiver	Power Receiver	For accumulation of refrigerant
HIC	Heat interchange circuit	For high capacity
Accumulator	Accumulator	For accumulation of refrigerant

4.1 Packaged-type units

■ PUAZ-W50VHA2(-BS)

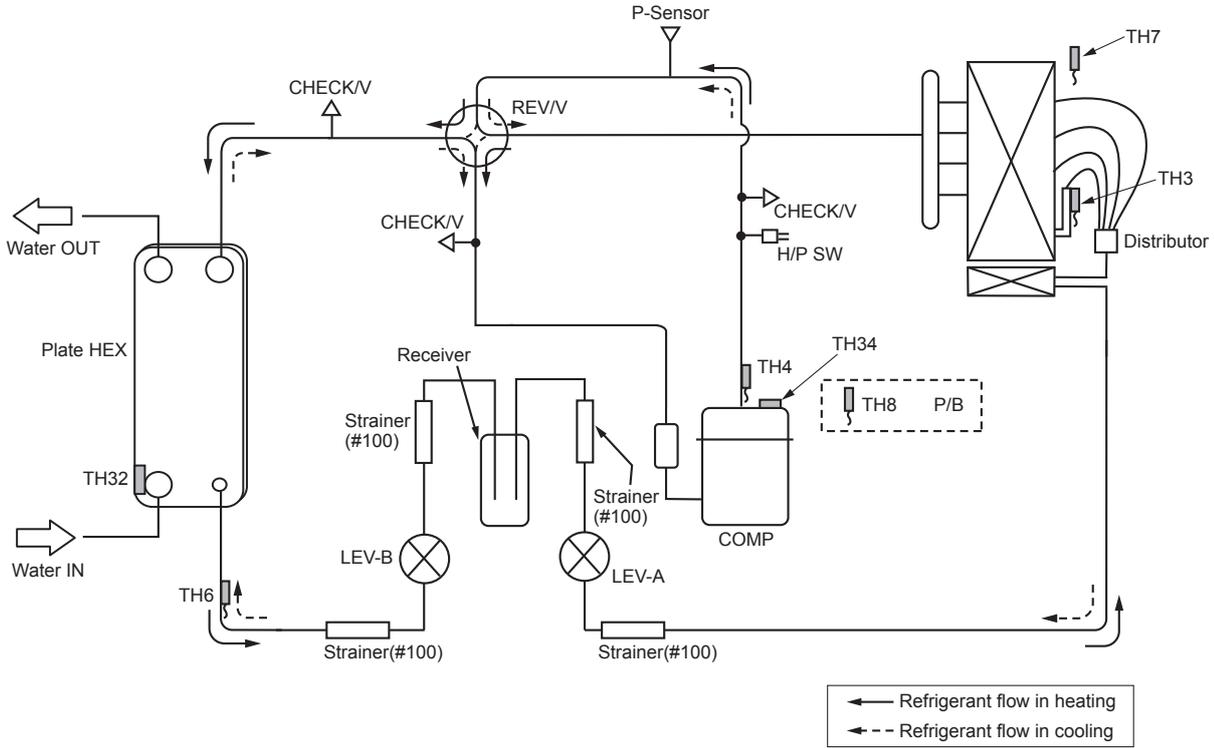

■ PUAZ-W85VHA2(-BS)

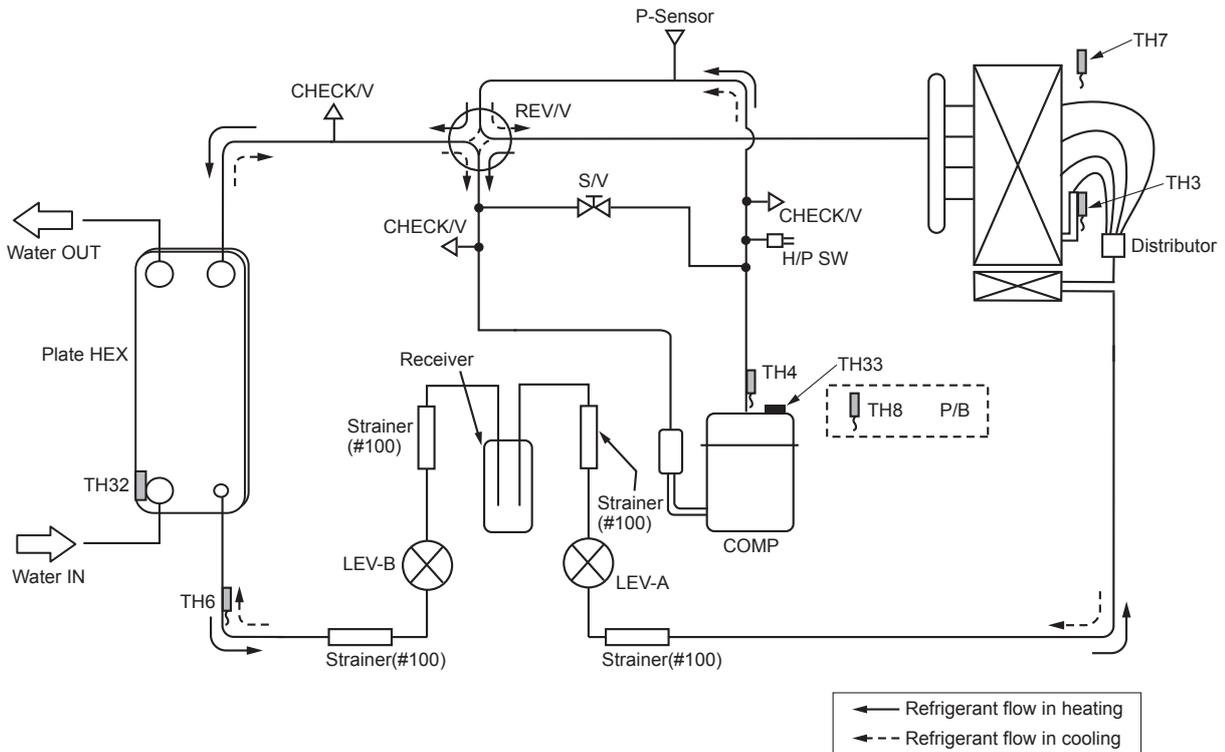

■ PUAZ-W112VHA(-BS)

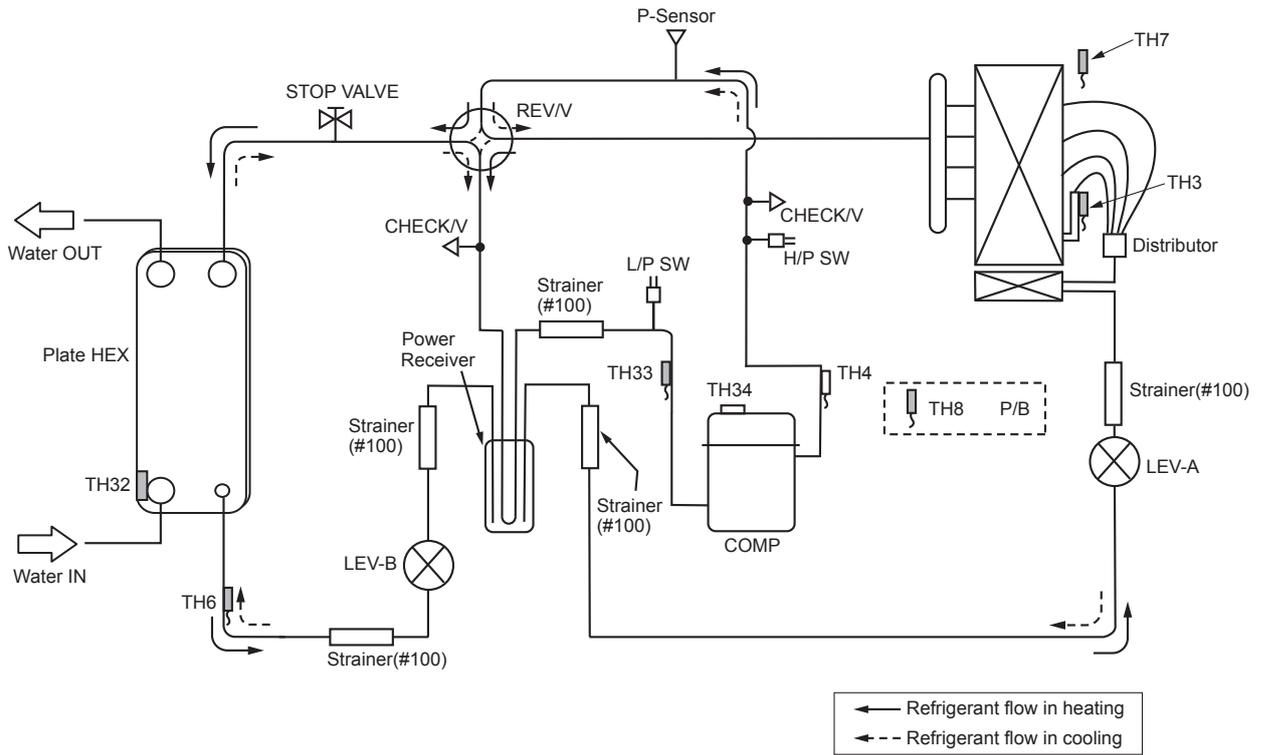

■ PUAZ-W85VAA PUAZ-W85YAA

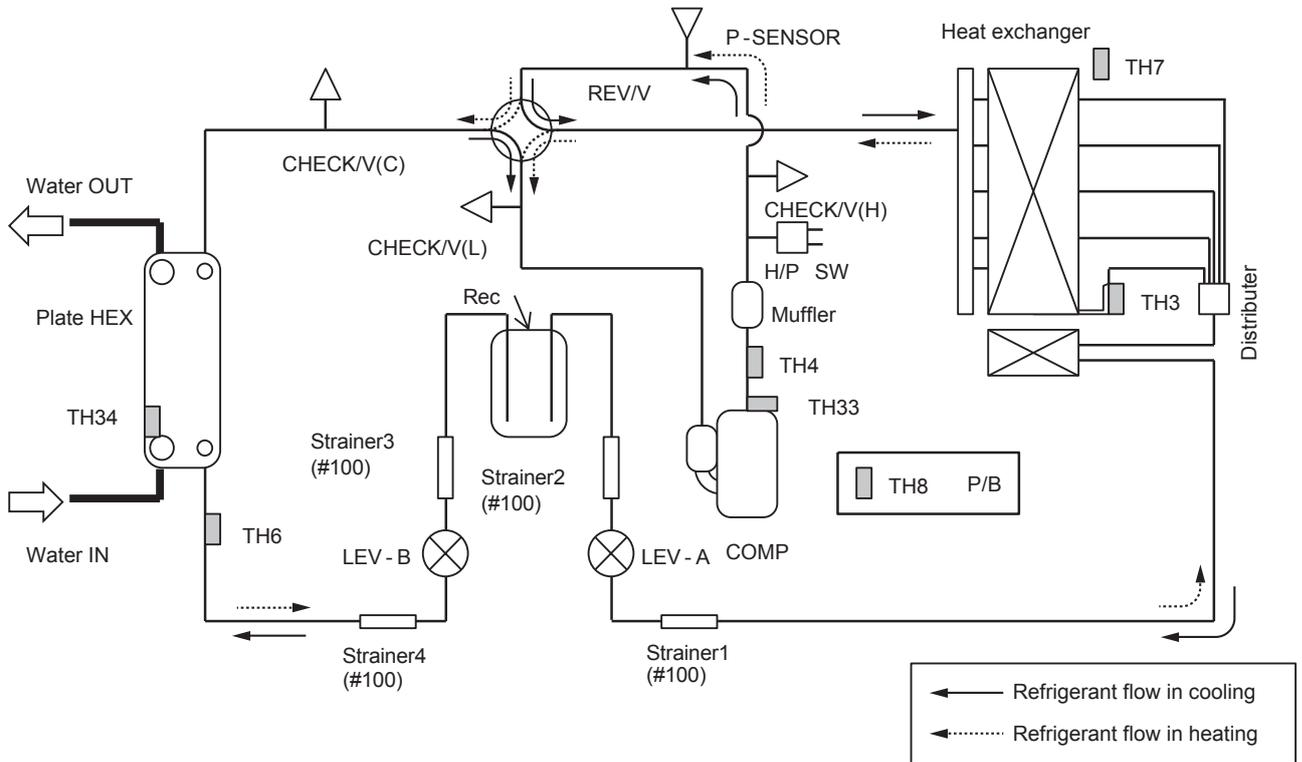

4.2 Split-type units

■ SUHZ-SW45VA(H)

Unit : mm (inch)

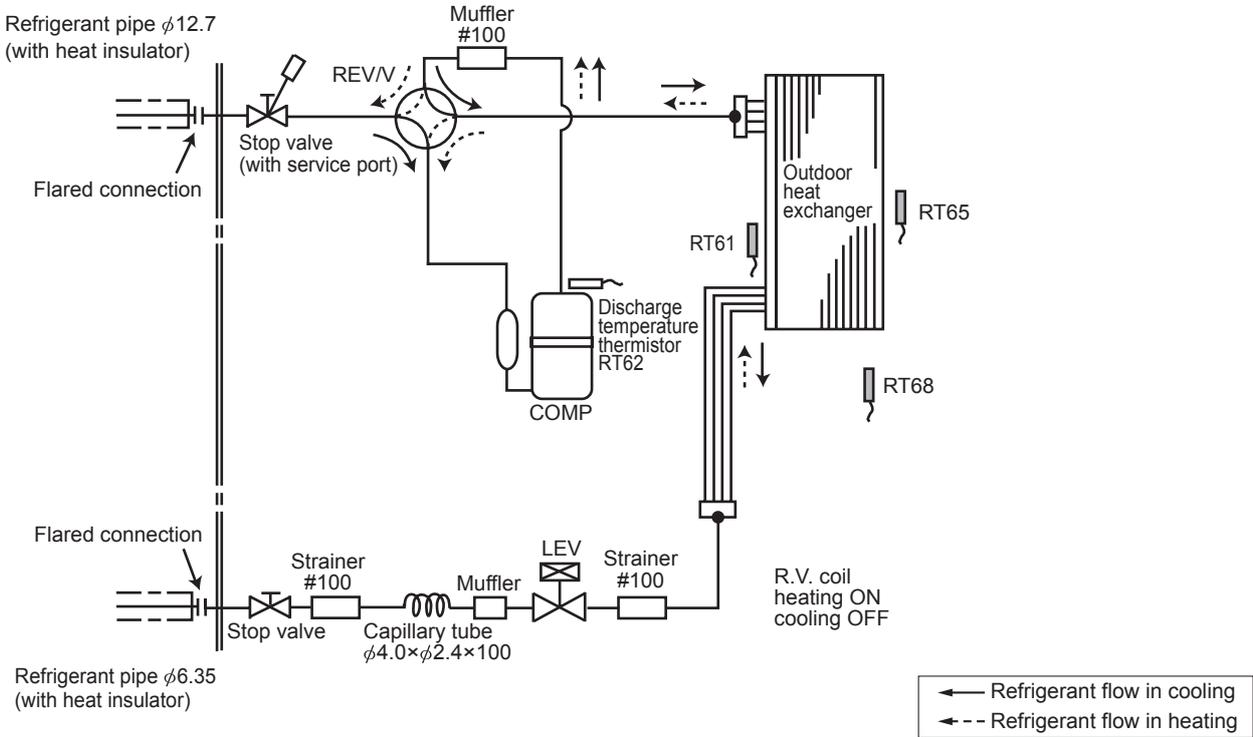

■ PUHZ-SW50VKA(-BS)

Unit : mm (inch)

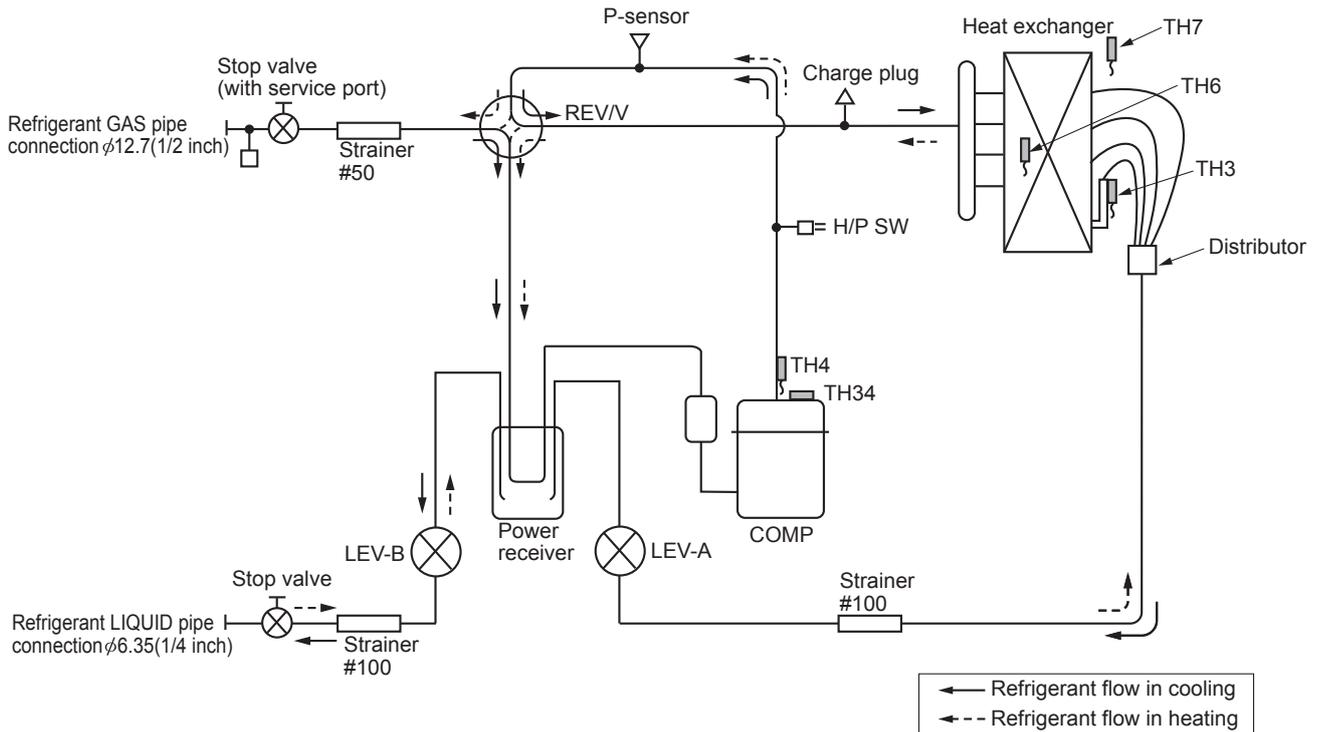

Outdoor unit

■ PUAZ-SW75VHA(-BS)

Unit : mm (inch)

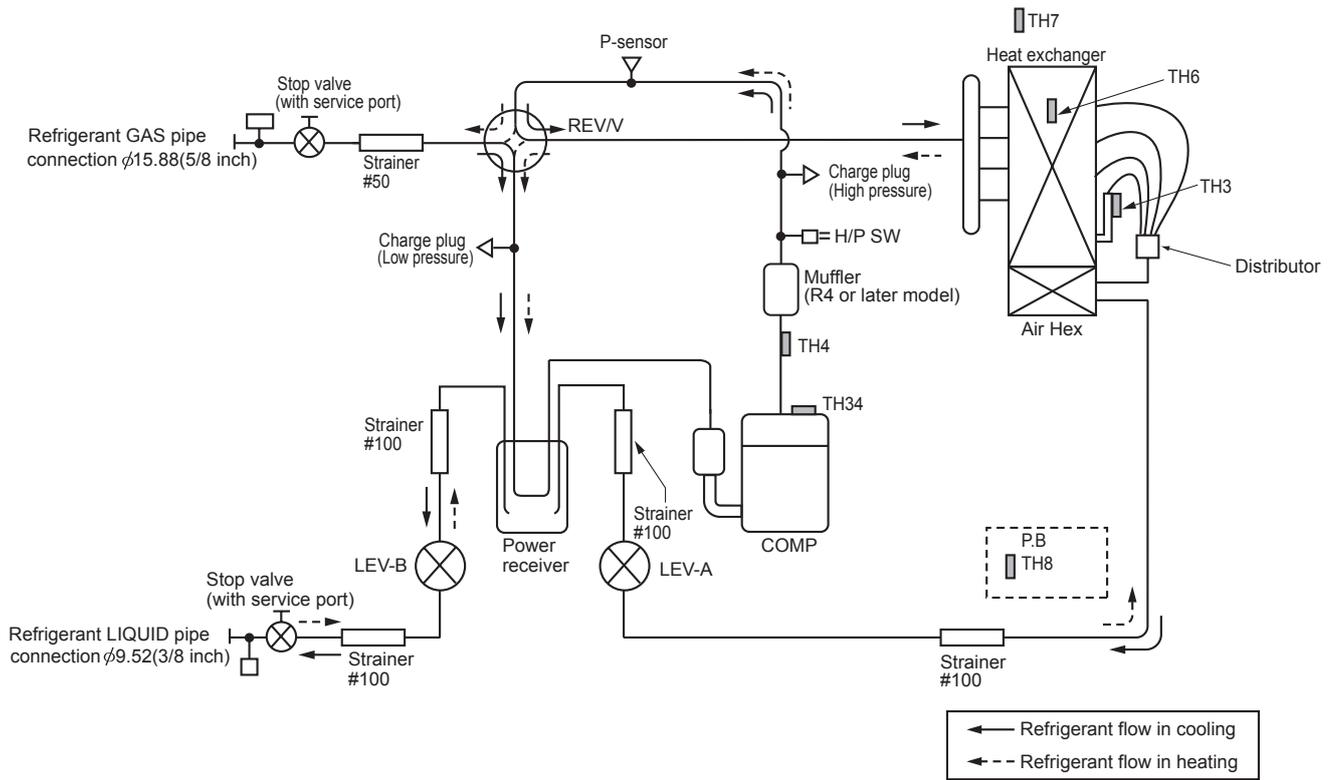

■ PUAZ-SW100VHA(-BS) PUAZ-SW120VHA(-BS)

■ PUAZ-SW100YHA(-BS) PUAZ-SW120YHA(-BS)

Unit : mm (inch)

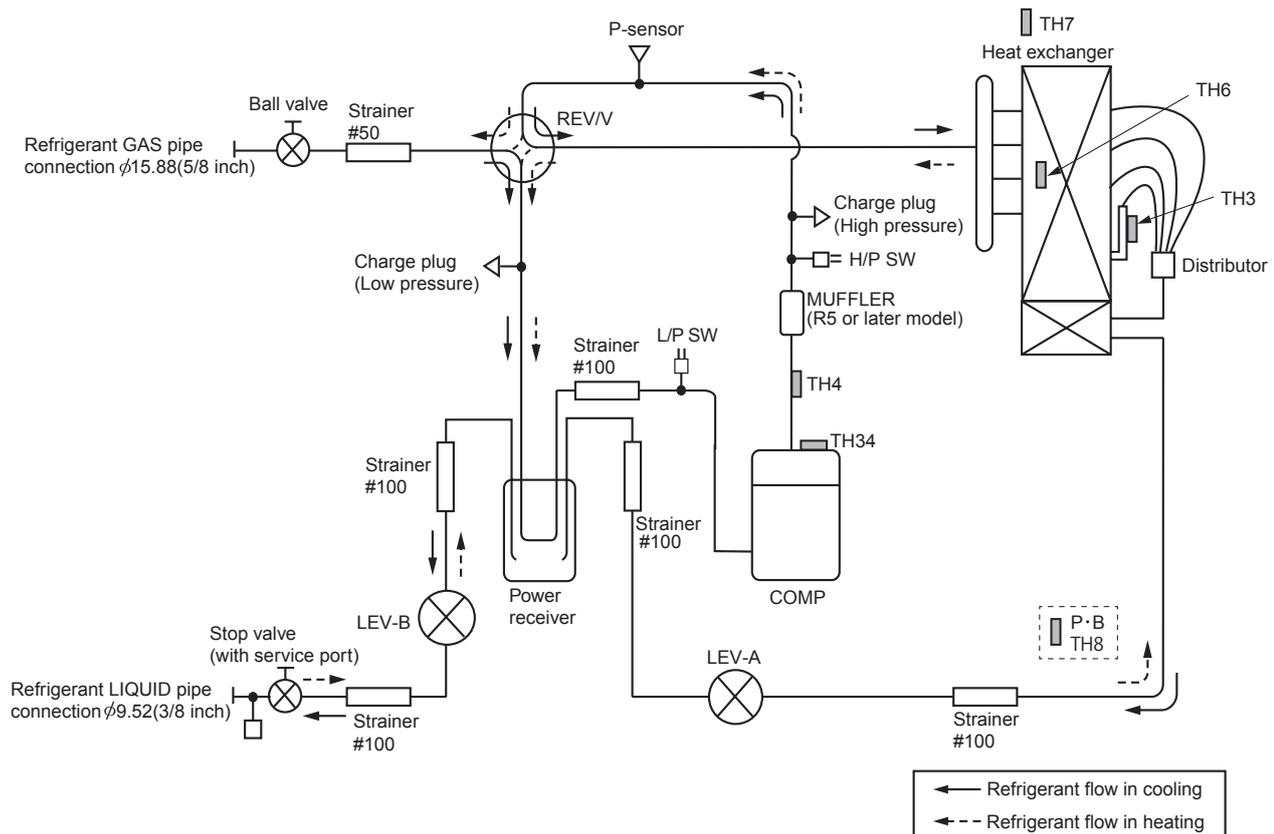

■ PUAZ-SW160/200YKA(-BS)

Unit : mm (inch)

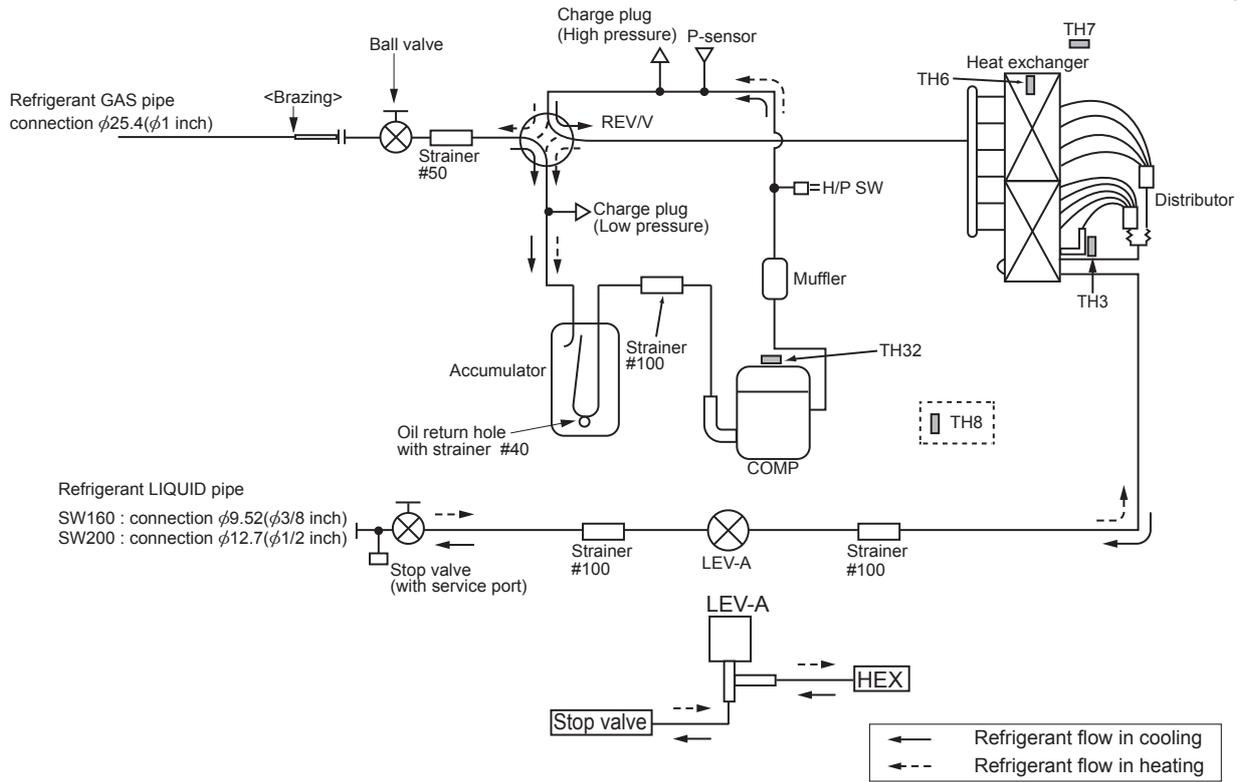

■ PUAZ-SW75VAA(-BS) PUAZ-SW75YAA(-BS)

Unit : mm (inch)

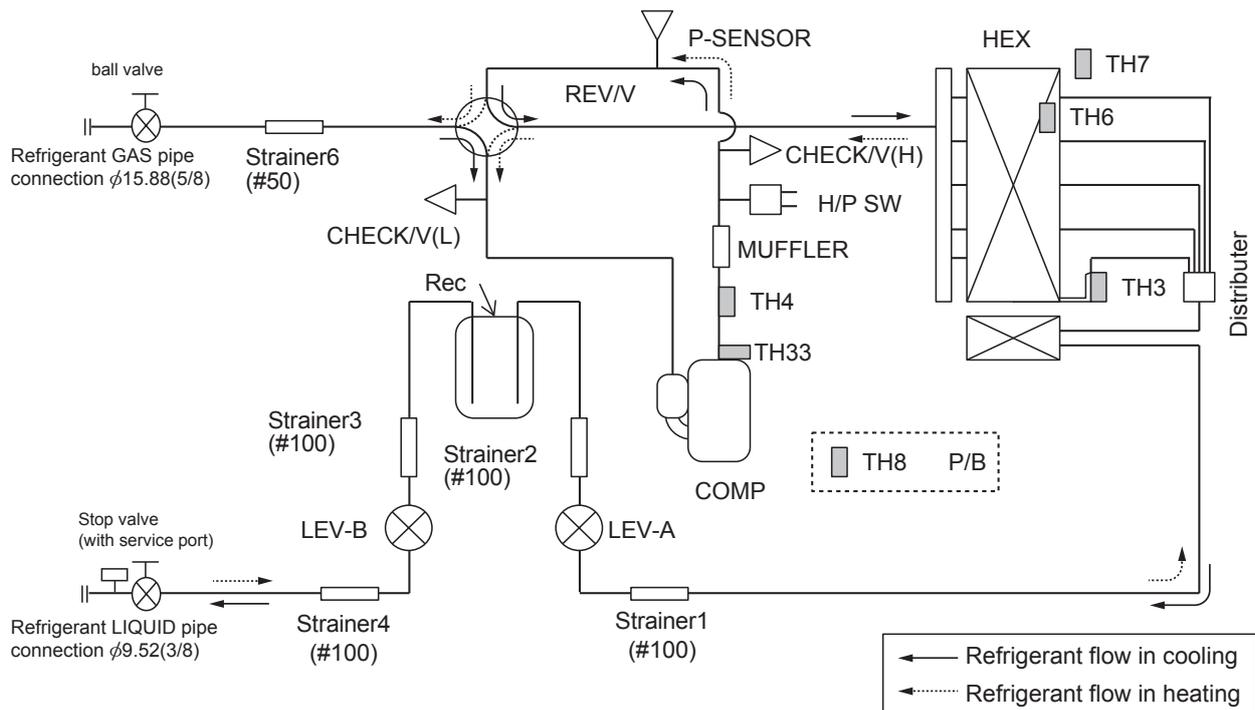

Outdoor unit

■ PUAZ-SW100VAA(-BS)

PUHZ-SW100YAA(-BS)

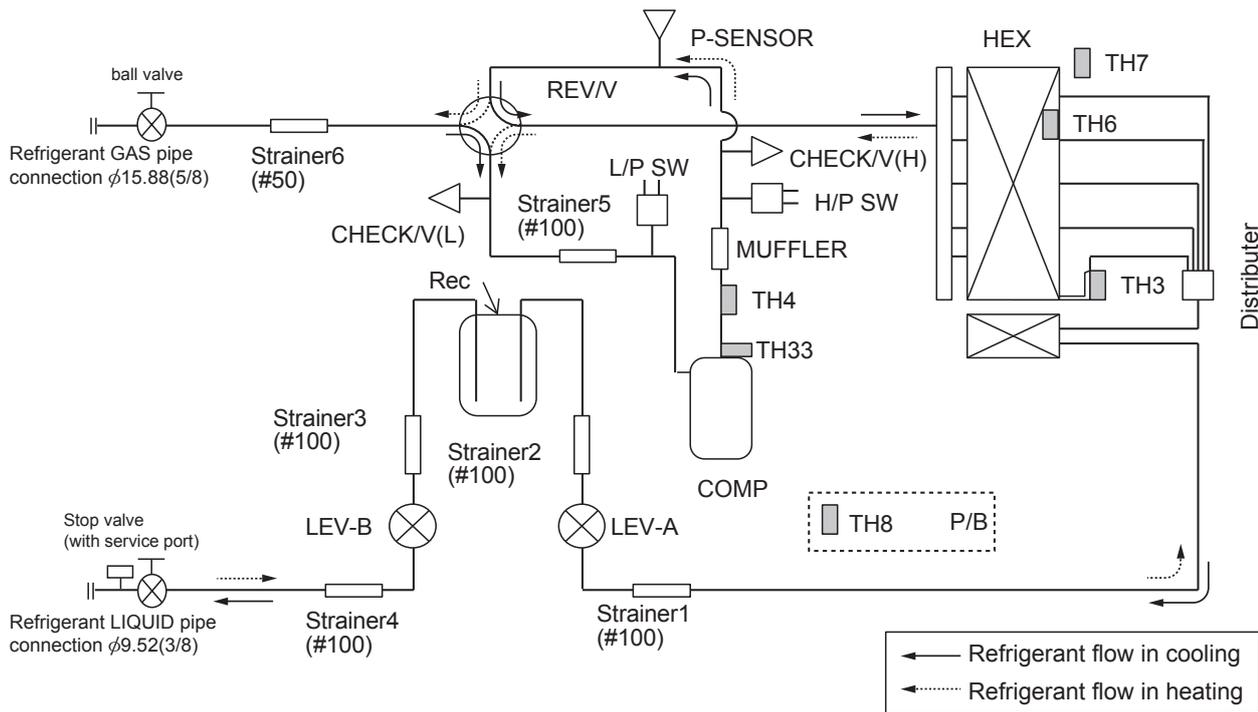

■ PUAZ-FRP71VHA2

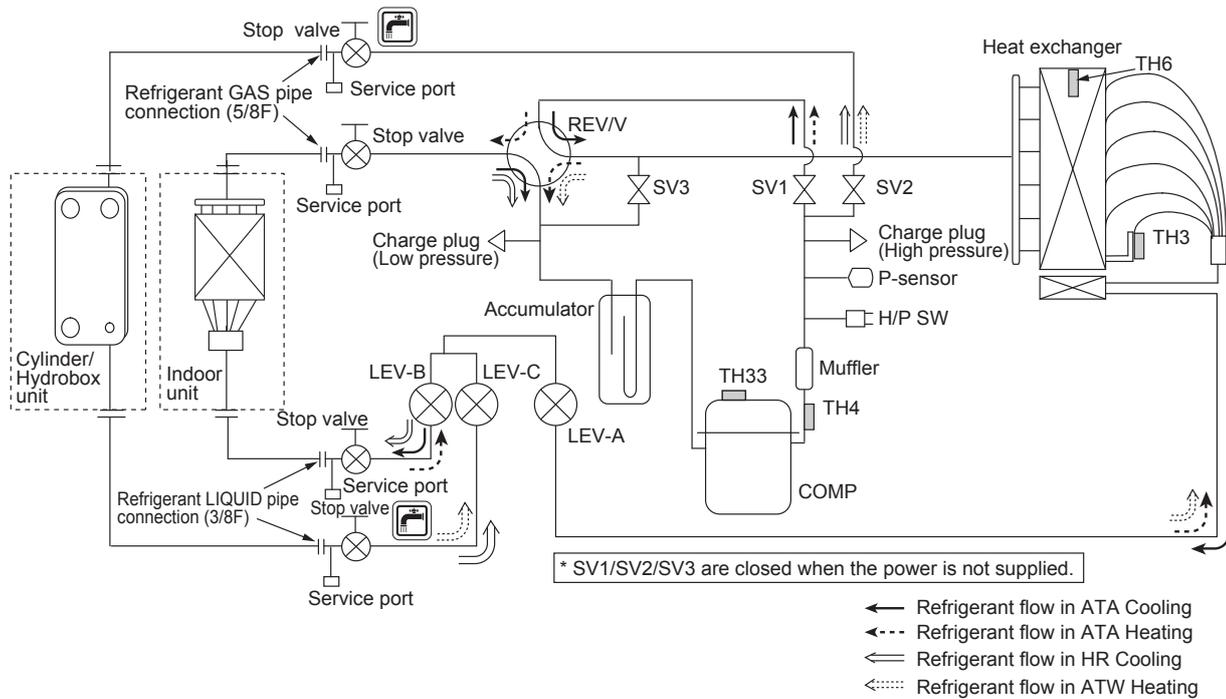

Outdoor unit

■ PUAZ-SHW80/112VAA(-BS)

PUHZ-SHW80/112YAA(-BS)

Unit : mm (inch)

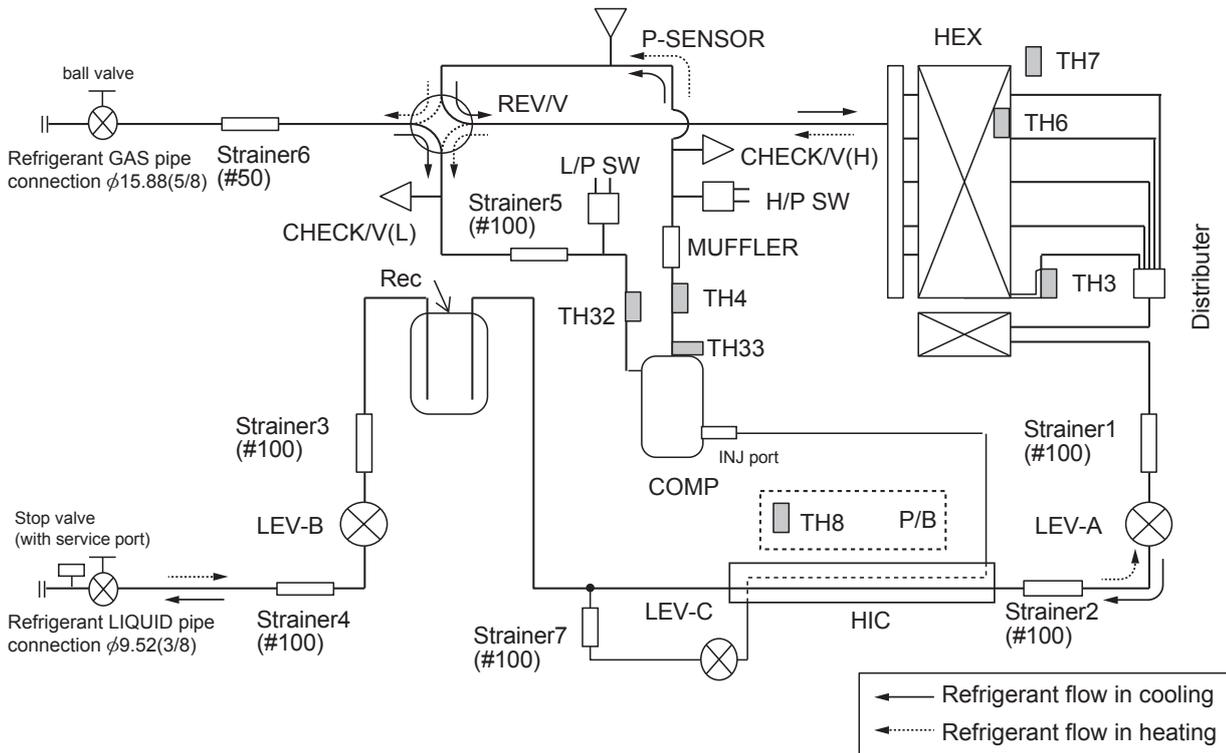

■ PUMY-P112VKM4(-BS)
 PUMY-P112YKM4(-BS)
 PUMY-P112YKME4(-BS)

PUMY-P125VKM4(-BS)
 PUMY-P125YKM4(-BS)
 PUMY-P125YKME4(-BS)

PUMY-P140VKM4(-BS)
 PUMY-P140YKM4(-BS)
 PUMY-P140YKME4(-BS)

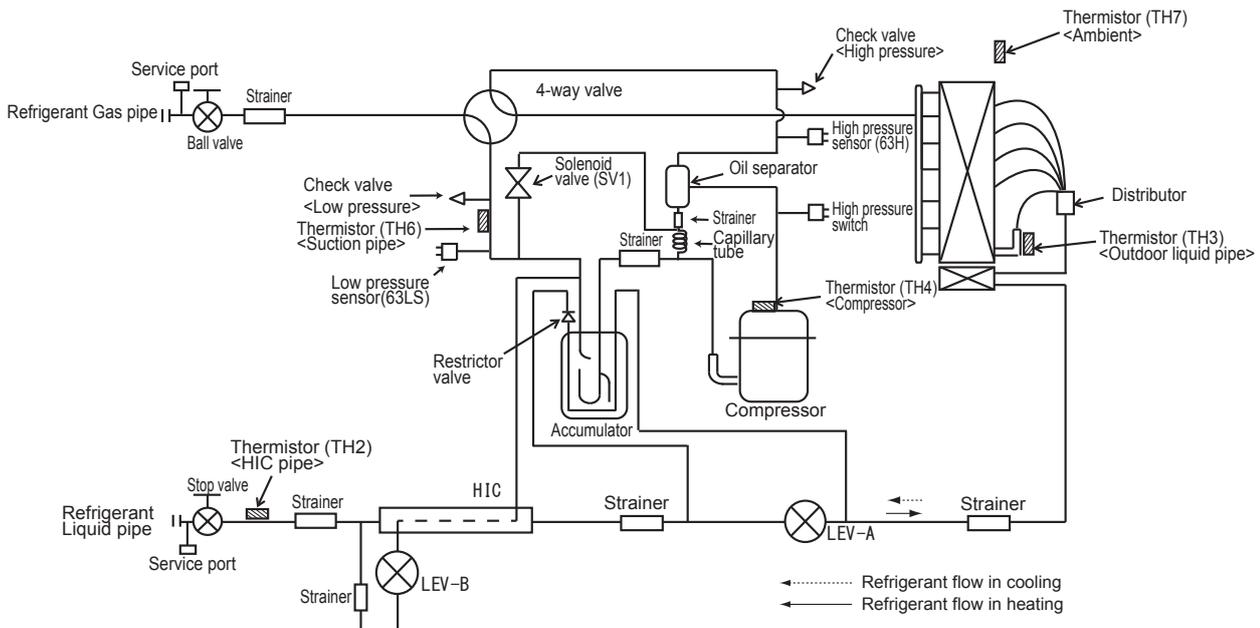

Definition of terms

- Max :Performance at Maximum compressor frequency
- Nominal :Performance at Nominal compressor frequency
- Mid :Performance at Medium compressor frequency (80% of Nominal)
- Min :Performance at Minimum compressor frequency

 :This icon means injection circuit is active.

NOTES:

- The reference data at water outlet temperatures of 35°C,40°C,45°C,50°C,55°C and 60°C are shown.
- The data at water outlet temperature of 25°C are shown except for SHW230 model.
- Gray highlighted data means integrated data including defrost operation.
- Actual performance may vary depending on operating conditions.
- These data are measured based on EN14511-2013.

5.1 Cooling performance data

■ Power inverter

Water outlet temperature[°C]		7		18		Water outlet temperature[°C]		7		18			
Model	Ambient temperature [°C]	Capacity	COP	Capacity	COP	Model	Ambient temperature [°C]	Capacity	COP	Capacity	COP		
PUAZ-W50 VHA2(-BS)	Nominal	35	4.5	2.94	4.5	4.44	PUAZ-W85V/ YAA	Max	35	7.5	2.70	10.5	3.49
		30	4.5	3.52	4.5	5.37			30	7.9	3.05	10.9	3.95
		25	4.5	4.06	4.5	6.30			25	7.5	2.72	10.2	3.23
		20	4.5	4.10	4.5	6.31			20	7.2	2.47	9.5	2.73
	Mid	35	3.2	3.76	3.4	5.46		Nominal	35	7.5	2.70	7.5	4.42
		30	3.2	4.40	3.4	6.69			30	7.5	3.18	7.5	6.38
		25	3.2	4.82	3.4	7.52			25	7.5	2.72	7.5	6.20
		20	3.2	4.92	3.4	7.78			20	7.2	2.47	7.5	5.89
	Min	35	2.0	4.26	2.8	5.98		Mid	35	6.0	3.14	6.0	4.85
		30	2.1	4.55	2.9	6.30			30	6.0	3.71	5.9	6.87
		25	2.2	5.21	3.0	7.13			25	6.0	3.54	5.9	7.15
		20	2.3	5.71	3.1	7.71			20	6.0	3.33	5.9	7.26
PUAZ-W85 VHA2(-BS)	Nominal	35	7.5	2.47	7.5	3.93	PUAZ-W112V/ YAA	Max	35	10.0	2.83	13.9	3.85
		30	7.5	2.91	7.5	4.61			30	10.6	3.35	14.8	4.52
		25	7.5	2.95	7.5	5.00			25	10.4	3.19	14.1	4.04
		20	7.5	2.87	7.5	4.90			20	10.1	2.95	13.4	3.51
	Mid	35	5.4	3.16	5.7	4.83		Nominal	35	10.0	2.83	10.0	4.74
		30	5.4	3.70	5.7	5.92			30	10.0	3.55	10.0	5.64
		25	5.4	4.05	5.7	6.65			25	10.0	3.36	10.0	5.62
		20	5.4	4.13	5.7	6.88			20	10.0	2.99	10.0	5.30
	Min	35	3.3	3.58	4.7	5.29		Mid	35	8.0	3.26	8.0	4.88
		30	3.5	3.86	4.9	5.61			30	8.0	3.92	8.0	5.75
		25	3.6	4.35	5.1	6.39			25	8.0	4.00	8.0	6.07
		20	3.7	4.68	5.1	6.69			20	8.0	3.93	8.0	6.07
PUAZ- W112VHA (-BS)	Nominal	35	10.0	2.80	10.0	4.50	SUHZ-SW 45VA(H)	Max	35	4.9	2.48	6.5	2.99
		30	10.0	3.41	10.0	4.97			30	5.1	2.82	6.8	3.39
		25	10.0	3.82	10.0	5.57			25	5.3	3.16	7.1	3.73
		20	10.0	4.38	10.0	6.26			20	5.3	3.13	7.1	3.54
	Mid	35	8.0	3.08	8.0	4.60		Nominal	35	4.0	2.73	3.8	4.28
		30	8.0	3.72	8.0	5.04			30	4.0	3.26	3.8	5.17
		25	8.0	4.29	8.0	5.46			25	4.0	3.77	3.8	6.07
		20	8.0	4.95	8.0	6.11			20	4.0	3.81	3.8	6.09
	Min	35	3.2	3.10	4.6	4.37		Mid	35	2.4	3.13	3.5	4.46
		30	3.4	3.63	4.8	5.05			30	2.4	3.74	3.5	5.34
		25	3.6	4.45	4.9	5.75			25	2.4	4.38	3.5	6.24
		20	3.7	5.02	5.1	6.54			20	2.4	4.62	4.2	6.08
	Max	35	1.3	2.94	2.1	4.98	Min	35	3.0	3.92	4.5	6.18	
		30	3.0	3.92	4.5	6.18		25	3.1	4.45	4.8	7.05	
		25	3.1	4.45	4.8	7.05		20	3.9	4.46	5.9	6.54	
		20	3.9	4.46	5.9	6.54							

5 Performance data

Outdoor unit

Outdoor unit

Water outlet temperature [°C]		7		18		
Model	Ambient temperature [°C]	Capacity	COP	Capacity	COP	
PUHZ-SW 50VKA (-BS)	Max	35	4.5	2.76	5.0	4.60
		30	4.7	3.14	5.2	5.21
		25	4.9	3.52	5.4	5.74
		20	4.9	3.48	5.4	5.44
	Nominal	35	4.5	2.76	5.0	4.60
		30	4.5	3.30	5.0	5.56
		25	4.5	3.81	5.0	6.52
		20	4.5	3.85	5.0	6.54
	Mid	35	3.6	3.14	4.0	5.24
		30	3.6	3.75	4.0	6.27
		25	3.6	4.39	4.0	7.33
		20	3.6	4.63	4.8	7.14
	Min	35	1.1	3.44	1.7	5.44
		30	2.5	4.59	3.7	6.75
		25	2.6	5.21	3.9	7.70
		20	3.3	5.22	4.8	7.14
PUHZ-SW 75VHA (-BS)	Max	35	7.3	2.55	10.0	3.18
		30	7.8	2.89	10.6	3.67
		25	8.2	3.26	11.0	4.05
		20	8.5	3.60	11.3	4.38
	Nominal	35	6.6	2.82	7.1	4.43
		30	6.6	3.38	7.1	5.43
		25	6.6	4.05	7.1	6.58
		20	6.6	4.81	7.7	6.40
	Mid	35	5.3	2.83	5.7	4.49
		30	5.3	3.36	6.0	5.80
		25	5.3	3.93	6.2	6.62
		20	6.3	4.93	7.7	6.40
	Min	35	2.0	2.98	2.6	4.38
		30	4.7	4.08	6.0	5.80
		25	4.9	4.73	6.2	6.62
		20	6.3	4.93	7.7	6.40
PUHZ-SW 100V/YHA (-BS)	Max	35	9.1	2.75	14.0	3.54
		30	9.7	3.22	14.8	4.09
		25	9.8	3.50	14.9	4.25
		20	10.1	3.78	15.1	4.42
	Nominal	35	9.1	2.75	10.0	4.35
		30	9.1	3.36	10.0	5.17
		25	9.1	3.82	10.0	5.85
		20	9.1	4.32	11.0	4.85
	Mid	35	7.3	3.02	8.0	4.44
		30	7.3	3.65	9.5	5.14
		25	7.3	4.01	9.6	5.61
		20	8.6	4.16	11.0	4.85
	Min	35	3.2	3.06	4.6	4.36
		30	6.9	3.87	9.5	5.14
		25	6.9	4.23	9.6	5.61
		20	8.6	4.16	11.0	4.85
PUHZ-SW 120V/YHA (-BS)	Max	35	12.5	2.32	16.0	3.59
		30	13.4	2.63	17.0	4.03
		25	13.5	2.77	16.9	4.02
		20	13.9	2.93	16.9	4.05
	Nominal	35	12.5	2.32	14.0	4.08
		30	12.5	2.80	14.0	4.82
		25	12.5	3.03	14.0	5.17
		20	12.5	3.32	14.0	5.58
	Mid	35	10.0	2.83	11.2	4.62
		30	10.0	3.36	11.7	5.29
		25	10.0	3.43	11.6	5.35
		20	10.4	3.99	13.8	4.88
	Min	35	4.1	3.24	5.8	4.83
		30	8.6	3.84	11.7	5.29
		25	8.5	4.10	11.6	5.35
		20	10.4	3.99	13.8	4.88

Water outlet temperature [°C]		7		18		
Model	Ambient temperature [°C]	Capacity	COP	Capacity	COP	
PUHZ-SW 160YKA (-BS)	Max	35	19.3	2.30	26.6	3.18
		30	18.8	2.61	20.9	4.39
		25	19.4	2.94	21.6	4.95
		20	20.1	3.07	22.3	5.16
	Nominal	35	16.0	2.76	18.0	4.56
		30	16.0	3.05	18.0	4.95
		25	16.0	3.63	18.0	5.44
		20	16.0	3.97	18.0	5.78
	Mid	35	12.8	3.09	14.4	4.94
		30	12.8	3.41	14.4	5.37
		25	12.8	4.06	14.4	5.90
		20	12.8	4.44	14.4	6.26
	Min	35	7.7	3.22	11.1	5.05
		30	8.2	3.59	11.3	5.45
		25	8.6	4.05	11.5	5.86
		20	9.1	4.30	11.7	6.08
PUHZ-SW 200YKA (-BS)	Max	35	20.3	2.19	27.8	2.95
		30	21.2	2.40	25.6	3.58
		25	21.9	2.71	26.4	4.03
		20	22.7	2.83	27.4	4.22
	Nominal	35	20.0	2.25	22.0	4.10
		30	20.0	2.63	22.0	4.46
		25	20.0	3.06	22.0	4.93
		20	20.0	3.39	22.0	5.22
	Mid	35	16.0	2.76	17.6	4.74
		30	16.0	3.05	17.6	5.15
		25	16.0	3.63	17.6	5.66
		20	16.0	3.97	17.6	6.01
	Min	35	7.7	3.22	11.1	5.05
		30	8.2	3.59	11.3	5.45
		25	8.6	4.05	11.5	5.86
		20	9.1	4.30	11.7	6.08
PUHZ-SW 75VAA/YAA (-BS)	Max	35	7.1	2.70	9.6	3.41
		30	7.4	3.07	10.0	3.84
		25	7.1	2.77	9.4	3.19
		20	6.8	2.52	8.9	2.73
	Nominal	35	7.1	2.70	7.1	4.43
		30	7.1	3.18	7.1	5.29
		25	7.1	2.77	7.1	4.78
		20	6.8	2.52	7.1	4.27
	Mid	35	5.6	3.15	5.6	4.96
		30	5.6	3.74	5.6	6.00
		25	5.6	3.57	5.6	5.88
		20	5.6	3.39	5.6	5.66
	Min	35	2.3	3.74	3.3	5.44
		30	2.5	4.52	3.4	6.75
		25	2.5	5.14	3.5	7.57
		20	2.6	5.61	3.5	8.15
PUHZ-SW 100VAA/YAA (-BS)	Max	35	10.0	2.83	14.8	3.69
		30	11.5	3.68	15.7	4.34
		25	11.1	3.42	14.8	3.75
		20	10.0	2.91	13.8	3.20
	Nominal	35	10.0	2.83	10.0	4.74
		30	10.0	4.05	10.0	5.69
		25	10.0	3.85	10.0	5.57
		20	10.0	2.93	10.0	5.21
	Mid	35	8.0	3.26	8.0	5.01
		30	8.0	4.42	8.0	5.95
		25	8.0	4.51	8.0	6.20
		20	8.0	3.87	8.0	6.17
	Min	35	2.8	3.25	4.1	4.66
		30	3.1	4.09	4.3	5.51
		25	3.2	4.86	4.4	6.46
		20	3.1	4.93	4.4	7.04

Zubadan

Water outlet temperature[°C]		7		18		Water outlet temperature[°C]		7		18			
Model	Ambient temperature [°C]	Capacity	COP	Capacity	COP	Model	Ambient temperature [°C]	Capacity	COP	Capacity	COP		
PUAZ-HW 112YHA2 (-BS)	Nominal	35	10.0	2.78	10.0	4.10	PUAZ-SHW 140YHA(-BS)	Max	35	12.5	2.17	16.0	3.23
		30	10.0	3.39	10.0	4.84			30	13.3	2.43	16.9	3.58
		25	10.0	3.80	10.0	5.43			25	13.3	2.48	17.0	3.58
		20	10.0	4.35	10.0	6.11			20	14.1	2.84	17.5	3.96
	Mid	35	7.3	3.49	6.7	4.75		35	12.5	2.17	12.5	4.26	
		30	7.3	4.22	6.7	5.57		30	12.5	2.59	12.5	4.96	
		25	7.3	4.86	6.7	6.03		25	12.5	2.75	12.5	5.35	
		20	7.3	5.61	6.7	6.75		20	12.5	3.38	12.5	6.35	
	Min	35	4.0	3.29	5.9	4.79		35	10.0	2.74	10.0	4.73	
		30	4.2	3.81	6.1	5.49		30	10.0	3.25	10.0	5.53	
		25	4.5	4.72	6.3	6.00		25	10.0	3.60	10.0	6.18	
		20	4.6	5.29	6.5	6.80		20	10.0	4.35	10.8	4.89	
PUAZ-HW 140V/YHA2 (-BS)	Nominal	35	12.5	2.50	12.5	3.60	PUAZ-SHW 230YKA2	Max	35	20.0	2.22	24.0	2.65
		30	12.5	2.96	12.5	4.26			30	21.1	2.46	25.1	2.89
		25	12.5	3.21	12.5	4.65			25	22.6	2.88	26.6	3.34
		20	12.5	3.62	12.5	5.15			20	22.4	2.88	26.0	3.20
	Mid	35	9.1	3.14	8.4	4.17		35	20.0	2.22	20.0	3.55	
		30	9.1	3.69	8.4	4.89		30	20.0	2.60	20.0	4.09	
		25	9.1	4.14	8.4	5.29		25	20.0	3.19	20.0	4.85	
		20	9.1	4.72	8.4	5.92		20	20.0	3.35	20.1	3.90	
	Min	35	5.0	2.96	7.4	4.21		35	16.0	2.47	16.0	4.15	
		30	5.3	3.37	7.7	4.85		30	16.0	2.88	17.4	4.43	
		25	5.5	3.96	7.9	5.35		25	16.0	3.48	17.6	4.82	
		20	5.7	4.38	8.1	6.02		20	16.0	3.83	20.1	3.90	
PUAZ-SHW 80VHA(-BS)	Max	35	9.6	2.83	10.0	4.74	PUAZ-SHW 80VAA/YAA (-BS)	Max	35	7.1	3.31	7.1	4.52
		30	10.2	3.30	10.7	5.49			30	7.2	3.85	9.3	5.19
		25	10.2	3.45	11.0	5.80			25	7.6	4.44	9.4	5.67
		20	10.8	3.69	11.7	5.14			20	9.3	4.29	10.8	4.91
	Nominal	35	7.1	3.31	7.1	4.52		35	3.4	3.10	4.5	4.40	
		30	7.2	3.85	9.3	5.19		30	7.2	3.85	9.3	5.19	
		25	7.6	4.44	9.4	5.67		25	7.6	4.44	9.4	5.67	
		20	9.3	4.29	10.8	4.91		20	9.3	4.29	10.8	4.91	
	Mid	35	5.7	3.28	5.7	4.43		35	3.4	3.10	4.5	4.40	
		30	7.2	3.85	9.3	5.19		30	7.2	3.85	9.3	5.19	
		25	7.6	4.44	9.4	5.67		25	7.6	4.44	9.4	5.67	
		20	9.3	4.29	10.8	4.91		20	9.3	4.29	10.8	4.91	
Min	35	3.4	3.10	4.5	4.40	35	7.2	3.85	9.3	5.19			
	30	7.2	3.85	9.3	5.19	30	7.6	4.44	9.4	5.67			
	25	7.6	4.44	9.4	5.67	25	9.3	4.29	10.8	4.91			
	20	9.3	4.29	10.8	4.91	20	9.3	4.29	10.8	4.91			
PUAZ-SHW 112V/YHA(-BS)	Max	35	11.2	2.46	14.0	3.78	PUAZ-SHW 112VAA/YAA (-BS)	Max	35	10.0	2.83	14.8	3.69
		30	11.9	2.86	14.8	4.37			30	11.5	3.68	15.7	4.34
		25	11.9	3.00	14.9	4.50			25	11.1	3.42	14.8	3.75
		20	12.7	3.23	15.3	5.02			20	10.0	2.91	13.8	3.20
	Nominal	35	10.0	2.83	10.0	4.74		35	10.0	2.83	10.0	4.74	
		30	10.0	3.36	10.0	5.54		30	10.0	4.05	10.0	5.69	
		25	10.0	3.72	10.0	6.19		25	10.0	3.85	10.0	5.57	
		20	10.0	4.49	10.8	4.90		20	10.0	2.93	10.0	5.21	
	Mid	35	8.0	3.18	8.0	4.61		35	8.0	3.26	8.0	5.01	
		30	8.0	3.85	9.3	5.18		30	8.0	4.42	8.0	5.95	
		25	8.0	4.40	9.4	5.66		25	8.0	4.51	8.0	6.20	
		20	9.3	4.27	10.8	4.90		20	8.0	3.87	8.0	6.17	
Min	35	3.4	3.09	4.5	4.39	35	2.8	3.10	4.1	4.15			
	30	7.2	3.84	9.3	5.18	30	3.1	3.91	4.3	4.90			
	25	7.6	4.43	9.4	5.66	25	3.2	4.64	4.4	5.75			
	20	9.3	4.27	10.8	4.90	20	3.1	4.70	4.4	6.27			

5.2 Heating performance data

(1) Packaged-type units

■ PUIHZ-W50VHA2(-BS)

Water outlet temperature [°C]		25		35		40		45		50		55		60	
Ambient temperature [°C]		Capacity	COP	Capacity	COP	Capacity	COP	Capacity	COP	Capacity	COP	Capacity	COP	Capacity	COP
Max	-20	-	-	-	-	-	-	-	-	-	-	-	-	-	-
	-15	-	-	4.0	2.30	4.0	2.00	4.0	1.90	-	-	-	-	-	-
	-10	4.5	3.25	5.0	2.60	5.0	2.30	5.0	2.10	4.8	1.90	4.5	1.75	-	-
	-7	5.5	3.50	5.5	2.80	5.5	2.50	5.5	2.30	5.2	2.10	5.0	1.85	-	-
	2	5.2	4.20	5.0	3.50	5.0	3.15	5.0	2.80	5.0	2.47	5.0	2.13	5.0	1.80
	7	5.3	5.48	5.0	4.50	5.0	4.01	5.0	3.52	5.0	3.10	5.0	2.68	5.0	2.26
	12	5.3	6.20	5.0	4.98	5.0	4.37	5.0	3.75	5.1	3.27	5.1	2.78	5.1	2.30
	15	5.4	6.65	5.1	5.28	5.1	4.59	5.1	3.91	5.1	3.38	5.2	2.85	5.2	2.33
20	5.4	7.41	5.1	5.79	5.1	4.98	5.1	4.16	5.2	3.57	5.3	2.97	5.3	2.38	
Nominal	-20	-	-	-	-	-	-	-	-	-	-	-	-	-	-
	-15	-	-	3.5	2.44	3.5	2.22	3.5	2.00	-	-	-	-	-	-
	-10	4.2	3.30	4.1	2.78	4.1	2.51	4.1	2.25	4.2	2.05	4.3	1.85	-	-
	-7	5.2	3.60	4.5	3.00	4.5	2.70	4.5	2.40	4.5	2.16	4.5	1.92	-	-
	2	5.2	4.20	5.0	3.50	5.0	3.15	5.0	2.80	5.0	2.47	5.0	2.13	5.0	1.80
	7	5.3	5.48	5.0	4.50	5.0	4.01	5.0	3.52	5.0	3.10	5.0	2.68	5.0	2.26
	12	5.3	6.20	5.0	4.98	5.0	4.37	5.0	3.75	5.1	3.27	5.1	2.78	5.1	2.30
	15	5.4	6.65	5.1	5.28	5.1	4.59	5.1	3.91	5.1	3.38	5.2	2.85	5.2	2.33
20	5.4	7.41	5.1	5.79	5.1	4.98	5.1	4.16	5.2	3.57	5.3	2.97	5.3	2.38	
Mid	-20	-	-	-	-	-	-	-	-	-	-	-	-	-	-
	-15	-	-	2.9	2.66	2.9	2.38	2.8	2.10	-	-	-	-	-	-
	-10	3.6	3.64	3.5	3.01	3.4	2.68	3.3	2.34	3.4	2.10	3.5	1.86	-	-
	-7	3.9	3.85	3.8	3.25	3.7	2.87	3.6	2.50	3.6	2.25	3.5	2.00	-	-
	2	3.4	4.90	3.3	3.54	3.5	3.35	3.7	3.15	3.7	2.78	3.8	2.41	3.8	2.05
	7	3.8	5.89	3.5	4.63	3.6	4.18	3.8	3.73	3.8	3.23	3.8	2.74	3.8	2.56
	12	3.9	6.58	3.5	5.35	3.7	4.66	3.8	3.98	3.8	3.43	3.8	2.88	3.8	2.59
	15	3.9	7.08	3.6	5.79	3.7	4.97	3.8	4.15	3.8	3.56	3.8	2.98	3.8	2.62
20	3.9	7.98	3.7	6.54	3.8	5.48	3.9	4.43	3.9	3.78	3.8	3.14	3.8	2.68	
Min	-20	-	-	-	-	-	-	-	-	-	-	-	-	-	-
	-15	-	-	2.9	2.66	2.9	2.38	2.8	2.10	-	-	-	-	-	-
	-10	3.6	3.64	3.5	3.01	3.4	2.68	3.3	2.34	3.4	2.10	3.5	1.86	-	-
	-7	2.9	3.52	2.8	2.99	2.8	2.67	2.7	2.35	2.6	2.12	2.5	1.89	-	-
	2	3.0	4.16	2.7	3.59	3.0	3.23	3.2	2.86	2.8	2.54	2.4	2.21	-	-
	7	3.0	5.69	2.8	4.64	3.0	4.03	3.2	3.41	3.2	3.07	3.2	2.73	-	-
	12	3.0	6.59	2.9	5.26	3.0	4.49	3.2	3.73	3.3	3.32	3.5	2.91	-	-
	15	3.0	7.06	2.9	5.64	3.0	4.78	3.2	3.91	3.4	3.46	3.7	3.01	-	-
20	3.1	7.78	2.9	6.26	3.1	5.25	3.2	4.23	3.6	3.71	3.7	3.19	-	-	

■ PUIHZ-W85VHA2(-BS)

Water outlet temperature [°C]		25		35		40		45		50		55		60	
Ambient temperature [°C]		Capacity	COP	Capacity	COP	Capacity	COP	Capacity	COP	Capacity	COP	Capacity	COP	Capacity	COP
Max	-20	-	-	4.9	1.89	4.9	1.70	4.9	1.52	-	-	-	-	-	-
	-15	-	-	6.1	2.15	6.1	1.95	6.1	1.74	-	-	-	-	-	-
	-10	7.3	2.94	7.3	2.41	7.3	2.19	7.3	1.97	7.6	1.79	7.9	1.62	-	-
	-7	8.0	3.42	8.0	2.57	8.0	2.34	8.0	2.10	8.0	1.92	8.0	1.73	-	-
	2	8.5	3.61	8.5	3.17	8.5	2.89	8.5	2.61	8.5	2.34	8.4	2.06	8.4	1.82
	7	9.0	5.33	9.0	4.19	9.0	3.72	9.0	3.24	9.0	2.88	9.0	2.51	9.0	2.23
	12	9.0	5.69	9.1	4.74	9.2	4.17	9.4	3.59	9.2	3.17	9.1	2.76	9.1	2.37
	15	9.1	6.12	9.1	5.08	9.3	4.44	9.6	3.80	9.4	3.35	9.2	2.90	9.2	2.46
20	9.1	6.86	9.2	5.63	9.5	4.89	9.9	4.15	9.6	3.65	9.4	3.15	9.4	2.60	
Nominal	-20	-	-	4.9	1.89	4.9	1.70	4.9	1.52	-	-	-	-	-	-
	-15	-	-	6.1	2.15	6.1	1.95	6.1	1.74	-	-	-	-	-	-
	-10	7.3	2.94	7.3	2.41	7.3	2.19	7.3	1.97	7.6	1.79	7.9	1.62	-	-
	-7	8.0	3.42	8.0	2.57	8.0	2.34	8.0	2.10	8.0	1.92	8.0	1.73	-	-
	2	8.5	3.61	8.5	3.17	8.5	2.89	8.5	2.61	8.5	2.34	8.4	2.06	8.4	1.82
	7	9.0	5.33	9.0	4.19	9.0	3.72	9.0	3.24	9.0	2.88	9.0	2.51	9.0	2.23
	12	9.0	5.69	9.1	4.74	9.2	4.17	9.4	3.59	9.2	3.17	9.1	2.76	9.1	2.37
	15	9.1	6.12	9.1	5.08	9.3	4.44	9.6	3.80	9.4	3.35	9.2	2.90	9.2	2.46
20	9.1	6.86	9.2	5.63	9.5	4.89	9.9	4.15	9.6	3.65	9.4	3.15	9.4	2.60	
Mid	-20	-	-	5.3	2.29	5.1	2.03	4.9	1.78	-	-	-	-	-	-
	-15	-	-	5.7	2.55	5.5	2.30	5.4	2.04	-	-	-	-	-	-
	-10	6.2	3.15	6.0	2.81	6.0	2.56	5.9	2.30	6.2	2.12	6.5	1.94	-	-
	-7	6.3	3.54	6.2	2.97	6.2	2.72	6.2	2.46	6.2	2.25	6.3	2.04	-	-
	2	5.6	4.27	5.6	3.90	5.6	3.50	5.6	3.10	5.5	2.72	5.4	2.34	5.4	2.09
	7	6.3	5.58	5.8	4.66	5.6	4.11	5.4	3.56	5.5	3.12	5.5	2.68	5.6	2.34
	12	6.3	6.58	6.0	5.39	5.9	4.70	5.8	4.00	5.8	3.49	5.9	2.99	5.9	2.63
	15	6.4	7.26	6.1	5.84	6.1	5.05	6.0	4.26	6.0	3.72	6.1	3.17	6.1	2.81
20	6.4	8.01	6.3	6.57	6.4	5.64	6.4	4.70	6.4	4.09	6.4	3.48	6.4	3.10	
Min	-20	-	-	5.3	2.29	5.1	2.03	4.9	1.78	-	-	-	-	-	-
	-15	-	-	5.7	2.55	5.5	2.30	5.4	2.04	-	-	-	-	-	-
	-10	6.2	3.15	6.0	2.81	6.0	2.56	5.9	2.30	6.2	2.12	6.5	1.94	-	-
	-7	3.4	3.51	3.3	3.00	3.5	2.75	3.7	2.49	3.8	2.26	3.8	2.02	-	-
	2	3.4	4.69	3.3	4.01	3.3	3.44	3.2	2.86	3.2	2.52	3.2	2.18	-	-
	7	4.1	5.76	3.9	4.80	3.9	4.17	3.8	3.53	3.8	3.06	3.8	2.58	-	-
	12	4.7	7.02	4.5	5.65	4.5	4.85	4.4	4.06	4.4	3.50	4.5	2.94	-	-
	15	5.0	7.70	4.9	6.16	4.8	5.27	4.8	4.37	4.8	3.77	4.9	3.16	-	-
20	5.6	8.66	5.5	7.01	5.4	5.96	5.3	4.90	5.5	4.21	5.6	3.52	-	-	

■ PUHZ-W112VHA(-BS)

Water outlet temperature [°C]		25		35		40		45		50		55		60	
Ambient temperature [°C]		Capacity	COP	Capacity	COP	Capacity	COP	Capacity	COP	Capacity	COP	Capacity	COP	Capacity	COP
Max	-20	-	-	6.8	1.79	6.8	1.64	6.8	1.49	-	-	-	-	-	-
	-15	-	-	8.4	2.16	8.4	1.93	8.4	1.69	8.4	1.52	7.8	1.32	-	-
	-10	9.9	2.97	9.9	2.50	9.9	2.25	9.9	1.98	9.9	1.76	9.9	1.52	-	-
	-7	10.9	3.27	10.9	2.73	10.9	2.33	10.9	2.14	10.9	1.78	10.9	1.54	-	-
	2	11.2	3.64	11.2	3.34	11.2	2.93	11.2	2.60	11.2	2.29	11.2	1.97	11.2	1.62
	7	11.2	4.89	11.2	4.47	11.2	3.94	11.2	3.45	11.2	3.02	11.2	2.60	11.2	2.13
	12	11.2	5.78	11.2	5.35	11.2	4.67	11.2	4.00	11.2	3.56	11.2	3.10	11.2	2.58
	15	11.2	6.20	11.2	5.73	11.2	5.04	11.2	4.35	11.2	3.87	11.2	3.34	11.2	2.79
20	11.2	6.87	11.2	6.42	11.2	5.58	11.2	4.73	11.2	4.26	11.2	3.76	11.2	3.20	
Nominal	-20	-	-	6.8	1.79	6.8	1.64	6.8	1.49	-	-	-	-	-	-
	-15	-	-	8.4	2.16	8.4	1.93	8.4	1.69	8.4	1.52	7.8	1.32	-	-
	-10	9.9	2.97	9.9	2.50	9.9	2.25	9.9	1.98	9.9	1.76	9.9	1.52	-	-
	-7	10.9	3.27	10.9	2.73	10.9	2.33	10.9	2.14	10.9	1.78	10.9	1.54	-	-
	2	11.2	3.64	11.2	3.34	11.2	2.93	11.2	2.60	11.2	2.29	11.2	1.97	11.2	1.62
	7	11.2	4.89	11.2	4.47	11.2	3.94	11.2	3.45	11.2	3.02	11.2	2.60	11.2	2.13
	12	11.2	5.78	11.2	5.35	11.2	4.67	11.2	4.00	11.2	3.56	11.2	3.10	11.2	2.58
	15	11.2	6.20	11.2	5.73	11.2	5.04	11.2	4.35	11.2	3.87	11.2	3.34	11.2	2.79
20	11.2	6.87	11.2	6.42	11.2	5.58	11.2	4.73	11.2	4.26	11.2	3.76	11.2	3.20	
Mid	-20	-	-	5.4	1.90	5.4	1.68	5.4	1.49	-	-	-	-	-	-
	-15	-	-	6.7	2.26	6.7	1.98	6.7	1.71	6.7	1.53	6.2	1.36	-	-
	-10	7.9	3.15	7.9	2.59	7.9	2.31	7.9	2.02	7.9	1.79	7.9	1.55	-	-
	-7	8.7	3.41	8.7	2.81	8.7	2.39	8.7	2.19	8.7	1.82	8.7	1.57	-	-
	2	9.0	3.71	9.0	3.69	9.0	3.15	9.0	2.89	9.0	2.46	9.0	2.12	9.0	1.73
	7	9.0	4.95	9.0	4.69	9.0	4.00	9.0	3.59	9.0	3.08	9.0	2.65	9.0	2.17
	12	9.0	5.86	9.0	5.42	9.0	4.74	9.0	4.07	9.0	3.62	9.0	3.15	9.0	2.63
	15	9.0	6.29	9.0	5.80	9.0	5.11	9.0	4.41	9.0	3.93	9.0	3.40	9.0	2.84
20	9.0	6.98	9.0	6.50	9.0	5.65	9.0	4.79	9.0	4.31	9.0	3.81	9.0	3.25	
Min	-20	-	-	3.3	1.97	3.0	1.66	2.7	1.41	-	-	-	-	-	-
	-15	-	-	4.0	2.30	3.7	1.97	3.5	1.66	3.3	1.48	3.0	1.31	-	-
	-10	5.1	3.24	4.6	2.60	4.4	2.30	4.2	1.99	4.0	1.76	3.9	1.54	-	-
	-7	5.6	3.43	5.2	2.80	5.0	2.36	4.8	2.16	4.6	1.80	4.5	1.56	-	-
	2	4.2	4.02	4.1	3.83	3.9	3.28	3.9	3.02	3.7	2.59	3.5	2.23	3.3	1.82
	7	5.1	4.80	4.7	4.58	4.5	3.93	4.4	3.54	4.2	3.04	4.0	2.62	3.7	2.15
	12	5.3	5.68	4.9	5.29	4.7	4.64	4.6	3.99	4.4	3.57	4.2	3.11	3.9	2.60
	15	5.9	6.08	5.4	5.63	5.2	4.97	5.0	4.30	4.8	3.84	4.5	3.33	4.2	2.80
20	7.1	6.71	6.3	6.27	6.0	5.45	5.8	4.63	5.4	4.18	5.1	3.71	4.7	3.18	

Outdoor unit

■ PUAZ-W85V/YAA

Water outlet temperature [°C]		25		35		40		45		50		55		60	
Ambient temperature [°C]		Capacity	COP	Capacity	COP	Capacity	COP	Capacity	COP	Capacity	COP	Capacity	COP	Capacity	COP
Max	-20	-	-	4.6	1.9	4.5	1.66	4.5	1.46	-	-	-	-	-	-
	-15	-	-	6.7	2.28	6.6	2.02	6.5	1.78	-	-	-	-	-	-
	-10	8.1	3.01	7.8	2.37	7.7	2.10	7.6	1.86	7.5	1.83	7.3	1.61	-	-
	-7	8.5	3.11	8.3	2.45	8.2	2.17	8.1	2.09	7.9	1.98	7.8	1.84	-	-
	2	9.8	3.56	9.7	3.08	9.6	2.81	9.5	2.61	9.3	2.37	9.2	2.16	9.0	1.96
	7	10.9	5.52	10.5	4.35	10.1	3.84	9.8	3.40	9.6	3.00	9.4	2.65	9.2	2.36
	12	11.0	5.31	10.7	4.37	10.5	3.91	10.2	3.50	10.1	3.12	9.9	2.79	9.7	2.51
	15	11.9	5.33	11.5	4.63	11.3	4.16	11.1	3.73	10.9	3.33	10.7	2.98	10.5	2.68
20	13.3	5.37	12.9	5.05	12.7	4.55	12.4	3.98	12.3	3.60	12.1	3.26	12.0	2.95	
Nominal	-20	-	-	4.6	1.90	4.5	1.66	4.5	1.46	-	-	-	-	-	-
	-15	-	-	6.1	2.31	6.1	2.04	6.1	1.80	-	-	-	-	-	-
	-10	6.6	3.22	6.6	2.43	6.6	2.12	6.6	2.02	6.6	1.91	6.6	1.63	-	-
	-7	7.5	3.56	7.5	2.69	7.5	2.34	7.5	2.18	7.5	2.02	7.5	1.86	-	-
	2	8.5	4.16	8.5	3.36	8.5	3.01	8.5	2.74	8.5	2.46	8.5	2.21	8.3	1.99
	7	9.0	6.02	9.0	4.51	9.0	3.96	9.0	3.41	9.0	3.03	9.0	2.78	9.0	2.36
	12	9.0	6.60	9.0	4.89	9.0	4.24	9.0	3.69	9.0	3.24	9.0	2.87	9.0	2.56
	15	9.0	7.40	9.0	5.62	9.0	4.79	9.0	4.12	9.0	3.59	9.0	3.15	9.0	2.79
20	9.0	7.87	9.0	7.01	9.0	5.88	9.0	5.00	9.0	4.31	9.0	3.74	9.0	3.27	
Mid	-20	-	-	3.7	1.96	3.6	1.71	3.6	1.50	-	-	-	-	-	-
	-15	-	-	4.9	2.37	4.9	2.09	4.9	1.84	-	-	-	-	-	-
	-10	5.3	3.28	5.3	2.43	5.3	2.19	5.3	2.10	5.3	1.96	5.3	1.61	-	-
	-7	6.0	3.63	6.0	2.74	6.0	2.43	6.0	2.27	6.0	2.09	6.0	1.89	-	-
	2	6.8	4.58	6.8	3.60	6.8	3.19	6.8	2.88	6.8	2.56	6.8	2.24	6.8	2.04
	7	7.2	6.38	7.2	4.72	7.2	4.07	7.2	3.54	7.2	3.08	7.2	2.81	7.2	2.39
	12	7.2	7.35	7.2	5.27	7.2	4.51	7.2	3.89	7.2	3.39	7.2	2.97	7.2	2.63
	15	7.2	8.10	7.2	6.01	7.2	5.08	7.2	4.34	7.2	3.74	7.2	3.26	7.2	2.87
20	7.2	8.75	7.2	7.45	7.2	6.18	7.2	5.23	7.2	4.47	7.2	3.86	7.2	3.36	
Min	-20	-	-	2.9	2.01	2.8	1.76	2.8	1.54	-	-	-	-	-	-
	-15	-	-	3.3	2.03	3.2	1.79	3.2	1.56	-	-	-	-	-	-
	-10	3.7	2.53	3.6	2.36	3.6	2.23	3.5	2.08	3.4	1.89	3.4	1.47	-	-
	-7	3.3	3.20	3.2	2.67	3.2	2.42	3.2	2.10	3.0	1.91	2.8	1.67	-	-
	2	3.8	5.26	3.4	3.99	3.4	3.51	3.2	3.06	3.1	2.67	2.9	2.34	2.8	2.05
	7	3.5	6.38	2.9	4.91	2.8	4.15	2.7	3.53	2.5	3.03	2.4	2.63	2.4	2.31
	12	3.2	8.40	2.9	5.73	2.7	4.81	2.6	4.09	2.5	3.50	2.4	3.03	2.3	2.63
	15	3.4	8.81	3.1	6.36	3.0	5.32	2.9	4.51	2.8	3.85	2.7	3.31	2.5	2.86
20	3.9	9.26	3.6	7.92	3.4	6.45	3.3	5.34	3.2	4.51	3.0	3.84	2.9	3.30	

■ PUAZ-W112V/YAA

Water outlet temperature [°C]		25		35		40		45		50		55		60	
Ambient temperature [°C]		Capacity	COP	Capacity	COP	Capacity	COP	Capacity	COP	Capacity	COP	Capacity	COP	Capacity	COP
Max	-20	-	-	7.0	2.6	6.6	2.21	6.5	1.96	-	-	-	-	-	-
	-15	-	-	7.6	2.78	7.3	2.41	7.0	2.08	-	-	-	-	-	-
	-10	11.0	3.8	10.1	2.87	9.7	2.51	9.4	2.20	9.1	1.94	9.0	1.54	-	-
	-7	11.3	4.09	10.4	3.14	10.0	2.75	9.6	2.41	9.3	2.11	9.0	1.84	-	-
	2	13.1	3.85	12.5	3.08	12.2	2.73	11.9	2.42	11.6	2.14	11.3	1.87	10.9	1.65
	7	14.3	5.47	13.5	4.41	13.1	3.87	12.7	3.22	12.2	2.80	11.7	2.43	11.2	2.20
	12	14.4	6.06	13.7	5.11	13.3	4.59	13.0	4.08	12.6	3.59	12.1	3.13	11.7	2.72
	15	15.5	5.71	14.8	5.23	14.5	4.79	14.1	4.32	13.6	3.85	13.2	3.39	12.6	2.97
20	17.3	7.21	16.9	6.76	16.5	5.68	16.1	4.80	15.6	4.05	15.1	3.65	14.4	3.27	
Nominal	-20	-	-	6.6	2.61	6.6	2.21	6.5	1.96	-	-	-	-	-	-
	-15	-	-	7.0	2.79	7.0	2.42	7.0	2.08	-	-	-	-	-	-
	-10	9.0	4.04	9.0	3.00	9.0	2.59	9.0	2.24	9.0	1.95	9.0	1.54	-	-
	-7	9.0	4.36	9.0	3.27	9.0	2.83	9.0	2.46	9.0	2.13	9.0	1.84	-	-
	2	11.2	4.47	11.2	3.34	11.2	2.94	11.2	2.66	11.2	2.19	11.2	1.89	10.8	1.66
	7	11.2	5.85	11.2	4.54	11.2	3.94	11.2	3.32	11.2	2.94	11.2	2.70	11.2	2.20
	12	11.2	7.59	11.2	5.87	11.2	5.10	11.2	4.36	11.2	3.76	11.2	3.22	11.2	2.76
	15	11.2	8.33	11.2	6.66	11.2	5.75	11.2	4.95	11.2	4.25	11.2	3.61	11.2	3.09
20	11.2	8.94	11.2	8.39	11.2	7.04	11.2	5.96	11.2	5.02	11.2	4.28	11.2	3.64	
Mid	-20	-	-	5.3	2.55	5.3	2.17	5.3	1.91	-	-	-	-	-	-
	-15	-	-	5.6	2.75	5.6	2.39	5.6	2.06	-	-	-	-	-	-
	-10	7.2	4.07	7.2	3.08	7.2	2.67	7.2	2.32	7.2	2.02	7.2	1.72	-	-
	-7	7.2	4.36	7.2	3.33	7.2	2.89	7.2	2.51	7.2	2.19	7.2	1.88	-	-
	2	9.0	4.75	9.0	3.68	9.0	3.20	9.0	2.76	9.0	2.38	9.0	2.06	9.0	1.77
	7	9.0	5.86	9.0	4.64	9.0	4.04	9.0	3.50	9.0	3.02	9.0	2.71	9.0	2.20
	12	9.0	7.94	9.0	6.09	9.0	5.29	9.0	4.54	9.0	3.91	9.0	3.35	9.0	2.89
	15	9.0	8.73	9.0	6.86	9.0	5.89	9.0	5.06	9.0	4.34	9.0	3.70	9.0	3.16
20	9.0	9.37	9.0	8.51	9.0	7.13	9.0	5.99	9.0	5.07	9.0	4.32	9.0	3.70	
Min	-20	-	-	4.9	2.51	4.6	2.12	4.4	1.85	-	-	-	-	-	-
	-15	-	-	5.5	2.74	5.2	2.36	4.9	2.02	-	-	-	-	-	-
	-10	6.9	4.07	6.2	3.07	5.9	2.66	5.7	2.29	5.4	1.98	5.1	1.73	-	-
	-7	4.3	4.03	3.9	3.14	3.7	2.70	3.4	2.30	3.2	1.92	3.0	1.70	-	-
	2	4.6	4.75	4.2	3.69	4.0	3.20	3.7	2.75	3.5	2.40	3.2	2.07	3.0	1.70
	7	3.7	5.41	3.3	4.31	3.1	3.72	2.9	3.18	2.8	2.82	2.5	2.35	2.3	1.89
	12	4.3	7.59	4.0	5.74	3.8	4.93	3.7	4.47	3.5	3.81	3.3	3.37	3.1	2.86
	15	4.8	8.50	4.4	6.41	4.2	5.43	4.0	4.59	3.7	3.89	3.5	3.46	3.3	2.94
20	5.7	9.22	5.1	7.89	4.8	6.39	4.6	5.28	4.3	4.58	4.1	3.88	3.9	3.44	

■ PUAZ-HW112YHA2(-BS)

Water outlet temperature[°C]		25		35		40		45		50		55		60	
Ambient temperature[°C]		Capacity	COP	Capacity	COP	Capacity	COP	Capacity	COP	Capacity	COP	Capacity	COP	Capacity	COP
Max	(INJ) -20	-	-	9.3	1.60	9.3	1.51	9.3	1.41	-	-	-	-	-	-
	(INJ) -15	-	-	10.0	1.96	10.0	1.82	10.0	1.67	10.0	1.51	10.0	1.34	-	-
	(INJ) -10	10.8	2.72	10.8	2.32	10.8	2.12	10.8	1.93	10.8	1.72	10.8	1.52	-	-
	(INJ) -7	11.2	2.99	11.2	2.53	11.2	2.31	11.2	2.09	11.2	1.86	11.2	1.62	-	-
	(INJ) 2	11.2	3.50	11.2	3.11	11.2	2.86	11.2	2.61	11.2	2.35	11.2	2.08	11.2	1.86
	7	11.2	4.75	11.2	4.43	11.2	3.91	11.2	3.39	11.2	2.94	11.2	2.48	11.2	2.14
	12	11.2	5.46	11.2	4.61	11.2	4.08	11.2	3.54	11.2	3.06	11.2	2.59	11.2	2.22
	15	11.2	5.65	11.2	4.73	11.2	4.17	11.2	3.62	11.2	3.14	11.2	2.65	11.2	2.26
20	11.2	5.80	11.2	4.91	11.2	4.34	11.2	3.77	11.2	3.27	11.2	2.76	11.2	2.34	
Nominal	(INJ) -20	-	-	9.3	1.60	9.3	1.51	9.3	1.41	-	-	-	-	-	-
	(INJ) -15	-	-	10.0	1.96	10.0	1.82	10.0	1.67	10.0	1.51	10.0	1.34	-	-
	(INJ) -10	10.8	2.72	10.8	2.32	10.8	2.12	10.8	1.93	10.8	1.72	10.8	1.52	-	-
	(INJ) -7	11.2	2.99	11.2	2.53	11.2	2.31	11.2	2.09	11.2	1.86	11.2	1.62	-	-
	(INJ) 2	11.2	3.50	11.2	3.11	11.2	2.86	11.2	2.61	11.2	2.35	11.2	2.08	11.2	1.86
	7	11.2	4.75	11.2	4.43	11.2	3.91	11.2	3.39	11.2	2.94	11.2	2.48	11.2	2.14
	12	11.2	5.46	11.2	4.61	11.2	4.08	11.2	3.54	11.2	3.06	11.2	2.59	11.2	2.22
	15	11.2	5.65	11.2	4.73	11.2	4.17	11.2	3.62	11.2	3.14	11.2	2.65	11.2	2.26
20	11.2	5.80	11.2	4.91	11.2	4.34	11.2	3.77	11.2	3.27	11.2	2.76	11.2	2.34	
Mid	(INJ) -20	-	-	8.5	1.92	8.7	1.78	8.9	1.64	-	-	-	-	-	-
	(INJ) -15	-	-	8.1	2.27	8.2	2.06	8.2	1.85	8.5	1.72	8.9	1.58	-	-
	(INJ) -10	7.7	2.98	7.7	2.62	7.6	2.34	7.5	2.06	8.2	1.92	8.9	1.77	-	-
	(INJ) -7	7.7	3.43	7.5	2.83	7.2	2.51	7.0	2.19	8.0	2.04	9.0	1.89	-	-
	2	7.7	4.26	7.5	4.22	7.3	3.67	7.1	3.11	7.2	2.69	7.4	2.27	7.3	1.89
	7	7.9	4.97	7.6	4.48	7.5	4.08	7.4	3.67	7.5	3.19	7.6	2.71	7.5	2.38
	12	7.9	5.67	7.6	4.81	7.5	4.33	7.4	3.84	7.5	3.34	7.6	2.84	7.5	2.42
	15	7.9	5.90	7.6	5.02	7.5	4.48	7.4	3.94	7.5	3.43	7.6	2.92	7.5	2.44
20	7.9	6.26	7.6	5.35	7.5	4.73	7.4	4.11	7.6	3.58	7.7	3.05	7.6	2.48	
Min	-20	-	-	8.5	1.92	8.7	1.78	8.9	1.64	-	-	-	-	-	-
	-15	-	-	8.1	2.27	8.2	2.06	8.2	1.85	8.5	1.72	8.9	1.58	-	-
	-10	7.7	2.98	7.7	2.62	7.6	2.34	7.5	2.06	8.2	1.92	8.9	1.77	-	-
	-7	4.0	3.49	3.2	2.45	2.9	2.01	2.6	1.57	2.4	1.34	2.2	1.10	-	-
	2	4.3	4.47	3.9	3.86	3.7	3.25	3.5	2.64	3.3	2.17	3.2	1.69	-	-
	7	4.8	5.11	4.6	4.58	4.5	3.97	4.4	3.35	4.4	2.83	4.4	2.30	-	-
	12	4.8	5.92	4.6	4.78	4.5	4.14	4.4	3.51	4.4	2.96	4.4	2.41	-	-
	15	4.8	6.12	4.6	4.89	4.5	4.25	4.5	3.60	4.4	3.04	4.4	2.47	-	-
20	4.8	6.42	4.6	5.09	4.6	4.43	4.5	3.76	4.5	3.17	4.4	2.58	-	-	

■ PUAZ-HW140V/YHA2(-BS)

Water outlet temperature[°C]		25		35		40		45		50		55		60	
Ambient temperature[°C]		Capacity	COP	Capacity	COP	Capacity	COP	Capacity	COP	Capacity	COP	Capacity	COP	Capacity	COP
Max	(INJ) -20	-	-	9.1	1.51	9.1	1.37	9.1	1.23	-	-	-	-	-	-
	(INJ) -15	-	-	11.0	1.96	11.0	1.78	11.0	1.60	11.0	1.58	11.0	1.55	-	-
	(INJ) -10	12.9	2.59	12.9	2.41	12.9	2.19	12.9	1.97	12.9	1.84	12.9	1.71	-	-
	(INJ) -7	14.0	2.78	14.0	2.68	14.0	2.44	14.0	2.19	14.0	2.00	14.0	1.80	-	-
	(INJ) 2	14.0	2.99	14.0	3.11	14.0	2.86	14.0	2.61	14.0	2.38	14.0	2.14	14.0	1.89
	7	14.0	4.54	14.0	4.26	14.0	3.81	14.0	3.35	14.0	3.03	14.0	2.70	14.0	2.45
	12	14.0	5.18	14.0	4.51	14.0	4.03	14.0	3.56	14.0	3.21	14.0	2.87	14.0	2.56
	15	14.0	5.35	14.0	4.66	14.0	4.17	14.0	3.68	14.0	3.32	14.0	2.96	14.0	2.63
20	14.0	5.57	14.0	4.91	14.0	4.40	14.0	3.89	14.0	3.51	14.0	3.13	14.0	2.74	
Nominal	(INJ) -20	-	-	9.1	1.51	9.1	1.37	9.1	1.23	-	-	-	-	-	-
	(INJ) -15	-	-	11.0	1.96	11.0	1.78	11.0	1.60	11.0	1.58	11.0	1.55	-	-
	(INJ) -10	12.9	2.59	12.9	2.41	12.9	2.19	12.9	1.97	12.9	1.84	12.9	1.71	-	-
	(INJ) -7	14.0	2.78	14.0	2.68	14.0	2.44	14.0	2.19	14.0	2.00	14.0	1.80	-	-
	(INJ) 2	14.0	2.99	14.0	3.11	14.0	2.86	14.0	2.61	14.0	2.38	14.0	2.14	14.0	1.89
	7	14.0	4.54	14.0	4.26	14.0	3.81	14.0	3.35	14.0	3.03	14.0	2.70	14.0	2.45
	12	14.0	5.18	14.0	4.51	14.0	4.03	14.0	3.56	14.0	3.21	14.0	2.87	14.0	2.56
	15	14.0	5.35	14.0	4.66	14.0	4.17	14.0	3.68	14.0	3.32	14.0	2.96	14.0	2.63
20	14.0	5.57	14.0	4.91	14.0	4.40	14.0	3.89	14.0	3.51	14.0	3.13	14.0	2.74	
Mid	(INJ) -20	-	-	10.0	2.50	10.2	2.13	10.3	1.75	-	-	-	-	-	-
	(INJ) -15	-	-	9.9	2.46	9.9	2.23	9.9	1.99	10.1	1.81	10.4	1.63	-	-
	(INJ) -10	9.5	2.87	9.8	2.42	9.6	2.33	9.5	2.23	10.1	2.03	10.7	1.82	-	-
	(INJ) -7	9.6	3.23	9.7	2.40	9.5	2.39	9.3	2.37	10.1	2.16	10.9	1.94	-	-
	2	9.6	3.77	8.8	3.26	9.1	3.01	9.3	2.75	9.3	2.51	9.2	2.26	9.1	2.05
	7	9.7	4.89	9.0	4.24	8.9	3.75	8.8	3.25	8.8	2.96	8.8	2.67	8.9	2.46
	12	9.7	5.49	9.1	4.52	8.9	4.11	8.7	3.70	8.9	3.48	9.0	3.26	8.9	2.57
	15	9.7	5.72	9.1	4.69	8.9	4.33	8.6	3.98	8.9	3.79	9.2	3.61	9.0	2.63
20	9.7	6.17	9.2	4.97	8.9	4.70	8.5	4.43	9.0	4.32	9.4	4.20	9.0	2.74	
Min	-20	-	-	10.0	2.50	10.2	2.13	10.3	1.75	-	-	-	-	-	-
	-15	-	-	9.9	2.46	9.9	2.23	9.9	1.99	10.1	1.81	10.4	1.63	-	-
	-10	9.5	2.87	9.8	2.42	9.6	2.33	9.5	2.23	10.1	2.03	10.7	1.82	-	-
	-7	5.5	3.42	3.6	1.98	3.9	2.02	4.2	2.06	3.8	1.68	3.3	1.30	-	-
	2	5.9	4.34	4.3	2.71	4.3	2.46	4.4	2.20	3.7	1.79	3.1	1.37	-	-
	7	6.3	5.03	5.9	3.95	5.6	3.41	5.3	2.87	4.9	2.44	4.5	2.00	-	-
	12	6.8	5.69	6.2	4.30	5.8	3.89	5.4	3.47	5.2	2.99	4.9	2.52	-	-
	15	7.2	5.91	6.4	4.51	5.9	4.17	5.4	3.83	5.3	3.33	5.2	2.83	-	-
20	7.8	6.29	6.7	4.86	6.1	4.65	5.4	4.43	5.5	3.89	5.6	3.35	-	-	

(2) Split-type units

■ SUHZ-SW45VA

Water outlet temperature[°C]	25		35		40		45		50		55		60	
	Capacity	COP	Capacity	COP	Capacity	COP	Capacity	COP	Capacity	COP	Capacity	COP	Capacity	COP
Max	Ambient temperature[°C]													
-20	-	-	-	-	-	-	-	-	-	-	-	-	-	-
-15	3.7	2.76	3.4	2.35	3.3	1.83	3.1	1.74	-	-	-	-	-	-
-10	4.4	3.24	4.0	2.43	3.9	2.13	3.7	1.88	3.5	1.66	-	-	-	-
-7	4.7	3.40	4.4	2.64	4.2	2.30	4.0	2.02	3.7	1.70	3.5	1.41	-	-
2	4.7	3.45	4.5	2.84	4.4	2.53	4.3	2.22	4.2	1.91	4.0	1.60	-	-
7	7.7	4.70	7.0	3.99	6.6	3.45	6.3	2.91	6.3	2.59	6.3	2.27	-	-
12	9.0	5.80	7.8	4.44	7.2	3.76	6.7	3.08	6.6	2.76	6.5	2.45	-	-
15	9.4	6.13	8.3	4.72	7.7	4.01	7.2	3.31	7.1	2.98	6.9	2.65	-	-
20	9.6	6.40	9.1	5.18	8.9	4.57	8.6	3.95	8.4	3.58	8.2	3.20	-	-
Nominal	Ambient temperature[°C]													
-20	-	-	-	-	-	-	-	-	-	-	-	-	-	-
-15	3.2	2.31	3.0	1.89	2.9	1.69	2.8	1.48	-	-	-	-	-	-
-10	3.6	2.95	3.5	2.40	3.5	2.13	3.4	1.86	3.4	1.58	-	-	-	-
-7	3.8	3.17	3.8	2.71	3.8	2.40	3.8	2.08	3.7	1.74	3.5	1.41	-	-
2	3.5	4.00	3.5	3.40	3.5	3.10	3.5	2.80	3.5	2.42	3.5	2.04	-	-
7	4.5	6.42	4.5	5.06	4.5	4.38	4.5	3.70	4.5	3.20	4.5	2.70	-	-
12	5.1	7.45	5.1	5.84	5.1	5.03	5.1	4.22	5.1	3.60	5.1	2.99	-	-
15	5.4	8.07	5.4	6.30	5.4	5.42	5.4	4.54	5.4	3.85	5.4	3.16	-	-
20	6.0	8.19	6.0	7.08	6.0	6.07	6.0	5.06	6.0	4.25	6.0	3.45	-	-
Mid	Ambient temperature[°C]													
-20	-	-	-	-	-	-	-	-	-	-	-	-	-	-
-15	2.6	3.01	2.4	2.05	2.3	1.71	2.2	1.13	-	-	-	-	-	-
-10	2.9	3.31	2.8	2.50	2.8	2.28	2.7	1.79	2.7	1.29	-	-	-	-
-7	3.0	3.50	3.0	2.77	3.0	2.37	3.0	2.01	2.9	1.76	2.8	1.34	-	-
2	2.8	4.09	2.8	3.35	2.8	2.98	2.8	2.61	2.8	2.21	2.8	1.80	-	-
7	3.6	6.16	3.6	4.81	3.6	4.13	3.6	3.46	3.6	2.90	3.6	2.35	-	-
12	4.1	7.67	4.1	5.88	4.0	4.98	4.1	4.09	4.1	3.41	4.1	2.74	-	-
15	4.3	8.15	4.3	6.52	4.3	5.49	4.3	4.47	4.3	3.72	4.3	2.98	-	-
20	4.8	8.57	4.8	7.59	4.8	6.34	4.8	5.10	4.8	4.23	4.8	3.37	-	-
Min	Ambient temperature[°C]													
-20	-	-	-	-	-	-	-	-	-	-	-	-	-	-
-15	2.1	2.15	1.8	1.62	1.7	1.35	1.5	1.08	-	-	-	-	-	-
-10	2.5	2.74	2.3	2.12	2.1	1.81	2.0	1.50	1.8	1.19	-	-	-	-
-7	3.1	3.42	2.8	2.68	2.7	2.30	2.5	1.83	2.1	1.55	1.7	1.16	-	-
2	3.1	3.91	2.7	3.31	2.5	2.80	2.4	2.17	2.2	1.81	2.1	1.34	-	-
7	3.2	5.49	3.0	4.28	2.9	3.68	2.8	2.92	2.5	2.37	2.2	1.67	-	-
12	2.6	7.17	2.2	4.96	2.2	3.80	2.2	3.32	2.1	2.96	2.0	2.42	-	-
15	2.6	7.52	2.5	5.25	2.5	4.57	2.4	3.59	2.3	3.28	2.1	2.57	-	-
20	3.2	8.68	3.0	6.97	2.9	5.86	2.8	4.34	2.6	3.82	2.3	2.82	-	-

■ SUHZ-SW45VAH

Water outlet temperature[°C]	25		35		40		45		50		55		60	
	Capacity	COP	Capacity	COP	Capacity	COP	Capacity	COP	Capacity	COP	Capacity	COP	Capacity	COP
Max	Ambient temperature[°C]													
-20	-	-	-	-	-	-	-	-	-	-	-	-	-	-
-15	3.7	2.53	3.4	2.17	3.3	1.71	3.1	1.63	-	-	-	-	-	-
-10	4.4	2.98	4.0	2.27	3.9	2.00	3.7	1.77	3.5	1.57	-	-	-	-
-7	4.7	3.13	4.4	2.46	4.2	2.16	4.0	1.91	3.7	1.61	3.5	1.34	-	-
2	4.7	3.17	4.5	2.64	4.4	2.37	4.3	2.09	4.2	1.81	4.0	1.53	-	-
7	7.7	4.70	7.0	3.99	6.6	3.45	6.3	2.91	6.3	2.59	6.3	2.27	-	-
12	9.0	5.80	7.8	4.44	7.2	3.76	6.7	3.08	6.6	2.76	6.5	2.45	-	-
15	9.4	6.13	8.3	4.72	7.7	4.01	7.2	3.31	7.1	2.98	6.9	2.65	-	-
20	9.6	6.40	9.1	5.18	8.9	4.57	8.6	3.95	8.4	3.58	8.2	3.20	-	-
Nominal	Ambient temperature[°C]													
-20	-	-	-	-	-	-	-	-	-	-	-	-	-	-
-15	3.2	2.13	3.0	1.76	2.9	1.58	2.8	1.39	-	-	-	-	-	-
-10	3.6	2.68	3.5	2.22	3.5	1.98	3.4	1.75	3.4	1.50	-	-	-	-
-7	3.8	2.88	3.8	2.50	3.8	2.23	3.8	1.95	3.7	1.65	3.5	1.34	-	-
2	3.5	3.52	3.5	3.04	3.5	2.80	3.5	2.55	3.5	2.23	3.5	1.91	-	-
7	4.5	6.42	4.5	5.06	4.5	4.38	4.5	3.70	4.5	3.20	4.5	2.70	-	-
12	5.1	7.45	5.1	5.84	5.1	5.03	5.1	4.22	5.1	3.60	5.1	2.99	-	-
15	5.4	8.07	5.4	6.30	5.4	5.42	5.4	4.54	5.4	3.85	5.4	3.16	-	-
20	6.0	8.19	6.0	7.08	6.0	6.07	6.0	5.06	6.0	4.25	6.0	3.45	-	-
Mid	Ambient temperature[°C]													
-20	-	-	-	-	-	-	-	-	-	-	-	-	-	-
-15	2.6	2.64	2.4	1.86	2.3	1.57	2.2	1.07	-	-	-	-	-	-
-10	2.9	2.91	2.8	2.26	2.8	2.08	2.7	1.66	2.7	1.22	-	-	-	-
-7	3.0	3.08	3.0	2.50	3.0	2.17	3.0	1.86	2.9	1.64	2.8	1.27	-	-
2	2.8	3.48	2.8	2.93	2.8	2.64	2.8	2.35	2.8	2.02	2.8	1.67	-	-
7	3.6	6.16	3.6	4.81	3.6	4.13	3.6	3.46	3.6	2.90	3.6	2.35	-	-
12	4.1	7.67	4.1	5.88	4.1	4.98	4.1	4.09	4.1	3.41	4.1	2.74	-	-
15	4.3	8.15	4.3	6.52	4.3	5.49	4.3	4.47	4.3	3.72	4.3	2.98	-	-
20	4.8	8.57	4.8	7.59	4.8	6.34	4.8	5.10	4.8	4.23	4.8	3.37	-	-
Min	Ambient temperature[°C]													
-20	-	-	-	-	-	-	-	-	-	-	-	-	-	-
-15	2.1	1.91	1.8	1.46	1.7	1.23	1.5	0.99	-	-	-	-	-	-
-10	2.5	2.42	2.3	1.91	2.1	1.64	2.0	1.38	1.8	1.10	-	-	-	-
-7	3.1	3.02	2.8	2.40	2.7	2.08	2.5	1.68	2.1	1.42	1.7	1.07	-	-
2	3.1	3.39	2.7	2.89	2.5	2.47	2.4	1.95	2.2	1.65	2.1	1.24	-	-
7	3.2	5.49	3.0	4.28	2.9	3.68	2.8	2.92	2.5	2.37	2.2	1.67	-	-
12	2.6	7.17	2.2	4.96	2.2	3.80	2.2	3.32	2.1	2.96	2.0	2.42	-	-
15	2.6	7.52	2.5	5.25	2.5	4.57	2.4	3.59	2.3	3.28	2.1	2.57	-	-
20	3.2	8.68	3.0	6.97	2.9	5.86	2.8	4.34	2.6	3.82	2.3	2.82	-	-

■ PUHZ-SW50VKA(-BS)

Water outlet temperature[°C]		25		35		40		45		50		55		60	
Ambient temperature[°C]		Capacity	COP	Capacity	COP	Capacity	COP	Capacity	COP	Capacity	COP	Capacity	COP	Capacity	COP
Max	-20	-	-	-	-	-	-	-	-	-	-	-	-	-	-
	-15	-	-	3.8	2.04	3.4	1.76	3.0	1.48	2.7	1.20	-	-	-	-
	-10	5.6	2.97	4.9	2.42	4.5	2.14	4.1	1.87	4.0	1.69	3.9	1.51	-	-
	-7	6.2	3.20	5.5	2.65	5.1	2.38	4.8	2.10	4.6	1.90	4.5	1.70	-	-
	2	5.7	3.25	5.7	2.83	5.7	2.62	5.6	2.41	5.6	2.19	5.6	1.98	5.6	1.77
	7	8.0	4.72	7.6	3.87	7.4	3.45	7.3	3.02	7.1	2.60	6.9	2.17	6.7	1.75
	12	8.8	5.53	8.6	4.48	8.5	3.95	8.4	3.42	8.2	2.94	8.0	2.46	7.8	1.98
	15	9.3	6.02	9.2	4.84	9.1	4.25	9.1	3.66	8.8	3.14	8.6	2.63	8.4	2.11
20	10.1	6.83	10.2	5.45	10.2	4.75	10.2	4.06	9.9	3.49	9.7	2.92	9.4	2.35	
Nominal	-20	-	-	-	-	-	-	-	-	-	-	-	-	-	-
	-15	-	-	3.8	2.04	3.4	1.76	3.0	1.48	2.7	1.20	-	-	-	-
	-10	5.6	2.97	4.9	2.42	4.5	2.14	4.1	1.87	4.0	1.69	3.9	1.51	-	-
	-7	6.2	3.20	5.5	2.65	5.1	2.38	4.8	2.10	4.6	1.90	4.5	1.70	-	-
	2	5.0	3.47	5.0	2.97	5.0	2.72	5.0	2.47	5.0	2.22	5.0	1.97	5.0	1.72
	7	5.5	5.52	5.5	4.42	5.5	3.87	5.5	3.32	5.5	2.77	5.5	2.22	5.5	1.67
	12	6.4	6.46	6.4	5.18	6.4	4.53	6.4	3.89	6.4	3.24	6.4	2.60	6.4	1.96
	15	7.0	7.03	7.0	5.63	7.0	4.93	7.0	4.23	7.0	3.53	7.0	2.83	7.0	2.13
20	7.9	7.98	7.9	6.39	7.9	5.59	7.9	4.80	7.9	4.00	7.9	3.21	7.9	2.41	
Mid	-20	-	-	-	-	-	-	-	-	-	-	-	-	-	-
	-15	-	-	3.0	2.23	2.7	1.94	2.4	1.65	2.1	1.36	-	-	-	-
	-10	4.5	3.21	3.9	2.65	3.6	2.37	3.3	2.09	3.3	1.84	3.3	1.60	-	-
	-7	5.0	3.45	4.4	2.90	4.1	2.63	3.8	2.35	3.8	2.08	3.8	1.80	-	-
	2	4.0	3.83	4.0	3.25	4.0	2.96	4.0	2.67	4.0	2.37	4.0	2.08	4.0	1.79
	7	4.4	5.75	4.4	4.63	4.4	4.07	4.4	3.51	4.4	2.95	4.4	2.39	4.4	1.83
	12	5.1	6.73	5.1	5.42	5.1	4.77	5.1	4.11	5.1	3.45	5.1	2.80	5.1	2.14
	15	5.6	7.32	5.6	5.90	5.6	5.18	5.6	4.47	5.6	3.76	5.6	3.04	5.6	2.33
20	6.3	8.31	6.3	6.69	6.3	5.88	6.3	5.07	6.3	4.26	6.3	3.45	6.3	2.64	
Min	-20	-	-	-	-	-	-	-	-	-	-	-	-	-	-
	-15	-	-	1.4	1.63	1.3	1.42	1.1	1.21	1.0	1.00	-	-	-	-
	-10	2.3	3.02	2.1	2.50	2.0	2.24	2.0	1.98	1.9	1.74	1.9	1.51	-	-
	-7	2.7	3.60	2.6	3.02	2.5	2.73	2.5	2.44	2.4	2.15	2.3	1.86	-	-
	2	2.3	4.63	2.2	3.84	2.2	3.45	2.1	3.05	2.1	2.66	2.0	2.26	-	-
	7	2.5	5.63	2.4	4.55	2.3	4.01	2.2	3.47	2.2	2.93	2.1	2.39	-	-
	12	2.9	6.59	2.8	5.33	2.7	4.70	2.6	4.06	2.5	3.43	2.4	2.80	-	-
	15	3.2	7.17	3.0	5.80	2.9	5.11	2.8	4.42	2.7	3.73	2.6	3.04	-	-
20	3.6	8.13	3.4	6.57	3.3	5.79	3.2	5.01	3.1	4.23	3.0	3.45	-	-	

■ PUHZ-SW75VHA(-BS)

Water outlet temperature[°C]		25		35		40		45		50		55		60	
Ambient temperature[°C]		Capacity	COP	Capacity	COP	Capacity	COP	Capacity	COP	Capacity	COP	Capacity	COP	Capacity	COP
Max	-20	-	-	5.6	1.78	5.6	1.64	5.6	1.51	-	-	-	-	-	-
	-15	-	-	6.6	2.12	6.5	1.91	6.4	1.72	6.1	1.66	-	-	-	-
	-10	8.6	2.72	8.2	2.35	8.0	2.11	7.8	1.88	7.3	1.72	6.7	1.56	-	-
	-7	9.6	3.07	9.0	2.61	8.6	2.33	8.3	2.05	7.7	1.89	7.0	1.71	-	-
	2	10.4	3.30	9.6	2.84	8.9	2.60	8.3	2.37	7.7	2.15	7.1	1.91	6.6	1.65
	7	10.7	4.53	10.2	3.93	10.0	3.54	9.7	3.14	9.5	2.88	9.3	2.59	9.0	2.26
	12	12.7	5.20	12.0	4.62	11.7	4.11	11.3	3.59	11.0	3.26	10.7	2.90	10.4	2.38
	15	13.9	5.51	13.0	4.96	12.5	4.38	12.0	3.80	11.7	3.43	11.3	3.02	11.0	2.50
20	14.4	5.76	13.5	5.17	13.0	4.56	12.6	3.95	12.2	3.56	11.9	3.15	11.5	2.56	
Nominal	-20	-	-	5.6	1.78	5.6	1.64	5.6	1.51	-	-	-	-	-	-
	-15	-	-	6.6	2.12	6.5	1.91	6.4	1.72	6.1	1.66	-	-	-	-
	-10	7.0	2.91	7.0	2.47	7.0	2.20	7.0	1.92	7.0	1.76	6.7	1.56	-	-
	-7	7.0	3.51	7.0	2.90	7.0	2.55	7.0	2.20	7.0	1.96	7.0	1.71	-	-
	2	7.5	3.97	7.5	3.40	7.5	3.11	7.5	2.83	7.5	2.37	7.1	1.91	6.6	1.65
	7	8.0	5.24	8.0	4.40	8.0	3.90	8.0	3.40	8.0	3.10	8.0	2.77	8.0	2.33
	12	9.0	6.16	9.0	5.26	9.0	4.54	9.0	3.83	9.0	3.42	9.0	2.97	9.0	2.50
	15	9.7	6.63	9.7	5.70	9.7	4.87	9.7	4.04	9.7	3.59	9.7	3.11	9.7	2.58
20	10.2	7.03	10.2	6.03	10.2	5.14	10.2	4.25	10.2	3.76	10.2	3.25	10.2	2.68	
Mid	-20	-	-	4.5	1.68	4.5	1.54	4.5	1.39	-	-	-	-	-	-
	-15	-	-	5.3	2.09	5.2	1.88	5.2	1.67	4.9	1.57	-	-	-	-
	-10	5.6	3.10	5.6	2.60	5.6	2.30	5.6	1.99	5.6	1.80	5.4	1.58	-	-
	-7	5.6	3.54	5.6	2.94	5.6	2.59	5.6	2.24	5.6	2.01	5.6	1.77	-	-
	2	6.0	4.23	6.0	3.55	6.0	3.21	6.0	2.87	6.0	2.54	5.7	2.18	5.3	1.71
	7	6.4	5.59	6.4	4.66	6.4	4.14	6.4	3.62	6.4	3.24	6.4	2.85	6.4	2.41
	12	7.5	6.47	7.2	5.73	7.2	4.89	7.2	4.05	7.2	3.59	7.2	3.09	7.2	2.56
	15	7.9	7.14	7.7	6.16	7.7	5.23	7.7	4.31	7.7	3.79	7.7	3.25	7.7	2.66
20	8.6	8.01	8.1	6.72	8.1	5.66	8.1	4.59	8.1	4.04	8.1	3.45	8.1	2.81	
Min	-20	-	-	4.5	1.68	4.5	1.54	4.5	1.39	-	-	-	-	-	-
	-15	-	-	5.3	2.09	5.2	1.88	5.2	1.67	4.9	1.57	-	-	-	-
	-10	5.6	3.10	5.6	2.60	5.6	2.30	5.6	1.99	5.6	1.80	5.4	1.58	-	-
	-7	5.0	3.44	4.6	2.86	4.4	2.52	4.2	2.18	4.0	1.96	3.8	1.73	-	-
	2	4.9	4.45	4.0	3.66	3.8	3.30	3.6	2.95	3.4	2.61	3.2	2.25	-	-
	7	6.0	5.55	3.8	4.52	3.6	3.98	3.3	3.44	3.1	3.02	2.9	2.56	-	-
	12	7.5	6.47	2.8	5.44	2.6	4.49	2.3	3.53	2.1	3.02	1.9	2.46	-	-
	15	7.9	7.14	3.1	6.06	2.8	4.98	2.5	3.91	2.3	3.33	2.1	2.69	-	-
20	8.6	8.01	6.6	7.08	6.2	5.95	5.8	4.83	5.4	4.22	5.1	3.57	-	-	

5 Performance data

Outdoor unit

Outdoor unit

■ PUHZ-SW100V/YHA(-BS)

Water outlet temperature[°C]		25		35		40		45		50		55		60	
Ambient temperature[°C]		Capacity	COP	Capacity	COP	Capacity	COP	Capacity	COP	Capacity	COP	Capacity	COP	Capacity	COP
Max	-20	-	-	6.9	1.79	6.7	1.64	6.6	1.49	-	-	-	-	-	-
	-15	-	-	8.2	2.16	8.1	1.93	8.0	1.69	7.9	1.52	7.8	1.34	-	-
	-10	9.7	2.97	9.5	2.50	9.4	2.25	9.4	1.98	9.1	1.76	8.9	1.52	-	-
	-7	10.9	3.27	10.6	2.73	10.4	2.45	10.3	2.14	10.0	1.91	9.7	1.62	-	-
	2	12.0	3.56	11.5	3.16	11.2	2.83	11.0	2.49	10.6	2.19	10.1	1.88	9.4	1.49
	7	15.6	4.48	14.8	4.15	14.4	3.70	14.0	3.24	13.4	2.90	12.80	2.54	12.2	2.07
	12	17.7	5.14	16.8	4.72	16.4	4.20	16.0	3.68	15.4	3.30	14.7	2.91	14.0	2.39
	15	18.7	5.53	17.8	4.98	17.3	4.44	16.9	3.89	16.2	3.51	15.6	3.08	14.9	2.58
20	19.8	5.87	19.0	5.31	18.6	4.75	18.1	4.19	17.5	3.78	16.8	3.34	16.2	2.97	
Nominal	-20	-	-	6.9	1.79	6.7	1.64	6.6	1.49	-	-	-	-	-	-
	-15	-	-	8.2	2.16	8.1	1.93	8.0	1.69	7.9	1.52	7.8	1.34	-	-
	-10	8.5	3.02	8.5	2.52	8.5	2.27	8.5	2.02	8.5	1.78	8.5	1.54	-	-
	-7	8.5	3.45	8.5	2.89	8.5	2.55	8.5	2.22	8.5	1.94	8.5	1.65	-	-
	2	10.0	3.86	10.0	3.32	10.0	2.99	10.0	2.66	10.0	2.28	10.0	1.89	9.4	1.49
	7	11.2	4.89	11.2	4.45	11.2	3.94	11.2	3.42	11.2	3.02	11.2	2.60	11.2	2.13
	12	12.9	5.60	12.9	5.16	12.9	4.54	12.9	3.92	12.9	3.48	12.9	2.99	12.9	2.48
	15	13.6	6.00	13.6	5.49	13.6	4.83	13.6	4.18	13.6	3.71	13.6	3.21	13.6	2.65
20	14.7	6.62	14.7	5.96	14.7	5.27	14.7	4.57	14.7	4.06	14.7	3.52	14.7	3.10	
Mid	-20	-	-	5.5	1.81	5.4	1.67	5.2	1.51	-	-	-	-	-	-
	-15	-	-	6.5	2.18	6.5	1.96	6.4	1.71	6.3	1.55	6.2	1.36	-	-
	-10	6.8	3.11	6.8	2.60	6.8	2.34	6.8	2.08	6.8	1.84	6.8	1.58	-	-
	-7	6.8	3.59	6.8	2.92	6.8	2.59	6.8	2.25	6.8	1.95	6.8	1.62	-	-
	2	8.2	4.34	8.0	3.62	8.0	3.19	8.0	2.76	8.0	2.42	8.0	2.04	7.5	1.77
	7	9.2	5.14	9.0	4.64	9.0	4.06	9.0	3.49	9.0	3.13	9.0	2.73	9.0	2.31
	12	10.7	5.80	10.3	5.38	10.3	4.70	10.3	4.03	10.3	3.59	10.3	3.12	10.3	2.60
	15	11.4	6.20	10.9	5.74	10.9	5.05	10.9	4.36	10.9	3.88	10.9	3.35	10.9	2.80
20	12.5	6.82	11.7	6.40	11.7	5.56	11.7	4.72	11.7	4.25	11.7	3.75	11.7	3.19	
Min	-20	-	-	5.5	1.81	5.4	1.67	5.2	1.51	-	-	-	-	-	-
	-15	-	-	6.5	2.18	6.5	1.96	6.4	1.71	6.3	1.55	6.2	1.36	-	-
	-10	6.8	3.11	6.8	2.60	6.8	2.34	6.8	2.08	6.8	1.84	6.8	1.58	-	-
	-7	5.3	3.52	4.3	2.72	3.8	2.40	4.0	2.09	3.4	1.84	3.4	1.56	-	-
	2	8.2	4.34	5.8	3.70	5.0	3.24	5.4	2.78	4.5	2.48	4.7	2.15	-	-
	7	9.2	5.14	5.4	4.48	5.1	3.91	4.7	3.33	4.0	2.97	3.6	2.59	-	-
	12	10.7	5.80	4.4	4.95	4.1	4.20	3.7	3.46	3.2	3.12	2.8	2.76	-	-
	15	11.4	6.20	4.9	5.43	4.4	4.57	4.1	3.72	3.4	3.40	3.1	3.04	-	-
20	12.5	6.82	9.7	6.04	9.1	5.32	8.5	4.60	7.6	4.09	6.7	3.54	-	-	

■ PUHZ-SW120V/YHA(-BS)

Water outlet temperature[°C]		25		35		40		45		50		55		60	
Ambient temperature[°C]		Capacity	COP	Capacity	COP	Capacity	COP	Capacity	COP	Capacity	COP	Capacity	COP	Capacity	COP
Max	-20	-	-	8.0	1.74	7.9	1.60	7.8	1.46	-	-	-	-	-	-
	-15	-	-	9.6	2.10	9.5	1.88	9.4	1.66	9.3	1.50	9.2	1.32	-	-
	-10	11.2	2.92	11.1	2.43	11.1	2.19	11.1	1.94	10.8	1.73	10.6	1.51	-	-
	-7	12.6	3.21	12.4	2.65	12.3	2.38	12.2	2.10	11.9	1.89	11.5	1.66	-	-
	2	13.8	3.50	13.4	3.07	13.2	2.75	13.0	2.44	12.5	2.16	12.0	1.86	11.2	1.54
	7	18.0	4.40	17.3	4.03	16.9	3.60	16.6	3.18	15.9	2.86	15.2	2.52	14.5	2.13
	12	20.8	5.07	19.8	4.58	19.4	4.09	18.9	3.61	18.2	3.25	17.4	2.87	16.7	2.44
	15	22.0	5.34	21.0	4.83	20.5	4.32	20.0	3.80	19.2	3.43	18.4	3.02	17.7	2.58
20	23.2	5.64	22.2	5.11	21.7	4.58	21.2	4.04	20.5	3.66	19.7	3.25	19.0	2.80	
Nominal	-20	-	-	8.0	1.74	7.9	1.60	7.8	1.46	-	-	-	-	-	-
	-15	-	-	9.6	2.10	9.5	1.88	9.4	1.66	9.3	1.50	9.2	1.32	-	-
	-10	11.2	2.92	11.1	2.43	11.1	2.19	11.1	1.94	10.8	1.73	10.6	1.51	-	-
	-7	11.2	3.38	11.2	2.85	11.2	2.49	11.2	2.14	11.2	1.92	11.2	1.68	-	-
	2	12.0	3.76	12.0	3.24	12.0	2.88	12.0	2.52	12.0	2.20	12.0	1.86	11.2	1.54
	7	16.0	4.58	16.0	4.10	16.0	3.67	16.0	3.23	15.9	2.86	15.2	2.52	14.5	2.13
	12	18.4	5.38	18.4	4.74	18.4	4.19	18.4	3.64	18.2	3.25	17.4	2.87	16.7	2.44
	15	19.4	5.66	19.4	5.01	19.4	4.43	19.4	3.84	19.2	3.43	18.4	3.02	17.7	2.58
20	20.6	5.95	20.6	5.31	20.6	4.71	20.6	4.10	20.5	3.66	19.7	3.25	19.0	2.80	
Mid	-20	-	-	6.4	1.78	6.3	1.65	6.2	1.51	-	-	-	-	-	-
	-15	-	-	7.6	2.17	7.6	1.94	7.5	1.71	7.5	1.55	7.4	1.37	-	-
	-10	9.0	3.23	8.9	2.56	8.9	2.30	8.9	2.04	8.7	1.84	8.5	1.61	-	-
	-7	9.0	3.54	9.0	2.87	9.0	2.54	9.0	2.20	9.0	1.96	9.0	1.70	-	-
	2	9.6	4.17	9.6	3.57	9.6	3.16	9.6	2.75	9.6	2.37	9.6	1.95	8.9	1.70
	7	12.8	5.03	12.8	4.43	12.8	3.91	12.8	3.40	12.7	3.02	12.2	2.61	11.6	2.17
	12	14.7	5.83	14.7	5.11	14.7	4.50	14.7	3.89	14.5	3.47	14.0	3.02	13.3	2.53
	15	15.6	6.18	15.6	5.42	15.6	4.78	15.6	4.14	15.4	3.70	14.7	3.23	14.1	2.71
20	16.5	6.62	16.5	5.89	16.5	5.21	16.5	4.52	16.4	4.04	15.8	3.53	15.2	2.96	
Min	-20	-	-	6.4	1.78	6.3	1.65	6.2	1.51	-	-	-	-	-	-
	-15	-	-	7.6	2.17	7.6	1.94	7.5	1.71	7.5	1.55	7.4	1.37	-	-
	-10	9.0	3.23	8.9	2.56	8.9	2.30	8.9	2.04	8.7	1.84	8.5	1.61	-	-
	-7	5.9	3.49	4.2	2.68	4.1	2.36	3.9	2.04	3.7	1.77	3.4	1.49	-	-
	2	9.0	4.33	5.9	3.68	5.7	3.24	5.5	2.80	5.1	2.43	4.8	2.03	-	-
	7	10.8	5.24	5.8	4.39	5.4	3.77	5.0	3.14	4.4	2.59	3.9	2.00	-	-
	12	13.2	5.93	5.7	5.45	5.2	4.51	4.8	3.58	4.2	2.94	3.6	2.27	-	-
	15	14.1	6.42	6.2	6.02	5.7	4.98	5.2	3.94	4.6	3.25	3.9	2.52	-	-
20	15.5	6.62	12.3	6.26	11.7	5.35	11.2	4.43	10.8	3.94	10.5	3.39	-	-	

■ PUHZ-SW160YKA(-BS)

Water outlet temperature[°C]		25		35		40		45		50		55		60	
Ambient temperature[°C]		Capacity	COP	Capacity	COP	Capacity	COP	Capacity	COP	Capacity	COP	Capacity	COP	Capacity	COP
Max	-20	-	-	11.2	2.25	10.2	1.99	9.4	1.75	-	-	-	-	-	-
	-15	-	-	11.6	2.37	10.9	2.14	10.3	1.90	9.9	1.67	-	-	-	-
	-10	14.2	3.00	12.6	2.61	12.0	2.36	11.6	2.11	11.2	1.87	-	-	-	-
	-7	14.7	3.22	13.4	2.80	13.0	2.54	12.5	2.27	12.2	2.01	11.8	1.76	-	-
	2	20.8	3.50	19.9	2.94	19.4	2.63	18.9	2.34	18.3	2.06	17.7	1.81	17.1	1.57
	7	28.7	4.58	27.7	3.78	27.1	3.37	26.5	2.99	25.8	2.64	25.3	2.35	24.4	2.06
	12	33.5	5.42	32.4	4.37	31.7	3.89	31.0	3.44	30.1	3.03	29.2	2.67	28.2	2.34
	15	36.6	5.92	35.3	4.74	34.6	4.20	33.7	3.71	32.8	3.27	31.8	2.88	30.7	2.53
20	42.4	6.80	40.8	5.37	39.9	4.76	38.9	4.20	37.8	3.71	36.6	3.27	35.4	2.88	
Nominal	-20	-	-	11.2	2.25	10.2	1.99	9.4	1.75	-	-	-	-	-	-
	-15	-	-	11.6	2.37	10.9	2.14	10.3	1.90	9.9	1.67	-	-	-	-
	-10	14.2	3.00	12.6	2.61	12.0	2.36	11.6	2.11	11.2	1.87	-	-	-	-
	-7	14.7	3.22	13.4	2.80	13.0	2.54	12.5	2.27	12.2	2.01	11.8	1.76	-	-
	2	16.0	3.98	16.0	3.11	16.0	2.85	16.0	2.36	16.0	2.17	16.0	1.87	16.0	1.61
	7	22.0	5.32	22.0	4.20	22.0	3.78	22.0	3.20	22.0	2.86	22.0	2.47	22.0	2.13
	12	26.0	6.36	26.0	4.94	26.0	4.31	26.0	3.75	26.0	3.25	26.0	2.81	26.0	2.42
	15	28.4	7.00	28.4	5.36	28.4	4.67	28.4	4.05	28.4	3.51	28.4	3.03	28.4	2.62
20	33.0	8.12	33.0	6.13	33.0	5.31	33.0	4.60	33.0	3.97	33.0	3.44	33.0	2.97	
Mid	-20	-	-	10.0	2.26	9.0	2.01	8.4	1.76	-	-	-	-	-	-
	-15	-	-	10.4	2.41	9.7	2.17	9.2	1.92	8.8	1.69	-	-	-	-
	-10	12.2	3.09	11.2	2.66	10.7	2.41	10.3	2.15	10.0	1.90	-	-	-	-
	-7	12.8	3.33	11.9	2.87	11.5	2.59	11.2	2.31	10.8	2.04	10.5	1.79	-	-
	2	12.8	4.23	12.8	3.42	12.8	3.02	12.8	2.65	12.8	2.30	12.8	1.98	12.8	1.70
	7	17.6	5.73	17.6	4.57	17.6	4.01	17.6	3.50	17.6	3.04	17.6	2.63	17.6	2.26
	12	20.8	6.86	20.8	5.30	20.8	4.62	20.8	4.02	20.8	3.48	20.8	3.00	20.8	2.59
	15	22.7	7.56	22.7	5.79	22.7	5.03	22.7	4.37	22.7	3.77	22.7	3.26	22.7	2.81
20	26.4	8.80	26.4	6.65	26.4	5.76	26.4	4.98	26.4	4.31	26.4	3.72	26.4	3.21	
Min	-20	-	-	9.5	2.26	8.6	2.01	8.0	1.77	-	-	-	-	-	-
	-15	-	-	9.9	2.42	9.3	2.17	8.8	1.93	8.5	1.70	-	-	-	-
	-10	12.1	3.09	10.9	2.68	10.4	2.42	10.0	2.16	9.6	1.90	-	-	-	-
	-7	12.6	3.34	11.6	2.88	11.2	2.61	10.8	2.32	10.5	2.05	10.1	1.80	-	-
	2	11.2	4.27	10.6	3.46	10.2	3.07	9.9	2.70	9.5	2.37	9.0	2.07	8.6	1.80
	7	6.1	4.80	5.8	3.91	5.7	3.50	5.5	3.13	5.4	2.78	5.2	2.46	5.0	2.18
	12	7.2	5.67	6.8	4.53	6.6	4.02	6.4	3.57	6.2	3.16	5.9	2.80	5.7	2.48
	15	7.9	6.25	7.4	4.94	7.2	4.38	6.9	3.87	6.7	3.42	6.5	3.02	6.2	2.67
20	9.3	7.29	8.6	5.69	8.3	5.01	8.0	4.42	7.7	3.89	7.4	3.43	7.1	3.04	

■ PUHZ-SW200YKA(-BS)

Water outlet temperature[°C]		25		35		40		45		50		55		60	
Ambient temperature[°C]		Capacity	COP	Capacity	COP	Capacity	COP	Capacity	COP	Capacity	COP	Capacity	COP	Capacity	COP
Max	-20	-	-	13.1	2.19	11.8	1.94	10.9	1.70	-	-	-	-	-	-
	-15	-	-	13.5	2.30	12.6	2.07	11.9	1.84	11.5	1.62	-	-	-	-
	-10	16.4	2.88	14.5	2.50	13.8	2.27	13.3	2.03	12.9	1.80	-	-	-	-
	-7	16.8	3.06	15.3	2.67	14.8	2.42	14.3	2.17	14.0	1.92	13.6	1.69	-	-
	2	22.3	3.16	21.5	2.70	21.1	2.44	20.8	2.19	20.4	1.95	20.1	1.73	19.6	1.53
	7	30.9	4.40	30.1	3.66	29.6	3.29	29.1	2.93	28.6	2.61	28.0	2.31	27.6	2.07
	12	35.8	5.16	34.9	4.20	34.4	3.76	33.8	3.34	33.1	2.97	32.3	2.63	31.5	2.33
	15	39.0	5.62	38.0	4.53	37.4	4.04	36.7	3.59	35.9	3.19	35.1	2.83	34.1	2.51
20	44.9	6.43	43.6	5.12	42.9	4.56	42.0	4.04	41.1	3.59	40.1	3.19	39.0	2.83	
Nominal	-20	-	-	13.1	2.19	11.8	1.94	10.9	1.70	-	-	-	-	-	-
	-15	-	-	13.5	2.30	12.6	2.07	11.9	1.84	11.5	1.62	-	-	-	-
	-10	15.4	2.92	14.5	2.50	13.8	2.27	13.3	2.03	12.9	1.80	-	-	-	-
	-7	16.3	3.10	15.3	2.67	14.8	2.42	14.3	2.17	14.0	1.92	13.6	1.69	-	-
	2	20.0	3.39	20.0	2.80	20.0	2.51	20.0	2.20	20.0	1.96	20.0	1.73	19.6	1.53
	7	25.0	5.02	25.0	4.00	25.0	3.57	25.0	3.10	25.0	2.80	25.0	2.45	24.9	2.14
	12	29.2	5.95	29.2	4.67	29.2	4.11	29.2	3.60	29.2	3.15	29.2	2.75	29.2	2.40
	15	31.8	6.52	31.8	5.06	31.9	4.44	31.8	3.88	31.9	3.39	31.8	2.96	31.9	2.58
20	36.8	7.53	36.8	5.75	36.8	5.02	36.8	4.37	36.8	3.81	36.8	3.33	36.8	2.91	
Mid	-20	-	-	10.5	2.23	9.4	1.98	8.8	1.74	-	-	-	-	-	-
	-15	-	-	10.8	2.37	10.1	2.13	9.6	1.89	9.2	1.67	-	-	-	-
	-10	12.3	3.06	11.6	2.63	11.1	2.37	10.7	2.11	10.4	1.86	-	-	-	-
	-7	13.0	3.30	12.3	2.83	11.8	2.55	11.5	2.27	11.2	2.01	10.9	1.76	-	-
	2	16.0	3.80	16.0	3.10	16.0	2.70	16.0	2.40	16.0	2.10	16.0	1.80	16.0	1.60
	7	20.0	5.50	20.0	4.40	20.0	3.90	20.0	3.40	20.0	3.00	20.0	2.60	20.0	2.20
	12	23.4	6.56	23.4	5.11	23.4	4.48	23.4	3.91	23.4	3.41	23.4	2.97	23.4	2.58
	15	25.5	7.22	25.5	5.56	25.5	4.85	25.5	4.23	25.5	3.68	25.5	3.20	25.5	2.79
20	29.4	8.38	29.4	6.36	29.4	5.53	29.4	4.80	29.4	4.17	29.4	3.63	29.4	3.16	
Min	-20	-	-	9.4	2.24	8.5	1.98	8.0	1.74	-	-	-	-	-	-
	-15	-	-	9.9	2.39	9.3	2.15	8.8	1.90	8.4	1.67	-	-	-	-
	-10	12.0	3.08	10.8	2.65	10.3	2.39	9.9	2.13	9.6	1.88	-	-	-	-
	-7	12.6	3.32	11.6	2.86	11.2	2.58	10.8	2.30	10.4	2.02	10.1	1.77	-	-
	2	11.1	4.22	10.5	3.41	10.2	3.03	9.8	2.66	9.4	2.33	9.0	2.03	8.5	1.77
	7	6.1	4.76	5.8	3.87	5.7	3.45	5.5	3.08	5.3	2.74	5.2	2.43	5.0	2.16
	12	7.1	5.61	6.8	4.47	6.5	3.97	6.3	3.53	6.1	3.12	5.9	2.76	5.7	2.45
	15	7.9	6.18	7.4	4.88	7.2	4.32	6.9	3.82	6.7	3.38	6.4	2.99	6.2	2.64
20	9.3	7.20	8.6	5.62	8.3	4.95	8.0	4.36	7.7	3.84	7.4	3.39	7.1	3.00	

Outdoor unit

■ PUAZ-SW75V/YAA(-BS)

Water outlet temperature[°C]		25		35		40		45		50		55		60	
Ambient temperature[°C]		Capacity	COP	Capacity	COP	Capacity	COP	Capacity	COP	Capacity	COP	Capacity	COP	Capacity	COP
Max	-20	-	-	6.0	1.85	5.8	1.60	5.6	1.39	-	-	-	-	-	-
	-15	-	-	7.3	2.30	7.1	1.99	6.8	1.73	6.6	1.49	-	-	-	-
	-10	8.8	3.58	8.4	2.98	8.1	2.58	7.8	2.24	7.5	1.93	7.3	1.67	-	-
	-7	8.8	3.77	8.4	3.14	8.1	2.73	7.8	2.36	7.5	2.04	7.3	1.77	-	-
	2	9.2	3.78	8.7	3.15	8.4	2.73	8.1	2.36	7.8	2.04	7.5	2.04	7.2	1.76
	7	10.1	4.92	9.5	4.10	9.2	3.56	8.9	3.08	8.6	2.66	8.3	2.60	7.9	1.99
	12	11.8	5.52	11.2	4.60	10.8	3.99	10.5	3.45	10.1	2.99	9.7	2.58	9.3	2.23
	15	12.9	5.74	12.2	4.78	11.8	4.14	11.4	3.59	11.0	3.10	10.6	2.68	10.1	2.32
20	14.8	6.73	14.0	5.61	13.6	4.86	13.1	4.21	12.6	3.64	12.1	3.15	11.6	2.73	
Nominal	-20	-	-	4.8	2.45	4.8	2.13	4.8	1.89	-	-	-	-	-	-
	-15	-	-	5.2	2.88	5.2	2.50	5.2	2.22	5.2	1.93	-	-	-	-
	-10	5.8	3.62	5.8	3.02	5.8	2.62	5.8	2.32	5.8	2.02	5.8	1.75	-	-
	-7	6.3	3.79	6.3	3.16	6.3	2.75	6.3	2.43	6.3	2.12	6.3	1.83	-	-
	2	7.5	4.08	7.5	3.40	7.5	3.06	7.5	2.68	7.5	2.38	7.5	2.04	7.2	1.76
	7	8.0	5.28	8.0	4.40	8.0	3.83	8.0	3.40	8.0	3.08	8.0	2.64	7.9	1.99
	12	8.0	6.30	8.0	5.25	8.0	4.57	8.0	4.04	8.0	3.68	8.0	3.15	8.0	2.89
	15	8.0	6.76	8.0	5.63	8.0	4.90	8.0	4.33	8.0	3.94	8.0	3.38	8.0	3.10
20	8.0	8.32	8.0	6.93	8.0	6.03	8.0	5.34	8.0	4.85	8.0	4.16	8.0	3.81	
Mid	-20	-	-	3.8	0.00	3.8	0.00	3.8	0.00	-	-	-	-	-	-
	-15	-	-	4.1	2.92	4.1	2.54	4.1	2.25	4.1	1.96	-	-	-	-
	-10	4.6	3.72	4.6	3.10	4.6	2.70	4.6	2.39	4.6	2.08	4.6	1.80	-	-
	-7	5.0	3.93	5.0	3.28	5.0	2.85	5.0	2.52	5.0	2.19	5.0	1.90	-	-
	2	6.0	4.23	6.0	3.53	6.0	3.18	6.0	2.72	6.0	2.47	6.0	2.12	6.0	1.94
	7	6.4	5.74	6.4	4.78	6.4	4.16	6.4	3.68	6.4	3.35	6.4	2.87	6.3	2.63
	12	6.4	6.63	6.4	5.53	6.4	4.81	6.4	4.26	6.4	3.87	6.4	3.32	6.4	3.04
	15	6.4	7.06	6.4	5.88	6.4	5.12	6.4	4.53	6.4	4.12	6.4	3.53	6.4	3.24
20	6.4	8.59	6.4	7.16	6.4	6.23	6.4	5.51	6.4	5.01	6.4	4.30	6.4	3.94	
Min	-20	-	-	3.2	2.55	3.1	2.21	3.0	1.91	-	-	-	-	-	-
	-15	-	-	3.8	3.03	3.7	2.63	3.6	2.28	3.4	1.97	-	-	-	-
	-10	4.6	3.89	4.3	3.24	4.2	2.81	4.1	2.43	3.9	2.11	3.8	1.82	-	-
	-7	3.9	4.16	3.7	3.47	3.6	3.00	3.5	2.60	3.3	2.25	3.2	1.95	-	-
	2	3.6	4.61	3.4	3.84	3.3	3.33	3.1	2.88	3.0	2.50	2.9	2.16	2.8	1.87
	7	3.1	5.72	2.9	4.76	2.8	4.13	2.7	3.57	2.6	3.09	2.5	2.68	2.4	2.31
	12	2.9	6.99	2.8	5.83	2.7	5.05	2.6	4.37	2.5	3.78	2.4	3.27	2.3	2.83
	15	3.2	7.02	3.0	5.85	2.9	5.07	2.8	4.39	2.7	3.80	2.6	3.28	2.5	2.84
20	3.6	8.52	3.4	7.10	3.3	6.16	3.2	5.33	3.1	4.61	3.0	3.99	2.9	3.45	

■ PUAZ-SW100V/YAA(-BS)

Water outlet temperature[°C]		25		35		40		45		50		55		60	
Ambient temperature[°C]		Capacity	COP	Capacity	COP	Capacity	COP	Capacity	COP	Capacity	COP	Capacity	COP	Capacity	COP
Max	-20	-	-	7.8	1.90	7.7	1.69	7.5	1.49	-	-	-	-	-	-
	-15	-	-	8.8	2.13	8.6	1.89	8.4	1.68	8.2	1.48	-	-	-	-
	-10	10.5	3.00	10.1	2.43	9.9	2.16	9.7	1.91	9.4	1.69	9.2	1.49	-	-
	-7	10.4	3.49	10.0	2.85	9.8	2.55	9.6	2.27	9.5	2.02	9.3	1.76	-	-
	2	11.1	3.64	10.7	2.97	10.5	2.66	10.3	2.37	10.2	2.11	10.0	2.13	9.6	1.84
	7	13.9	4.88	13.1	4.07	12.7	3.52	12.3	3.05	11.8	2.64	11.4	2.68	10.9	1.98
	12	16.1	5.50	15.2	4.58	14.7	3.97	14.2	3.44	13.7	2.98	13.2	2.57	12.6	2.23
	15	17.4	5.86	16.4	4.88	15.9	4.23	15.4	3.66	14.8	3.17	14.3	2.74	13.7	2.37
20	19.9	6.46	18.8	5.39	18.2	4.67	17.6	4.04	17.0	3.50	16.3	3.03	15.6	2.62	
Nominal	-20	-	-	6.0	2.20	6.0	1.92	6.0	1.67	-	-	-	-	-	-
	-15	-	-	6.8	2.52	6.8	2.19	6.8	1.89	6.8	1.63	-	-	-	-
	-10	8.4	3.67	8.4	3.13	8.4	2.70	8.4	2.33	8.4	2.00	8.4	1.71	-	-
	-7	8.9	3.83	8.9	3.20	8.9	2.77	8.9	2.40	8.9	2.07	8.9	1.79	-	-
	2	10.0	3.98	10.0	3.32	10.0	2.88	10.0	2.66	10.0	2.36	10.0	2.13	9.6	1.84
	7	11.2	5.35	11.2	4.46	11.2	3.87	11.2	3.39	11.2	3.01	11.2	2.71	10.9	1.98
	12	11.2	6.56	11.2	5.46	11.2	4.74	11.2	4.15	11.2	3.68	11.2	3.32	11.2	2.84
	15	11.2	7.26	11.2	6.05	11.2	5.24	11.2	4.60	11.2	4.08	11.2	3.67	11.2	3.14
20	11.2	8.47	11.2	7.06	11.2	6.12	11.2	5.37	11.2	4.76	11.2	4.29	11.2	3.67	
Mid	-20	-	-	5.0	2.37	4.8	2.06	4.7	1.78	-	-	-	-	-	-
	-15	-	-	5.7	2.68	5.5	2.32	5.3	2.01	5.1	1.74	-	-	-	-
	-10	6.7	3.88	6.7	3.31	6.7	2.86	6.7	2.46	6.7	2.11	6.7	1.81	-	-
	-7	7.1	4.06	7.1	3.38	7.1	2.93	7.1	2.54	7.1	2.19	7.1	1.90	-	-
	2	8.0	4.22	8.0	3.51	8.0	3.05	8.0	2.82	8.0	2.50	8.0	2.25	7.7	1.95
	7	9.0	5.66	9.0	4.72	9.0	4.09	9.0	3.59	9.0	3.18	9.0	2.86	8.7	2.09
	12	9.0	6.94	9.0	5.16	9.0	4.48	9.0	3.87	9.0	3.35	9.0	2.90	9.0	2.51
	15	9.0	7.68	9.0	5.71	9.0	4.95	9.0	4.29	9.0	3.71	9.0	3.21	9.0	2.77
20	9.0	8.97	9.0	6.67	9.0	5.78	9.0	5.01	9.0	4.33	9.0	3.75	9.0	3.24	
Min	-20	-	-	5.0	2.37	4.8	2.06	4.7	1.78	4.5	1.54	-	-	-	-
	-15	-	-	5.7	2.68	5.5	2.32	5.3	2.01	5.1	1.74	-	-	-	-
	-10	3.7	3.42	3.5	2.85	3.4	2.47	3.2	2.14	3.1	1.85	3.0	1.60	-	-
	-7	3.8	3.53	3.6	2.94	3.5	2.55	3.4	2.21	3.2	1.91	3.1	1.65	-	-
	2	3.9	4.56	3.7	3.80	3.6	3.29	3.5	2.85	3.3	2.47	3.2	2.13	3.2	2.13
	7	3.6	5.38	3.4	4.48	3.3	3.89	3.2	3.36	3.1	2.91	3.0	2.52	3.0	2.52
	12	4.3	6.38	4.1	5.32	4.0	4.61	3.8	3.99	3.7	3.45	3.6	2.99	3.6	2.99
	15	4.7	6.92	4.5	5.77	4.3	5.00	4.2	4.33	4.0	3.74	3.9	3.24	3.9	3.24
20	5.4	8.00	5.1	6.67	5.0	5.78	4.8	5.00	4.6	4.33	4.4	3.74	4.4	3.74	

■ PUHZ-FRP71VHA2

Water outlet temperature[°C]		25		35		40		45		50		55		60	
Ambient temperature[°C]		Capacity	COP	Capacity	COP	Capacity	COP	Capacity	COP	Capacity	COP	Capacity	COP	Capacity	COP
Max	-20	5.0	2.00	4.9	1.70	4.8	1.55	4.7	1.40	-	-	-	-	-	-
	-15	6.0	2.50	5.8	2.00	5.6	1.95	5.4	1.90	5.4	1.80	-	-	-	-
	-10	6.7	2.70	6.5	2.40	6.3	2.25	6.1	2.10	6.1	1.85	6.1	1.60	-	-
	-7	7.4	3.30	7.4	2.70	7.0	2.50	6.6	2.30	6.6	2.10	6.6	1.90	-	-
	2	7.8	4.10	7.8	2.80	7.9	2.65	7.9	2.50	7.9	2.35	7.9	2.20	7.4	1.65
	7	10.0	4.20	10.2	3.70	10.2	3.35	10.2	3.00	10.1	2.75	10.0	2.50	9.5	2.26
	12	12.0	4.50	12.3	3.95	12.0	3.58	11.6	3.20	11.1	2.95	10.5	2.70	10.0	2.38
	15	13.0	4.80	13.1	4.10	12.7	3.70	12.3	3.30	11.7	3.05	11.0	2.80	10.5	2.50
20	15.5	5.20	14.7	4.40	14.3	3.95	13.8	3.50	12.7	3.25	11.5	3.00	11.0	2.56	
Nominal	-20	4.0	2.03	4.0	1.73	4.0	1.58	4.0	1.43	-	-	-	-	-	-
	-15	5.0	2.53	5.0	2.02	5.0	1.97	5.0	1.91	5.0	1.80	-	-	-	-
	-10	6.0	2.72	6.0	2.41	6.0	2.26	6.0	2.10	6.0	1.85	6.0	1.60	-	-
	-7	7.0	3.33	7.0	2.80	6.5	2.56	6.0	2.32	6.0	2.11	6.0	1.91	-	-
	2	7.5	4.29	7.5	2.83	7.5	2.69	7.5	2.54	7.5	2.38	7.5	2.21	7.0	1.66
	7	8.0	5.16	8.0	4.08	8.0	3.65	8.0	3.22	8.0	2.89	8.0	2.56	7.5	2.27
	12	9.0	6.21	9.0	4.65	9.0	4.11	9.0	3.58	9.0	3.18	9.0	2.79	8.5	2.39
	15	9.7	6.79	9.7	4.94	9.7	4.35	9.7	3.75	9.7	3.33	9.7	2.90	9.2	2.51
20	10.2	8.61	10.2	5.80	10.2	5.03	10.2	4.26	10.2	3.71	10.2	3.16	9.7	2.57	
Mid	-20	3.2	2.06	3.2	1.76	3.2	1.61	3.2	1.46	-	-	-	-	-	-
	-15	4.0	2.55	4.0	2.05	4.0	2.00	4.0	1.95	4.0	1.83	-	-	-	-
	-10	4.8	2.75	4.8	2.45	4.8	2.29	4.8	2.14	4.8	1.88	4.8	1.63	-	-
	-7	5.6	3.42	5.6	2.83	5.2	2.59	4.8	2.35	4.8	2.14	4.8	1.94	-	-
	2	6.0	5.21	6.0	3.18	6.0	2.95	6.0	2.71	6.0	2.48	6.0	2.24	5.5	1.70
	7	6.4	5.92	6.4	4.31	6.4	3.85	6.4	3.39	6.4	3.00	6.4	2.61	5.9	2.40
	12	7.2	7.23	7.2	5.03	7.2	4.43	7.2	3.84	7.2	3.37	7.2	2.90	6.7	2.55
	15	7.7	7.94	7.7	5.41	7.7	4.74	7.7	4.08	7.7	3.56	7.7	3.04	7.2	2.65
20	8.1	9.90	8.1	6.42	8.1	5.55	8.1	4.68	8.1	4.04	8.1	3.41	7.6	2.80	
Min	-20	2.0	2.10	2.0	1.80	2.0	1.65	2.0	1.50	-	-	-	-	-	-
	-15	2.3	2.60	2.3	2.10	2.3	2.05	2.3	2.00	2.1	1.90	-	-	-	-
	-10	3.0	2.80	2.7	2.50	2.7	2.35	2.7	2.20	2.2	1.95	1.7	1.70	-	-
	-7	3.5	3.55	3.2	3.00	3.1	2.70	3.0	2.40	2.5	2.20	2.0	2.00	-	-
	2	4.8	5.95	4.5	3.50	4.2	3.23	3.8	2.95	3.4	2.63	3.0	2.30	2.5	1.71
	7	5.5	6.35	5.2	4.50	4.8	4.05	4.3	3.60	3.9	3.15	3.5	2.70	3.0	2.41
	12	6.2	7.80	5.9	5.30	5.3	4.75	4.7	4.20	4.4	3.65	4.0	3.10	3.5	2.56
	15	6.6	8.60	6.3	5.75	5.7	5.15	5.0	4.55	4.7	3.93	4.3	3.30	3.8	2.66
20	7.5	10.30	7.2	6.70	6.4	5.95	5.6	5.20	5.3	4.50	4.9	3.80	4.4	2.81	

Outdoor unit

■ PUAZ-SHW80VHA(-BS)

Water outlet temperature[°C]		25		35		40		45		50		55		60	
Ambient temperature[°C]		Capacity	COP	Capacity	COP	Capacity	COP	Capacity	COP	Capacity	COP	Capacity	COP	Capacity	COP
Max	(INJ) -20	-	-	7.5	2.25	7.5	2.01	7.5	1.78	-	-	-	-	-	-
	(INJ) -15	-	-	10.1	2.39	9.9	2.11	9.7	1.83	9.4	1.61	9.2	1.39	-	-
	(INJ) -10	11.4	3.12	10.9	2.67	10.6	2.36	10.3	2.05	10.1	1.82	9.9	1.56	-	-
	(INJ) -7	12.0	3.25	11.4	2.84	11.0	2.51	10.7	2.19	10.5	1.94	10.2	1.68	-	-
	(INJ) 2	12.9	3.49	12.1	3.22	11.7	2.94	11.4	2.67	11.1	2.37	10.8	2.05	10.4	1.71
	7	13.2	4.80	12.4	4.34	12.0	3.88	11.6	3.42	11.2	3.10	10.8	2.75	10.4	2.37
	12	15.1	5.45	14.3	4.93	13.7	4.37	13.1	3.80	12.7	3.45	12.3	3.06	11.9	2.72
	15	16.1	5.74	15.5	5.33	14.8	4.68	14.1	4.03	13.6	3.65	13.2	3.25	12.8	2.93
20	17.5	6.10	16.6	5.66	16.2	5.03	15.7	4.41	15.2	4.00	14.7	3.56	14.3	3.10	
Nominal	(INJ) -20	-	-	7.5	2.25	7.5	2.01	7.5	1.78	-	-	-	-	-	-
	(INJ) -15	-	-	8.0	2.52	8.0	2.20	8.0	1.88	8.0	1.66	8.0	1.42	-	-
	(INJ) -10	8.0	3.40	8.0	2.90	8.0	2.56	8.0	2.21	8.0	1.98	8.0	1.73	-	-
	(INJ) -7	8.0	3.63	8.0	3.13	8.0	2.77	8.0	2.41	8.0	2.17	8.0	1.91	-	-
	(INJ) 2	8.1	4.36	8.0	3.55	8.0	3.20	8.0	2.85	8.0	2.52	8.0	2.16	8.0	1.78
	7	9.1	5.21	8.0	4.65	8.0	4.04	8.0	3.42	8.0	3.14	8.0	2.83	8.0	2.48
	12	10.6	5.77	9.2	5.42	9.2	4.75	9.2	4.07	9.2	3.67	9.2	3.25	9.2	2.79
	15	11.3	6.22	10.1	5.94	10.1	5.22	10.1	4.50	10.1	4.03	10.1	3.53	10.1	3.00
20	12.4	6.76	10.9	6.43	10.9	5.68	10.9	4.92	10.9	4.38	10.9	3.80	10.9	3.19	
Mid	(INJ) -20	-	-	6.0	2.13	6.0	1.94	6.0	1.74	-	-	-	-	-	-
	(INJ) -15	-	-	6.4	2.53	6.4	2.28	6.4	2.03	6.4	1.80	6.4	1.53	-	-
	(INJ) -10	6.4	3.39	6.4	2.94	6.4	2.62	6.4	2.29	6.4	2.03	6.4	1.75	-	-
	(INJ) -7	6.4	3.65	6.4	3.18	6.4	2.81	6.4	2.44	6.4	2.16	6.4	1.87	-	-
	(INJ) 2	8.1	4.36	6.4	3.96	6.4	3.52	6.4	3.07	6.4	2.74	6.4	2.38	6.4	1.79
	7	9.1	5.21	6.4	4.77	6.4	4.22	6.4	3.67	6.4	3.26	6.4	2.84	6.4	2.46
	12	10.6	5.77	7.4	5.60	7.4	4.93	7.4	4.26	7.4	3.79	7.4	3.29	7.4	2.76
	15	11.3	6.22	8.0	6.15	8.0	5.40	8.0	4.65	8.0	4.14	8.0	3.59	8.0	2.94
20	12.4	6.76	10.1	5.99	9.8	5.27	9.5	4.56	9.1	4.08	8.7	3.55	8.7	3.13	
Min	-20	-	-	6.0	2.13	6.0	1.94	6.0	1.74	-	-	-	-	-	-
	-15	-	-	6.4	2.53	6.4	2.28	6.4	2.03	6.4	1.80	6.4	1.53	-	-
	-10	6.4	3.39	6.4	2.94	6.4	2.62	6.4	2.29	6.4	2.03	6.4	1.75	-	-
	-7	6.0	3.61	4.9	2.85	4.7	2.49	4.5	2.13	4.3	1.92	4.1	1.69	-	-
	2	8.1	4.36	5.8	3.71	5.5	3.23	5.3	2.75	5.0	2.46	4.7	2.14	-	-
	7	9.1	5.21	5.6	4.44	5.3	3.86	5.1	3.27	4.8	2.93	4.6	2.55	-	-
	12	10.6	5.77	4.4	4.95	4.2	4.29	4.0	3.63	3.8	3.24	3.6	2.83	-	-
	15	11.3	6.22	4.8	5.37	4.6	4.68	4.4	3.98	4.2	3.56	4.0	3.09	-	-
20	12.4	6.76	10.1	5.99	9.8	5.27	9.5	4.56	9.1	4.08	8.7	3.55	-	-	

■ PUAZ-SHW112V/YHA(-BS)

Water outlet temperature[°C]		25		35		40		45		50		55		60	
Ambient temperature[°C]		Capacity	COP	Capacity	COP	Capacity	COP	Capacity	COP	Capacity	COP	Capacity	COP	Capacity	COP
Max	(INJ) -20	-	-	10.5	2.14	10.5	1.93	10.5	1.73	-	-	-	-	-	-
	(INJ) -15	-	-	13.6	2.17	13.4	1.97	13.2	1.77	13.1	1.57	12.9	1.36	-	-
	(INJ) -10	14.8	2.69	14.4	2.40	14.2	2.15	14.0	1.91	13.9	1.72	13.9	1.52	-	-
	(INJ) -7	15.3	2.83	14.9	2.54	14.7	2.27	14.5	1.99	14.5	1.82	14.4	1.61	-	-
	(INJ) 2	14.1	3.37	13.5	3.10	13.1	2.81	12.8	2.51	12.5	2.24	12.2	1.95	11.7	1.61
	7	15.7	4.54	14.8	4.04	14.4	3.65	14.0	3.26	13.6	2.93	13.2	2.58	12.8	2.31
	12	18.1	5.06	17.1	4.52	16.5	4.03	15.8	3.54	15.4	3.20	14.9	2.85	14.6	2.56
	15	19.4	5.38	18.6	4.84	17.8	4.27	16.9	3.71	16.4	3.38	16.0	3.01	15.6	2.71
20	20.7	5.54	19.7	5.06	19.2	4.52	18.7	3.99	18.2	3.65	17.7	3.28	17.4	2.96	
Nominal	(INJ) -20	-	-	10.5	2.14	10.5	1.93	10.5	1.73	-	-	-	-	-	-
	(INJ) -15	-	-	11.2	2.34	11.2	2.08	11.2	1.82	11.2	1.60	11.2	1.38	-	-
	(INJ) -10	11.2	3.13	11.2	2.65	11.2	2.33	11.2	2.01	11.2	1.80	11.2	1.55	-	-
	(INJ) -7	11.2	3.37	11.2	2.84	11.2	2.48	11.2	2.12	11.2	1.91	11.2	1.67	-	-
	(INJ) 2	11.2	3.90	11.2	3.34	11.2	3.02	11.2	2.70	11.2	2.37	11.2	2.01	11.2	1.66
	7	11.2	5.03	11.2	4.46	11.2	3.99	11.2	3.51	11.2	3.11	11.2	2.67	11.2	2.37
	12	12.9	5.66	12.9	5.01	12.9	4.45	12.9	3.88	12.9	3.47	12.9	3.02	12.9	2.67
	15	14.1	5.97	14.1	5.38	14.1	4.75	14.1	4.12	14.1	3.70	14.1	3.25	14.1	2.88
20	15.2	6.54	15.2	5.74	15.2	5.05	15.2	4.36	15.2	3.94	15.2	3.47	15.2	3.08	
Mid	(INJ) -20	-	-	8.4	2.23	8.4	2.00	8.4	1.76	-	-	-	-	-	-
	(INJ) -15	-	-	9.0	2.43	9.0	2.14	9.0	1.84	9.0	1.62	9.0	1.39	-	-
	(INJ) -10	9.0	3.33	9.0	2.83	9.0	2.48	9.0	2.14	9.0	1.91	9.0	1.65	-	-
	(INJ) -7	9.0	3.61	9.0	3.06	9.0	2.69	9.0	2.33	9.0	2.07	9.0	1.80	-	-
	(INJ) 2	9.0	4.22	9.0	3.46	9.0	3.13	9.0	2.81	9.0	2.49	9.0	2.15	9.0	1.75
	7	9.0	5.18	9.0	4.61	9.0	4.06	9.0	3.51	9.0	3.15	9.0	2.75	9.0	2.42
	12	10.5	5.73	10.3	5.28	10.3	4.64	10.3	4.01	10.3	3.60	10.3	3.16	10.3	2.77
	15	11.3	6.17	11.3	5.72	11.3	5.03	11.3	4.34	11.3	3.90	11.3	3.42	11.3	3.01
20	12.3	6.70	12.2	6.15	12.2	5.41	12.2	4.66	12.2	4.18	12.2	3.67	12.2	3.22	
Min	-20	-	-	8.4	2.23	8.4	2.00	8.4	1.76	-	-	-	-	-	-
	-15	-	-	9.0	2.43	9.0	2.14	9.0	1.84	9.0	1.62	9.0	1.39	-	-
	-10	9.0	3.33	9.0	2.83	9.0	2.48	9.0	2.14	9.0	1.91	9.0	1.65	-	-
	-7	6.0	3.59	4.9	2.84	4.7	2.48	4.5	2.12	4.3	1.91	4.1	1.68	-	-
	2	8.0	4.37	5.7	3.69	5.5	3.21	5.2	2.73	5.0	2.44	4.7	2.12	-	-
	7	9.0	5.18	5.5	4.41	5.3	3.83	5.1	3.25	4.8	2.91	4.6	2.53	-	-
	12	10.5	5.73	4.4	4.92	4.2	4.26	4.0	3.61	3.8	3.22	3.6	2.80	-	-
	15	11.3	6.17	4.8	5.33	4.6	4.64	4.4	3.95	4.2	3.53	4.0	3.07	-	-
20	12.3	6.70	10.1	5.94	9.8	5.23	9.5	4.52	9.1	4.04	8.7	3.53	-	-	

■ PUAZ-SHW140YHA(-BS)

Water outlet temperature[°C]		25		35		40		45		50		55		60	
Ambient temperature[°C]		Capacity	COP	Capacity	COP	Capacity	COP	Capacity	COP	Capacity	COP	Capacity	COP	Capacity	COP
Max	(INJ) -20	-	-	11.8	2.08	11.8	1.89	11.8	1.69	-	-	-	-	-	-
	(INJ) -15	-	-	14.0	2.15	14.0	1.95	14.0	1.75	13.3	1.57	13.0	1.37	-	-
	(INJ) -10	15.2	2.64	15.0	2.33	15.0	2.11	14.9	1.89	14.6	1.71	14.3	1.51	-	-
	(INJ) -7	15.9	2.76	15.7	2.44	15.5	2.21	15.4	1.98	15.3	1.80	15.1	1.60	-	-
	(INJ) 2	16.8	3.02	15.8	2.71	15.3	2.43	14.8	2.16	14.6	1.95	14.4	1.72	13.8	1.47
	7	17.3	4.33	16.4	3.79	16.0	3.39	15.6	2.98	15.2	2.73	14.8	2.45	14.4	2.22
	12	20.0	4.78	19.0	4.23	18.2	3.75	17.5	3.27	17.1	3.00	16.6	2.70	16.3	2.48
	20	22.6	5.21	21.6	4.69	21.1	4.20	20.6	3.72	20.1	3.42	19.6	3.09	19.5	2.81
Nominal	(INJ) -20	-	-	11.8	2.08	11.8	1.89	11.8	1.69	-	-	-	-	-	-
	(INJ) -15	-	-	14.0	2.15	14.0	1.95	14.0	1.75	13.3	1.57	13.0	1.37	-	-
	(INJ) -10	14.0	2.77	14.0	2.42	14.0	2.17	14.0	1.92	14.0	1.73	14.0	1.53	-	-
	(INJ) -7	14.0	2.98	14.0	2.58	14.0	2.30	14.0	2.02	14.0	1.84	14.0	1.64	-	-
	(INJ) 2	14.0	3.34	14.0	2.96	14.0	2.70	14.0	2.44	14.0	2.17	14.0	1.89	13.8	1.47
	7	14.0	4.75	14.0	4.22	14.0	3.75	14.0	3.28	14.0	2.91	14.0	2.49	14.0	2.23
	12	16.2	5.21	16.2	4.60	16.2	4.08	16.2	3.55	16.2	3.18	16.2	2.77	16.2	2.50
	20	19.0	5.81	19.0	5.10	19.0	4.50	19.0	3.90	19.0	3.54	19.0	3.14	19.0	2.84
Mid	(INJ) -20	-	-	9.4	2.16	9.4	1.94	9.4	1.73	-	-	-	-	-	-
	(INJ) -15	-	-	11.2	2.31	11.2	2.06	11.2	1.80	10.6	1.59	10.4	1.38	-	-
	(INJ) -10	11.2	3.12	11.2	2.65	11.2	2.33	11.2	2.01	11.2	1.80	11.2	1.55	-	-
	(INJ) -7	11.2	3.38	11.2	2.85	11.2	2.50	11.2	2.14	11.2	1.91	11.2	1.66	-	-
	(INJ) 2	11.2	3.90	11.2	3.34	11.2	3.02	11.2	2.70	11.2	2.38	11.2	2.03	11.1	1.65
	7	11.2	4.98	11.2	4.45	11.2	3.94	11.2	3.44	11.2	3.06	11.2	2.64	11.2	2.34
	12	12.9	5.57	12.9	4.98	12.9	4.40	12.9	3.82	12.9	3.42	12.9	2.99	12.9	2.64
	20	15.2	6.47	15.2	5.67	15.2	4.99	15.2	4.31	15.2	3.90	15.2	3.44	15.2	3.04
Min	-20	-	-	9.4	2.16	9.4	1.94	9.4	1.73	-	-	-	-	-	-
	-15	-	-	11.2	2.31	11.2	2.06	11.2	1.80	10.6	1.59	10.4	1.38	-	-
	-10	11.2	3.12	11.2	2.65	11.2	2.33	11.2	2.01	11.2	1.80	11.2	1.55	-	-
	-7	6.0	3.57	4.9	2.82	4.7	2.46	4.5	2.10	4.3	1.90	4.1	1.67	-	-
	2	8.0	4.35	5.7	3.67	5.5	3.19	5.2	2.72	5.0	2.43	4.7	2.11	-	-
	7	9.0	5.15	5.5	4.38	5.3	3.81	5.0	3.23	4.8	2.89	4.5	2.52	-	-
	12	10.5	5.69	4.4	4.88	4.2	4.23	4.0	3.58	3.8	3.20	3.6	2.78	-	-
	20	11.3	6.13	4.8	5.30	4.6	4.61	4.4	3.93	4.2	3.51	4.0	3.05	-	-
20	12.3	6.66	10.0	5.90	9.7	5.19	9.4	4.49	9.1	4.01	8.7	3.50	-	-	

■ PUAZ-SHW230YKA2

Water outlet temperature[°C]		35		40		45		50		55		60	
Ambient temperature[°C]		Capacity	COP	Capacity	COP	Capacity	COP	Capacity	COP	Capacity	COP	Capacity	COP
Max	(INJ) -20	20.3	2.06	19.8	1.84	19.3	1.62	-	-	-	-	-	-
	(INJ) -15	22.9	2.20	22.7	2.00	22.5	1.80	21.6	1.61	20.8	1.41	-	-
	(INJ) -10	25.6	2.34	25.6	2.16	25.7	1.98	25.7	1.84	25.6	1.69	-	-
	(INJ) -7	27.1	2.43	27.4	2.26	27.7	2.09	28.1	1.98	28.4	1.86	-	-
	(INJ) 2	23.2	2.29	23.0	2.16	22.9	2.02	22.8	2.02	22.8	2.02	22.7	1.98
	7	2.80	3.28	27.9	3.07	27.9	2.85	27.7	2.65	27.5	2.42	26.3	2.05
	12	29.5	3.48	29.3	3.21	29.1	2.94	28.8	2.75	28.5	2.54	27.4	2.24
	20	32.1	3.80	31.6	3.45	31.1	3.09	30.6	2.92	30.1	2.73	29.3	2.54
Nominal	(INJ) -20	20.3	2.06	19.8	1.84	19.3	1.62	-	-	-	-	-	-
	(INJ) -15	22.9	2.20	22.7	2.00	22.5	1.80	21.6	1.61	20.8	1.41	-	-
	(INJ) -10	23.0	2.60	23.0	2.36	23.0	2.12	23.0	1.99	23.0	1.85	-	-
	(INJ) -7	23.0	2.85	23.0	2.58	23.0	2.32	23.0	2.22	23.0	2.11	-	-
	(INJ) 2	23.0	2.37	23.0	2.16	22.9	2.02	22.8	2.02	22.8	2.02	22.7	1.98
	7	23.0	3.65	23.0	3.34	23.0	3.02	23.0	2.76	23.0	2.47	23.0	2.09
	12	24.3	4.10	24.3	3.68	24.3	3.26	24.3	2.98	24.3	2.67	24.3	2.34
	20	25.7	4.29	25.7	3.84	25.7	3.39	25.7	3.10	25.7	2.79	25.7	2.49
Mid	(INJ) -20	16.2	2.00	15.8	1.87	15.4	1.73	-	-	-	-	-	-
	(INJ) -15	18.3	2.36	18.2	2.16	18.0	1.97	17.3	1.82	16.6	1.66	-	-
	(INJ) -10	18.4	2.72	18.4	2.46	18.4	2.21	18.4	2.06	18.4	1.90	-	-
	(INJ) -7	18.4	2.93	18.4	2.64	18.4	2.35	18.4	2.21	18.4	2.05	-	-
	(INJ) 2	18.4	2.90	18.4	2.60	18.3	2.30	18.3	2.26	18.2	2.21	18.1	2.08
	7	18.4	4.01	18.4	3.58	18.4	3.14	18.4	2.83	18.4	2.49	18.4	2.24
	12	19.4	4.58	19.4	4.05	19.4	3.52	19.4	3.15	19.4	2.76	19.4	2.55
	20	22.5	5.55	22.5	4.89	22.5	4.23	22.5	3.80	22.5	3.34	22.5	3.05
Min	-20	16.2	2.00	15.8	1.87	15.4	1.73	-	-	-	-	-	-
	-15	18.3	2.36	18.2	2.16	18.0	1.97	17.3	1.82	16.6	1.66	-	-
	-10	18.4	2.72	18.4	2.46	18.4	2.21	18.4	2.06	18.4	1.90	-	-
	-7	12.6	2.72	12.1	2.41	11.6	2.10	10.7	1.83	9.7	1.53	-	-
	2	11.8	3.52	11.3	3.11	10.8	2.70	10.0	2.35	9.1	1.97	-	-
	7	11.4	4.31	10.5	3.73	9.6	3.15	8.4	2.64	7.2	2.10	-	-
	12	11.4	5.08	10.4	4.39	9.4	3.70	8.3	3.39	7.2	3.05	-	-
	20	13.5	5.58	12.4	4.87	11.4	4.17	10.4	3.85	9.5	3.49	-	-
20	20.0	5.94	19.1	5.29	18.3	4.63	17.5	4.21	16.7	3.75	-	-	

Outdoor unit

■ PUHZ-SHW80V/YAA(-BS)

Water outlet temperature[°C]		25		35		40		45		50		55		60	
Ambient temperature[°C]		Capacity	COP	Capacity	COP	Capacity	COP	Capacity	COP	Capacity	COP	Capacity	COP	Capacity	COP
Max	(INJ) -20	-	-	7.3	2.23	7.0	1.94	6.8	1.68	-	-	-	-	-	-
	(INJ) -15	-	-	8.7	2.63	8.4	2.30	8.0	2.00	7.7	1.84	7.4	1.59	-	-
	(INJ) -10	10.8	3.65	10.2	3.04	9.9	2.64	9.5	2.28	9.2	1.98	8.8	1.71	-	-
	(INJ) -7	9.7	3.99	9.2	3.32	8.9	2.88	8.6	2.49	8.3	2.16	8.0	2.02	-	-
	(INJ) 2	9.4	4.09	8.9	3.41	8.6	2.96	8.3	2.71	8.0	2.49	7.7	2.15	7.4	1.86
	7	9.9	5.36	9.3	4.47	9.0	3.87	8.7	3.35	8.4	2.90	8.1	2.69	7.7	2.17
	12	11.6	6.29	10.9	5.24	10.6	4.54	10.2	3.93	9.9	3.40	9.5	2.94	9.1	2.55
	15	12.6	6.87	11.9	5.72	11.5	4.96	11.1	4.29	10.7	3.72	10.3	3.21	9.9	2.78
20	14.5	7.95	13.7	6.63	13.3	5.74	12.8	4.97	12.4	4.30	11.9	3.72	11.4	3.22	
Nominal	(INJ) -20	-	-	7.3	2.23	7.0	1.94	6.8	1.68	-	-	-	-	-	-
	(INJ) -15	-	-	8.0	2.74	8.0	2.38	8.0	2.00	7.7	1.84	7.4	1.59	-	-
	(INJ) -10	8.0	3.52	8.0	2.93	8.0	2.55	8.0	2.26	8.0	1.96	8.0	1.70	-	-
	(INJ) -7	8.0	4.17	8.0	3.48	8.0	3.02	8.0	2.68	8.0	2.33	8.0	2.02	-	-
	(INJ) 2	8.0	4.26	8.0	3.55	8.0	3.20	8.0	2.85	8.0	2.49	7.7	2.15	7.4	1.86
	7	8.0	5.58	8.0	4.65	8.0	4.05	8.0	3.42	8.0	3.12	8.0	2.70	7.7	2.17
	12	8.0	6.54	8.0	5.45	8.0	4.74	8.0	4.20	8.0	3.65	8.0	3.16	8.0	2.78
	15	8.0	7.14	8.0	5.95	8.0	5.18	8.0	4.58	8.0	3.99	8.0	3.45	8.0	3.03
20	8.0	8.15	8.0	6.79	8.0	5.91	8.0	5.23	8.0	4.55	8.0	3.94	8.0	3.46	
Mid	-20	-	-	5.8	2.42	5.6	2.10	5.4	1.86	-	-	-	-	-	-
	-15	-	-	6.4	2.95	6.4	2.57	6.4	2.27	6.4	1.98	6.4	1.71	-	-
	-10	6.4	3.87	6.4	3.22	6.4	2.80	6.4	2.48	6.4	2.16	6.4	1.87	-	-
	-7	6.4	4.34	6.4	3.62	6.4	3.15	6.4	2.79	6.4	2.42	6.4	2.10	-	-
	2	6.4	4.43	6.4	3.70	6.4	3.21	6.4	2.85	6.4	2.48	6.4	2.14	6.4	1.88
	7	6.4	5.65	6.4	4.71	6.4	4.10	6.4	3.63	6.4	3.16	6.4	2.73	6.4	2.40
	12	6.4	6.47	6.4	5.39	6.4	4.69	6.4	4.15	6.4	3.61	6.4	3.13	6.4	2.75
	15	6.4	6.97	6.4	5.81	6.4	5.06	6.4	4.47	6.4	3.89	6.4	3.37	6.4	2.96
20	6.4	8.04	6.4	6.70	6.4	5.83	6.4	5.16	6.4	4.49	6.4	3.88	6.4	3.42	
Min	-20	-	-	5.0	2.37	4.8	2.06	4.7	1.78	4.5	1.54	-	-	-	-
	-15	-	-	5.7	2.68	5.5	2.32	5.3	2.01	5.1	1.74	4.9	1.51	-	-
	-10	3.7	3.42	3.5	2.85	3.4	2.47	3.2	2.14	3.1	1.85	3.0	1.60	-	-
	-7	3.8	3.53	3.6	2.94	3.5	2.55	3.4	2.21	3.2	1.91	3.1	1.65	-	-
	2	3.9	4.56	3.7	3.80	3.6	3.29	3.5	2.85	3.3	2.47	3.2	2.13	3.1	1.85
	7	3.6	5.38	3.4	4.48	3.3	3.89	3.2	3.36	3.1	2.91	3.0	2.52	2.8	2.18
	12	4.3	6.38	4.1	5.32	4.0	4.61	3.8	3.99	3.7	3.45	3.6	2.99	3.4	2.58
	15	4.7	6.92	4.5	5.77	4.3	5.00	4.2	4.33	4.0	3.74	3.9	3.24	3.7	2.80
20	5.4	8.00	5.1	6.67	5.0	5.78	4.8	5.00	4.6	4.33	4.4	3.74	4.3	3.24	

■ PUHZ-SHW112V/YAA(-BS)

Water outlet temperature[°C]		25		35		40		45		50		55		60	
Ambient temperature[°C]		Capacity	COP	Capacity	COP	Capacity	COP	Capacity	COP	Capacity	COP	Capacity	COP	Capacity	COP
Max	(INJ) -20	-	-	10.2	2.02	10.0	1.79	9.7	1.57	-	-	-	-	-	-
	(INJ) -15	-	-	11.9	2.30	11.6	2.04	11.2	1.80	10.8	1.56	10.4	1.35	-	-
	(INJ) -10	12.8	2.34	12.2	2.12	11.9	2.13	11.5	2.13	11.2	2.01	10.8	1.74	-	-
	(INJ) -7	12.8	2.62	12.2	2.37	11.9	2.38	11.5	2.39	11.2	2.25	10.8	1.95	-	-
	(INJ) 2	12.3	2.62	11.7	3.16	11.4	2.87	11.2	2.60	10.8	2.25	10.4	1.94	9.9	1.68
	7	13.9	4.88	13.1	4.07	12.7	3.52	12.3	3.05	11.8	2.64	11.4	2.70	10.9	1.98
	12	16.1	5.50	15.2	4.58	14.7	3.97	14.2	3.44	13.7	2.98	13.2	2.57	12.6	2.23
	15	17.4	5.86	16.4	4.88	15.9	4.23	15.4	3.66	14.8	3.17	14.3	2.74	13.7	2.37
20	19.9	6.46	18.8	5.39	18.2	4.67	17.6	4.04	17.0	3.50	16.3	3.03	15.6	2.62	
Nominal	(INJ) -20	-	-	10.2	2.02	10.0	1.79	9.7	1.57	-	-	-	-	-	-
	(INJ) -15	-	-	11.2	2.37	11.2	2.05	11.2	1.80	10.8	1.56	10.4	1.35	-	-
	(INJ) -10	11.2	3.57	11.2	2.98	11.2	2.58	11.2	2.26	11.2	2.01	10.8	1.74	-	-
	(INJ) -7	11.2	4.01	11.2	3.34	11.2	2.89	11.2	2.54	11.2	2.25	10.8	1.95	-	-
	(INJ) 2	11.2	3.86	11.2	3.22	11.2	2.90	11.2	2.60	10.8	2.25	10.4	1.94	9.9	1.68
	7	11.2	5.35	11.2	4.46	11.2	3.87	11.2	3.39	11.2	3.01	11.2	2.71	10.9	1.98
	12	11.2	6.56	11.2	5.46	11.2	4.74	11.2	4.15	11.2	3.68	11.2	3.32	11.2	2.84
	15	11.2	7.26	11.2	6.05	11.2	5.24	11.2	4.60	11.2	4.08	11.2	3.67	11.2	3.14
20	11.2	8.47	11.2	7.06	11.2	6.12	11.2	5.37	11.2	4.76	11.2	4.29	11.2	3.67	
Mid	(INJ) -20	-	-	8.2	2.14	8.0	1.89	7.7	1.66	-	-	-	-	-	-
	(INJ) -15	-	-	9.0	2.51	9.0	2.17	9.0	1.90	8.6	1.65	8.3	1.43	-	-
	(INJ) -10	9.0	3.78	9.0	3.15	9.0	2.73	9.0	2.39	9.0	2.12	8.6	1.84	-	-
	(INJ) -7	9.0	4.24	9.0	3.53	9.0	3.06	9.0	2.68	9.0	2.38	8.6	2.06	-	-
	(INJ) 2	9.0	4.09	9.0	3.41	9.0	3.07	9.0	2.75	8.6	2.38	8.3	2.06	8.0	1.78
	7	9.0	5.66	9.0	4.72	9.0	4.09	9.0	3.59	9.0	3.18	9.0	2.86	8.7	2.09
	12	9.0	6.94	9.0	5.16	9.0	4.48	9.0	3.87	9.0	3.35	9.0	2.90	9.0	2.51
	15	9.0	7.68	9.0	5.71	9.0	4.95	9.0	4.29	9.0	3.71	9.0	3.21	9.0	2.77
20	9.0	8.97	9.0	6.67	9.0	5.78	9.0	5.01	9.0	4.33	9.0	3.75	9.0	3.24	
Min	-20	-	-	5.0	2.37	4.8	2.06	4.7	1.78	4.5	1.54	-	-	-	-
	-15	-	-	5.7	2.68	5.5	2.32	5.3	2.01	5.1	1.74	4.9	1.51	-	-
	-10	3.7	3.42	3.5	2.85	3.4	2.47	3.2	2.14	3.1	1.85	3.0	1.60	-	-
	-7	3.8	3.53	3.6	2.94	3.5	2.55	3.4	2.21	3.2	1.91	3.1	1.65	-	-
	2	3.9	4.56	3.7	3.80	3.6	3.29	3.5	2.85	3.3	2.47	3.2	2.13	3.1	1.85
	7	3.6	5.38	3.4	4.48	3.3	3.89	3.2	3.36	3.1	2.91	3.0	2.52	2.8	2.18
	12	4.3	6.38	4.1	5.32	4.0	4.61	3.8	3.99	3.7	3.45	3.6	2.99	3.4	2.58
	15	4.7	6.92	4.5	5.77	4.3	5.00	4.2	4.33	4.0	3.74	3.9	3.24	3.7	2.80
20	5.4	8.00	5.1	6.67	5.0	5.78	4.8	5.00	4.6	4.33	4.4	3.74	4.3	3.24	

5 Performance data

Outdoor unit

Outdoor unit

■ PUMY-P112/125/140V/YKM(E)4(-BS) In case of ATW unit single connection

Water outlet temperature[°C]		25		35		40		45		50		55		60	
Ambient temperature[°C]		Capacity	COP	Capacity	COP	Capacity	COP	Capacity	COP	Capacity	COP	Capacity	COP	Capacity	COP
Max	-20	-	-	6.5	1.76	5.7	1.46	-	-	-	-	-	-	-	-
	-15	-	-	8.0	2.05	7.5	1.88	-	-	-	-	-	-	-	-
	-10	10.7	2.36	10.3	2.20	9.9	2.05	9.5	1.90	-	-	-	-	-	-
	-7	11.1	2.57	11.1	2.36	11.1	2.16	11.1	1.96	10.0	1.88	-	-	-	-
	2	11.6	2.87	11.3	2.62	11.1	2.37	10.8	2.12	10.7	1.91	10.6	1.71	-	-
	7	14.2	4.38	13.8	3.93	13.4	3.48	13.0	3.03	12.8	2.67	12.5	2.31	-	-
	12	15.4	4.81	14.9	4.31	14.5	3.81	14.0	3.31	13.8	2.91	13.5	2.51	-	-
Nominal	15	16.0	5.08	15.5	4.55	15.0	4.01	14.5	3.48	14.3	3.05	14.0	2.62	-	-
	20	17.5	5.64	17.1	5.06	16.7	4.48	16.3	3.90	16.2	3.46	16.1	3.02	-	-
	-20	-	-	6.5	1.76	5.7	1.46	-	-	-	-	-	-	-	-
	-15	-	-	8.0	2.05	7.5	1.88	-	-	-	-	-	-	-	-
	-10	8.0	2.63	8.0	2.42	8.0	2.20	8.0	1.99	-	-	-	-	-	-
	-7	8.0	2.99	8.0	2.72	8.0	2.44	8.0	2.16	8.0	1.94	-	-	-	-
	2	10.0	3.18	10.0	2.86	10.0	2.54	10.0	2.22	10.0	1.97	10.0	1.73	-	-
Mid	7	12.5	4.59	12.5	4.08	12.5	3.57	12.5	3.06	12.5	2.69	12.5	2.32	-	-
	12	13.5	5.05	13.5	4.48	13.5	3.92	13.5	3.35	13.5	2.93	13.5	2.51	-	-
	15	14.0	5.36	14.0	4.75	14.0	4.14	14.0	3.53	14.0	3.08	14.0	2.62	-	-
	20	15.5	5.90	15.5	5.26	15.5	4.62	15.5	3.99	15.5	3.50	15.5	3.02	-	-
	-20	-	-	5.2	1.85	4.5	1.45	-	-	-	-	-	-	-	-
	-15	-	-	6.4	2.15	6.0	1.95	-	-	-	-	-	-	-	-
	-10	6.4	2.79	6.4	2.54	6.4	2.29	6.4	2.04	-	-	-	-	-	-
Min	-7	6.4	3.05	6.4	2.77	6.4	2.49	6.4	2.21	6.4	1.96	-	-	-	-
	2	8.0	3.34	8.0	3.00	8.0	2.66	8.0	2.32	8.0	2.06	8.0	1.81	-	-
	7	10.0	4.75	10.0	4.25	10.0	3.74	10.0	3.23	10.0	2.83	10.0	2.42	-	-
	12	10.8	5.35	10.8	4.80	10.8	4.25	10.8	3.69	10.8	3.24	10.8	2.79	-	-
	15	11.2	5.82	11.2	5.22	11.2	4.62	11.2	4.02	11.2	3.50	11.2	2.99	-	-
	20	12.4	6.80	12.4	6.04	12.4	5.29	12.4	4.53	12.4	3.93	12.4	3.32	-	-
	-20	-	-	-	-	-	-	-	-	-	-	-	-	-	-
Min	-15	-	-	-	-	-	-	-	-	-	-	-	-	-	-
	-10	-	-	-	-	-	-	-	-	-	-	-	-	-	-
	-7	3.7	2.90	3.6	2.61	3.5	2.33	3.4	2.04	3.3	1.80	-	-	-	-
	2	3.8	3.30	4.5	3.17	4.2	2.75	4.0	2.34	3.8	2.00	3.5	1.72	-	-
	7	3.9	4.06	3.8	3.64	3.6	3.22	3.5	2.79	3.2	2.39	3.0	1.99	-	-
	12	4.5	5.10	4.4	4.54	4.3	3.99	4.1	3.43	3.8	2.93	3.6	2.43	-	-
	15	4.9	6.07	4.8	5.37	4.6	4.67	4.5	3.97	4.2	3.38	3.9	2.79	-	-
20	5.6	7.51	5.5	6.58	5.3	5.65	5.2	4.72	4.9	4.01	4.6	3.30	-	-	

Outdoor unit

5.3 Part load chart PUHZ-W50VHA2(-BS)

■ Water outlet temperature 35 [°C]

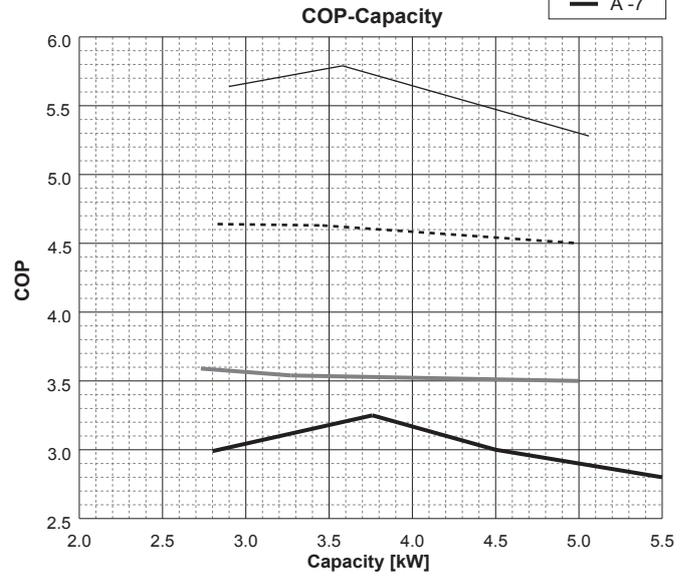
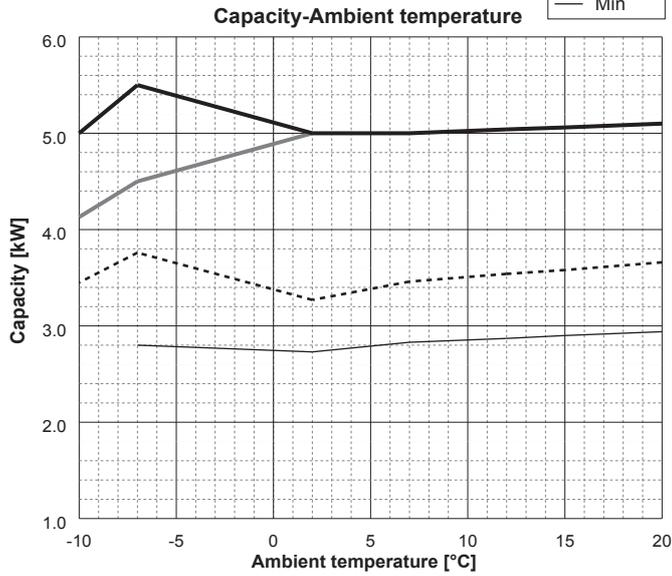

■ Water outlet temperature 45 [°C]

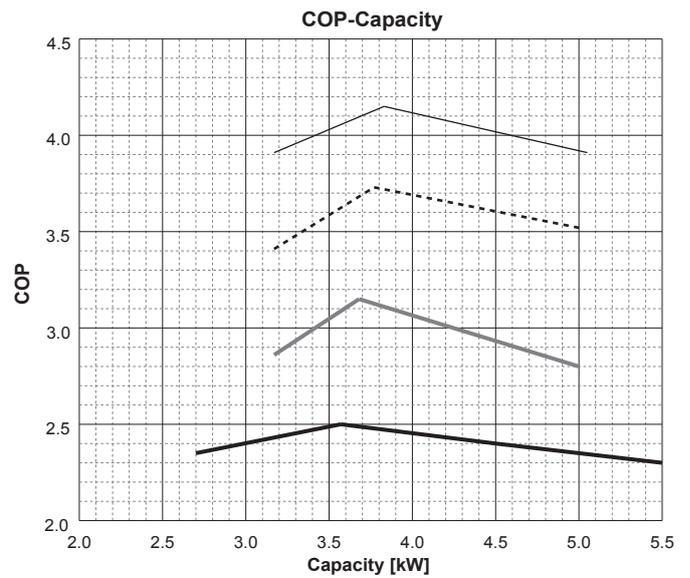
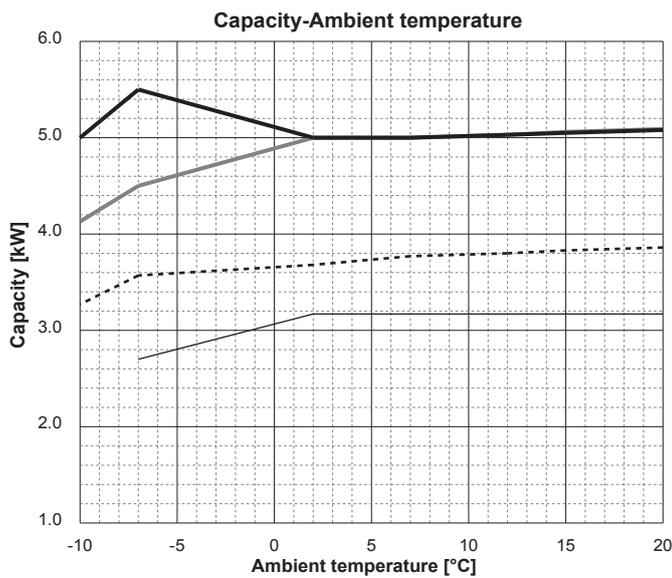

■ Water outlet temperature 55 [°C]

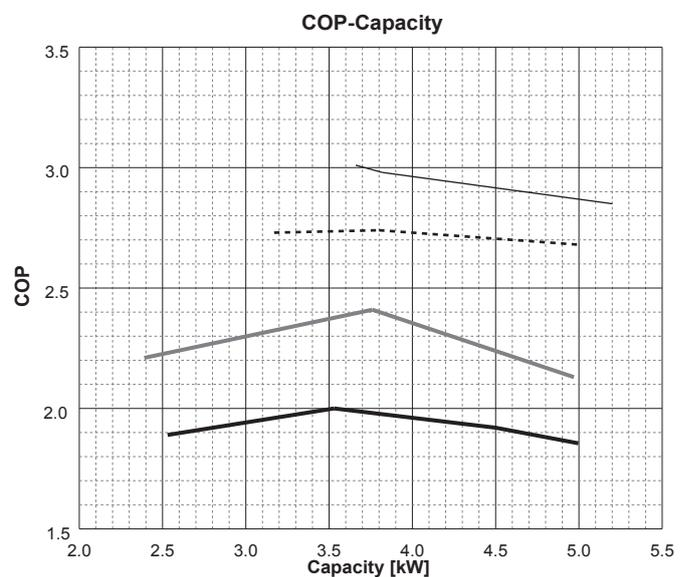
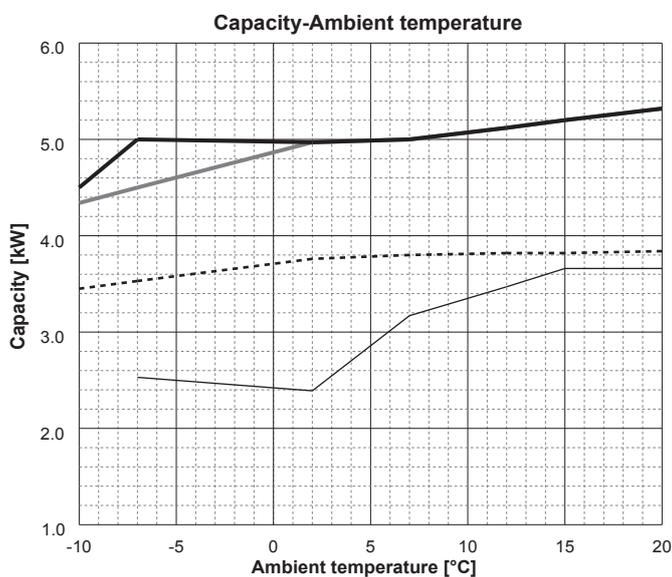

PUHZ-W85VHA2(-BS)

Water outlet temperature 35 [°C]

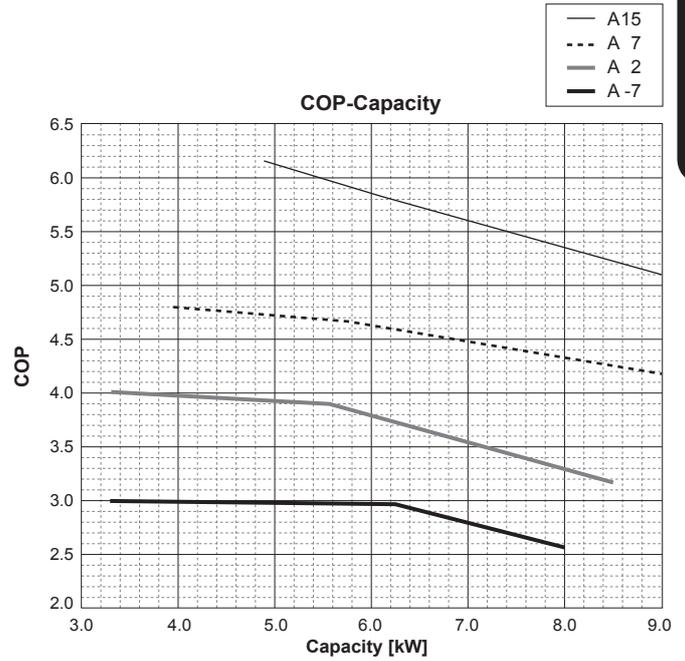
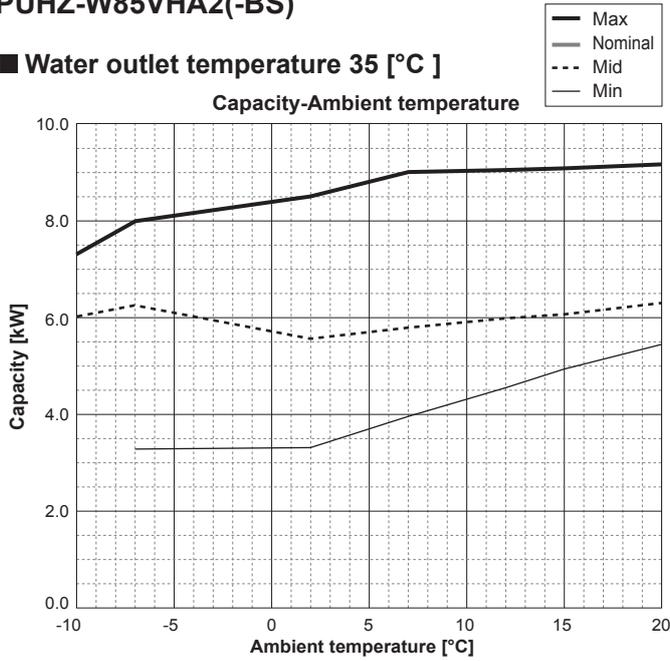

Water outlet temperature 45 [°C]

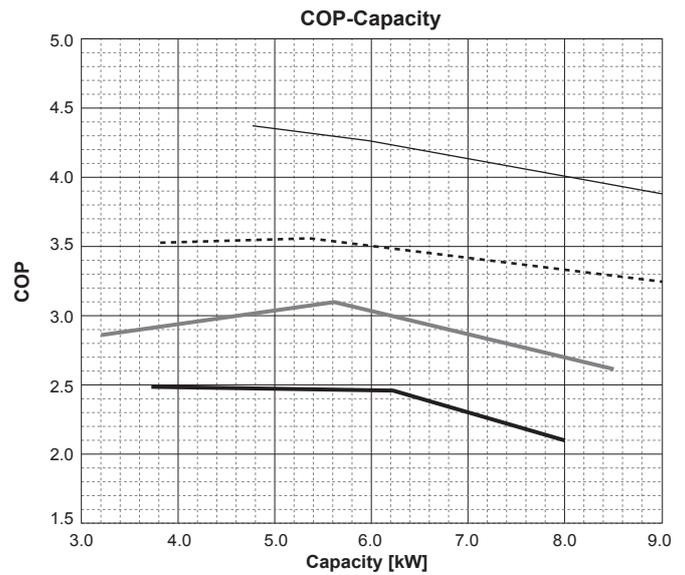
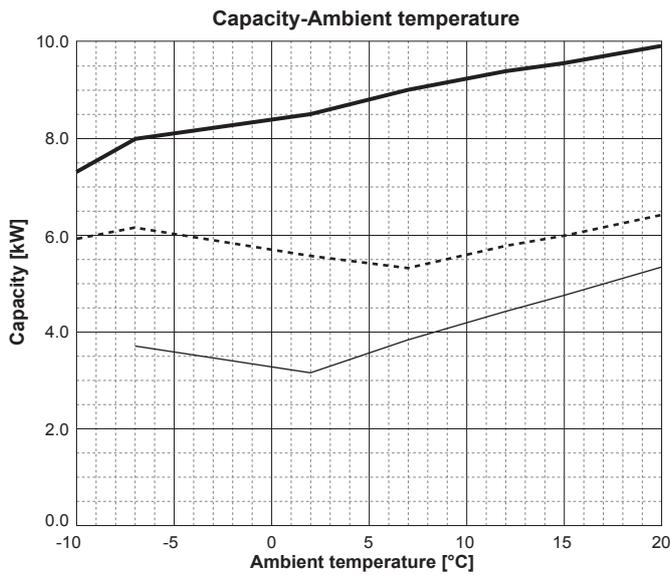

Water outlet temperature 55 [°C]

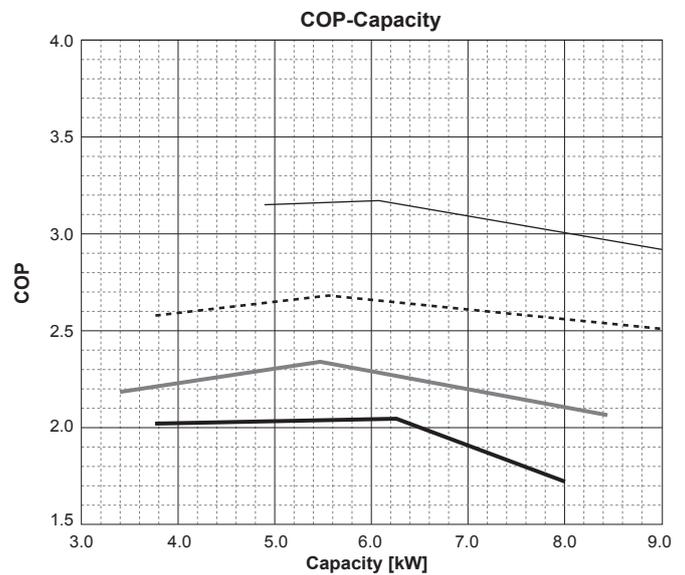
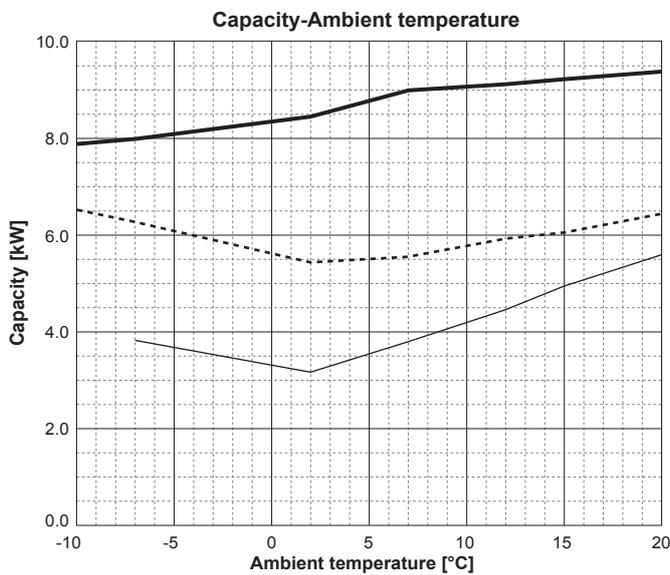

PUHZ-W112VHA(-BS)

■ **Water outlet temperature 35 [°C]**

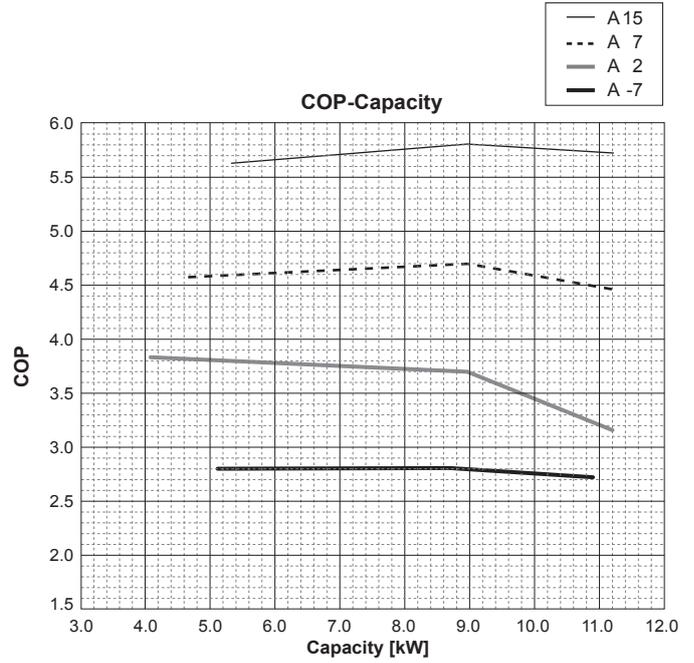
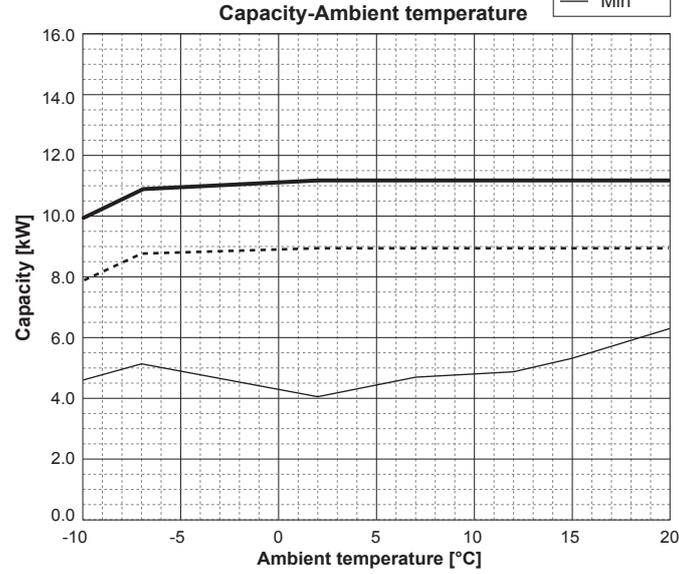

■ **Water outlet temperature 45 [°C]**

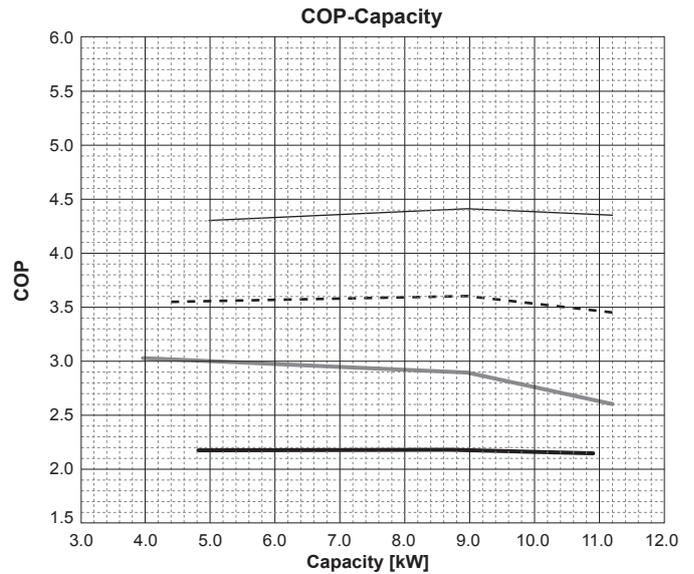
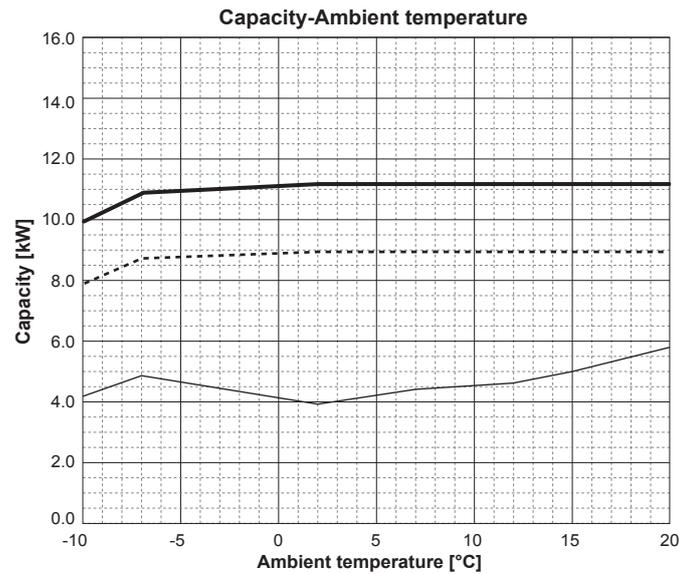

■ **Water outlet temperature 55 [°C]**

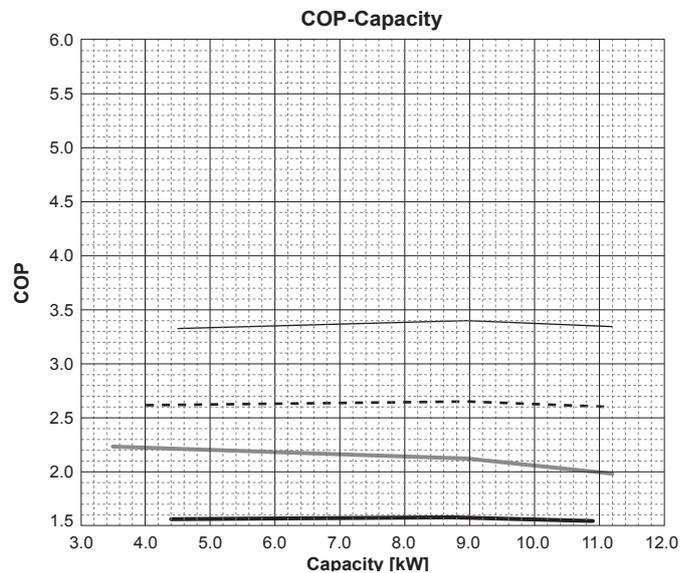
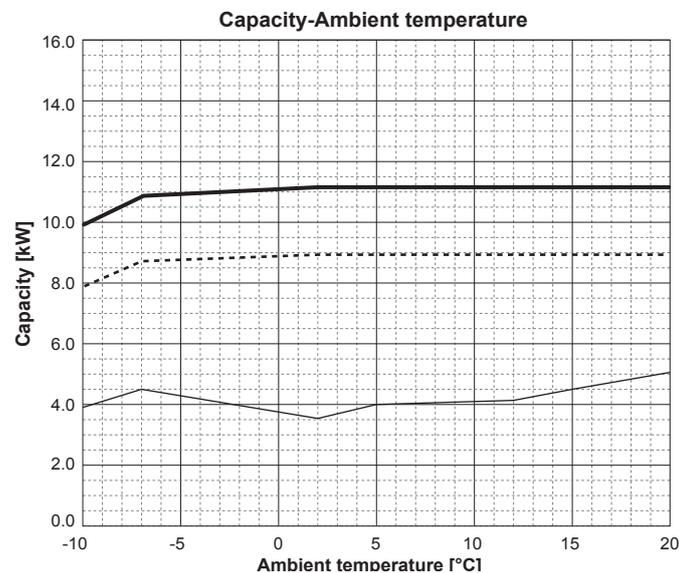

PUHZ-W85V/YAA

Water outlet temperature 35 [°C]

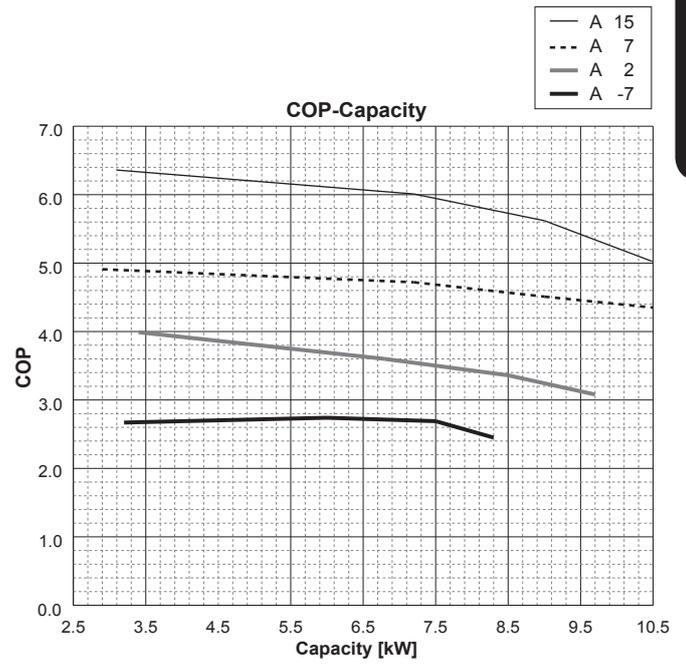
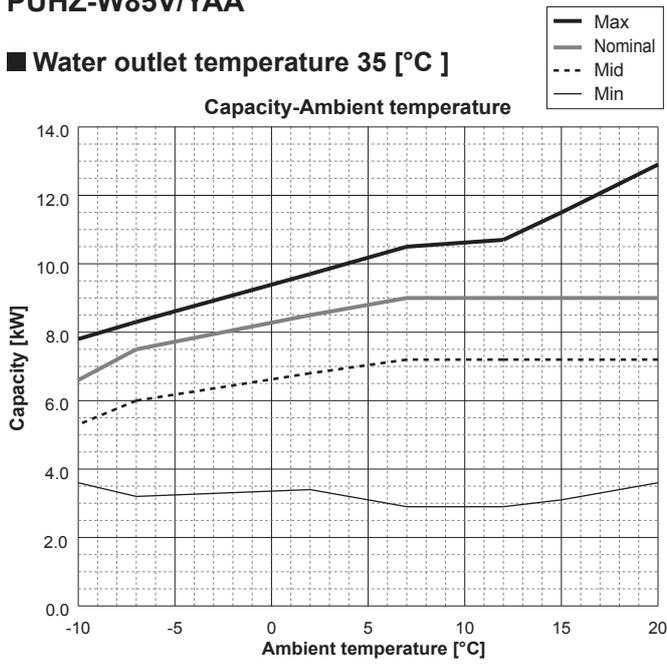

Water outlet temperature 45 [°C]

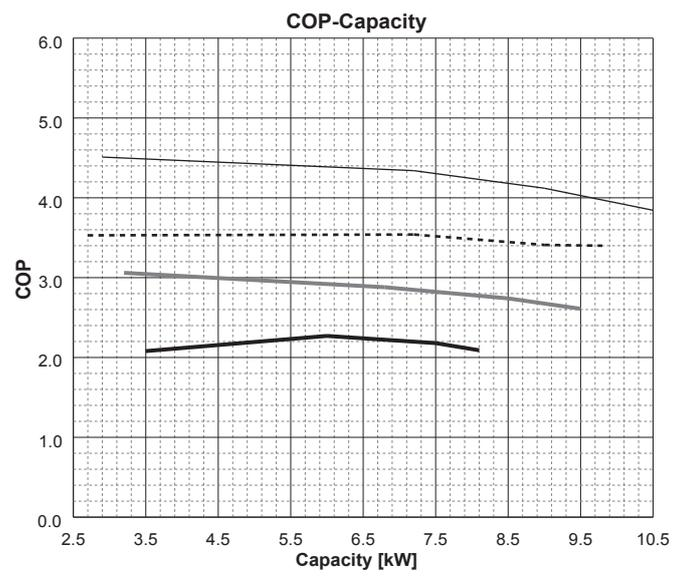
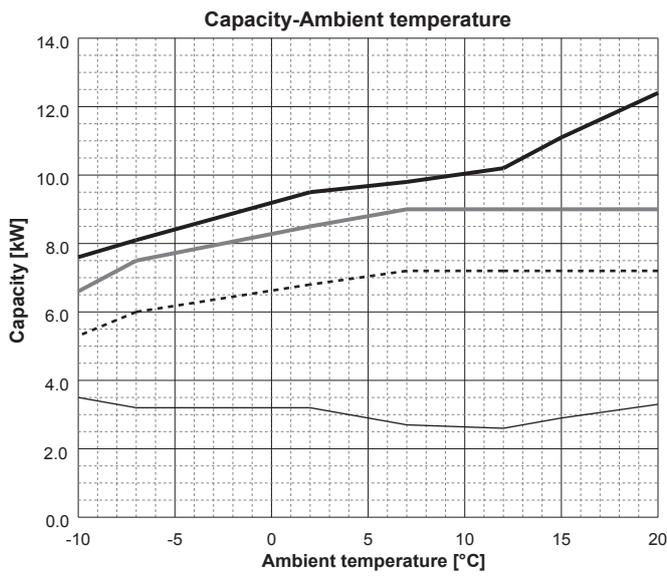

Water outlet temperature 55 [°C]

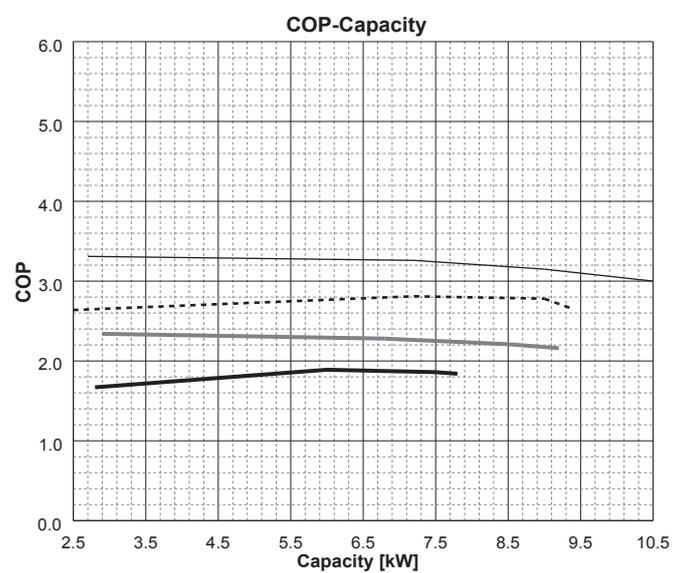
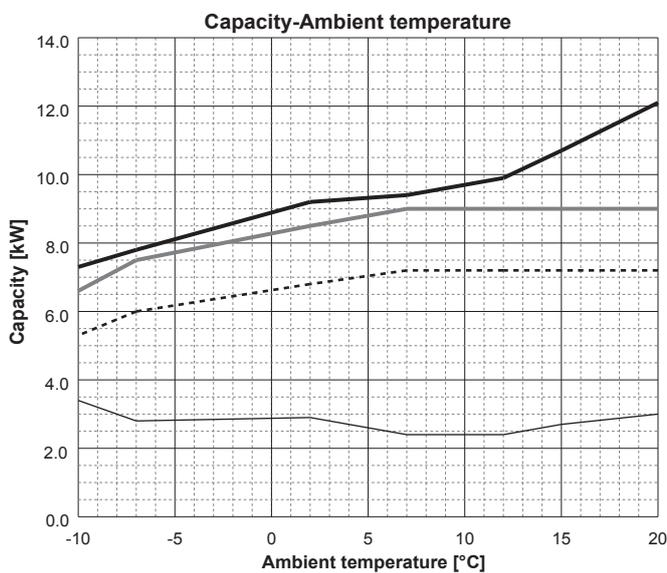

PUHZ-W112V/YAA

■ Water outlet temperature 35 [°C]

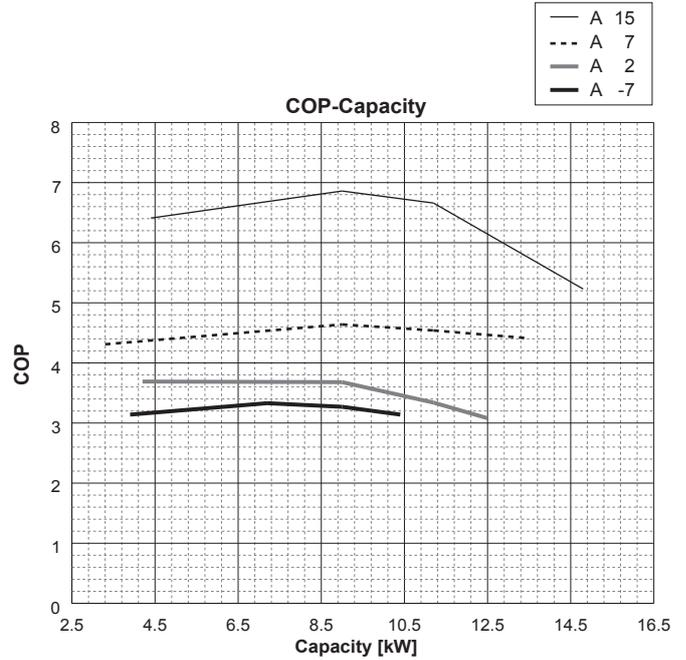
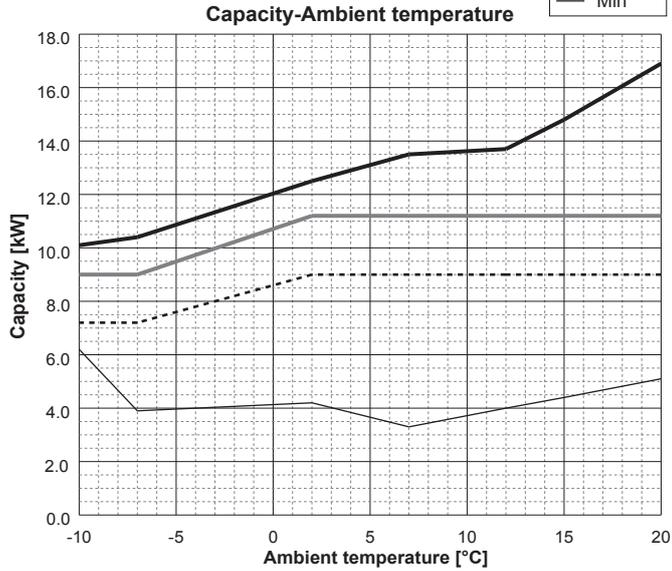

■ Water outlet temperature 45 [°C]

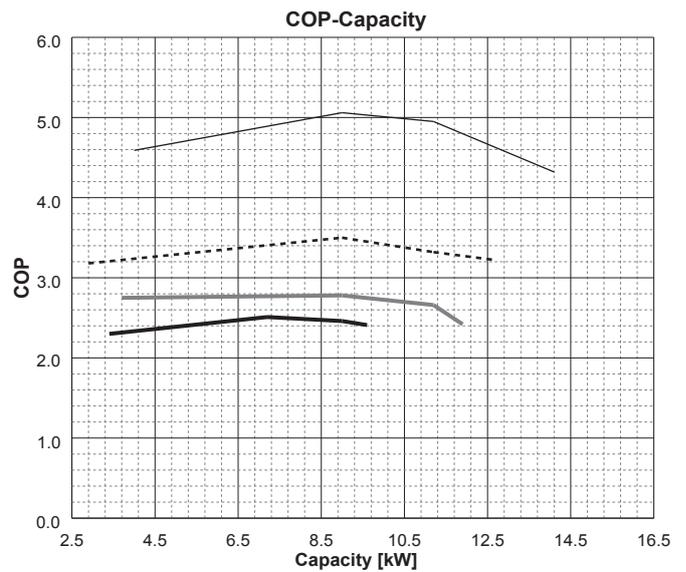
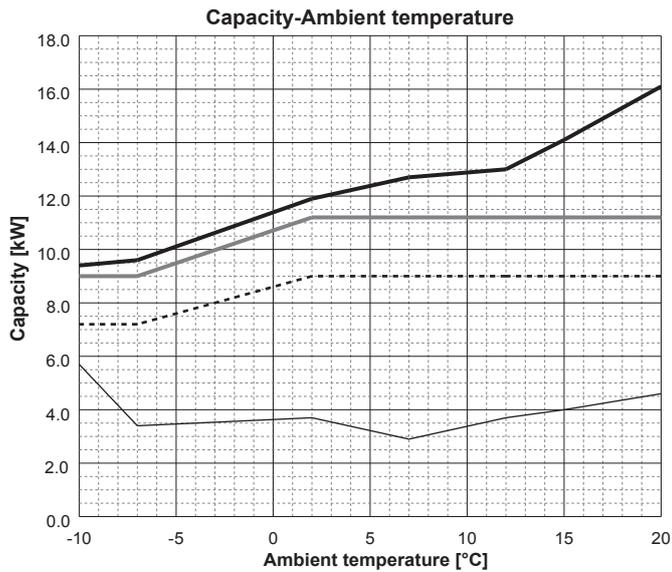

■ Water outlet temperature 55 [°C]

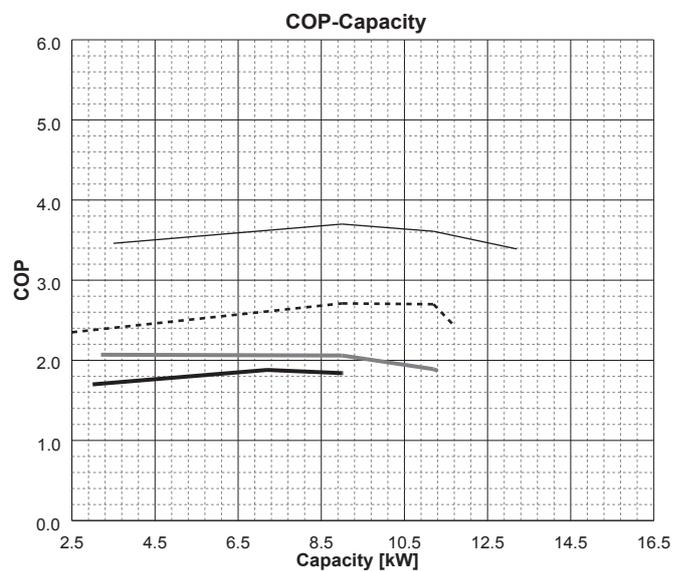
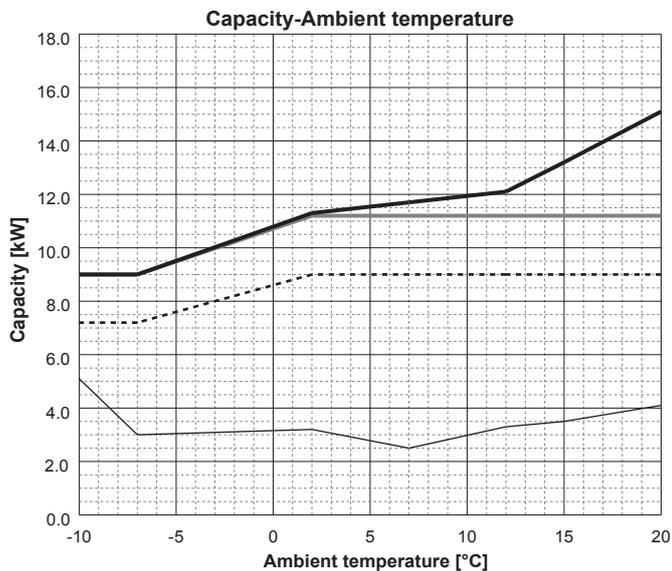

PUHZ-HW112YHA2(-BS)

Water outlet temperature 35 [°C]

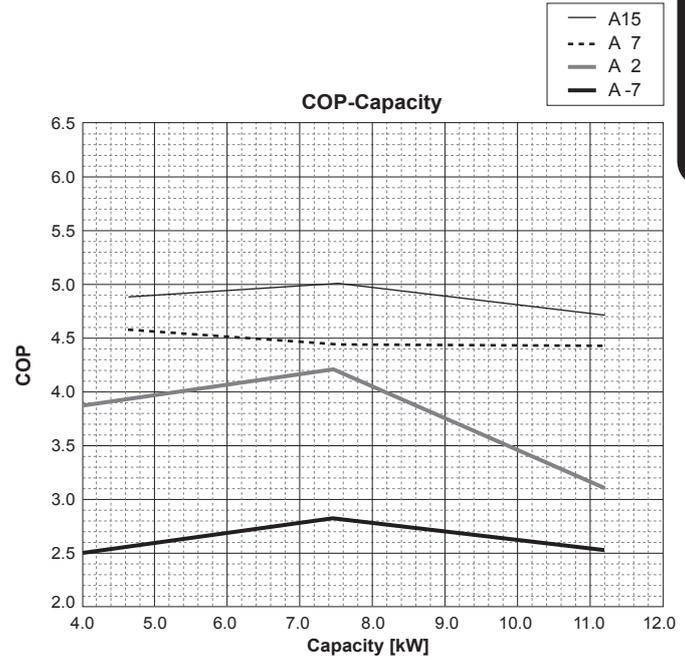
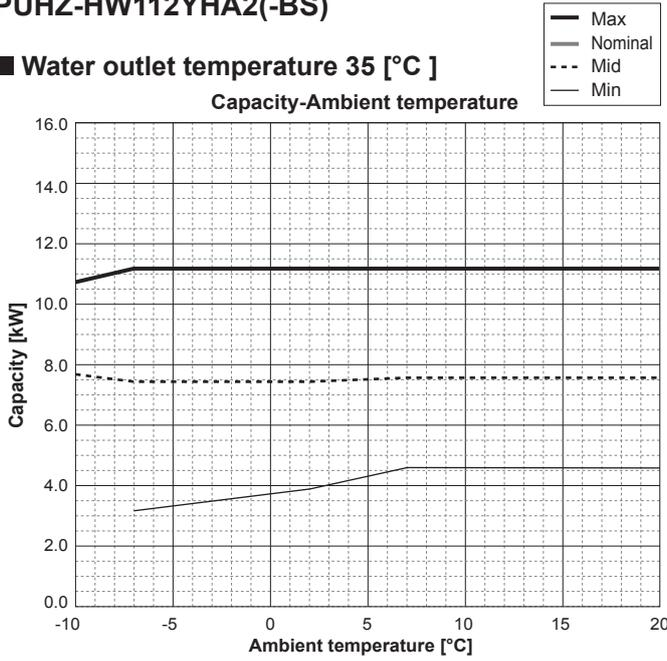

Water outlet temperature 45 [°C]

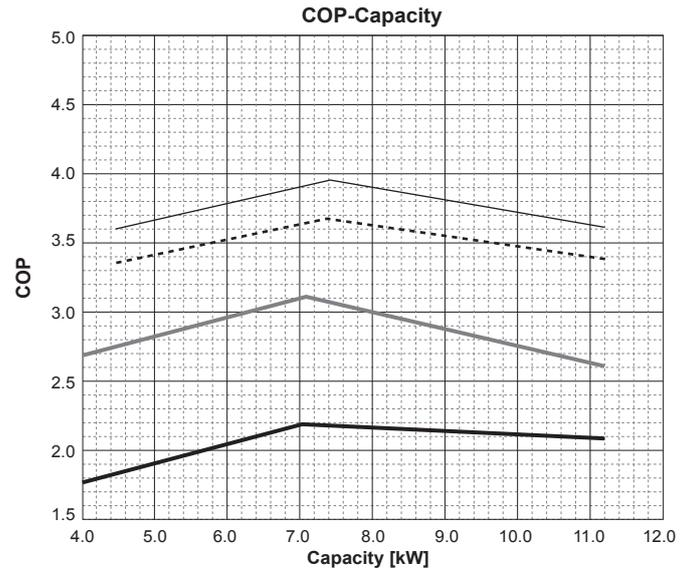
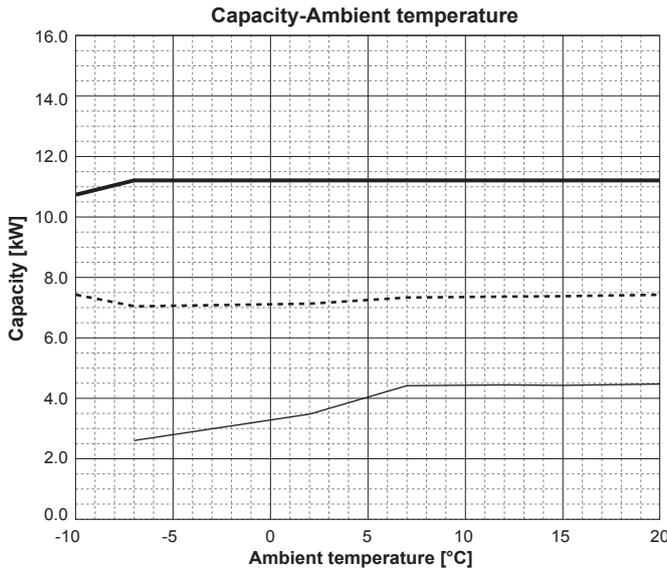

Water outlet temperature 55 [°C]

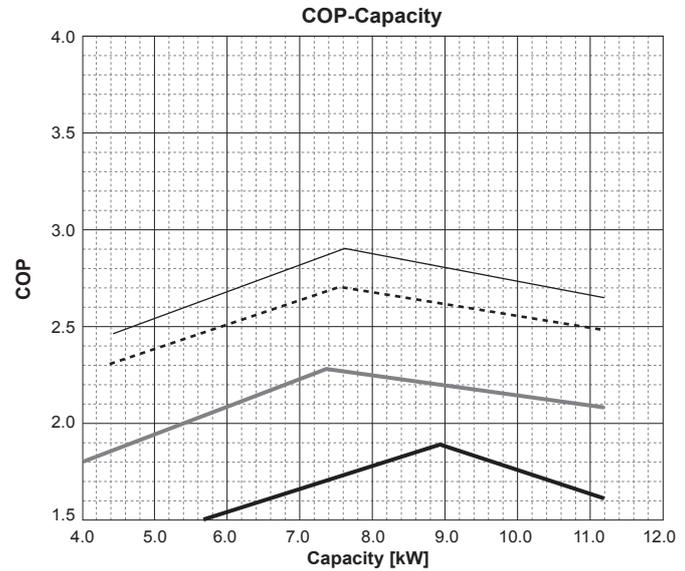
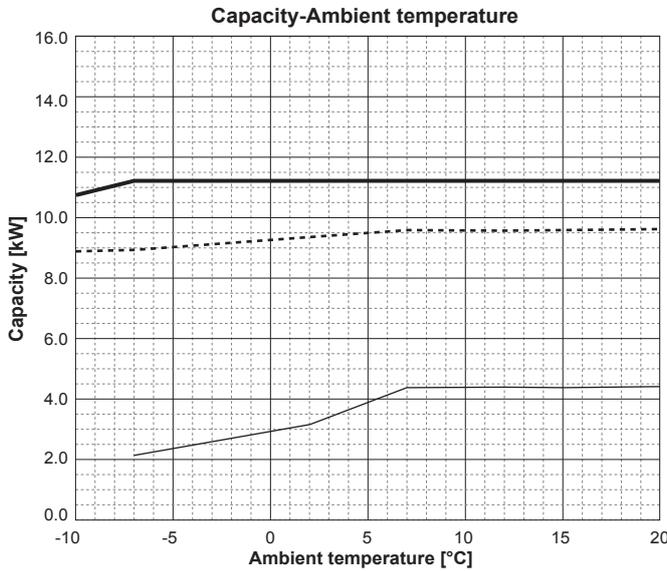

Outdoor unit

PUHZ-HW140V/YHA2(-BS)

■ Water outlet temperature 35 [°C]

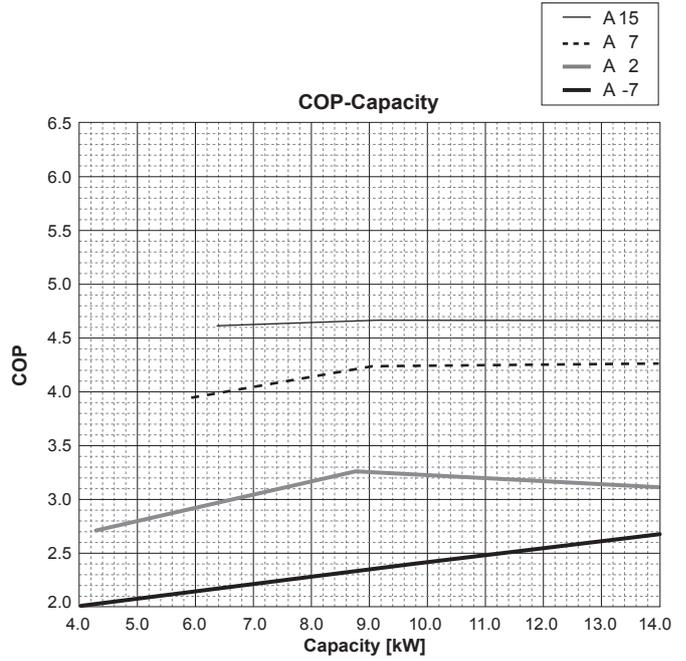
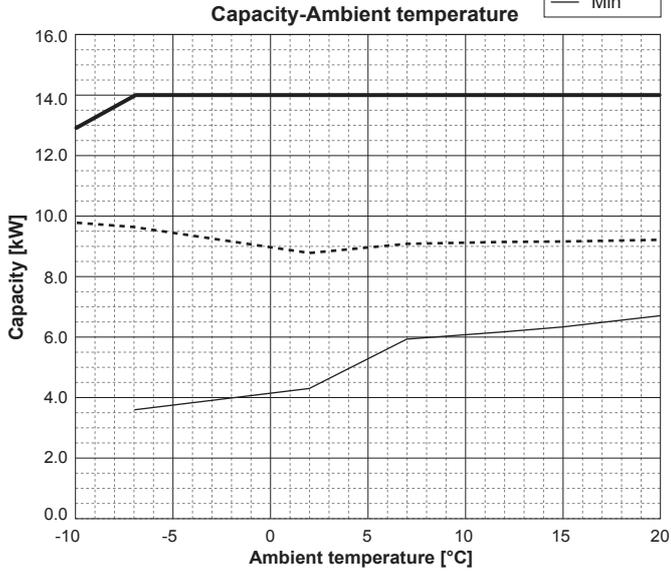

■ Water outlet temperature 45 [°C]

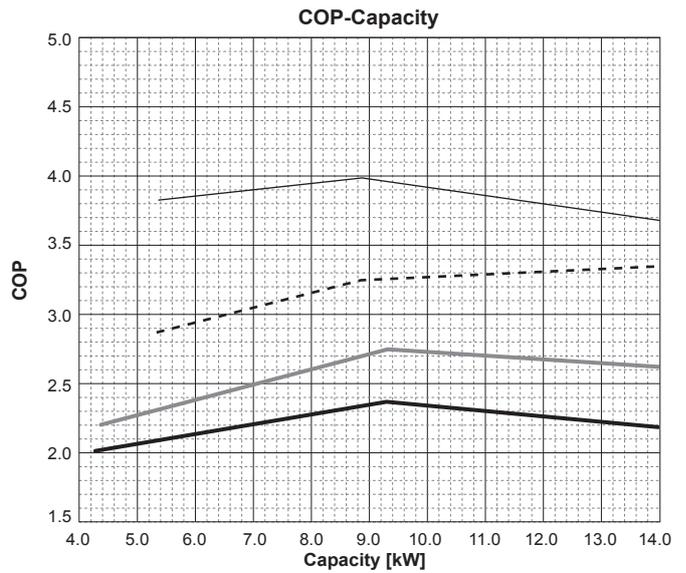
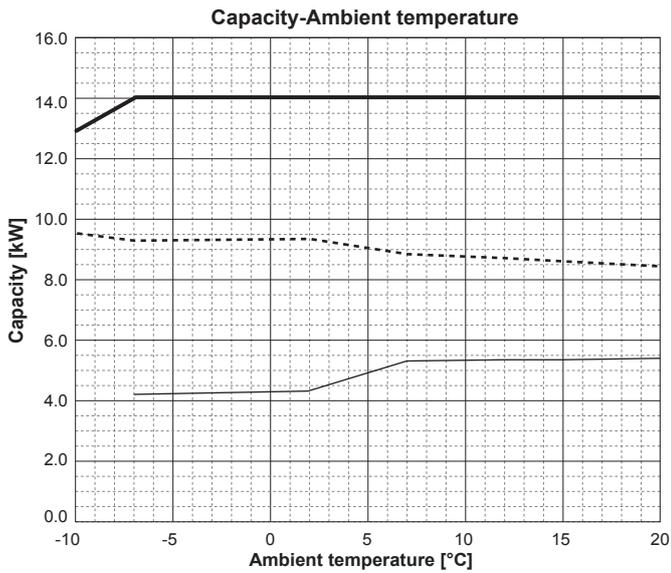

■ Water outlet temperature 55 [°C]

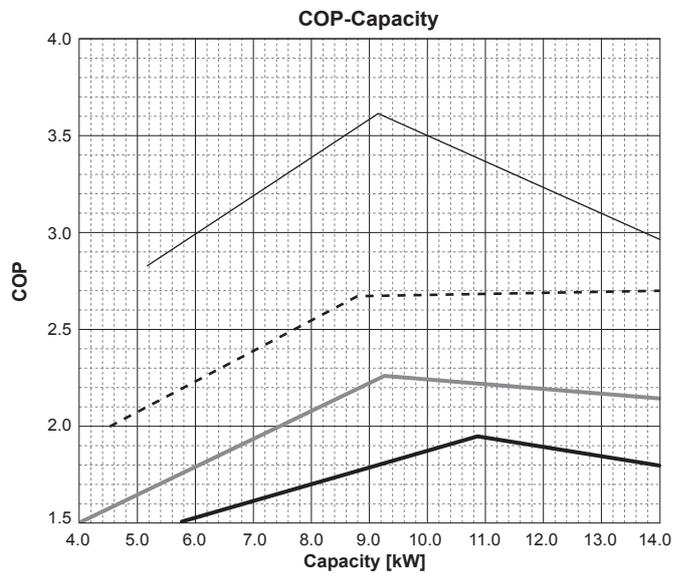
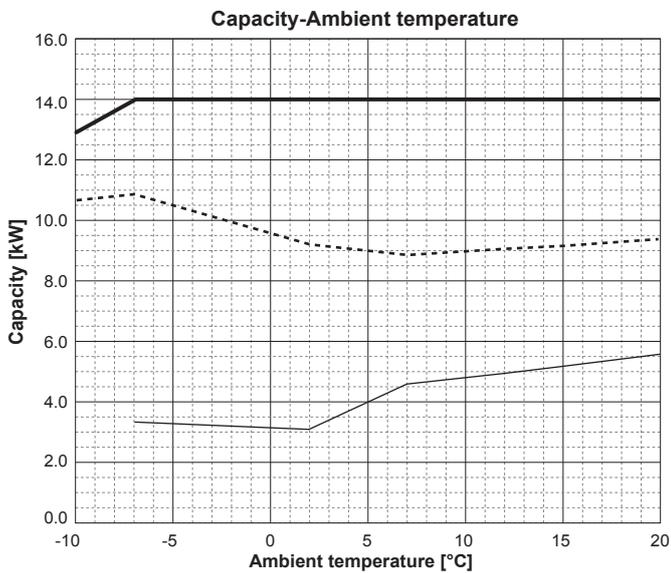

SUHZ-SW45VA

Water outlet temperature 35 [°C]

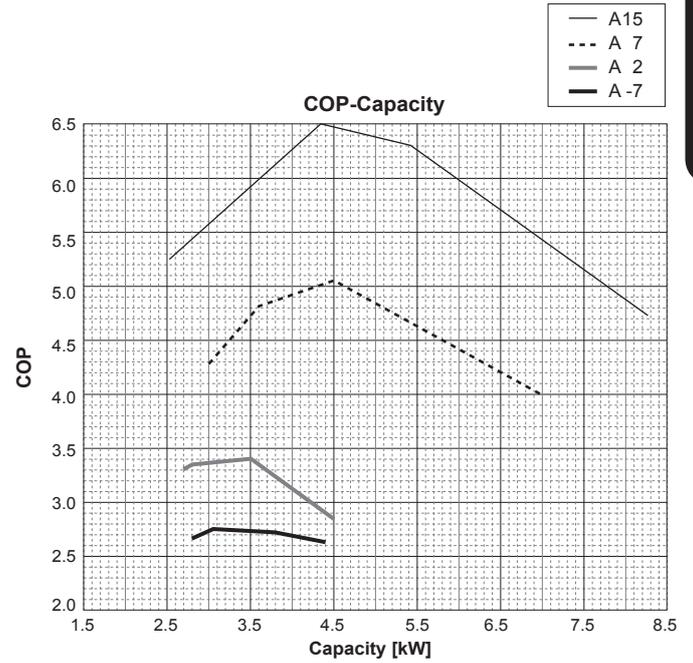
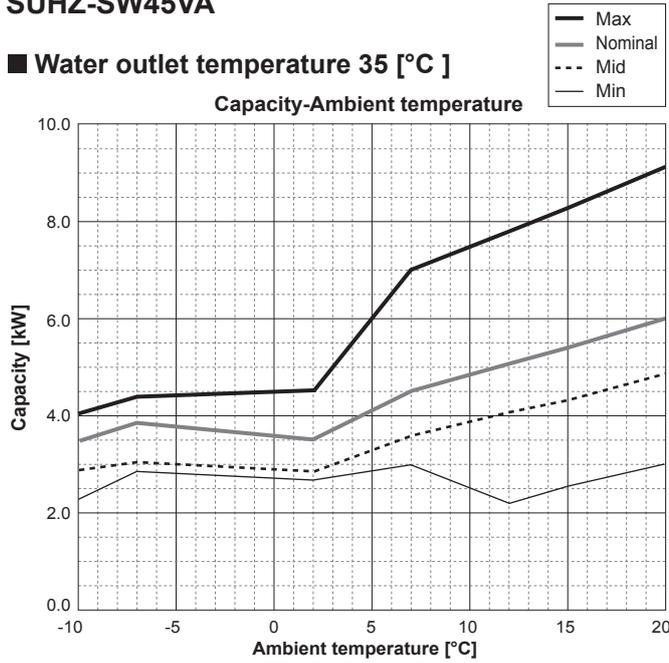

Water outlet temperature 45 [°C]

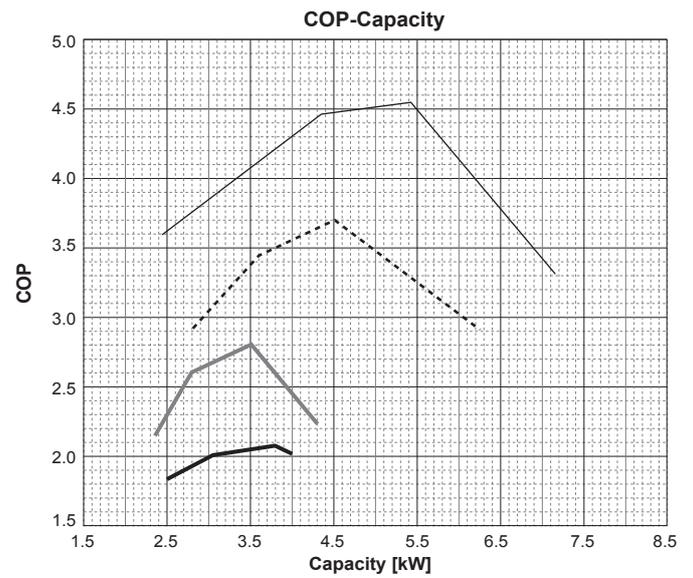
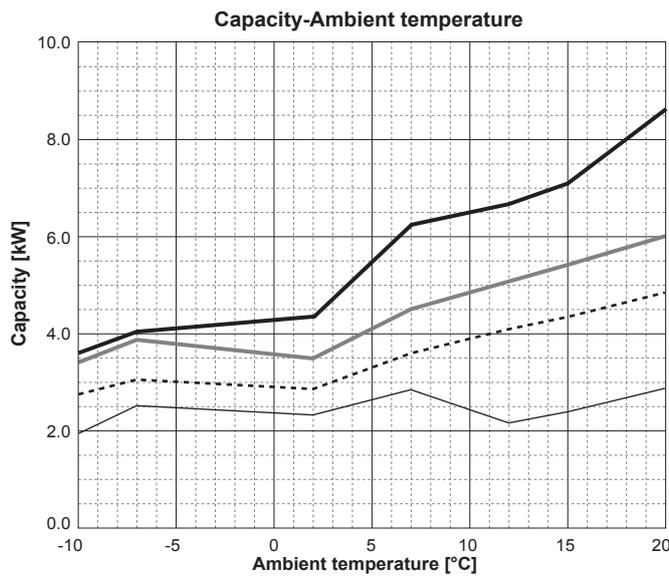

Water outlet temperature 55 [°C]

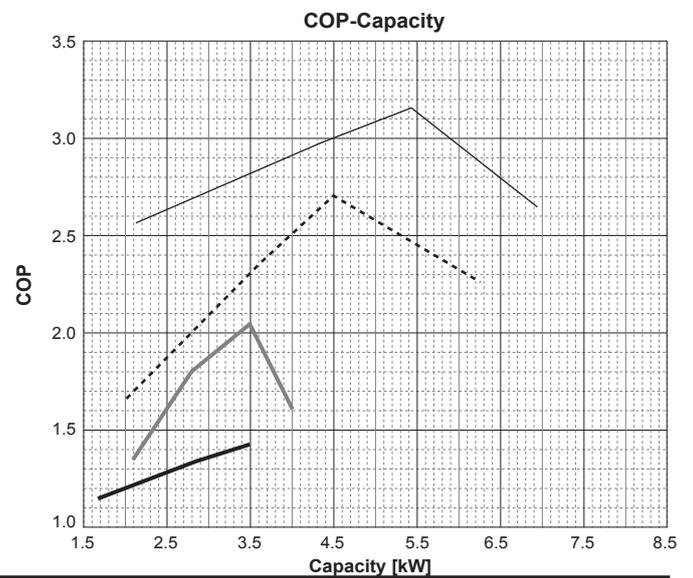
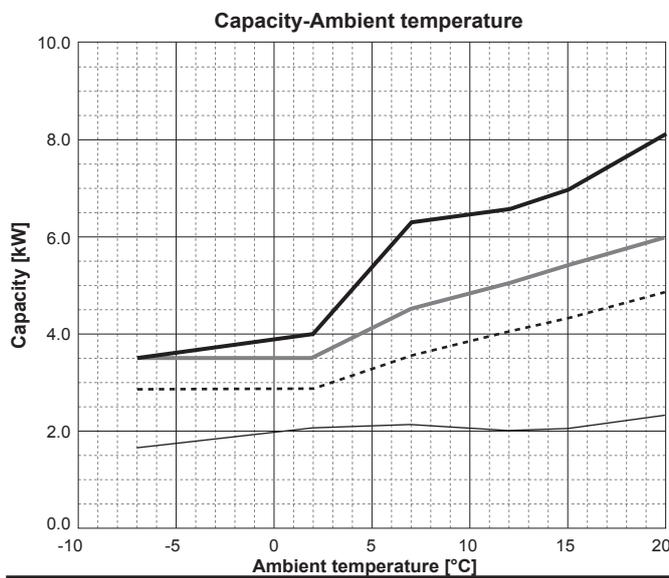

Outdoor unit

SUHZ-SW45VAH

Water outlet temperature 35 [°C]

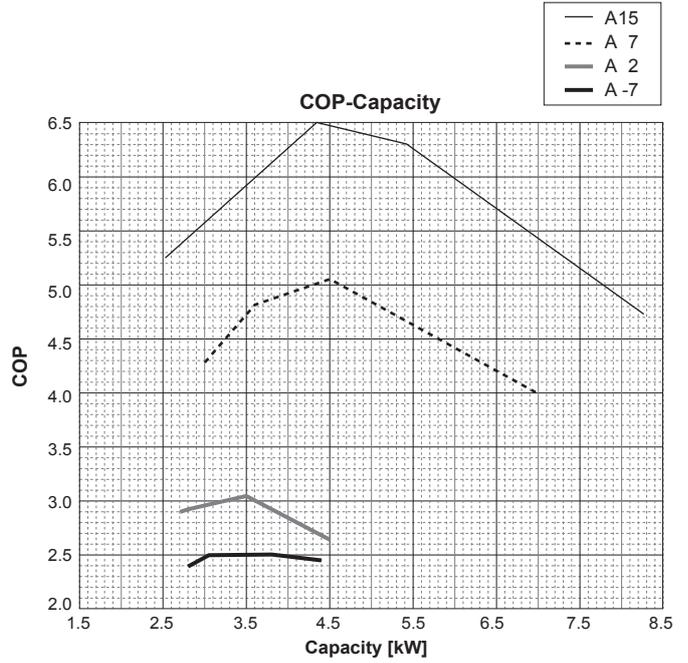
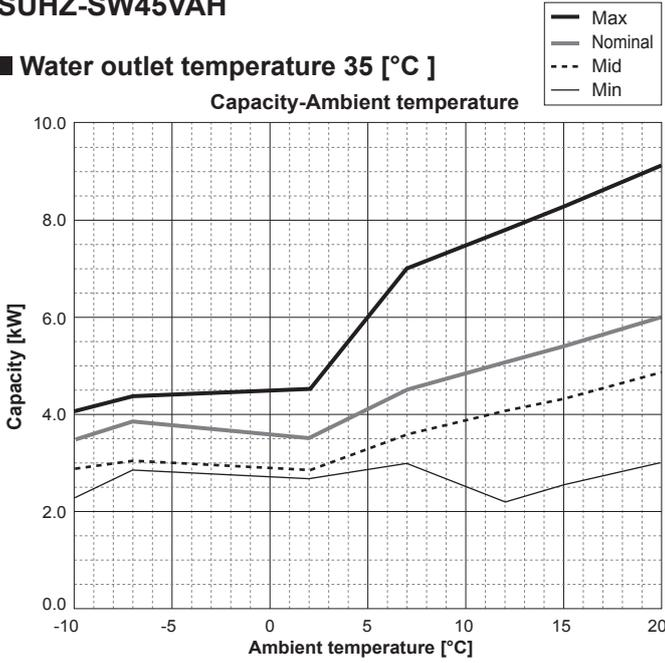

Water outlet temperature 45 [°C]

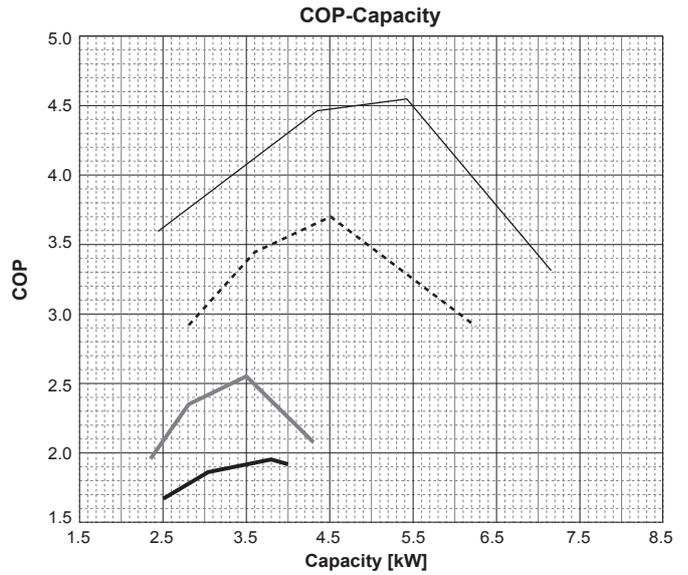
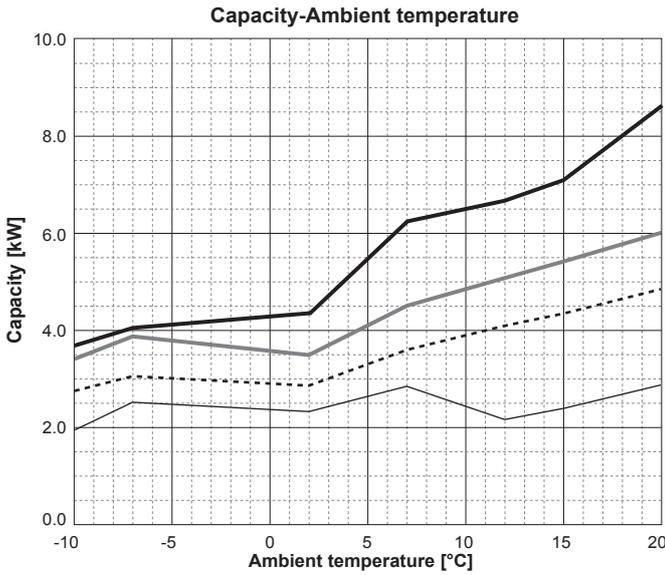

Water outlet temperature 55 [°C]

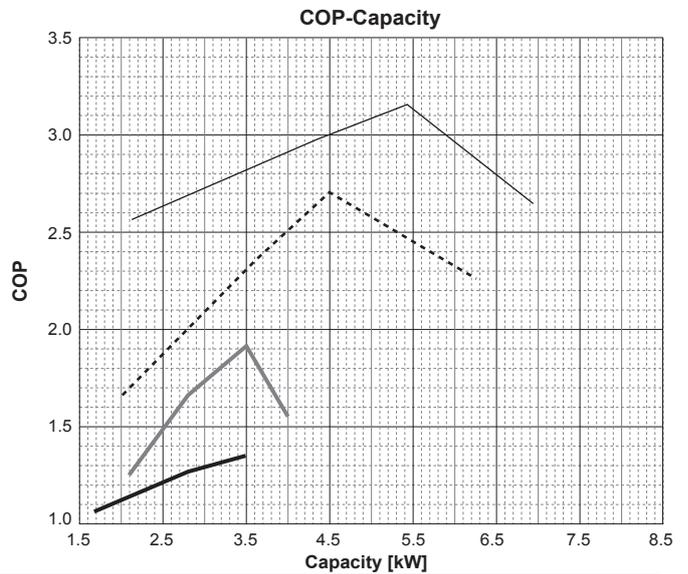
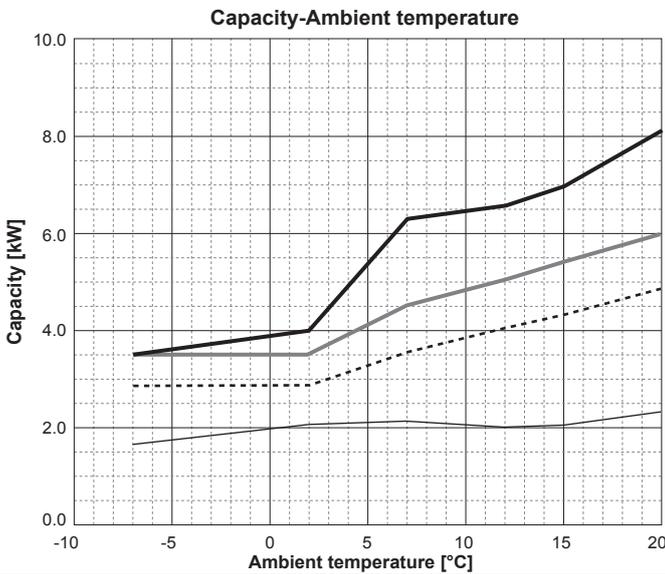

PUHZ-SW50VKA(-BS)

Water outlet temperature 35 [°C]

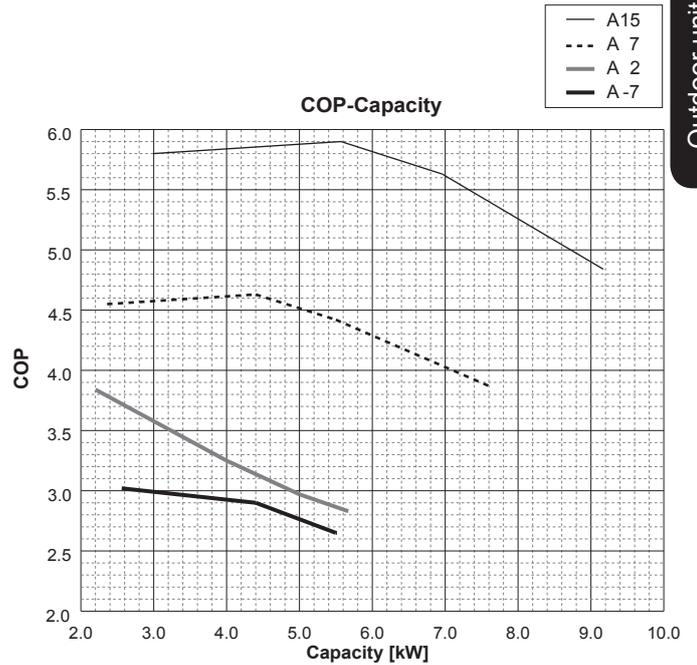
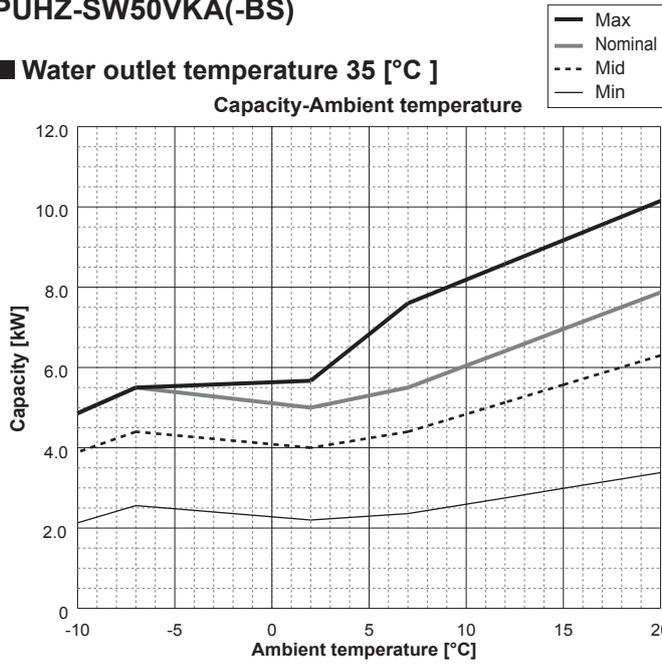

Water outlet temperature 45 [°C]

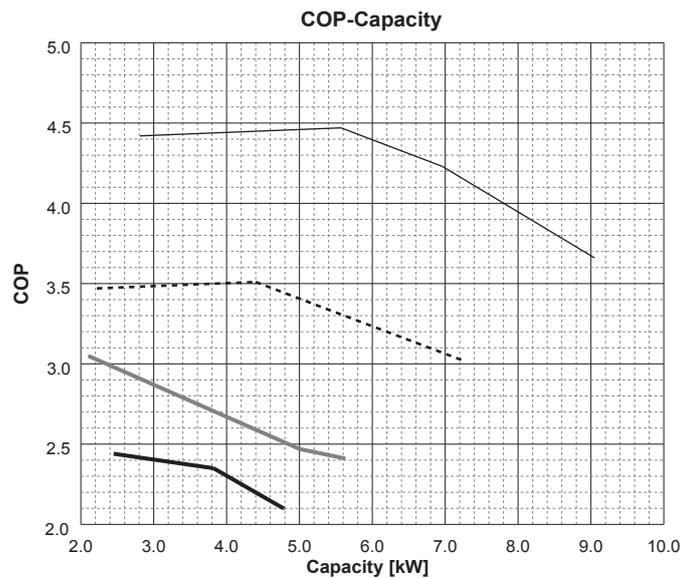
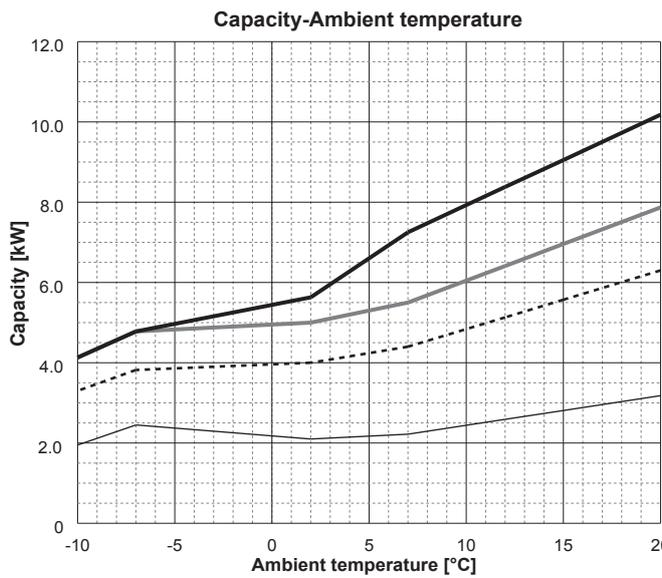

Water outlet temperature 55 [°C]

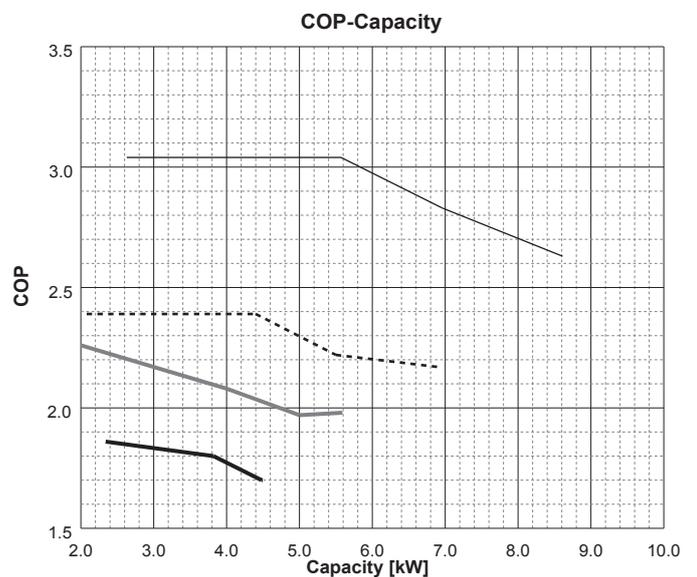
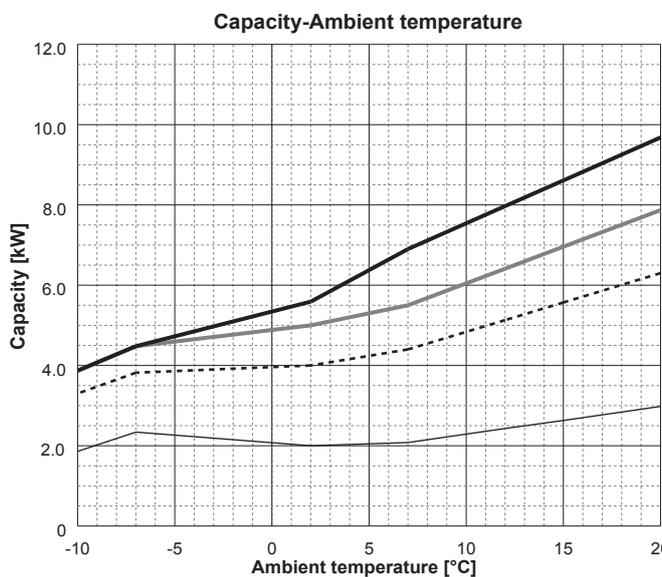

PUHZ-SW75VHA(-BS)

■ Water outlet temperature 35 [°C]

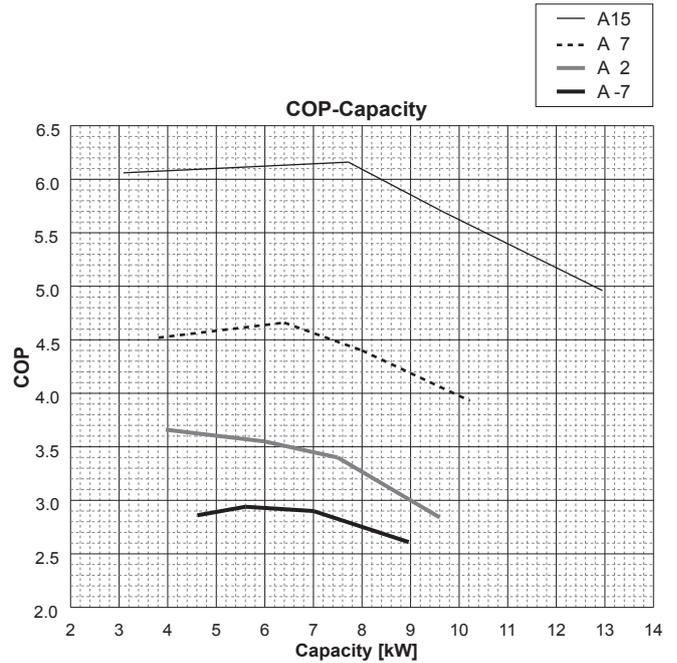
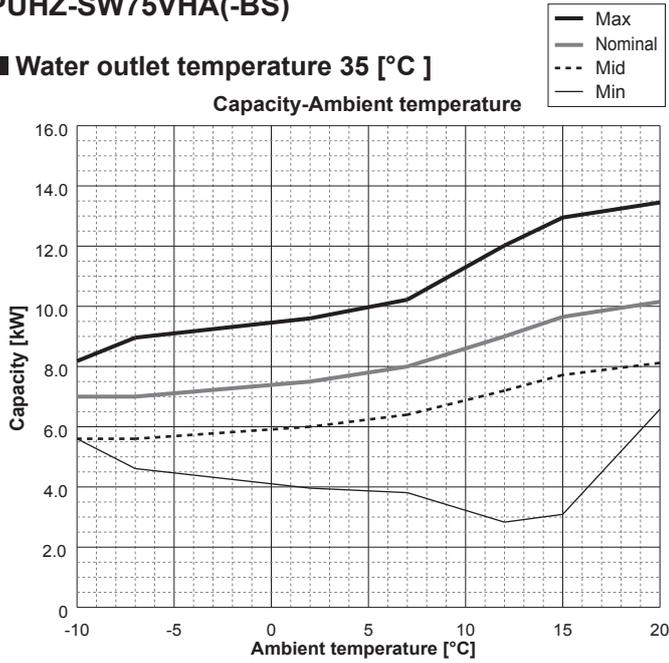

■ Water outlet temperature 45 [°C]

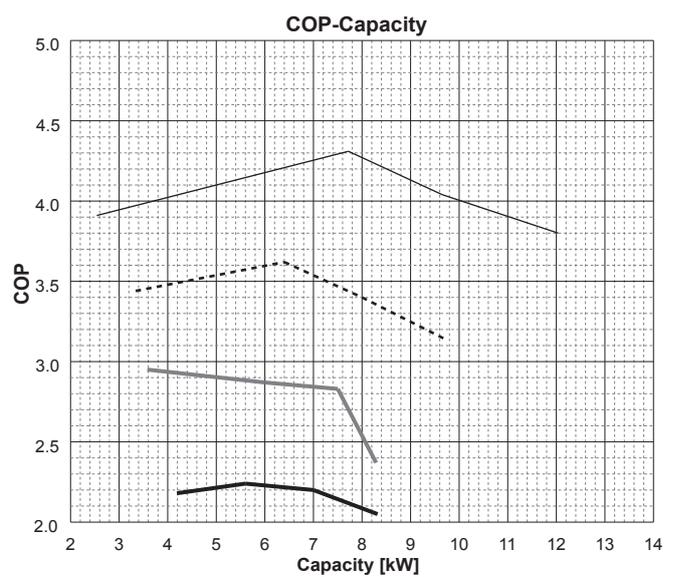
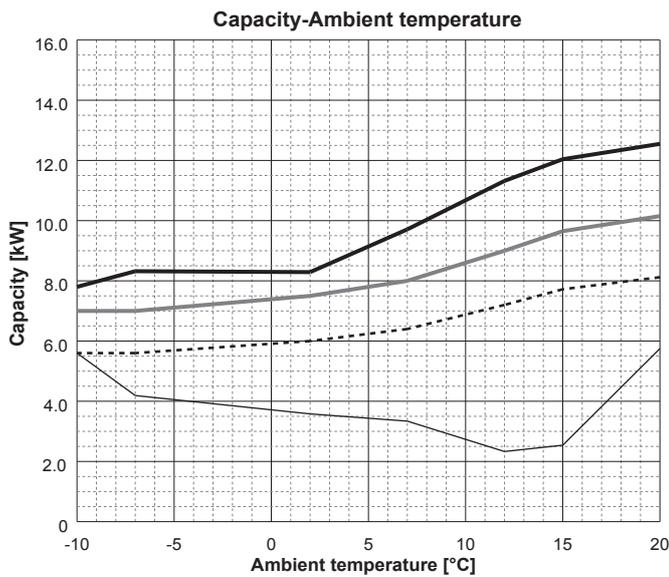

■ Water outlet temperature 55 [°C]

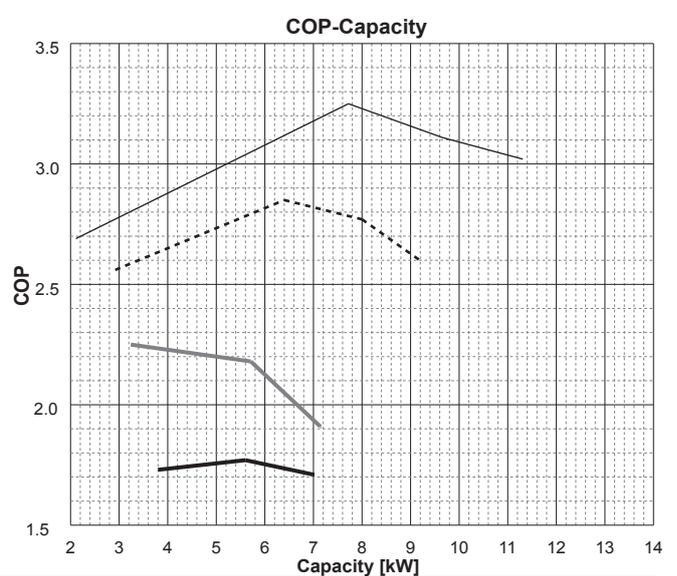
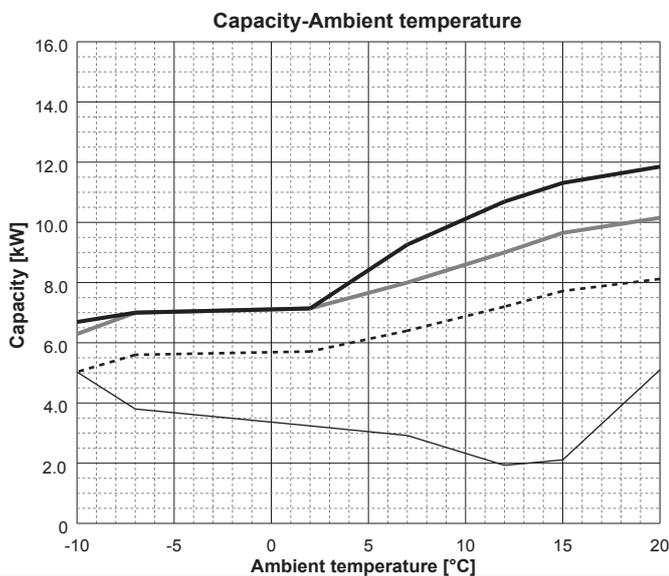

PUHZ-SW100V/YHA(-BS)

Water outlet temperature 35 [°C]

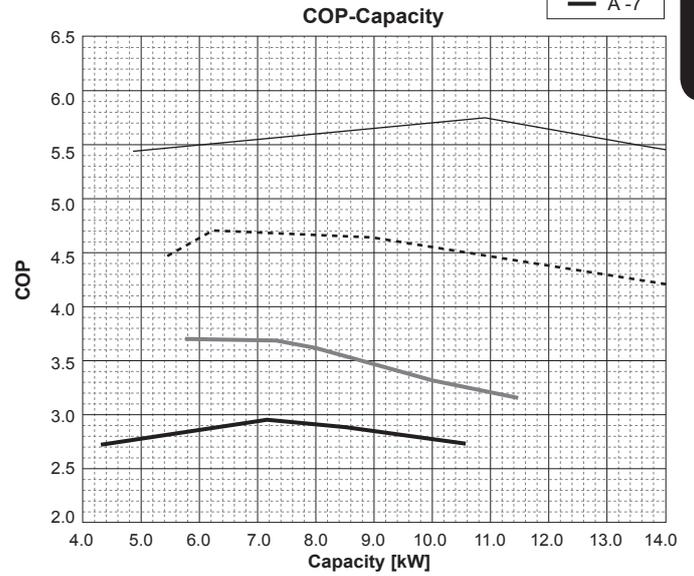
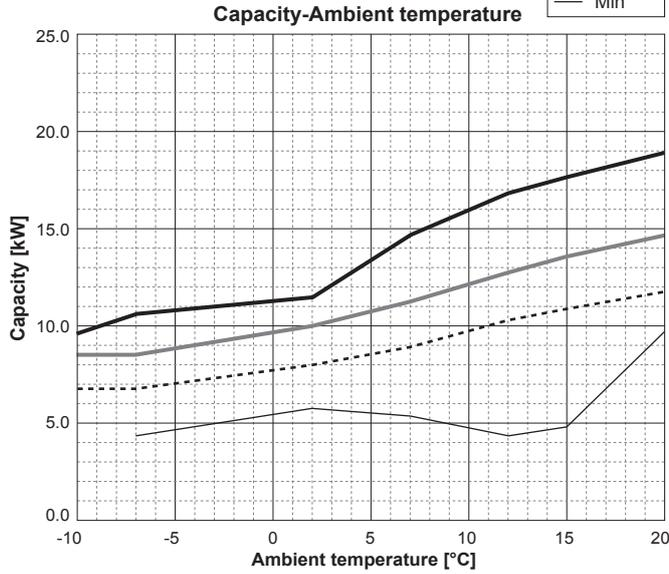

Water outlet temperature 45 [°C]

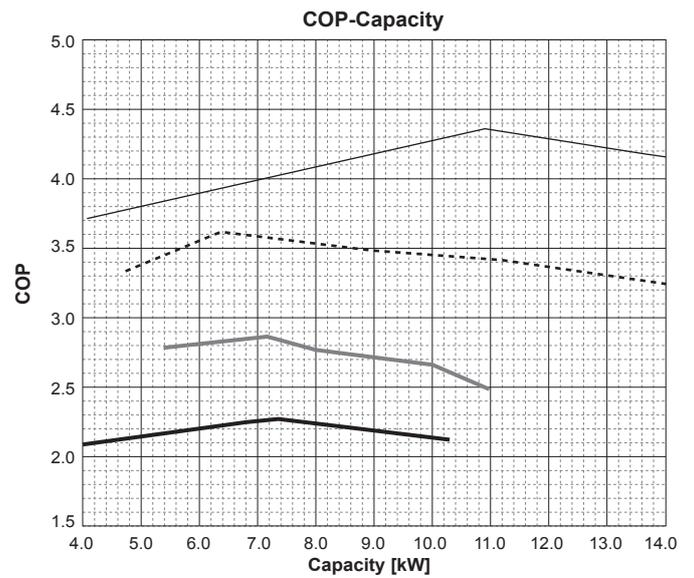
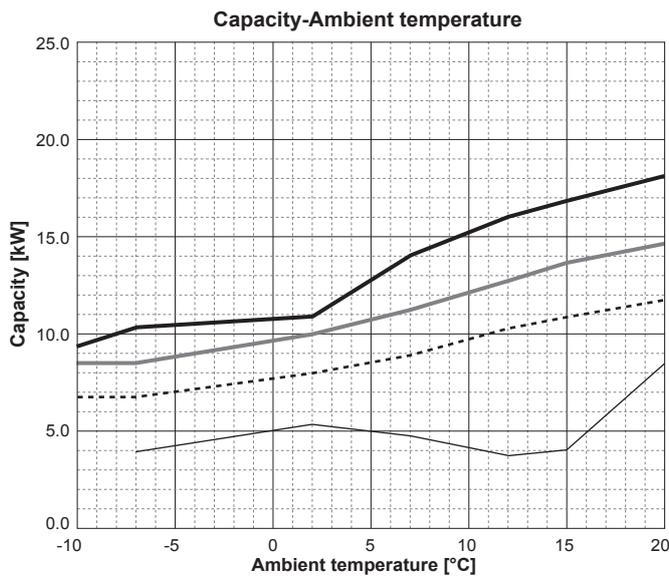

Water outlet temperature 55 [°C]

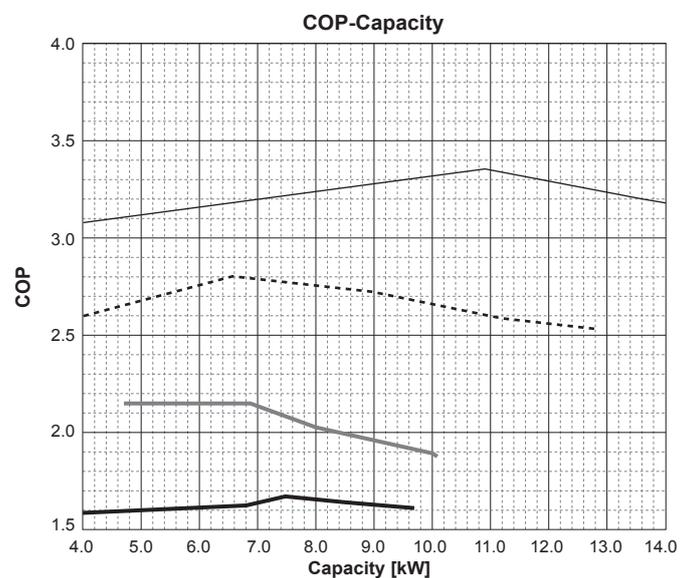
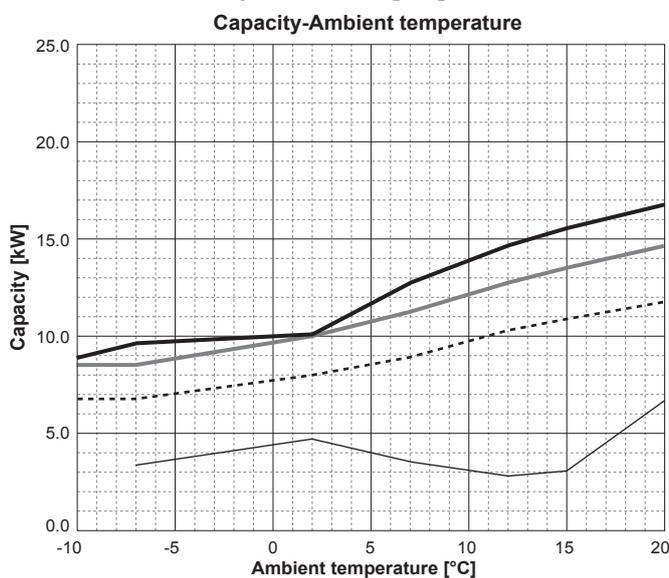

Outdoor unit

PUHZ-SW120V/YHA(-BS)

Water outlet temperature 35 [°C]

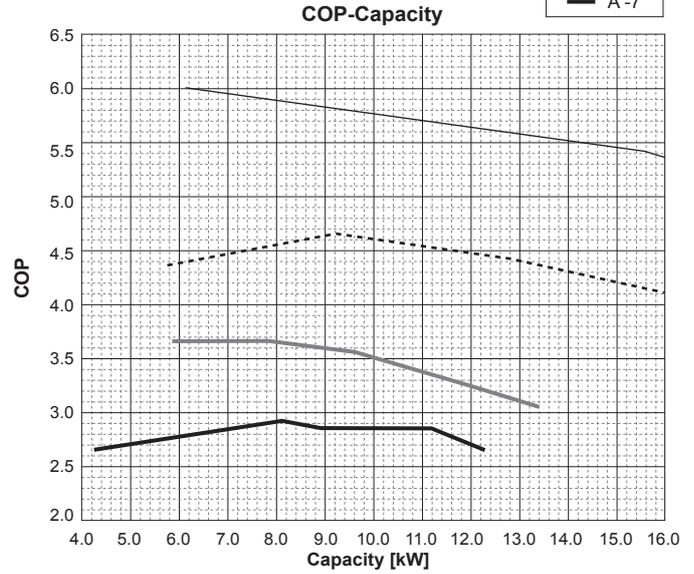
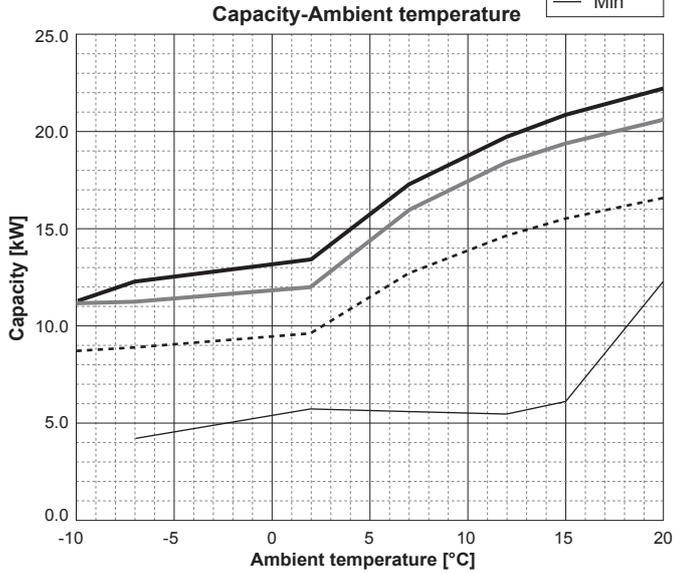

Water outlet temperature 45 [°C]

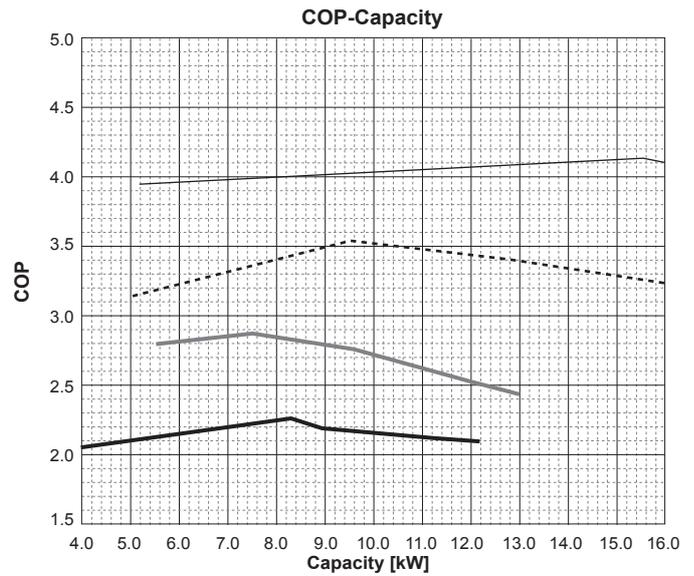
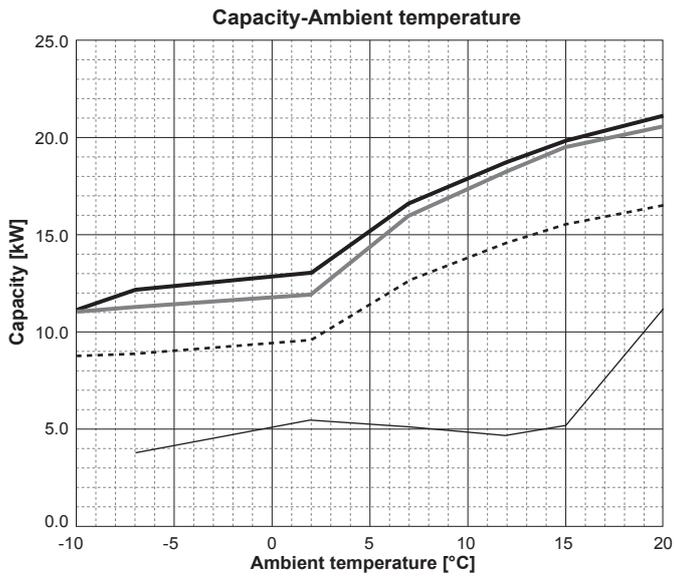

Water outlet temperature 55 [°C]

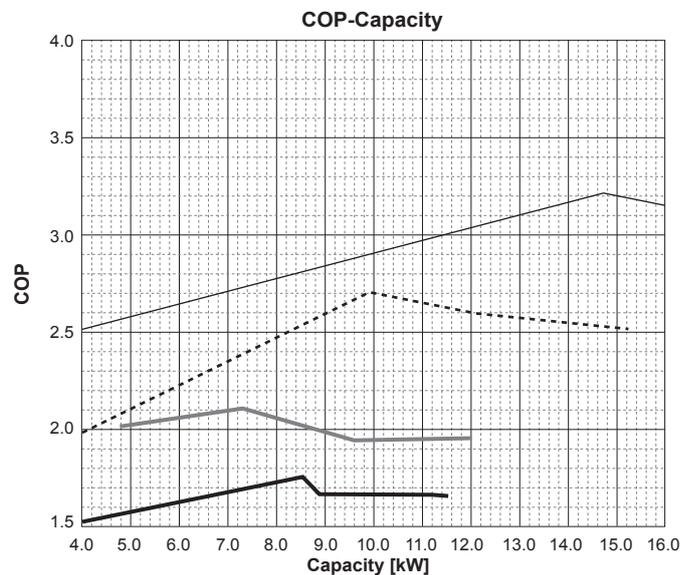
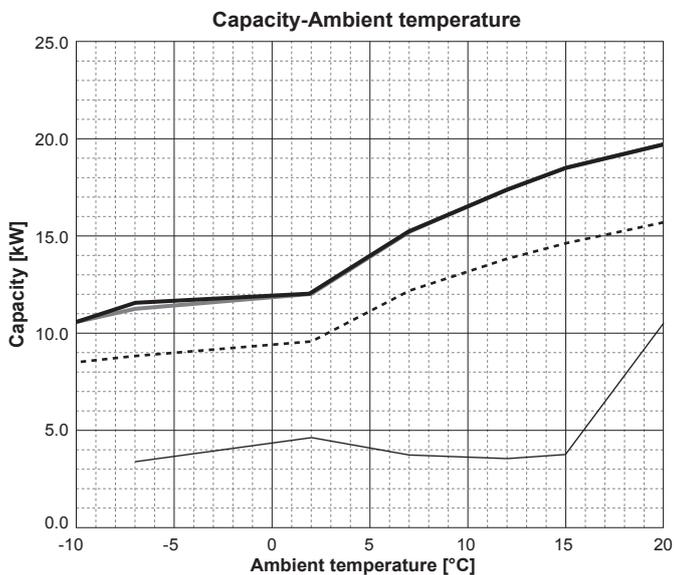

PUHZ-SW160YKA(-BS)

Water outlet temperature 35 [°C]

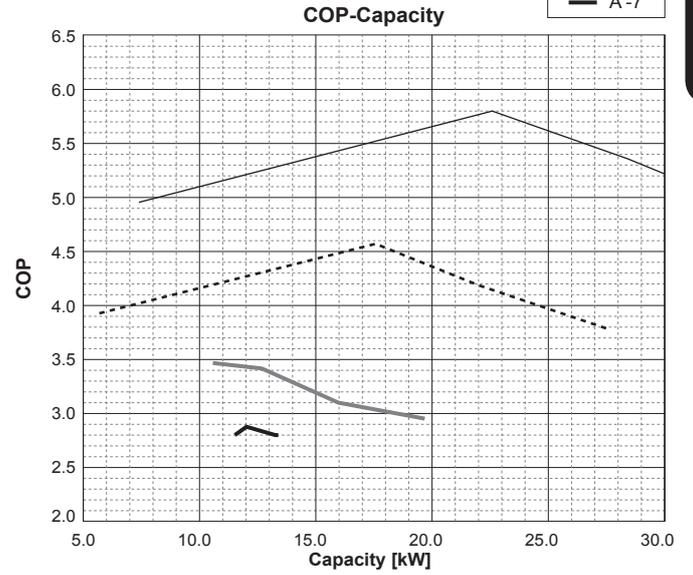
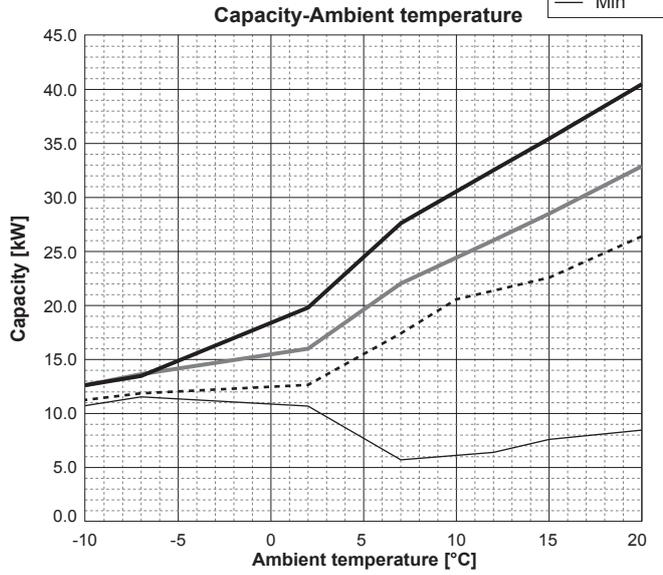

Water outlet temperature 45 [°C]

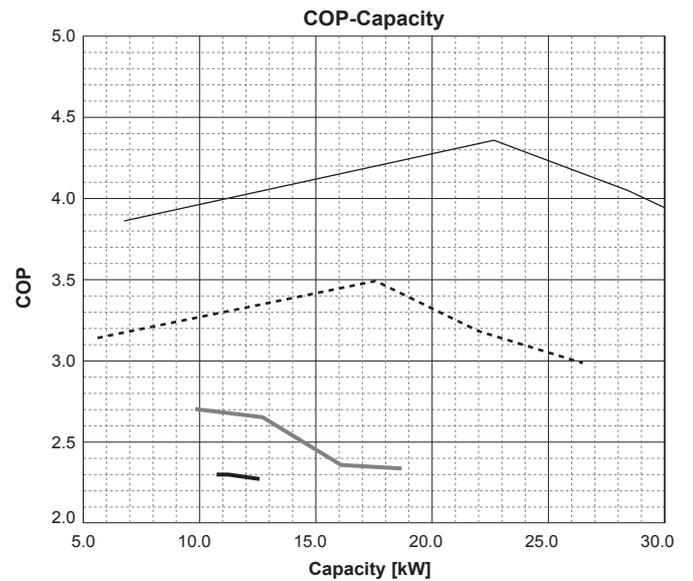
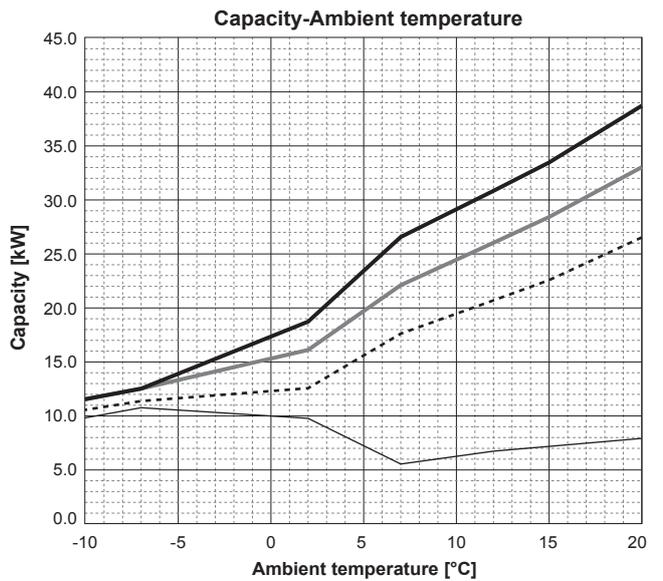

Water outlet temperature 55 [°C]

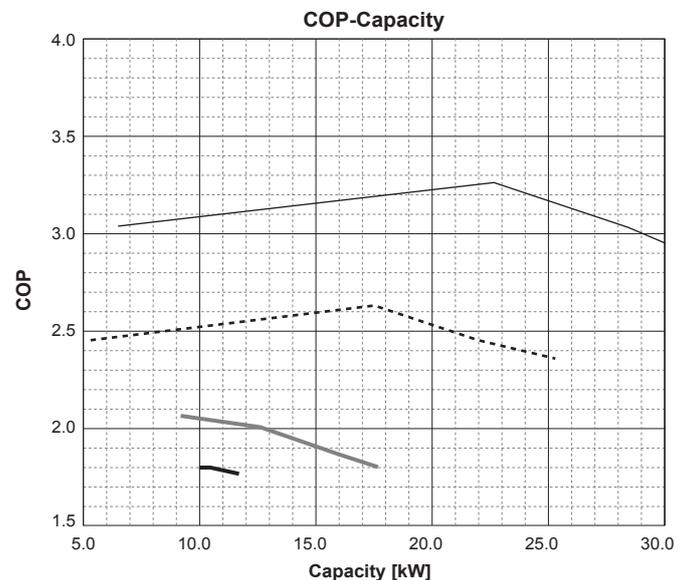
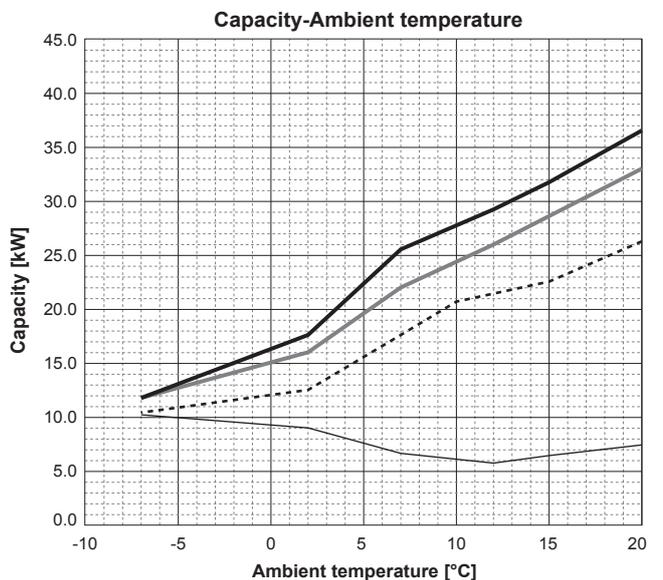

PUHZ-SW200YKA(-BS)

■ **Water outlet temperature 35 [°C]**

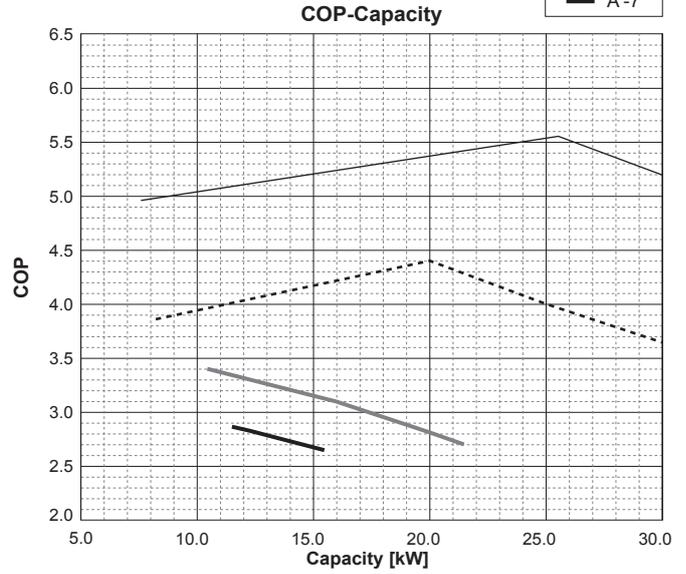
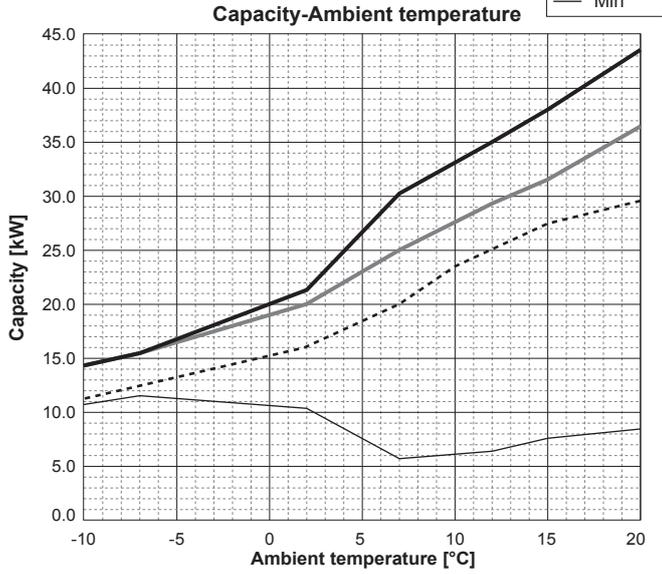

■ **Water outlet temperature 45 [°C]**

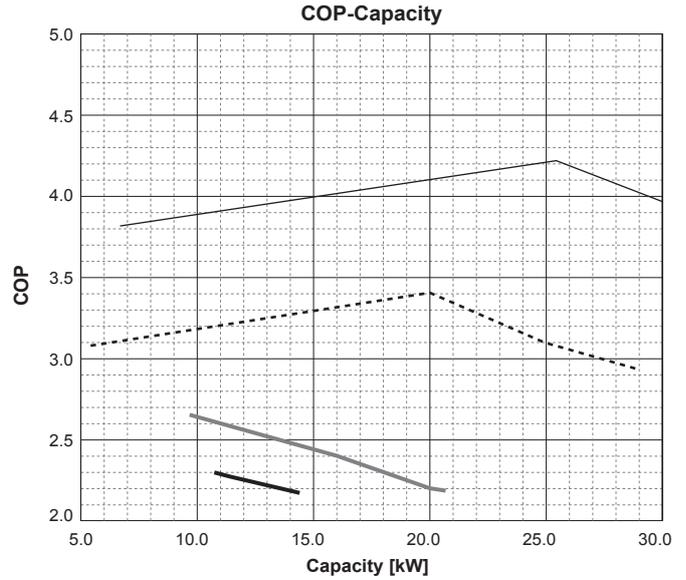
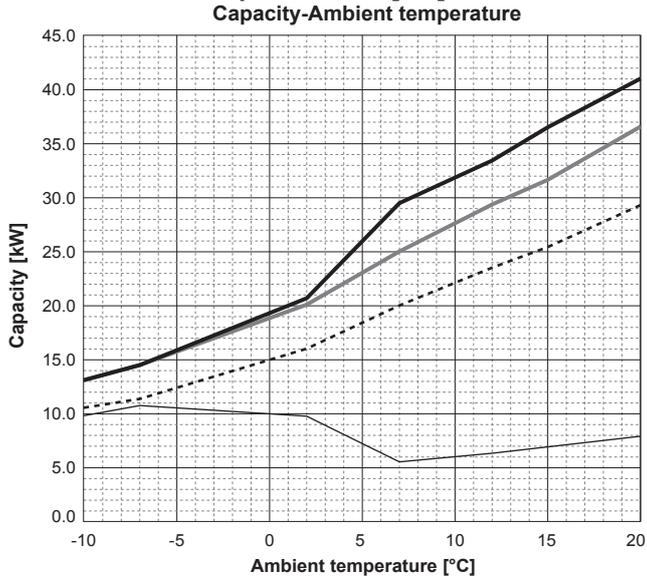

■ **Water outlet temperature 55 [°C]**

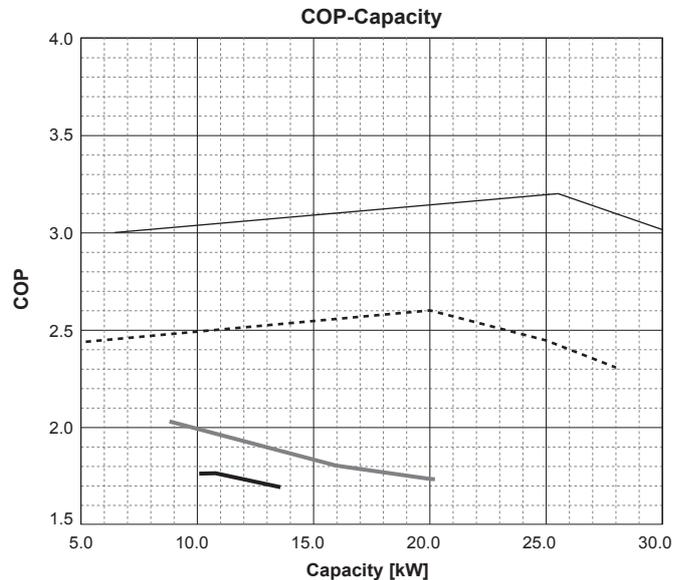
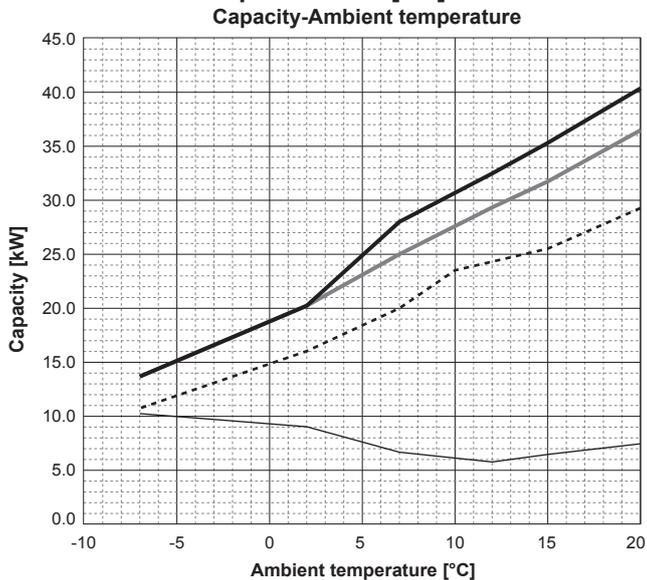

PUHZ-SW75V/YAA(-BS)

Water outlet temperature 35 [°C]

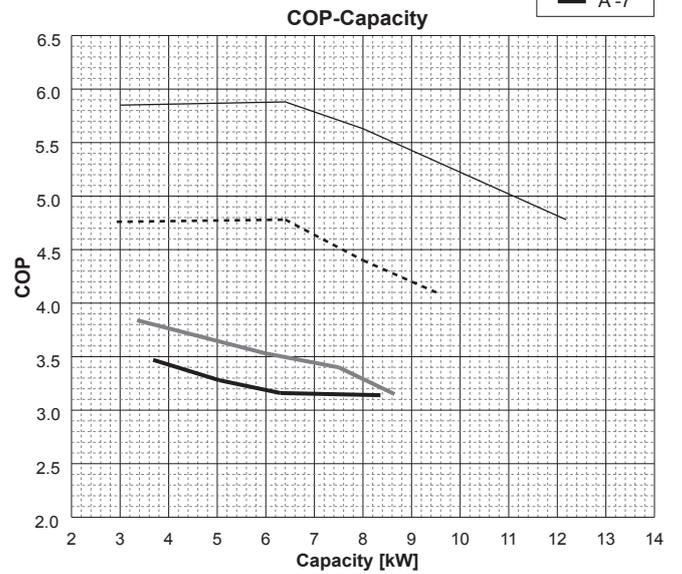
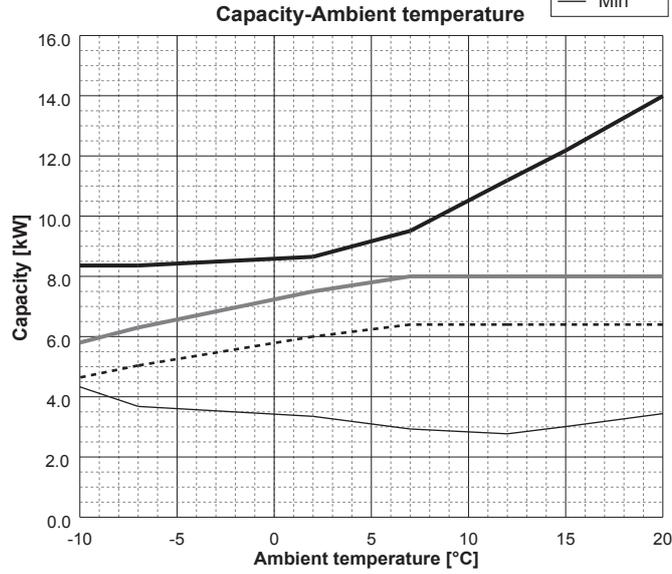

Water outlet temperature 45 [°C]

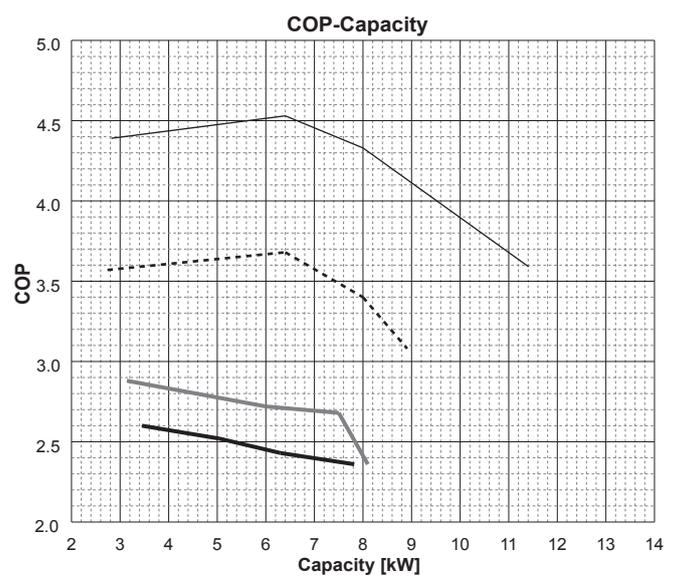
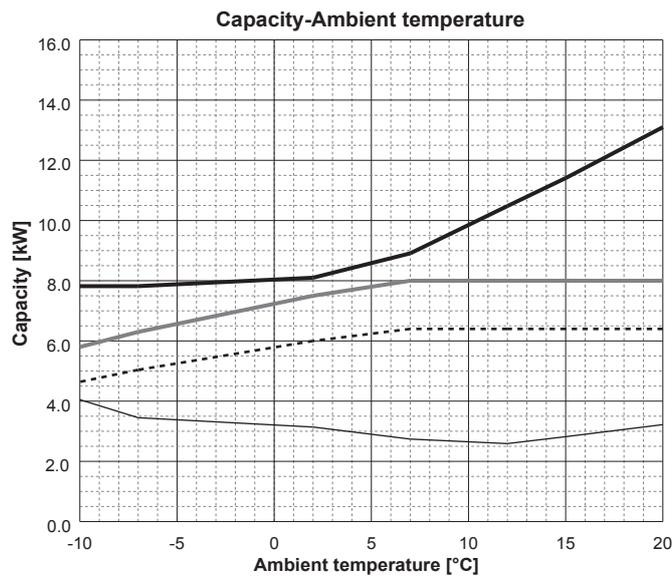

Water outlet temperature 55 [°C]

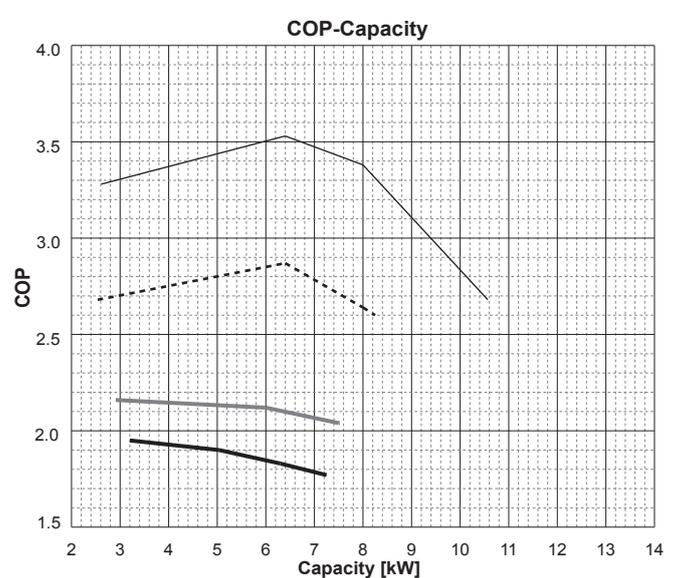
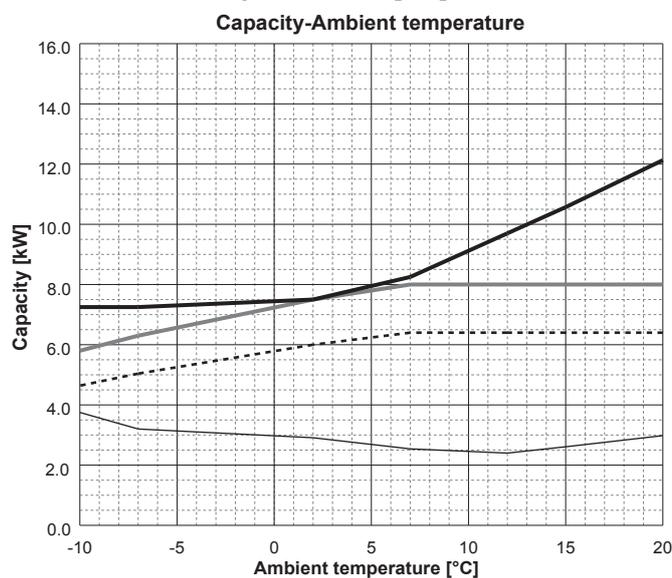

Outdoor unit

PUHZ-SW100V/YAA(-BS)

■ Water outlet temperature 35 [°C]

Capacity-Ambient temperature

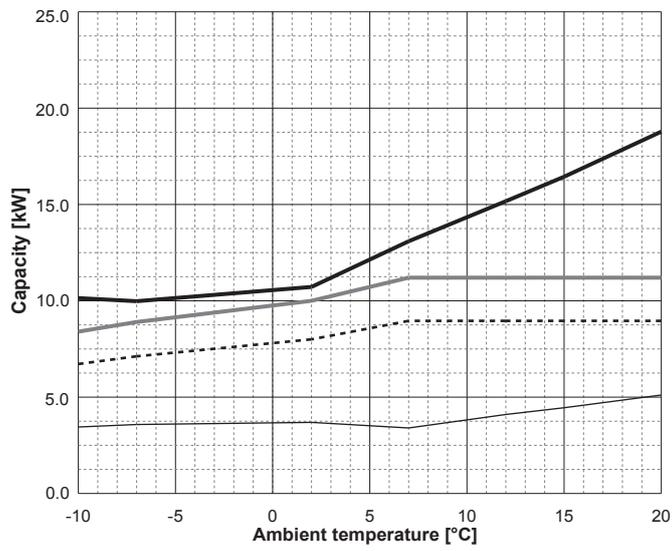

■ Water outlet temperature 45 [°C]

Capacity-Ambient temperature

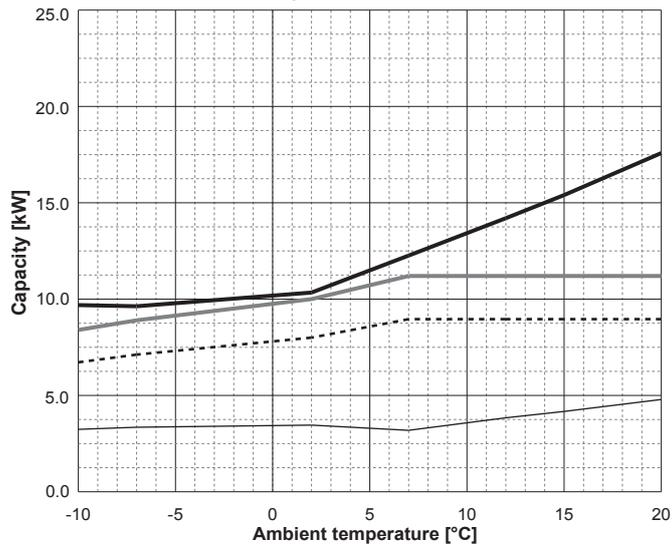

COP-Capacity

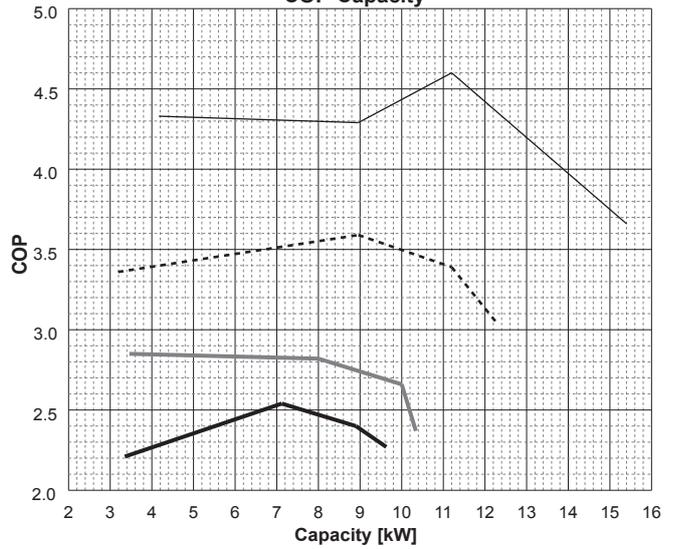

■ Water outlet temperature 55 [°C]

Capacity-Ambient temperature

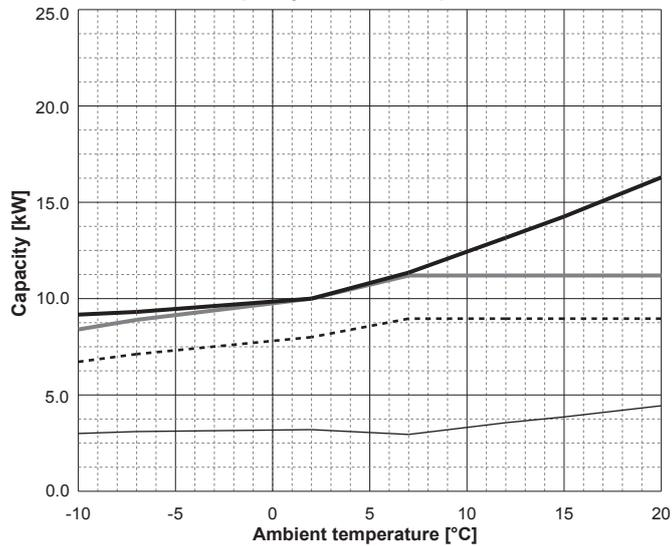

COP-Capacity

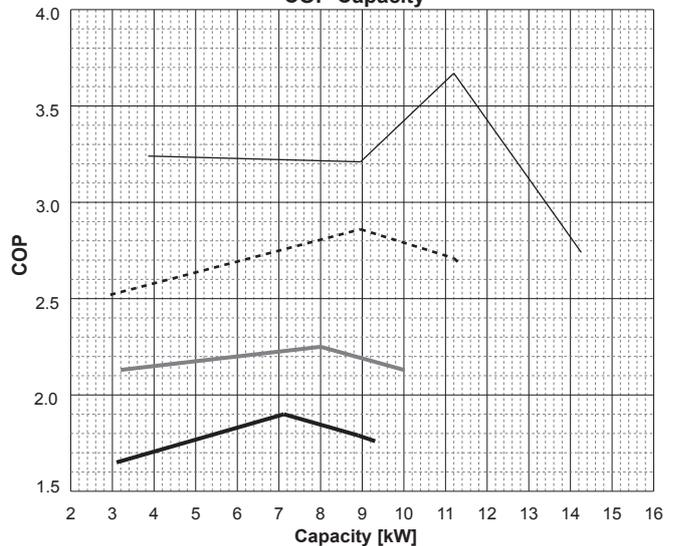

PUHZ-FRP71VHA2

Water outlet temperature 35 [°C]

Capacity-Ambient temperature

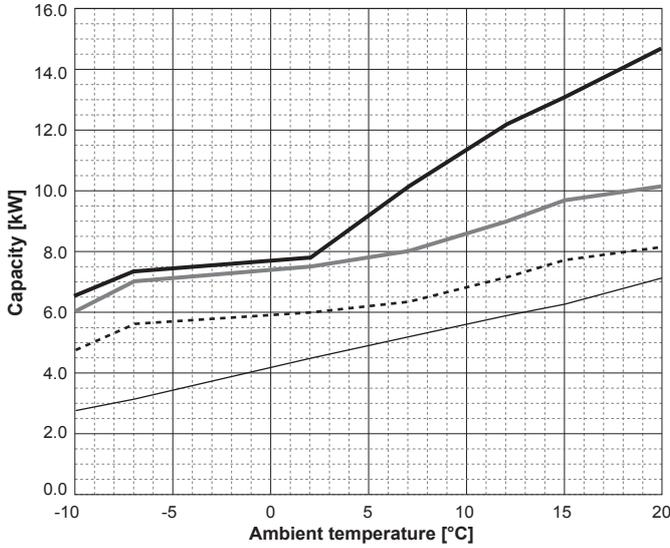

COP-Capacity

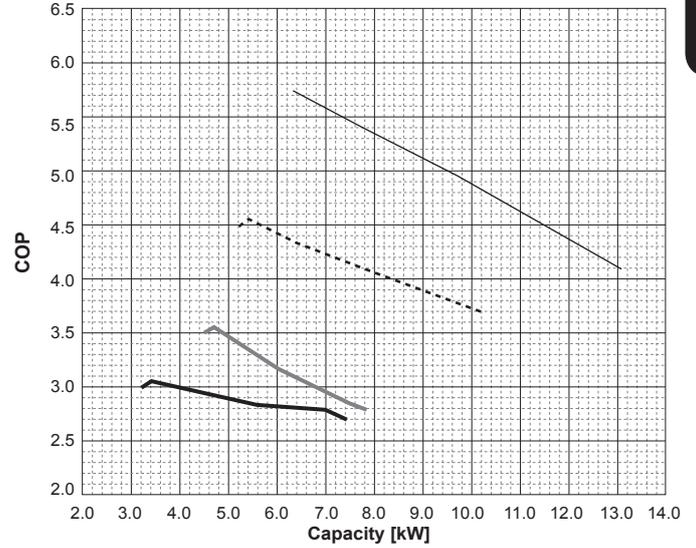

Water outlet temperature 45 [°C]

Capacity-Ambient temperature

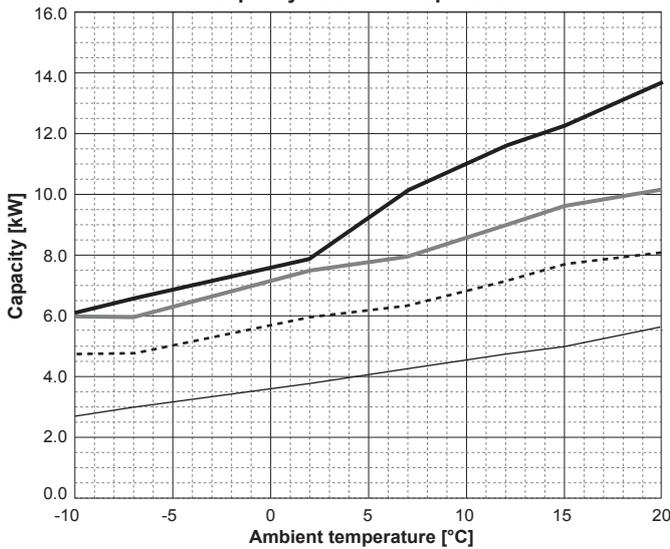

COP-Capacity

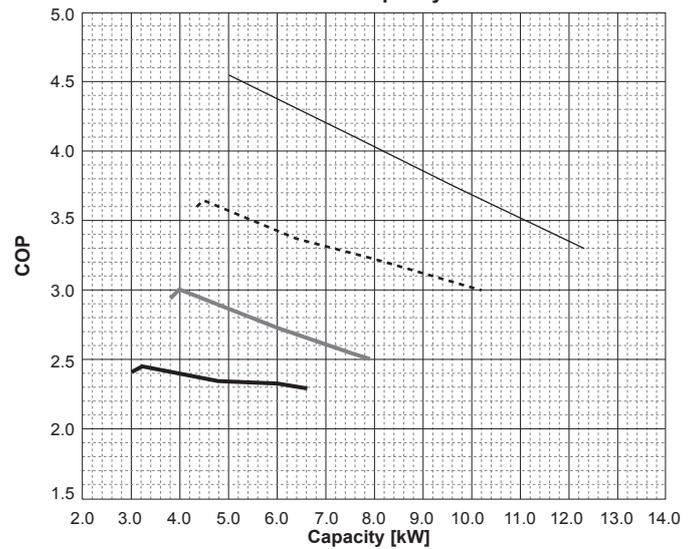

Water outlet temperature 55 [°C]

Capacity-Ambient temperature

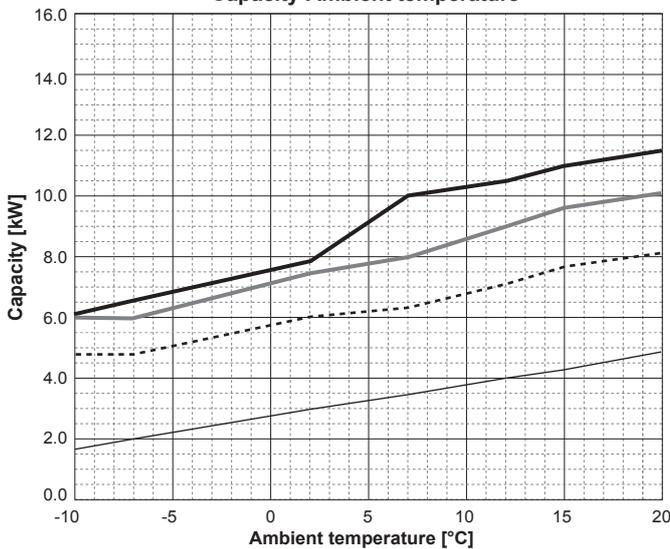

COP-Capacity

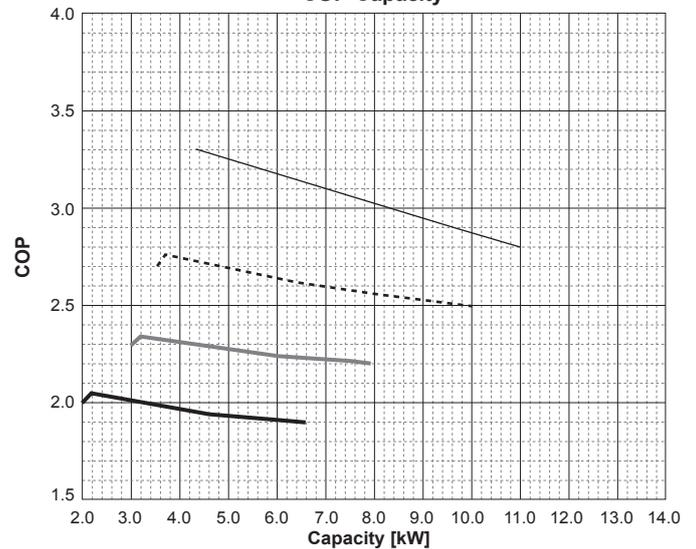

Outdoor unit

PUHZ-SHW80VHA(-BS)

■ Water outlet temperature 35 [°C]

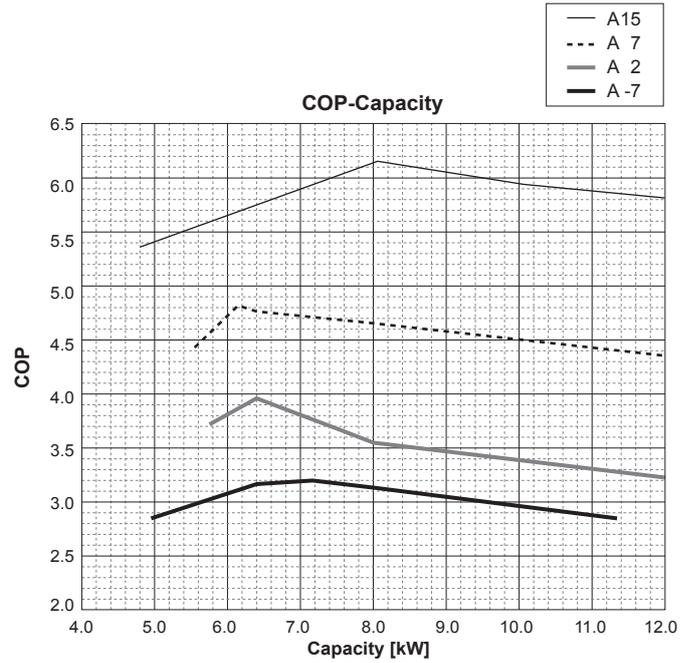
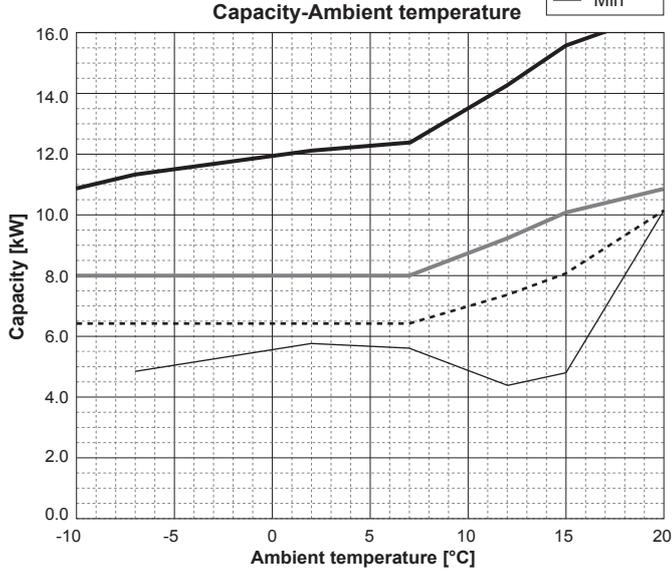

■ Water outlet temperature 45 [°C]

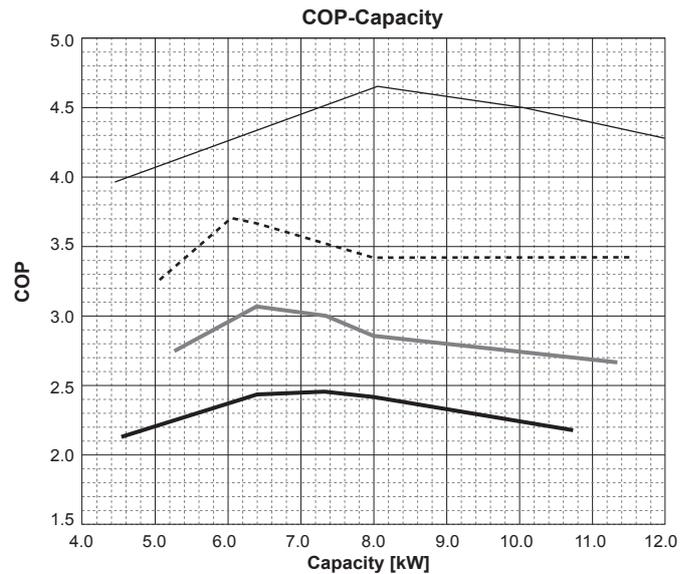
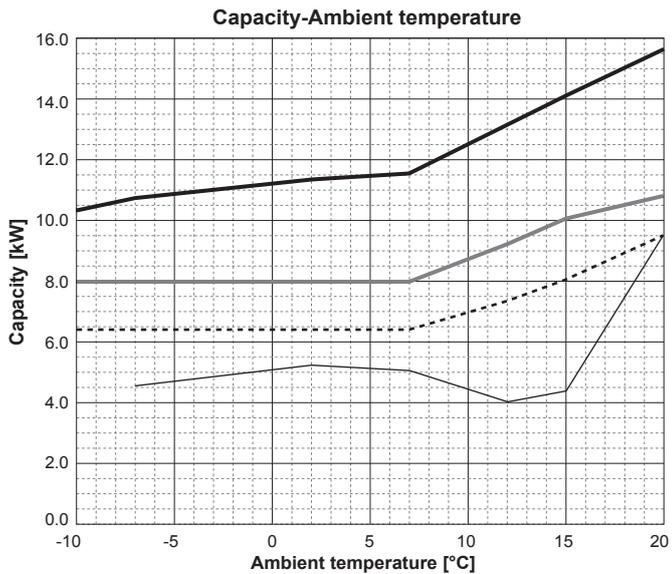

■ Water outlet temperature 55 [°C]

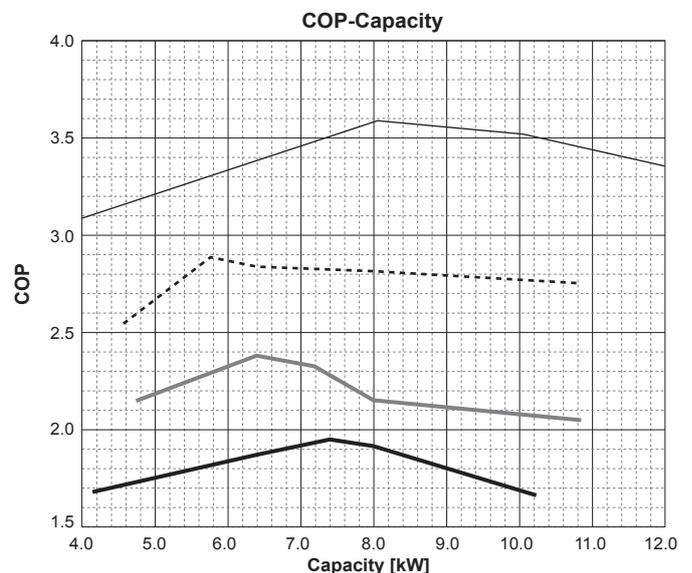
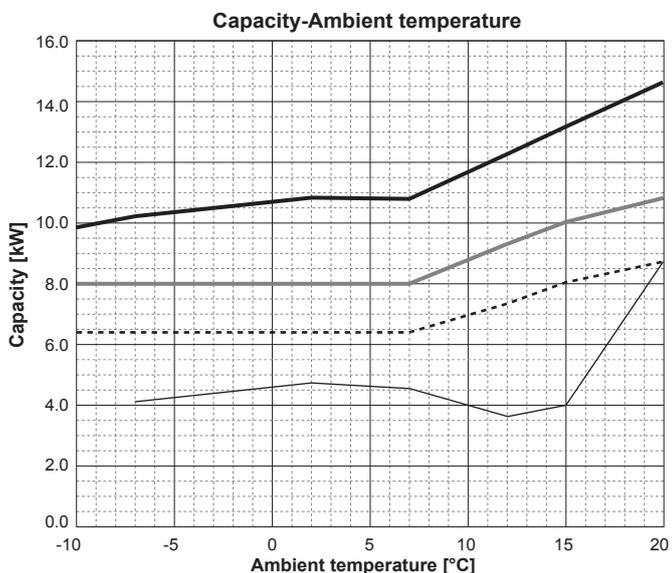

PUHZ-SHW112V/YHA(-BS)

Water outlet temperature 35 [°C]

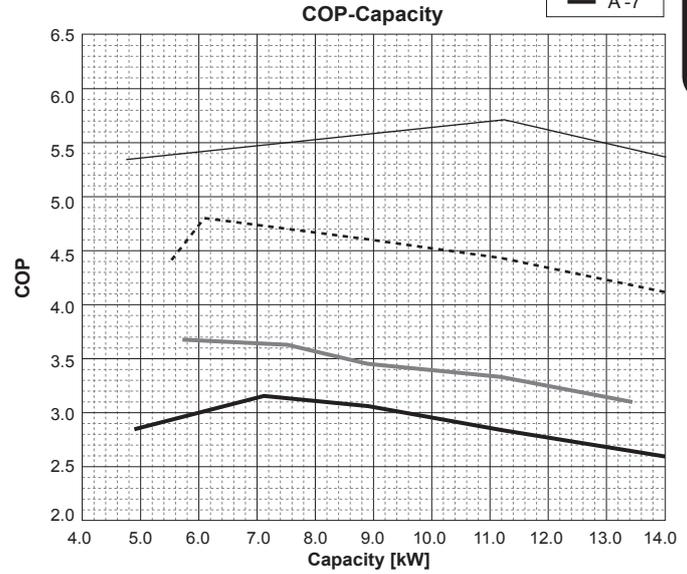
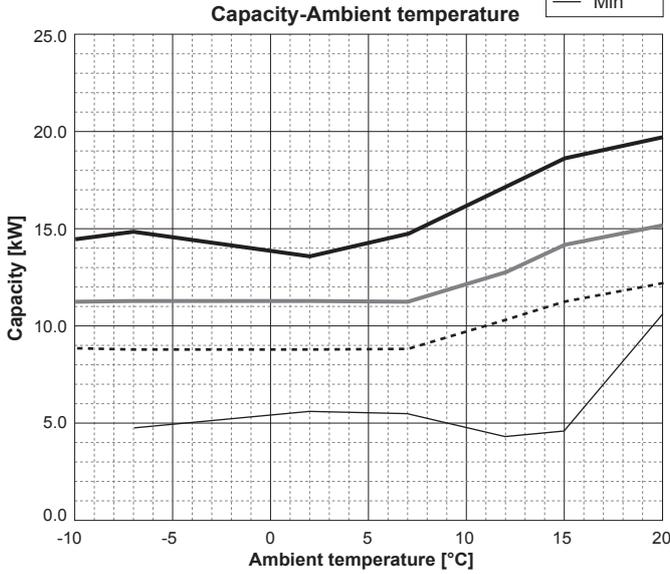

Water outlet temperature 45 [°C]

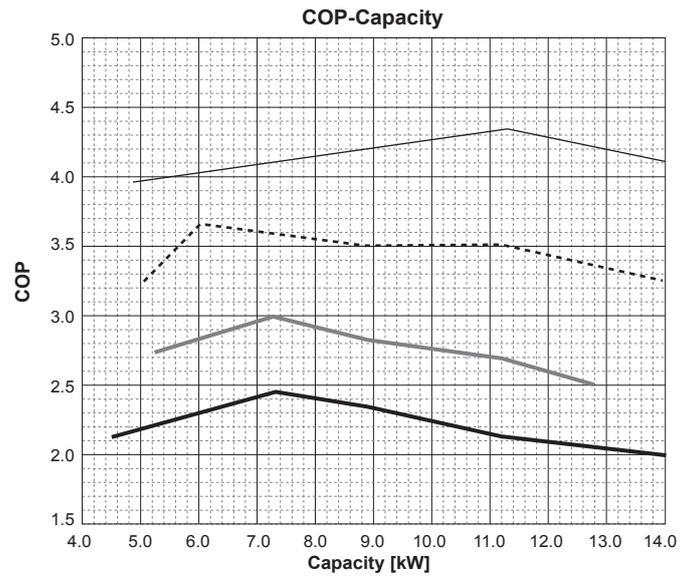
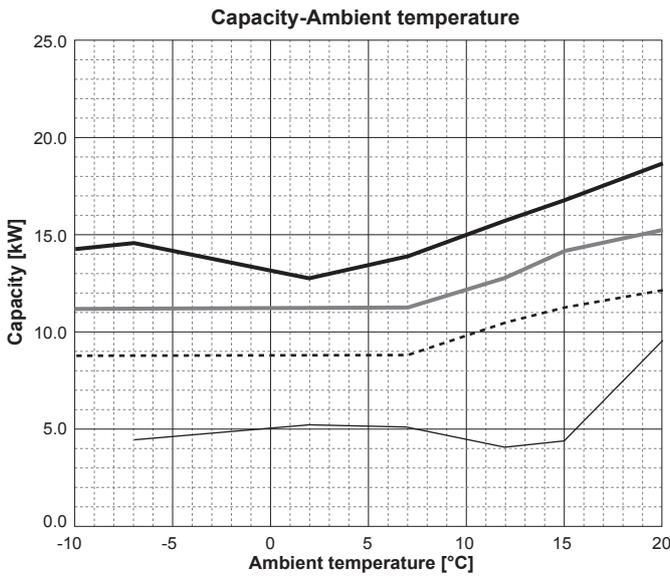

Water outlet temperature 55 [°C]

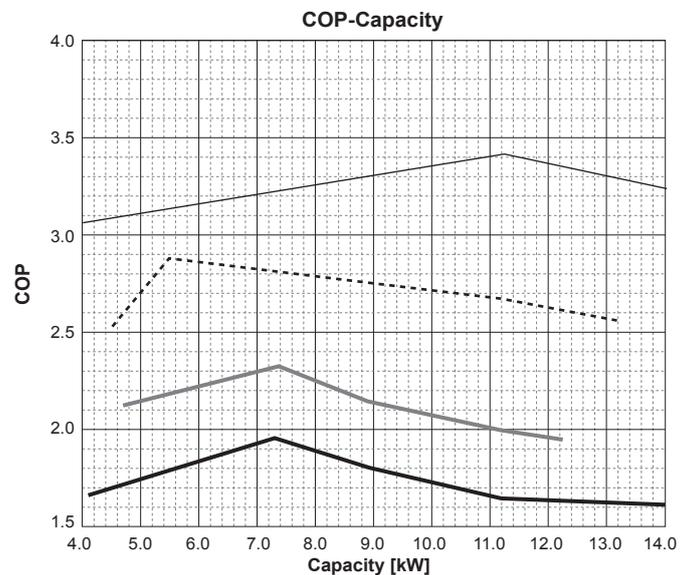
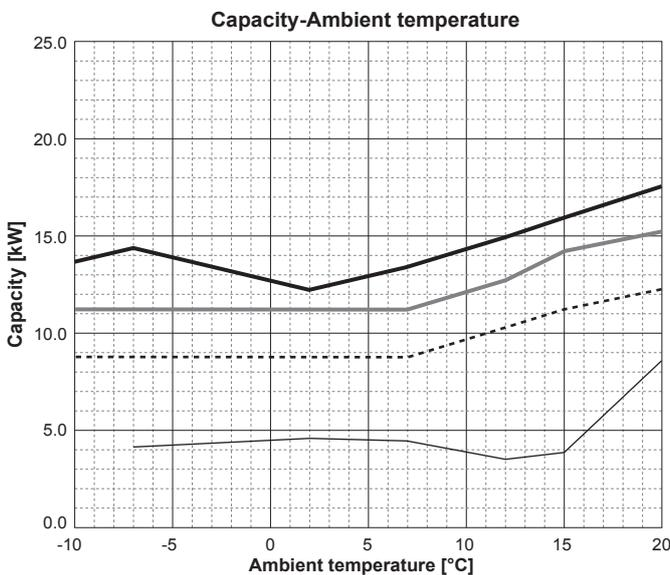

Outdoor unit

PUHZ-SHW140YHA(-BS)

■ Water outlet temperature 35 [°C]

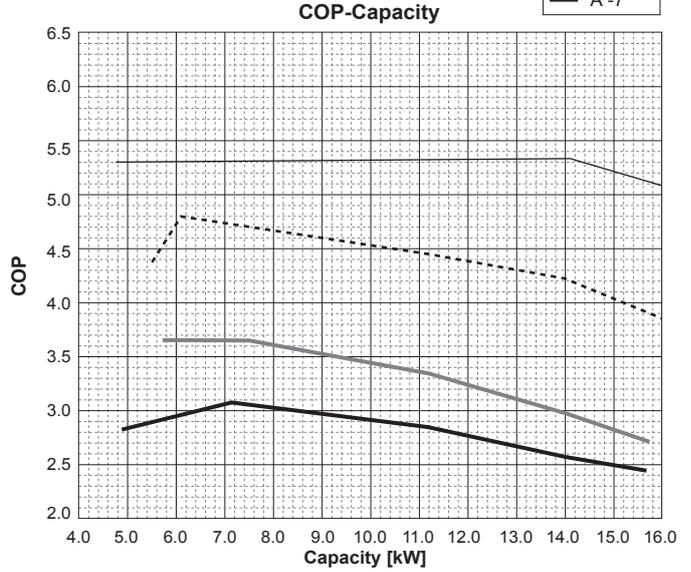
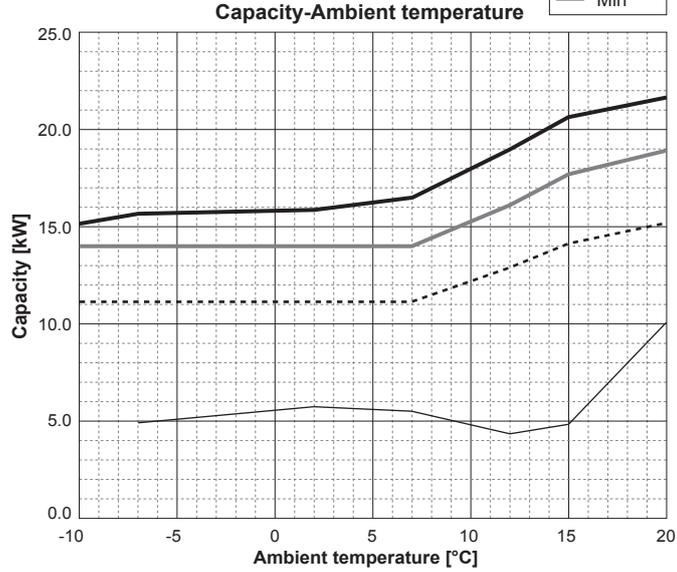

■ Water outlet temperature 45 [°C]

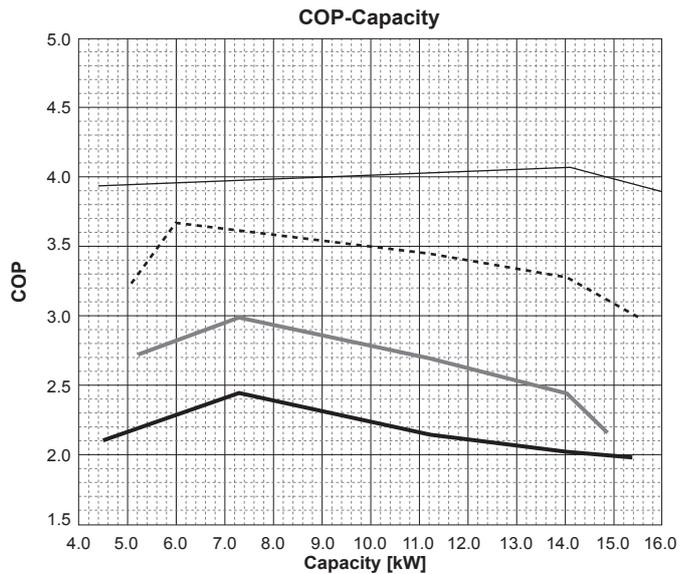
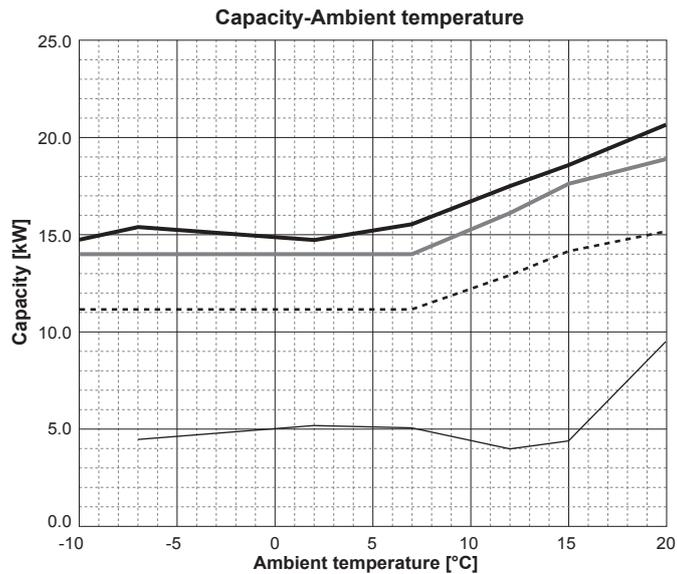

■ Water outlet temperature 55 [°C]

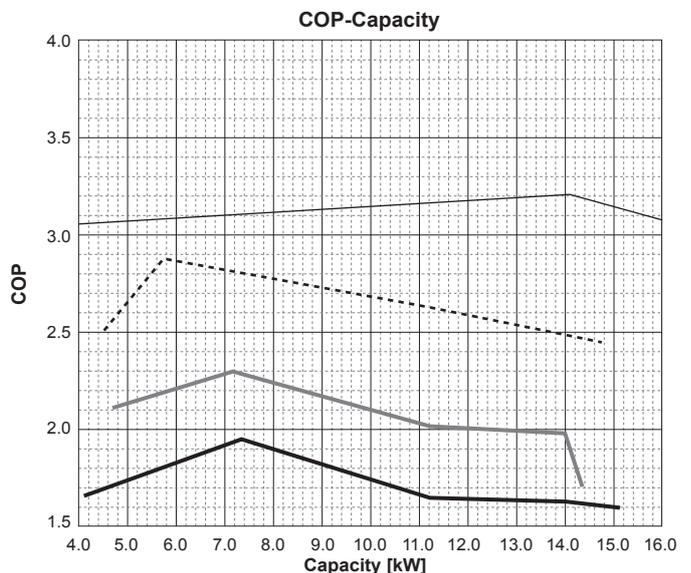
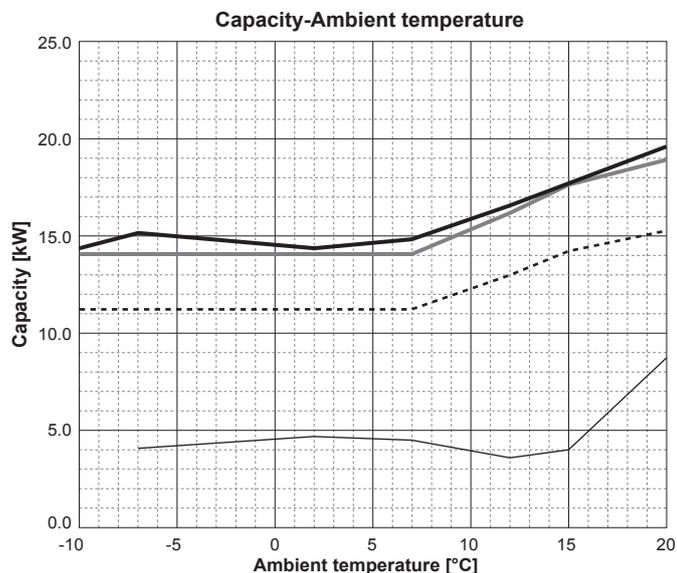

PUHZ-SHW230YKA2

Water outlet temperature 35 [°C]

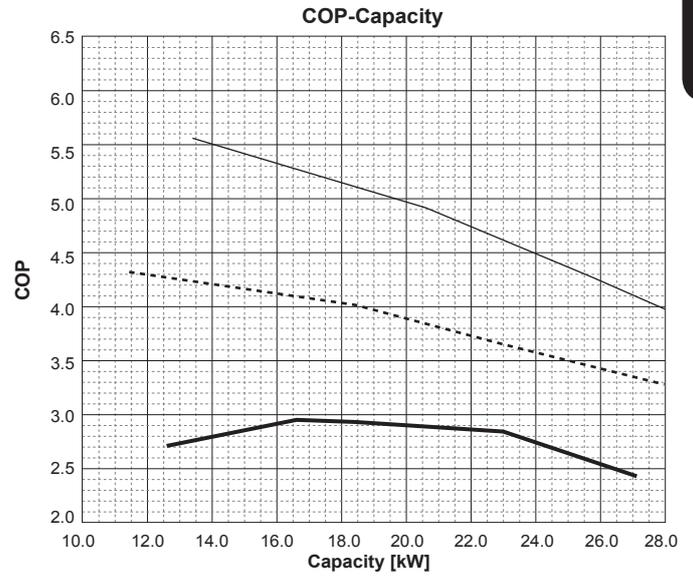
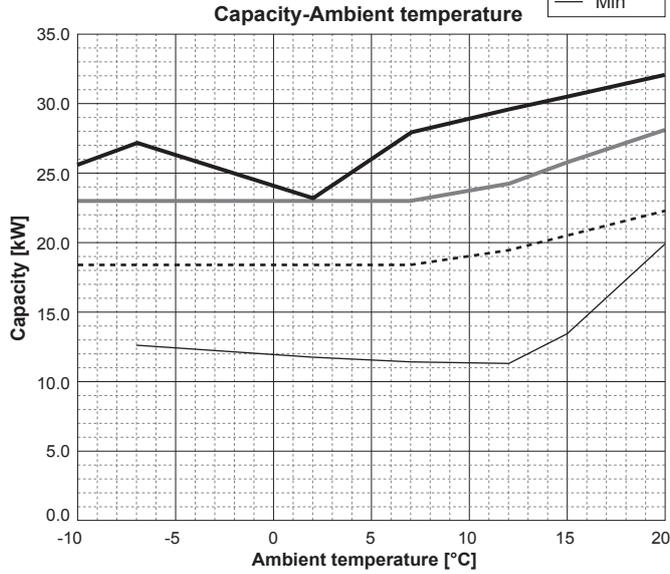

Water outlet temperature 45 [°C]

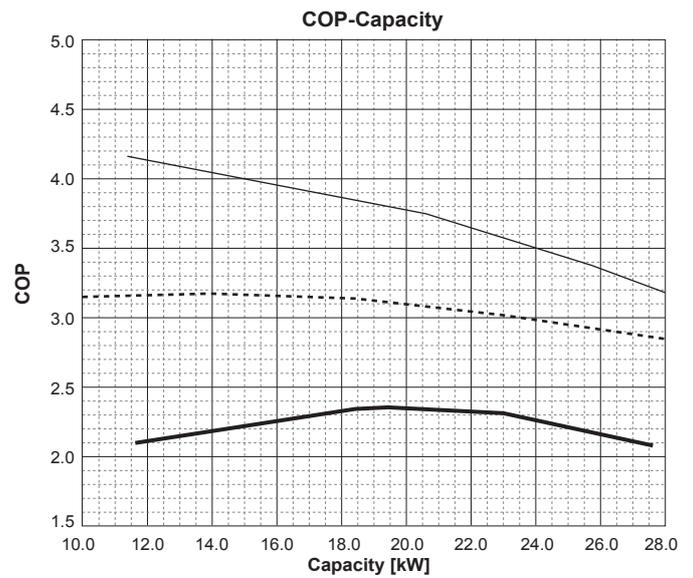
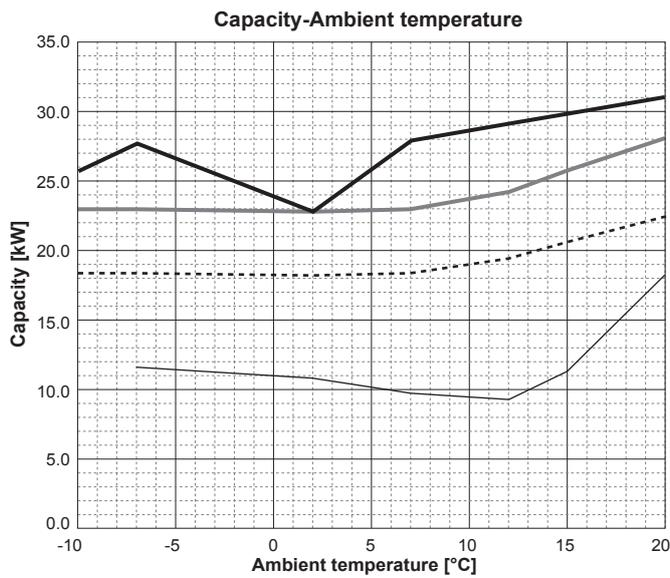

Water outlet temperature 55 [°C]

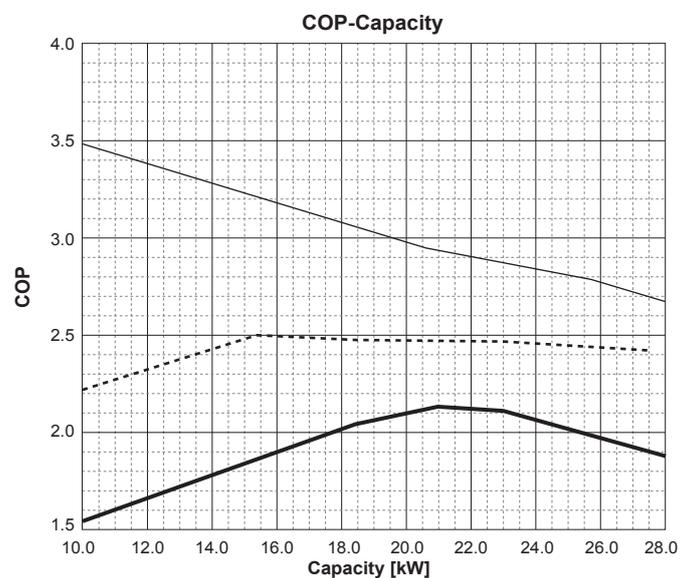
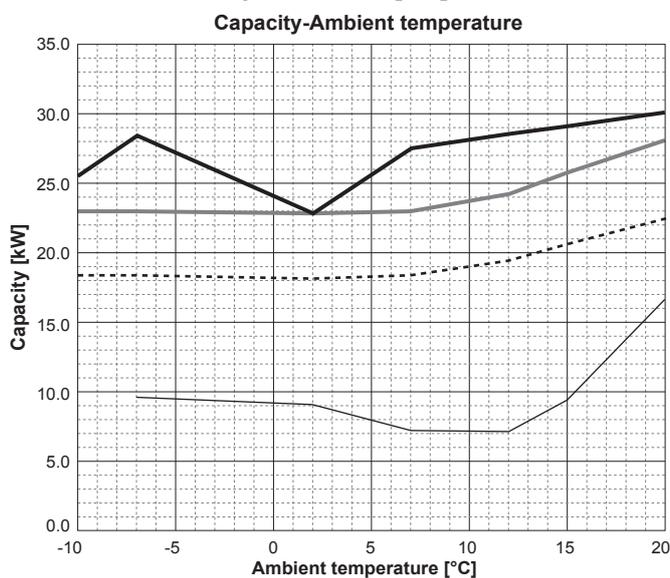

PUHZ-SHW80V/YAA(-BS)

■ Water outlet temperature 35 [°C]

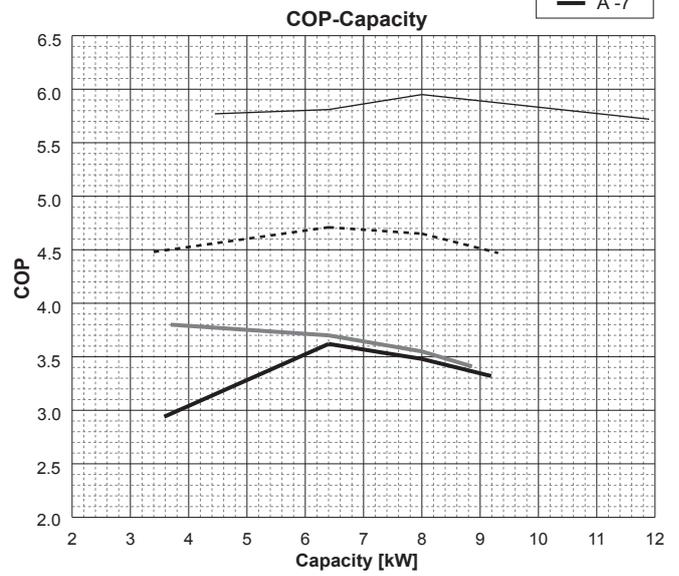
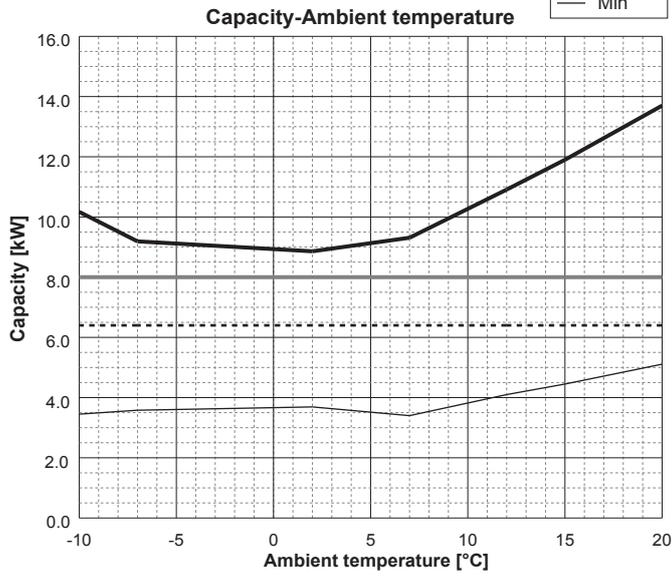

■ Water outlet temperature 45 [°C]

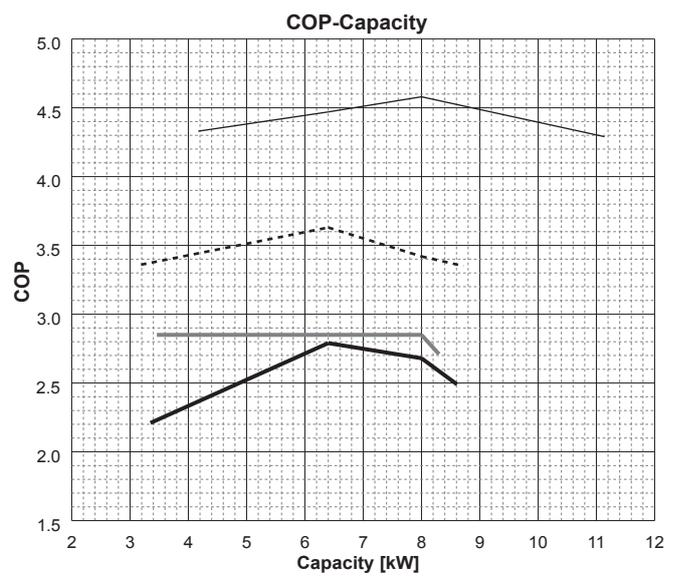
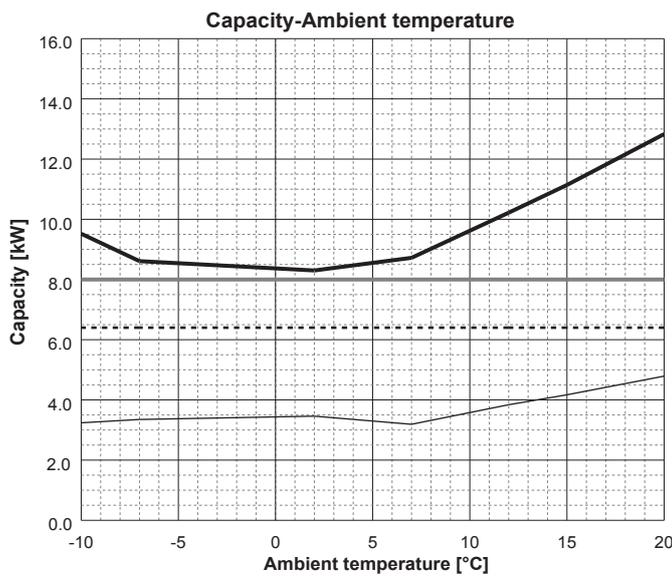

■ Water outlet temperature 55 [°C]

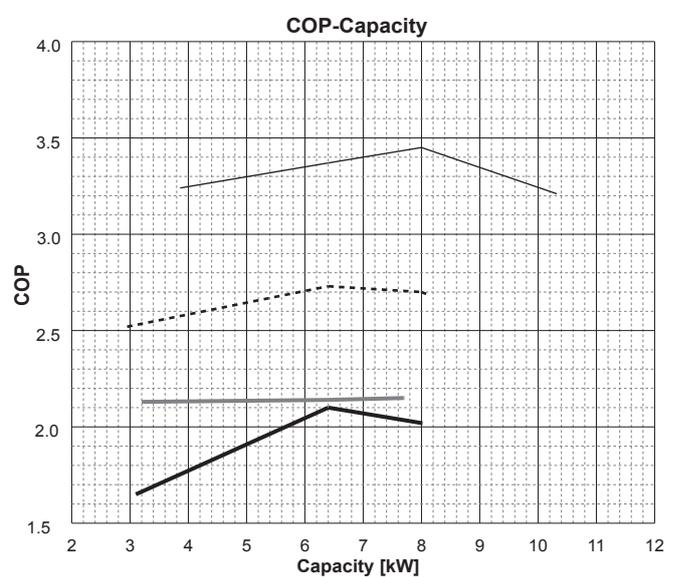
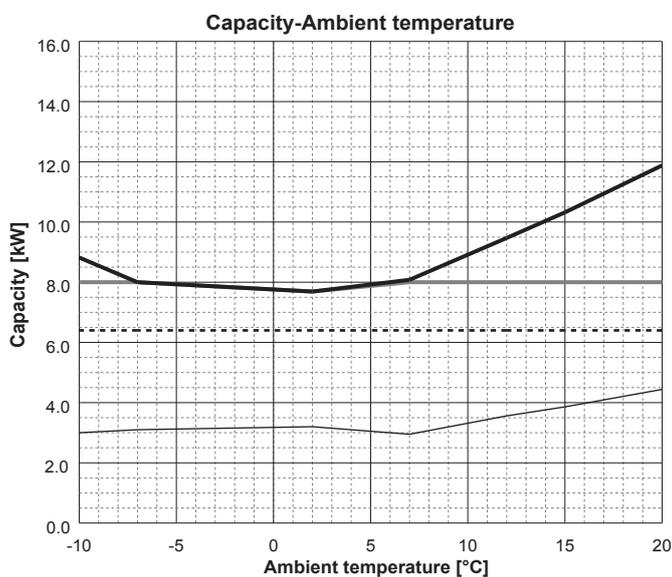

PUHZ-SHW112V/YAA(-BS)

■ **Water outlet temperature 35 [°C]**

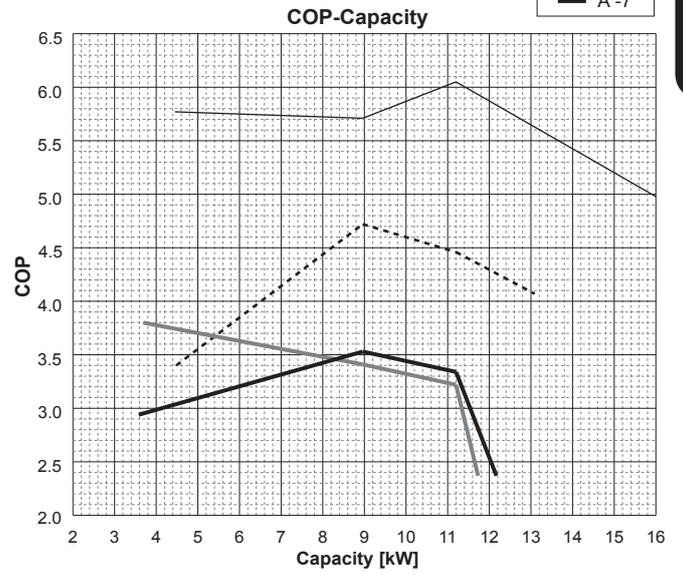
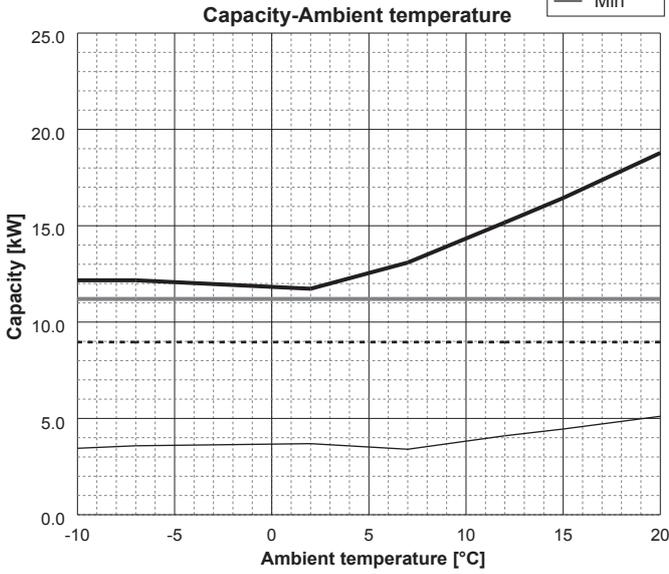

■ **Water outlet temperature 45 [°C]**

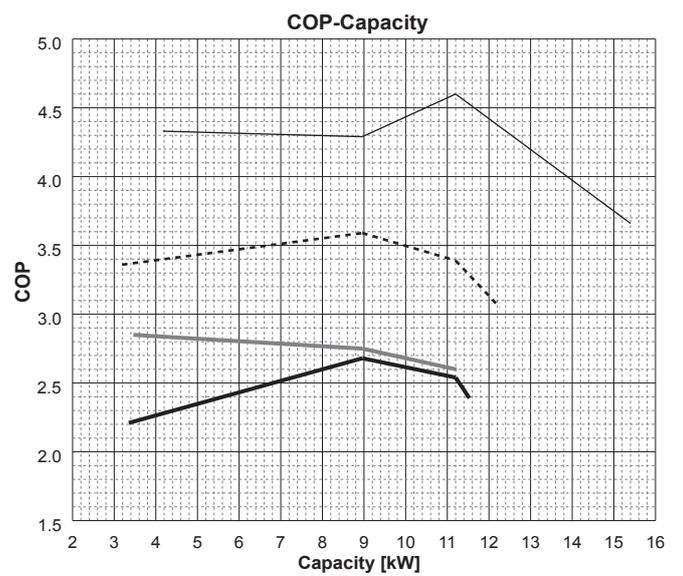
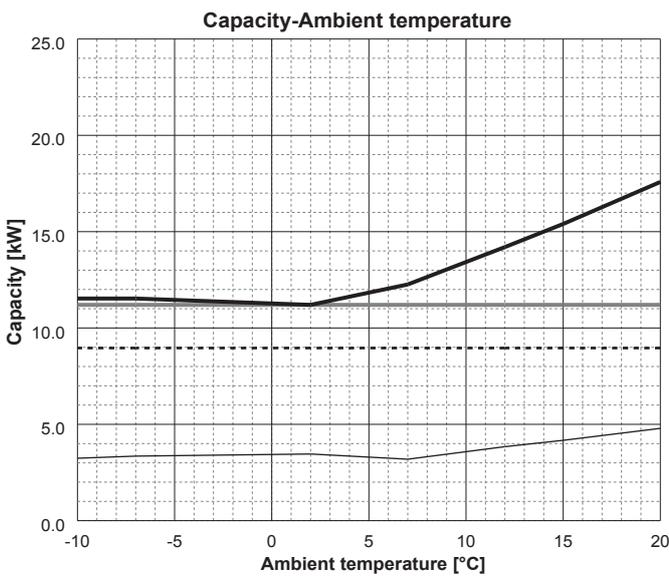

■ **Water outlet temperature 55 [°C]**

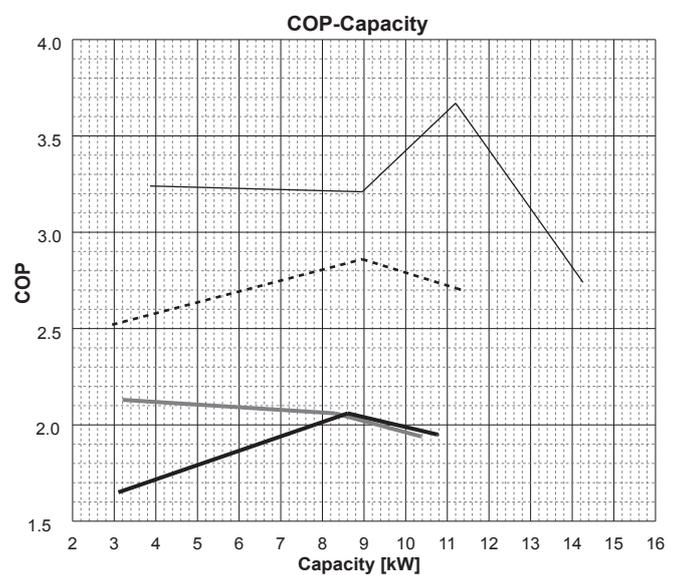
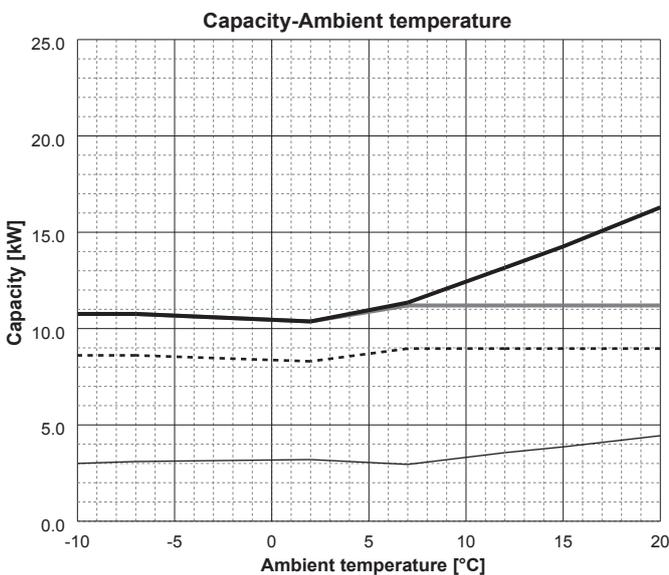

Outdoor unit

PUMY-P112/125/140V/YKM(E)4(-BS)

■ Water outlet temperature 35 [°C]

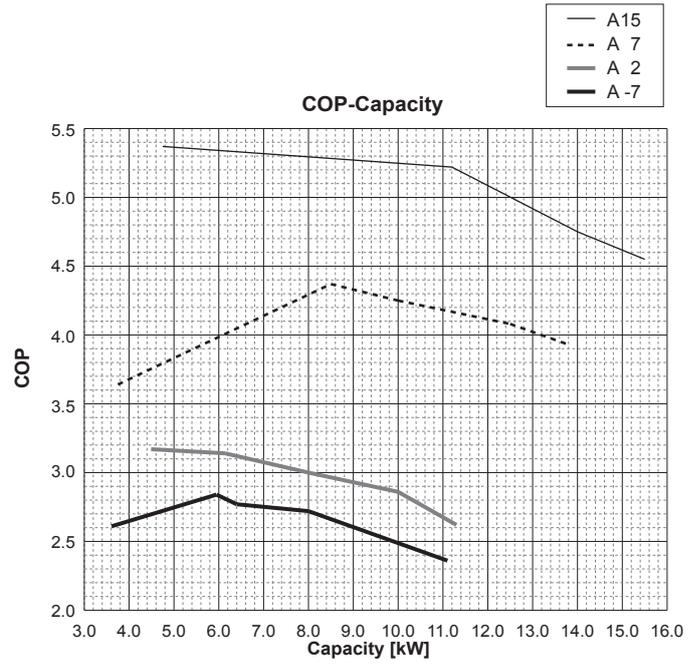
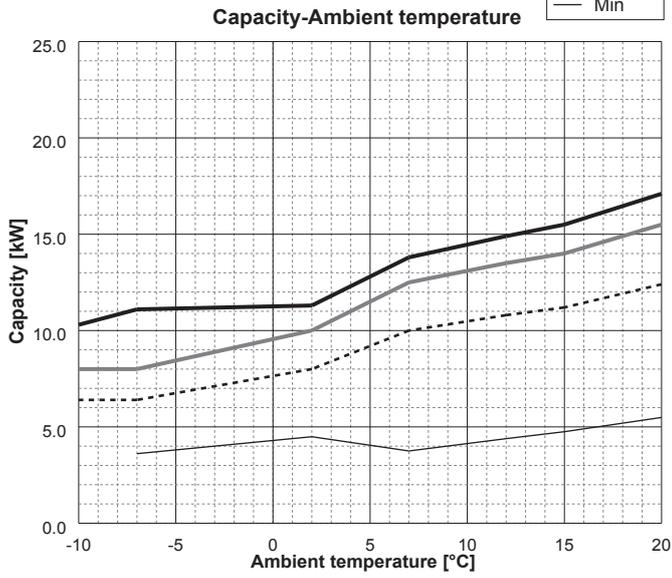

■ Water outlet temperature 45 [°C]

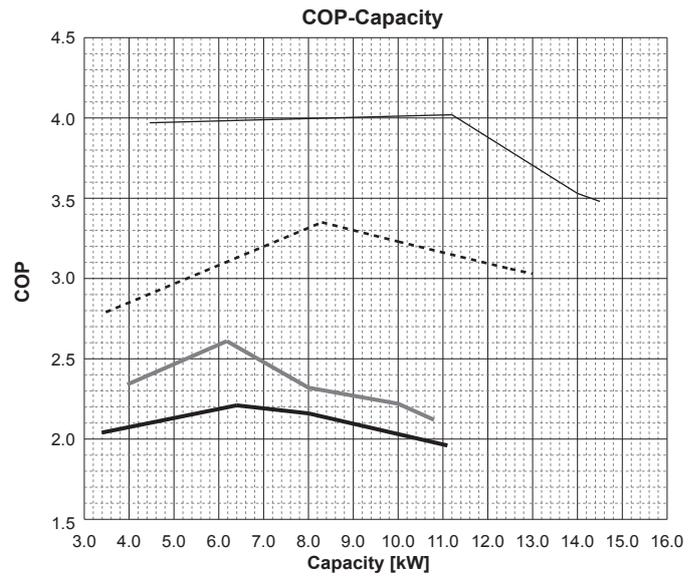
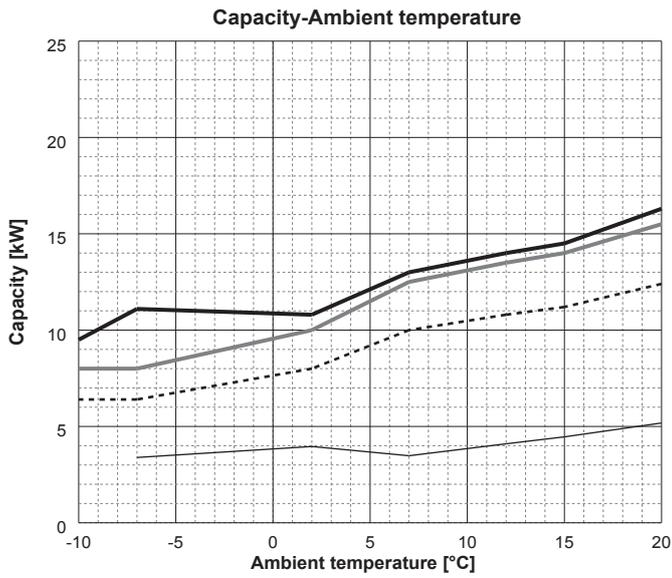

■ Water outlet temperature 55 [°C]

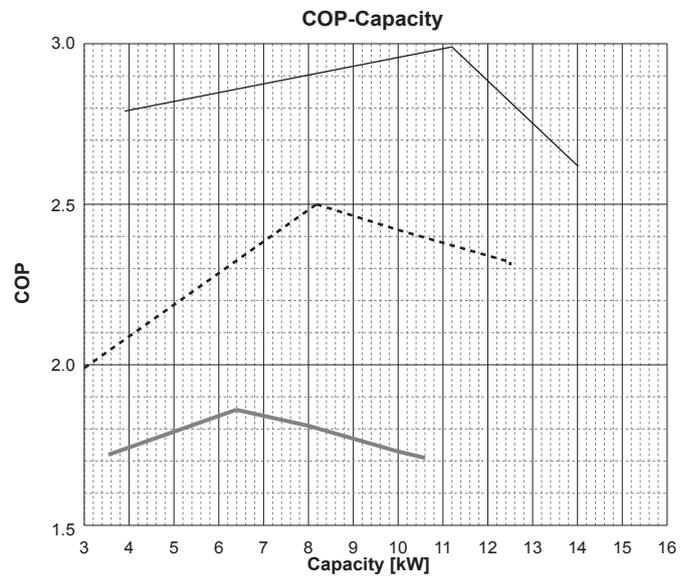
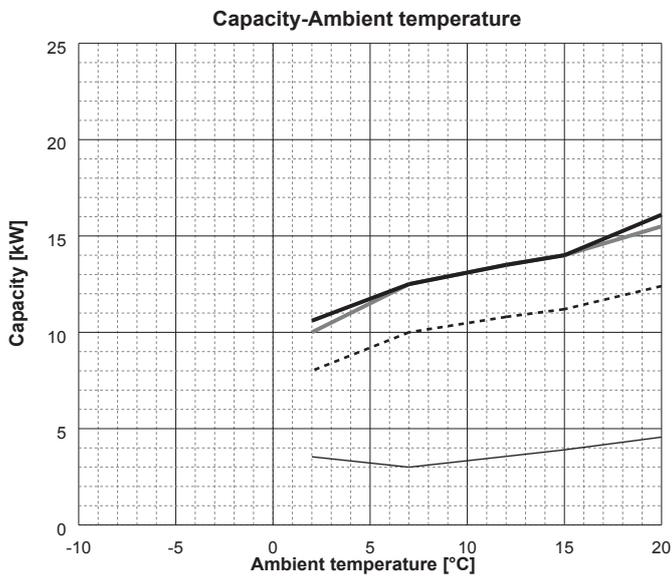

<Notes>

- 1) These data are measured based on EN14511-2013.
- 2) Max COP of each model at each condition are shown.
- 3) Gray highlighted data means integrated data including defrost operation.

5.4 Best COP

■ Power inverter

Water outlet temperature[°C]		35		45		55	
Ambient temperature[°C]		Capacity	COP	Capacity	COP	Capacity	COP
SUHZ-SW 45VA/VAH	-7	3.22	3.12 / 2.80	2.96	2.18 / 2.00	3.50	1.41 / 1.34
	2	3.32	3.42 / 3.07	3.50	2.80 / 2.55	3.50	2.04 / 1.91
		3.25	3.54 / 3.13	3.43	2.90 / 2.60	3.43	2.11 / 1.95
PUHZ-SW 50VKA(-BS)	7	4.10	5.10	4.50	3.70	4.50	2.70
	-7	2.56	3.02	2.45	2.44	2.34	1.86
		3.03	3.46	2.95	2.81	2.87	2.16
PUHZ-SW 75VHA(-BS)	2	3.81	3.84	3.56	3.09	3.31	2.34
	7	3.91	4.72	3.70	3.68	3.49	2.64
		6.16	2.95	5.92	2.26	5.33	1.80
PUHZ-SW 100V/YHA(-BS)	2	5.11	3.60	4.73	3.05	4.18	2.28
	-7	4.57	3.71	4.23	3.12	3.75	2.35
		5.64	4.72	5.94	3.65	6.14	2.87
PUHZ-SW 120V/YHA(-BS)	7	7.15	2.95	7.35	2.27	7.48	1.68
	2	7.32	3.69	7.17	2.86	6.89	2.15
		6.74	3.88	6.63	2.97	6.42	2.29
PUHZ-SW 160YKA(-BS)	7	6.21	4.71	6.35	3.62	6.58	2.80
	-7	8.11	2.92	8.34	2.26	8.56	1.76
		7.81	3.67	7.54	2.88	7.32	2.12
PUHZ-SW 200YKA(-BS)	2	6.82	3.84	6.78	2.97	6.72	2.21
	7	9.24	4.65	9.55	3.54	9.89	2.71
		11.61	2.88	10.82	2.32	10.10	1.80
PUHZ-SW 75V/YAA(-BS)	2	12.78	3.42	12.78	2.65	12.77	1.98
	-7	10.58	3.46	9.87	2.70	9.04	2.07
		17.61	4.57	17.61	3.50	17.61	2.63
PUHZ-SW 100V/YAA(-BS)	7	11.57	2.86	10.78	2.30	10.07	1.77
	2	12.78	3.37	12.78	2.61	12.77	1.94
		10.53	3.41	9.82	2.66	8.98	2.03
PUHZ-SW W112VHA(-BS)	7	17.61	4.44	17.61	3.47	17.61	2.55
	-7	3.63	3.23	3.51	2.55	3.37	2.01
		6.00	3.53	5.79	2.79	5.57	2.20
PUHZ-SW 85V/YAA	2	4.20	3.85	4.06	3.04	3.90	2.40
	7	4.20	4.77	4.06	3.77	3.90	2.97
		4.94	3.31	4.77	2.61	4.59	2.06
PUHZ-SW 112V/YAA	2	8.96	3.41	8.65	2.69	8.32	2.12
	-7	6.80	3.98	6.57	3.14	6.31	2.48
		6.80	4.63	6.57	3.66	6.31	2.88
PUHZ-W 71VHA2	7	7.15	3.01	7.35	2.33	7.48	1.68
	2	7.32	3.75	7.32	2.93	6.89	2.17
		6.75	3.95	6.70	3.09	6.40	2.31
PUHZ-W 112V/YAA	7	6.30	4.77	6.30	3.66	6.60	2.83
	-7	6.0	2.74	6.0	2.27	6.0	1.89
		4.8	3.74	4.5	2.9	4.1	2.25
PUHZ-W 85V/YAA	2	5.0	4.03	4.6	3.17	4.3	2.45
	7	6.0	4.92	5.5	3.55	5.1	2.82
		7.2	3.33	7.2	2.51	7.2	1.88
PUHZ-W 112V/YAA	2	7.3	3.70	6.7	2.79	6.0	2.07
	-7	7.2	4.12	6.5	3.02	5.8	2.21
		8.5	4.90	7.9	3.88	7.2	2.89

■ Mr.SLIM+

Water outlet temperature[°C]		35		45		55	
Ambient temperature[°C]		Capacity	COP	Capacity	COP	Capacity	COP
PUHZ-FRP 71VHA2	-7	3.40	3.05	3.20	2.45	2.20	2.05
	2	4.70	3.55	4.00	3.00	3.20	2.35
		4.40	3.65	3.90	3.10	2.90	2.45
7	5.40	4.55	4.50	3.65	3.70	2.75	

Outdoor unit

Zubadan

Water outlet temperature[°C]		35		45		55	
Ambient temperature[°C]		Capacity	COP	Capacity	COP	Capacity	COP
PUHZ-SHW 80VHA(-BS)	-7	7.18	3.20	7.33	2.46	7.40	1.97
	2	7.54	3.68	7.35	3.00	7.21	2.33
		6.82	4.06	6.72	3.15	6.66	2.46
7	6.15	4.82	6.03	3.70	5.79	2.90	
PUHZ-SHW 112V/YHA(-BS)	-7	7.16	3.18	7.31	2.45	7.38	1.96
	2	7.52	3.66	7.33	2.99	7.19	2.32
		6.80	4.04	6.70	3.13	6.64	2.45
7	6.13	4.80	6.01	3.68	5.77	2.89	
PUHZ-SHW 140YHA(-BS)	-7	7.14	3.18	7.29	2.44	7.36	1.96
	2	7.50	3.65	7.31	2.98	7.17	2.31
		6.79	4.03	6.69	3.13	6.63	2.44
7	6.12	4.79	6.00	3.67	5.76	2.88	
PUHZ-SHW 230YKA2	-7	16.68	2.95	19.41	2.37	20.98	2.13
	2	13.20	3.45	13.04	2.59	12.91	2.27
		12.49	3.55	12.22	2.73	12.00	2.33
7	11.43	4.31	13.94	3.17	15.42	2.50	
PUHZ-SHW 80V/YAA(-BS)	 -7	8.00	3.48	8.00	2.68	8.00	2.02
	-7	4.95	3.32	4.78	2.62	4.59	2.07
	2	8.00	3.55	7.73	2.80	7.42	2.21
		6.81	3.99	6.58	3.15	6.32	2.48
	7	6.81	4.64	6.58	3.67	6.32	2.89
PUHZ-SHW 112V/YAA(-BS)	 -7	11.20	3.34	11.2	2.54	10.76	1.95
	-7	4.94	3.31	4.77	2.61	4.59	2.06
	2	8.96	3.41	8.65	2.69	8.32	2.12
		6.80	3.98	6.57	3.14	6.31	2.48
	7	6.80	4.63	6.57	3.66	6.31	2.88

 : This icon means injection circuit is active.

Inverter multi In case of ATW unit single connection

Water outlet temperature[°C]		35		45		55	
Ambient temperature[°C]		Capacity	COP	Capacity	COP	Capacity	COP
PUMY-P 112/125/140 V/YKM(E)4(-BS)	-7	5.95	2.84	6.40	2.21	—	—
	2	6.14	3.14	6.18	2.61	6.39	1.86
		5.17	3.33	5.15	2.87	5.39	1.95
7	8.50	4.37	8.30	3.35	8.18	2.50	

5.5 Correcting capacity for changes in the length of refrigerant piping

■ SUHZ-SW45VA(H)

PUHZ-SW50VKA(-BS)
PUHZ-SW75VHA(-BS)

PUHZ-SW75VAA(-BS)
PUHZ-SW75YAA(-BS)

<Method for obtaining the equivalent piping length>

$$\text{Equivalent length} = (\text{piping length}) + 0.3 \times (\text{number of bends in the piping})$$

<Cooling>

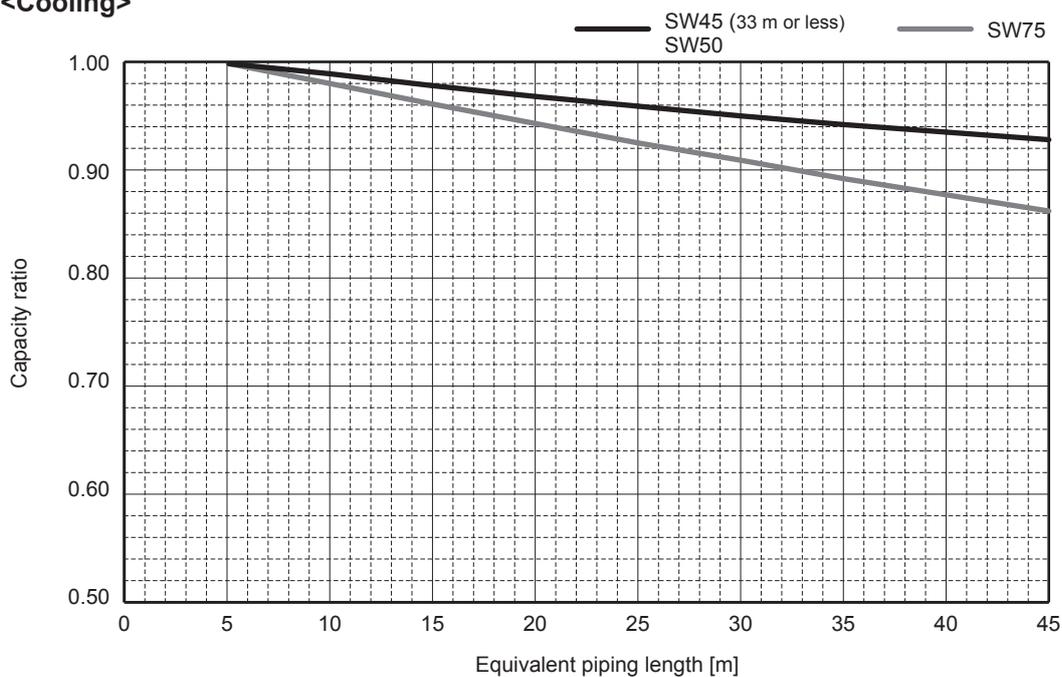

<Heating>

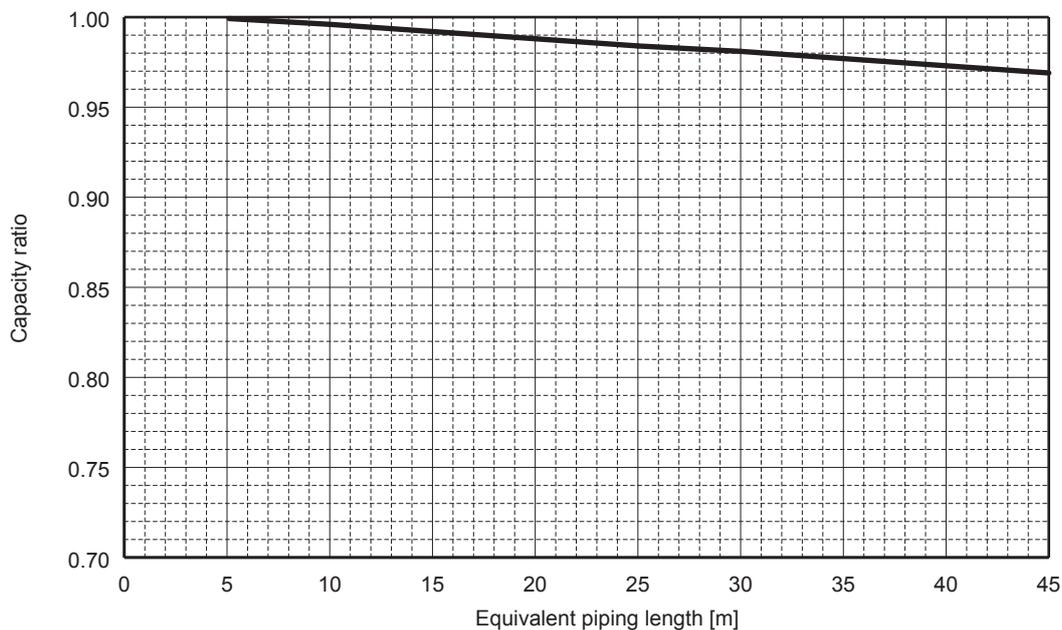

- PUAZ-SW100/120VHA(-BS) PUAZ-SHW80/112VHA(-BS)
- PUAZ-SW100/120YHA(-BS) PUAZ-SHW112/140YHA(-BS)
- PUAZ-SW100VAA(-BS) PUAZ-SHW80/112VAA(-BS)
- PUAZ-SW100YAA(-BS) PUAZ-SHW80/112YAA(-BS)

<Cooling>

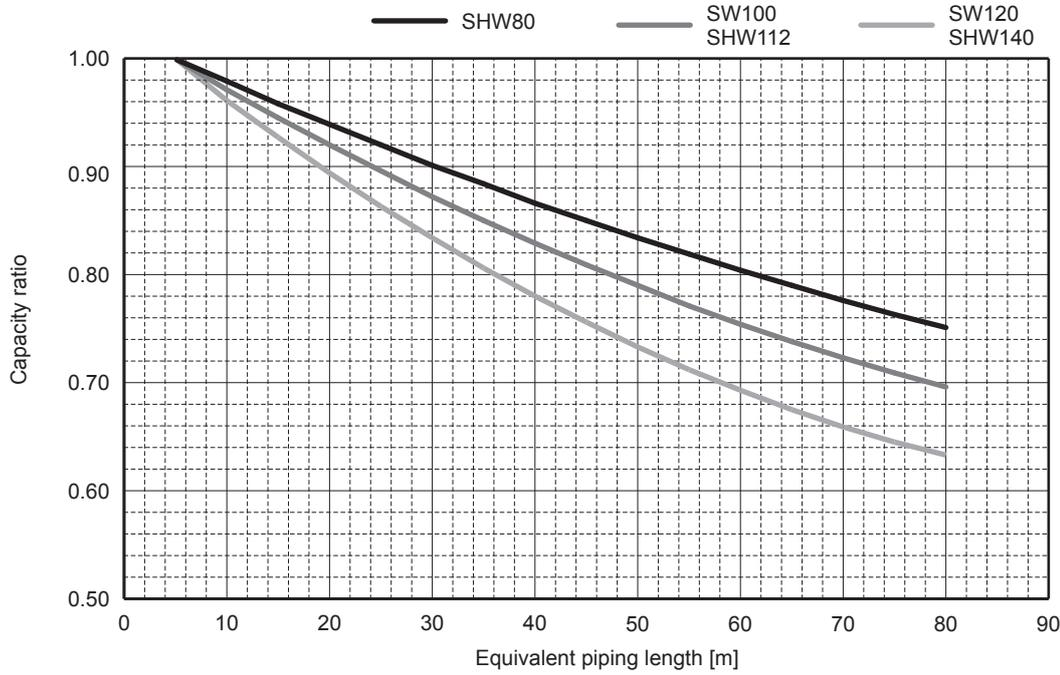

<Heating>

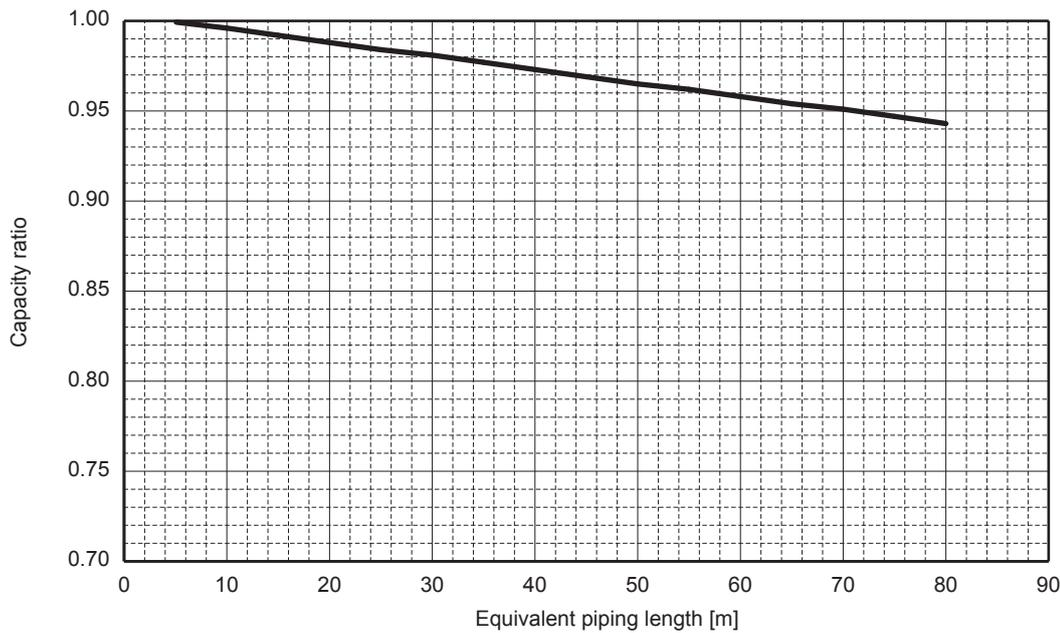

PUAZ-SW160YKA(-BS) PUAZ-SHW230YKA2
 PUAZ-SW200YKA(-BS)

<Cooling>

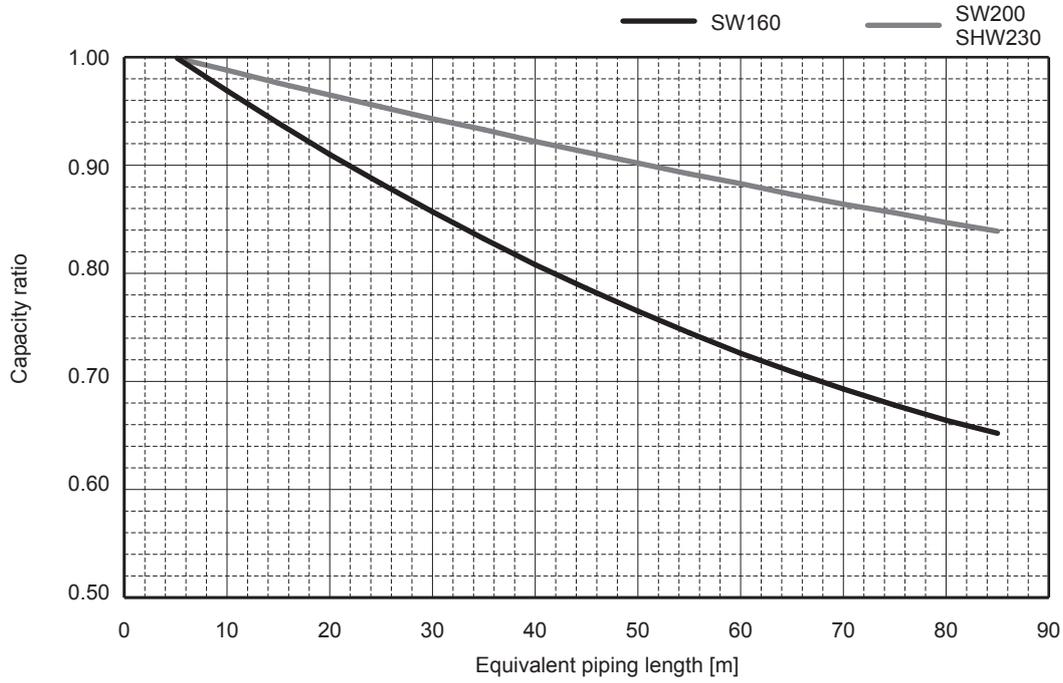

<Heating>

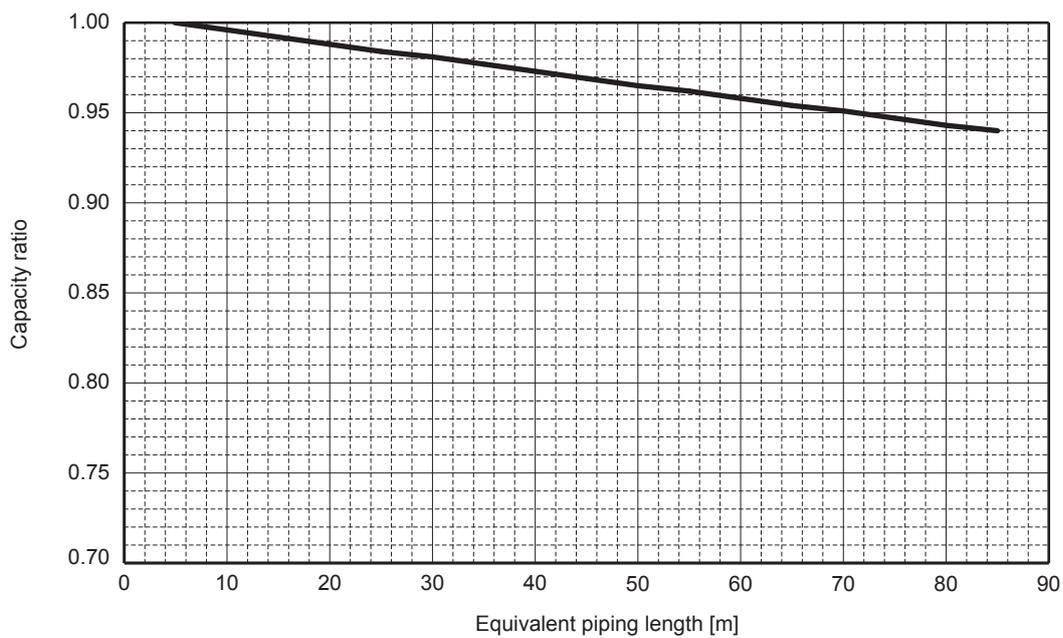

■ PUAZ-FRP71VHA2

<Heating>

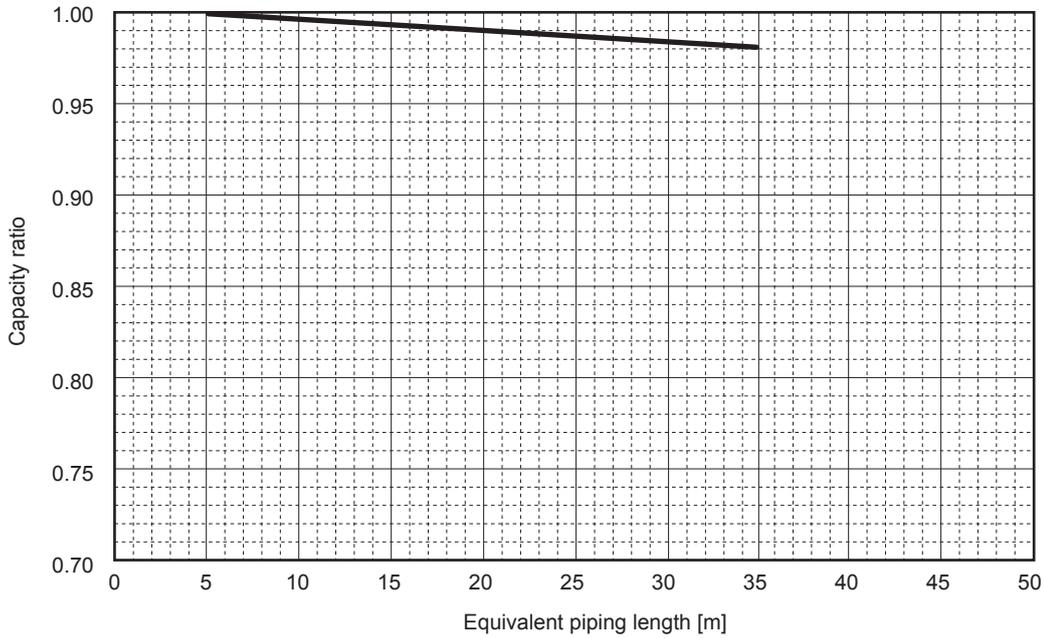

■ PUMY-P112/125/140VKM4(-BS)
 PUMY-P112/125/140YKM4(-BS)
 PUMY-P112/125/140YKME4(-BS)

<Heating>

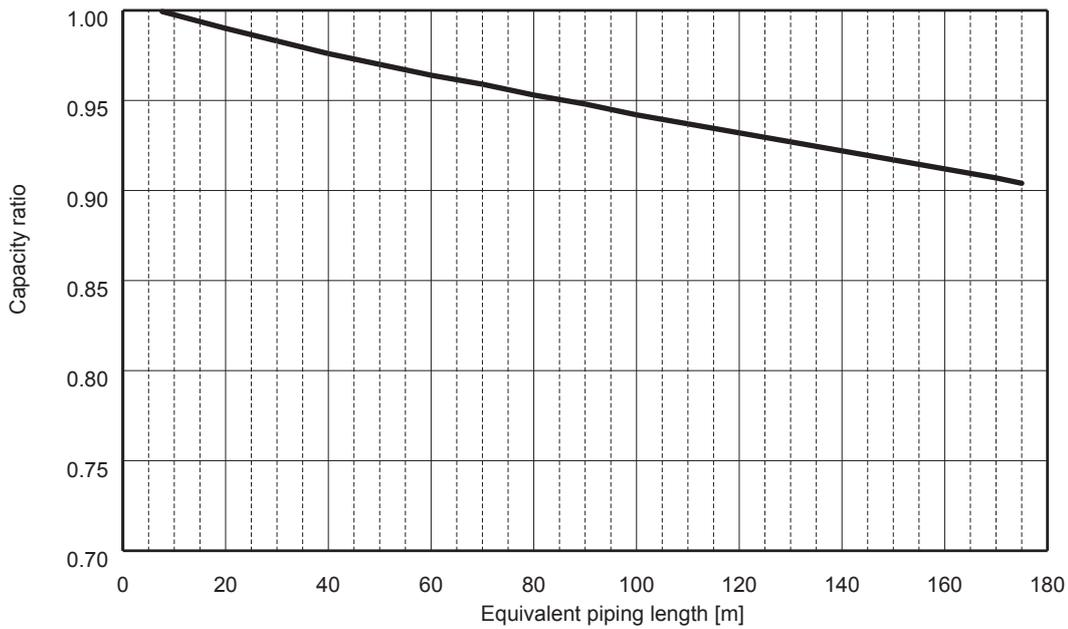

6.1 Packaged-type units

PUHZ-W50VHA2(-BS)

MODE	SPL(dB)	LINE
COOLING	45	○—○
HEATING	46	●—●

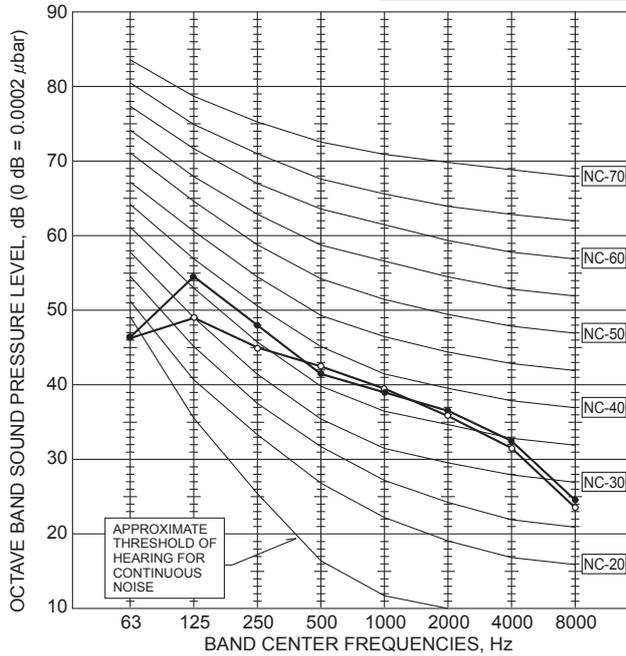

PUHZ-W85VHA2(-BS)

MODE	SPL(dB)	LINE
COOLING	48	○—○
HEATING	48	●—●

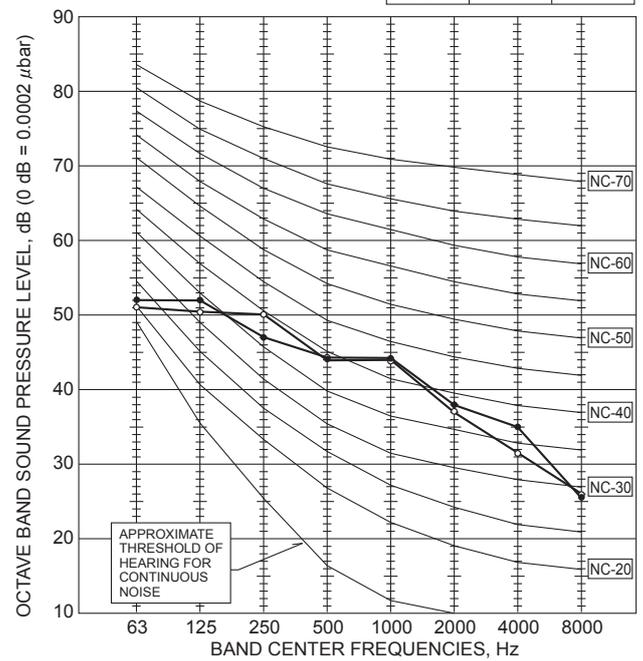

PUHZ-W85VAA PUHZ-W85YAA

MODE	SPL(dB)	LINE
COOLING	45	○—○
HEATING	45	●—●

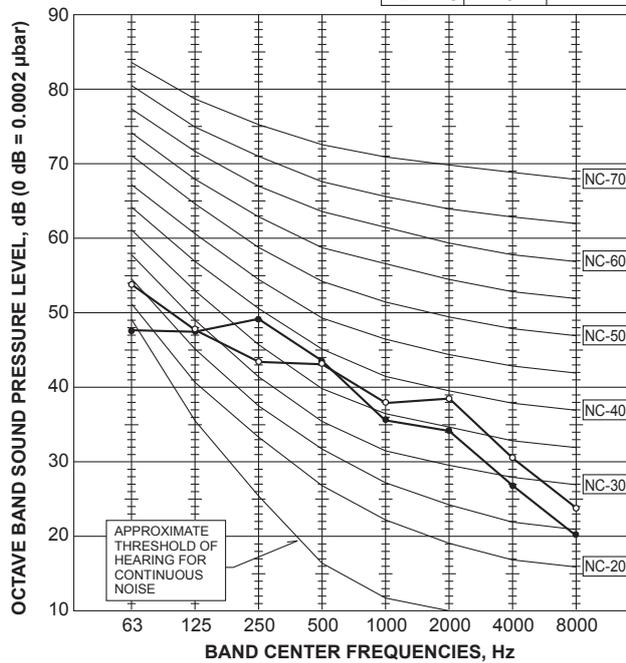

PUHZ-W112VAA PUHZ-W112YAA

MODE	SPL(dB)	LINE
COOLING	49	○—○
HEATING	47	●—●

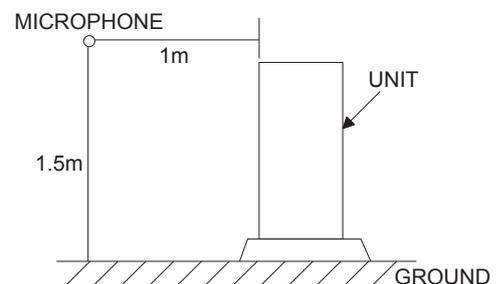
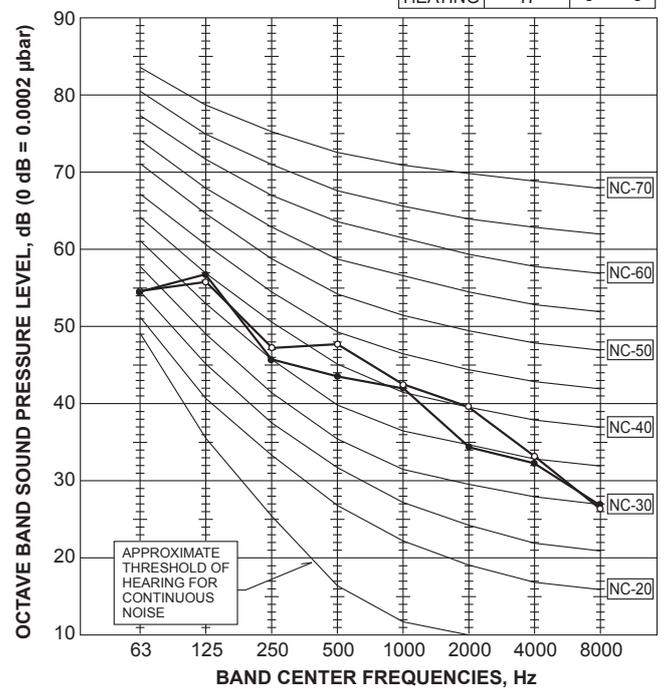

<Notes>

- 1) Sound data is taken when the system is running stably.
- 2) Relatively large noise could be heard transiently in the case 4-way valve, or LEV operates.

Outdoor unit

PUHZ-W112VHA(-BS)

MODE	SPL(dB)	LINE
COOLING	53	○—○
HEATING	53	●—●

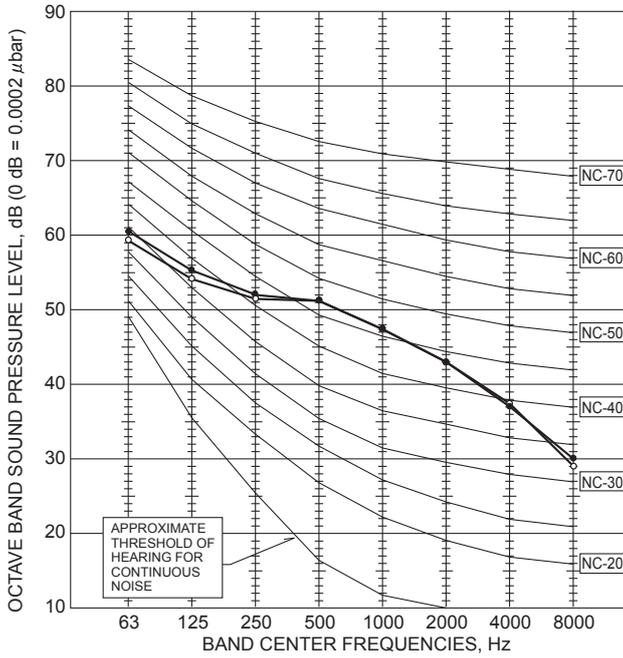

PUHZ-HW112YHA2(-BS)

PUHZ-HW140VHA2(-BS)

PUHZ-HW140YHA2(-BS)

MODE	SPL(dB)	LINE
COOLING	53	○—○
HEATING	53	●—●

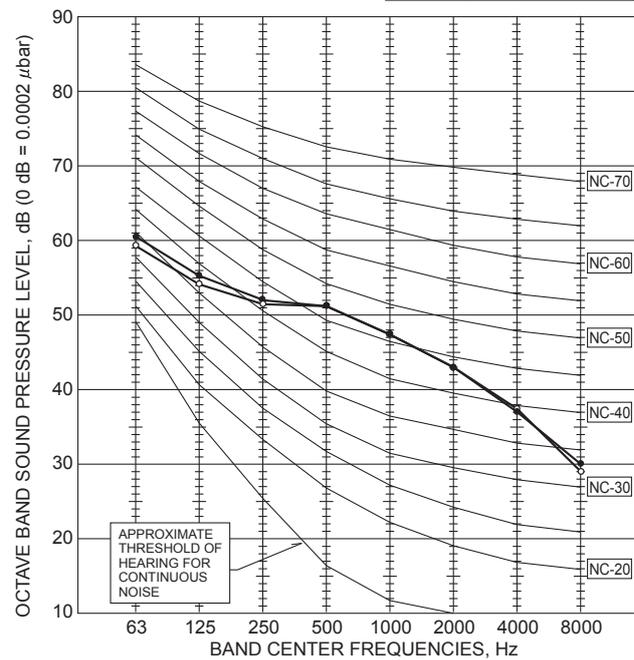

<Notes>

- 1) Sound data is taken when the system is running stably.
- 2) Relatively large noise could be heard transiently in the case 4-way valve, or LEV operates.

6.2 Split-type units

■ SUHZ-SW45VA(H)

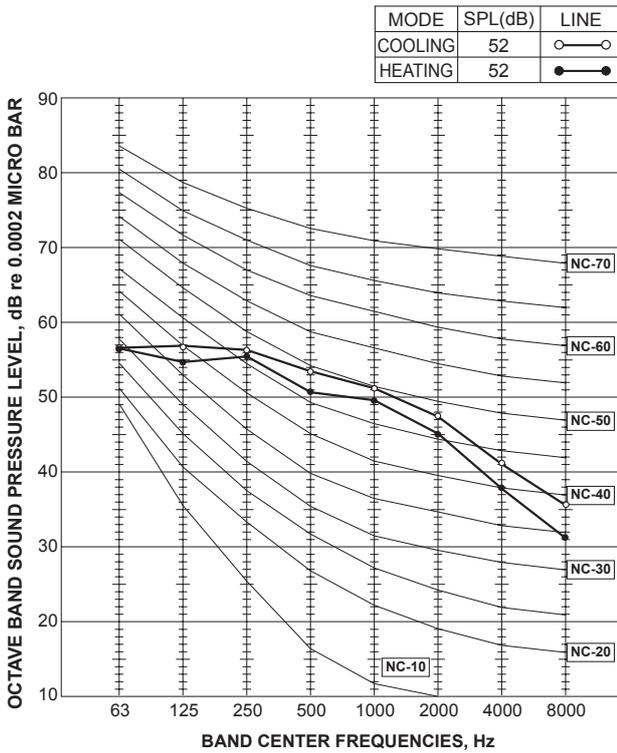

■ PUHZ-SW50VKA(-BS)

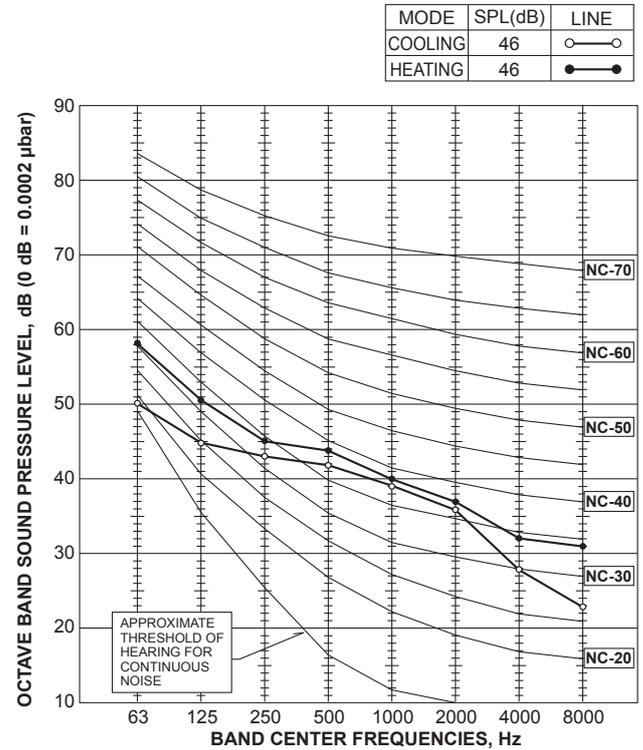

■ PUHZ-SW75VHA(-BS)

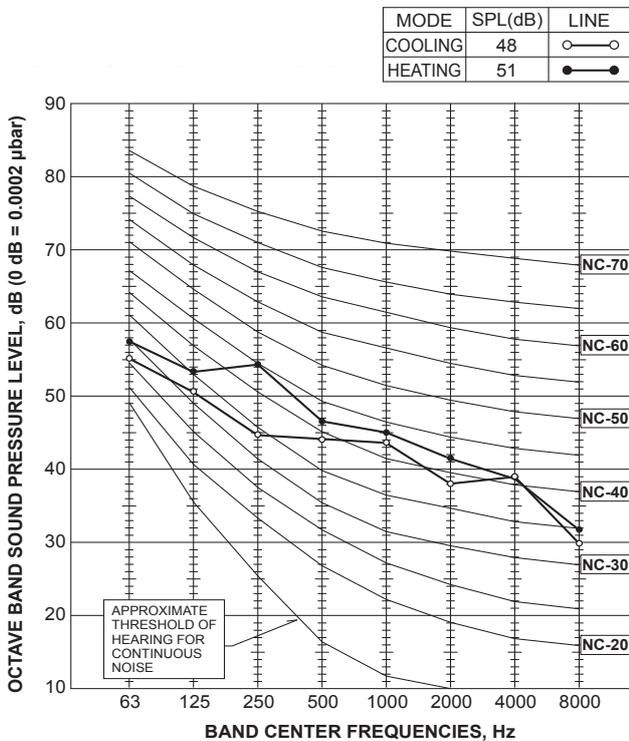

<Notes>

- 1) Sound data is taken when the system is running stably.
- 2) Relatively large noise could be heard transiently in the case 4-way valve, or LEV operates.

PUHZ-SW100VHA(-BS) PUHZ-SW100YHA(-BS)

MODE	SPL(dB)	LINE
COOLING	50	○—○
HEATING	54	●—●

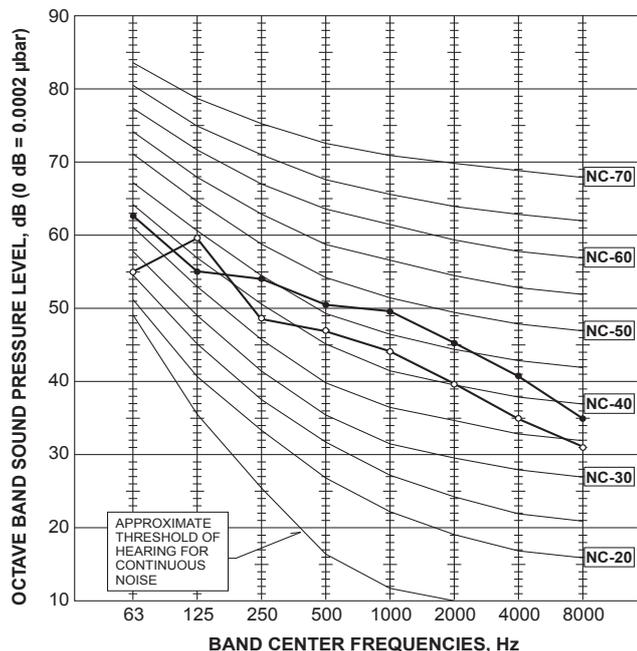

PUHZ-SW120VHA(-BS) PUHZ-SW120YHA(-BS)

MODE	SPL(dB)	LINE
COOLING	51	○—○
HEATING	54	●—●

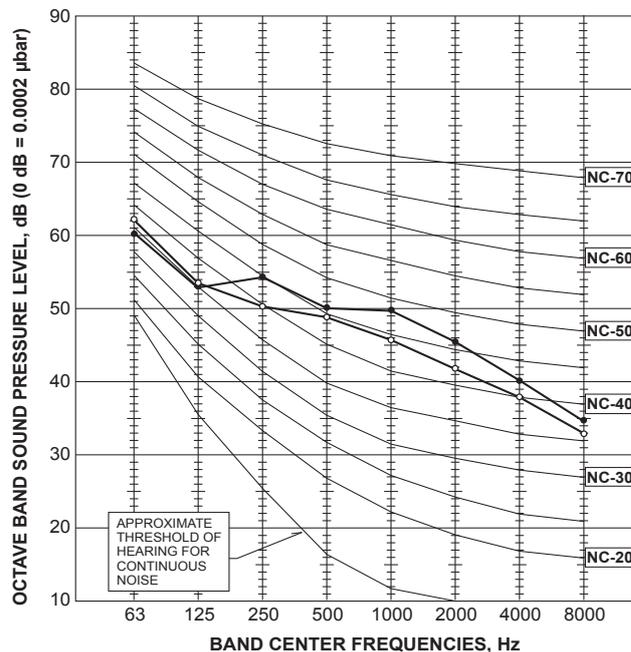

PUHZ-SW160YKA(-BS)

MODE	SPL(dB)	LINE
COOLING	58	○—○
HEATING	62	●—●

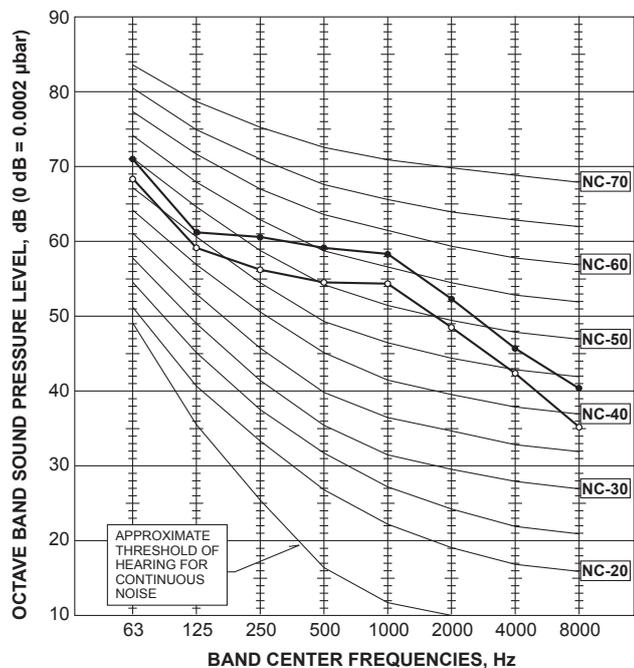

PUHZ-SW200YKA(-BS)

MODE	SPL(dB)	LINE
COOLING	60	○—○
HEATING	62	●—●

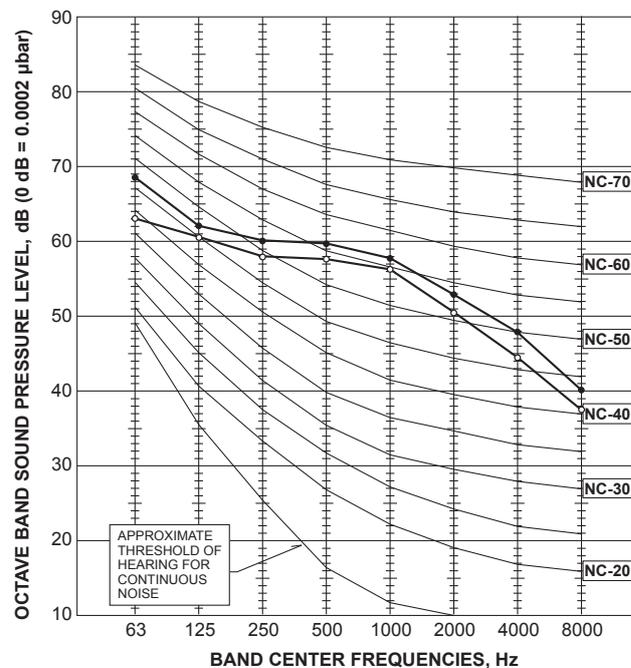

<Notes>

- 1) Sound data is taken when the system is running stably.
- 2) Relatively large noise could be heard transiently in the case 4-way valve, or LEV operates.

PUHZ-SW75VAA(-BS) PUHZ-SW75YAA(-BS)

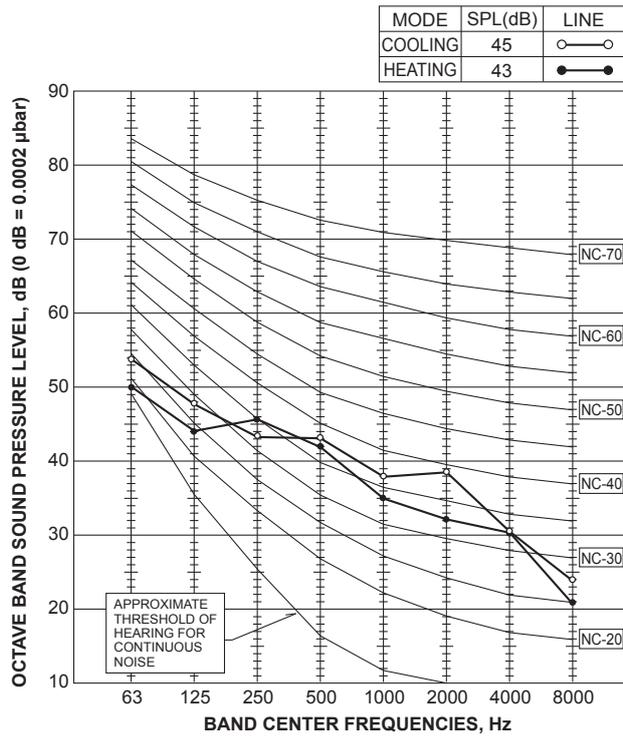

PUHZ-SW100VAA(-BS) PUHZ-SW100YAA(-BS)

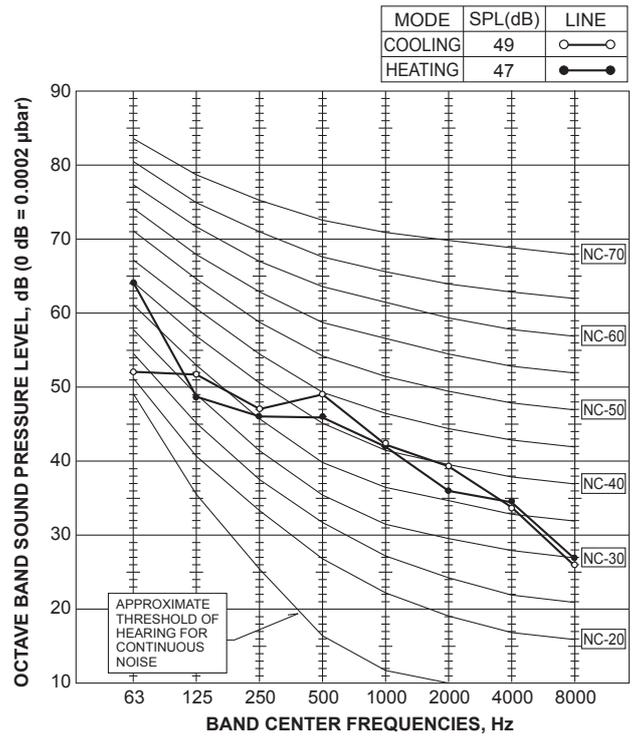

PUHZ-FRP71VHA2

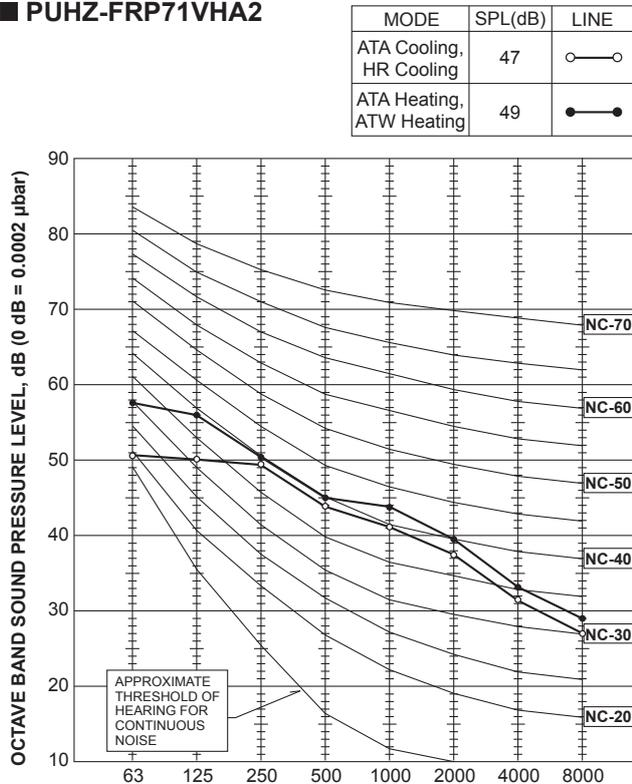

PUHZ-SHW80VHA(-BS) PUHZ-SHW112VHA(-BS) PUHZ-SHW112/140YHA(-BS)

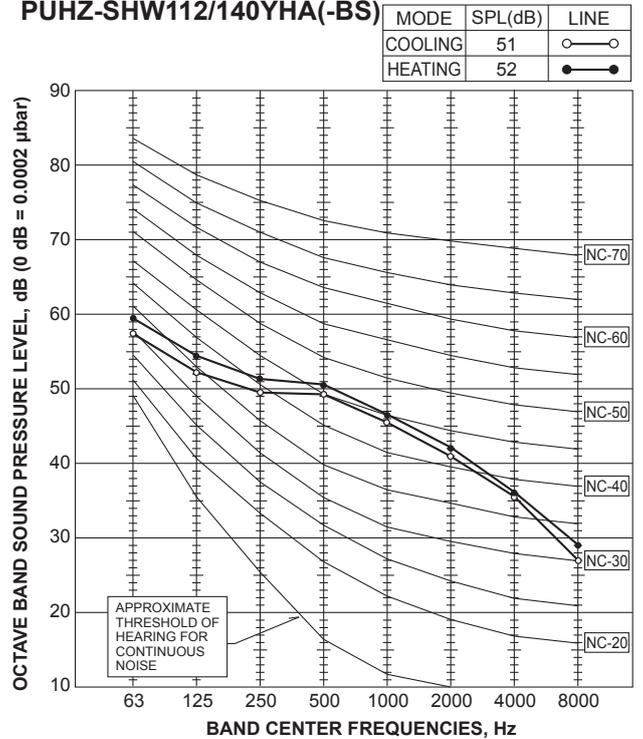

<Notes>

- 1) Sound data is taken when the system is running stably.
- 2) Relatively large noise could be heard transiently in the case 4-way valve, or LEV operates.

PUHZ-SHW230YKA2

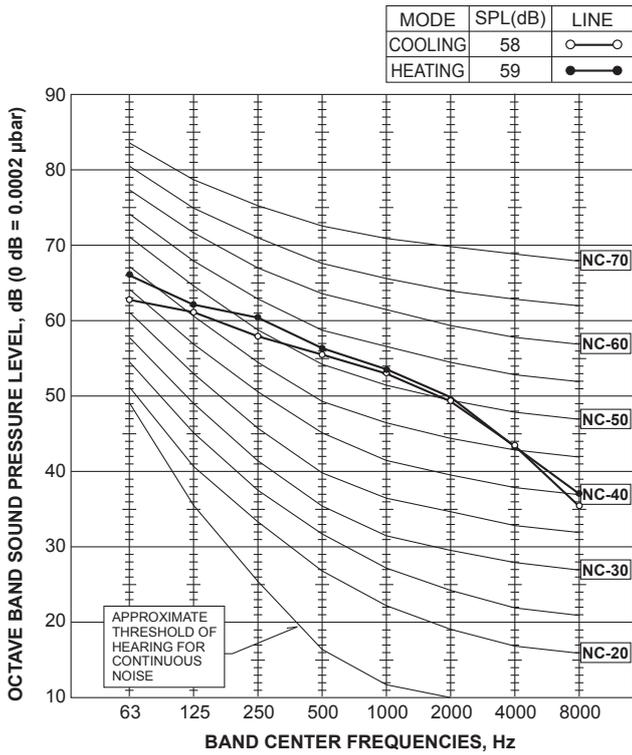

PUHZ-SHW80VAA(-BS) PUHZ-SHW80YAA(-BS)

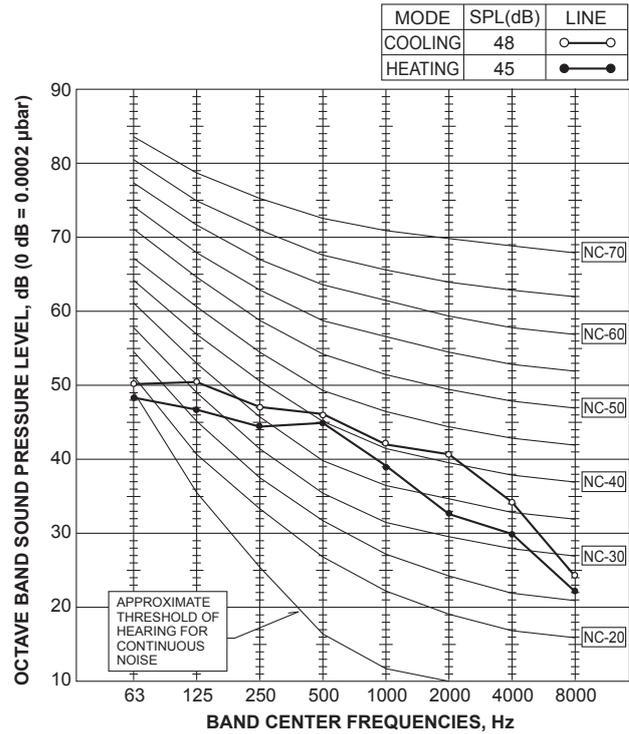

PUHZ-SHW112VAA(-BS) PUHZ-SHW112YAA(-BS)

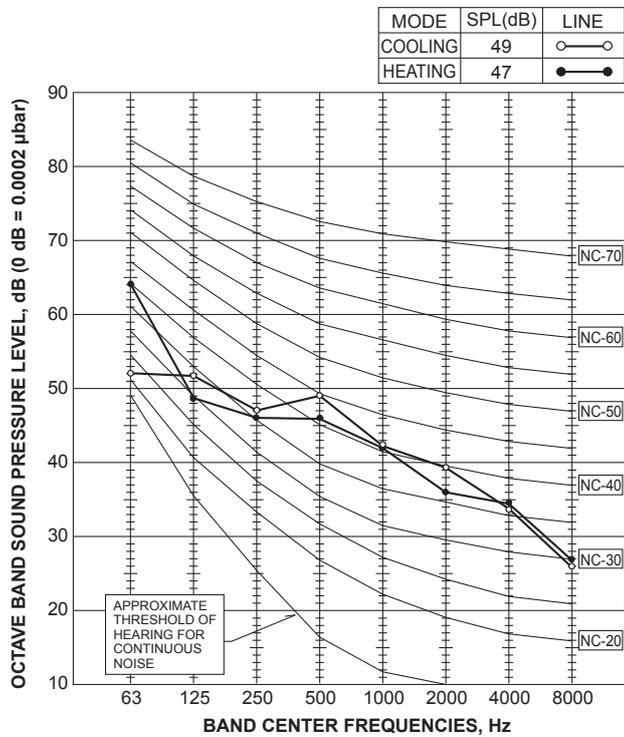

<Notes>

- 1) Sound data is taken when the system is running stably.
- 2) Relatively large noise could be heard transiently in the case 4-way valve, or LEV operates.

■ PUMY-P112VKM4(-BS)
PUMY-P112YKM4(-BS)
PUMY-P112YKME4(-BS)

MODE	SPL(dB)	LINE
COOLING	49	○—○
HEATING	51	●—●

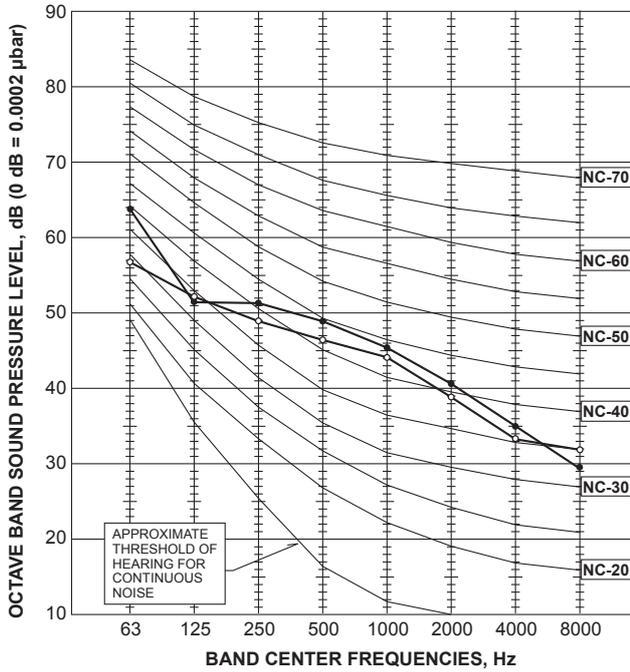

■ PUMY-P125VKM4(-BS)
PUMY-P125YKM4(-BS)
PUMY-P125YKME4(-BS)

MODE	SPL(dB)	LINE
COOLING	50	○—○
HEATING	52	●—●

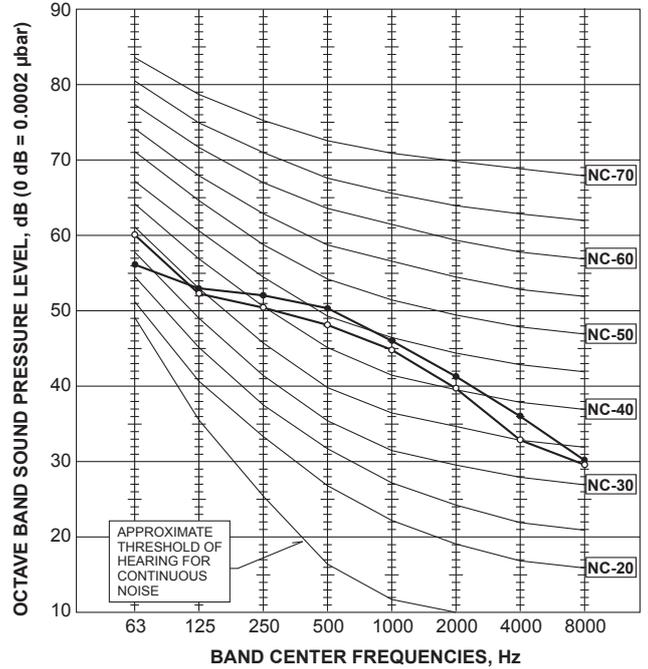

■ PUMY-P140VKM4(-BS)
PUMY-P140YKM4(-BS)
PUMY-P140YKME4(-BS)

MODE	SPL(dB)	LINE
COOLING	51	○—○
HEATING	53	●—●

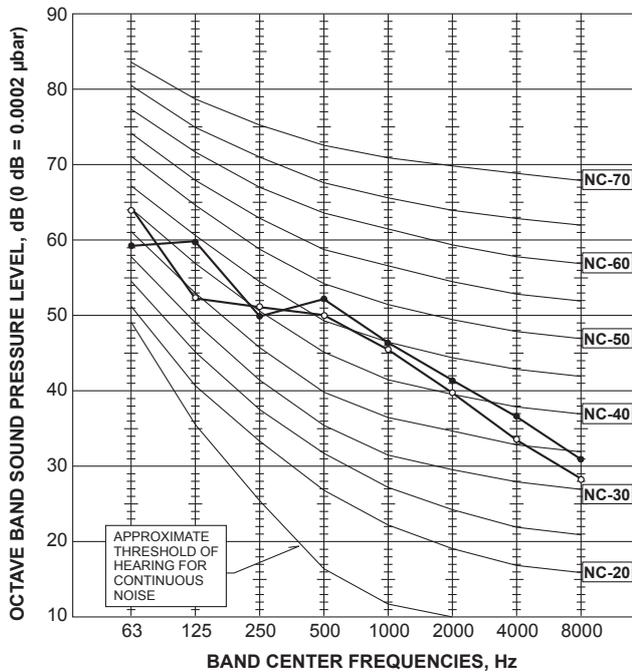

<Notes>

- 1) Sound data is taken when the system is running stably.
- 2) Relatively large noise could be heard transiently in the case 4-way valve, or LEV operates.

Annotation and measurement condition

Outdoor unit

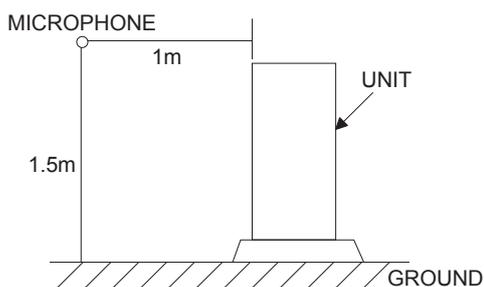

<Notes>

- 1) Sound data is taken when the system is running stably.
- 2) Relatively large noise could be heard transiently in the case 4-way valve, or LEV operates.
- 3) Sound reflection from ground and surrounding walls is not considered.

■ PUAZ-W50VHA2(-BS)

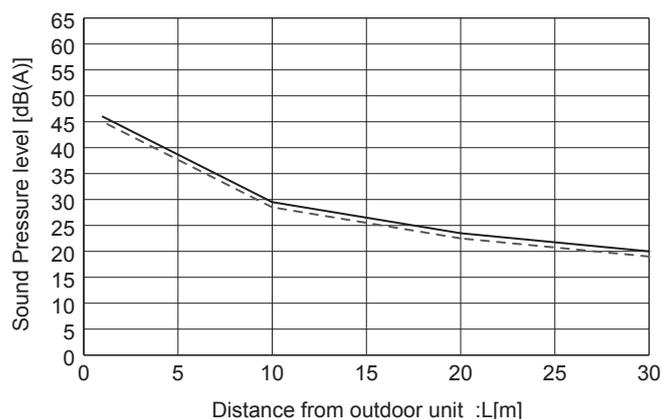

■ PUAZ-W85VHA2(-BS)

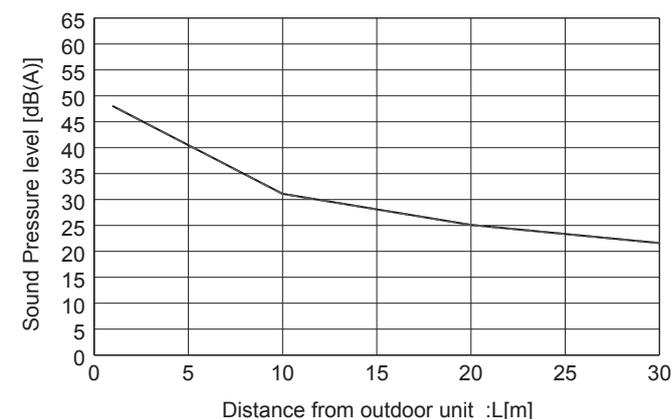

■ PUAZ-W85VAA
PUAZ-W85YAA

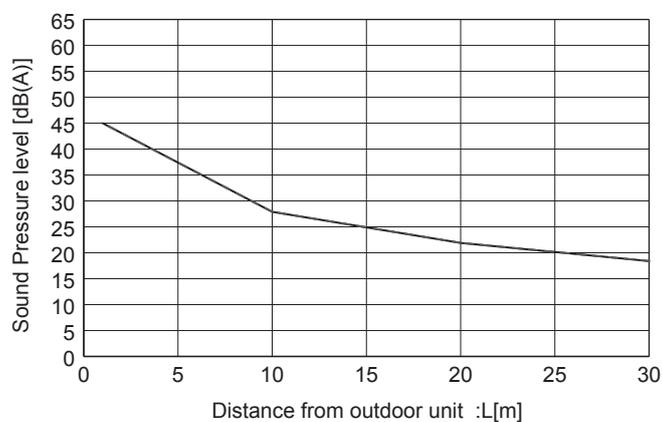

■ PUAZ-W112VAA
PUAZ-W112YAA

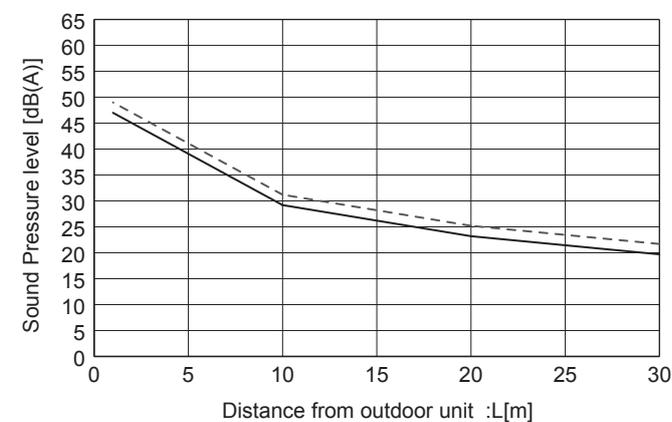

■ PUAZ-W112VHA(-BS)
PUAZ-HW112YHA2(-BS) PUAZ-HW140VHA2(-BS)
PUAZ-HW140YHA2(-BS)

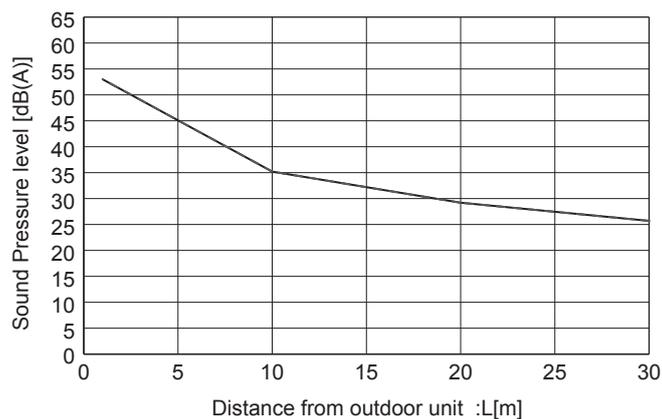

Cooling - - - - -
Heating ————

■ SUHZ-SW45VA(H)

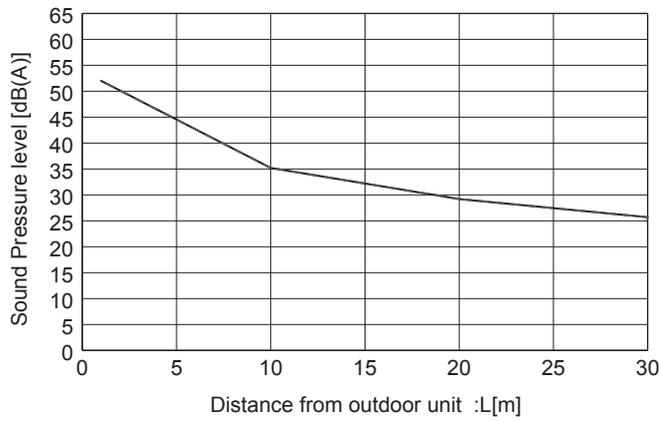

■ PUIZ-SW50VKA(-BS)

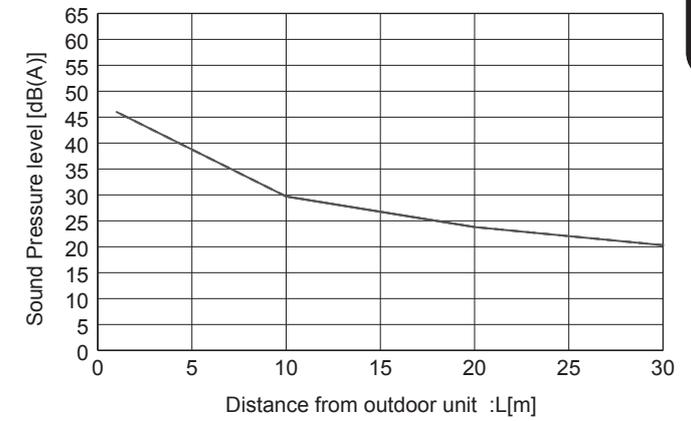

■ PUIZ-SW75VHA(-BS)

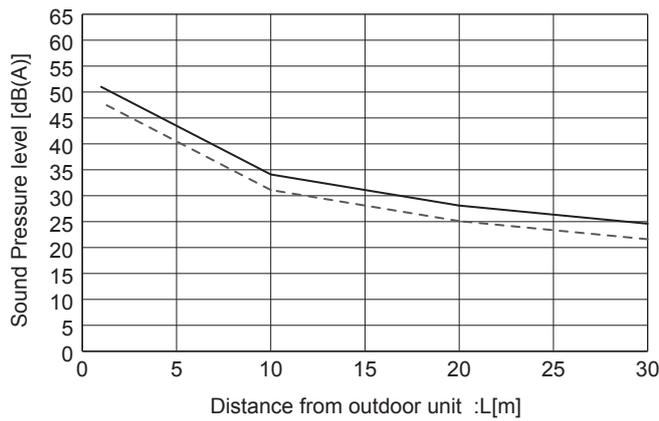

■ PUIZ-SW100VHA(-BS)
PUIZ-SW100YHA(-BS)

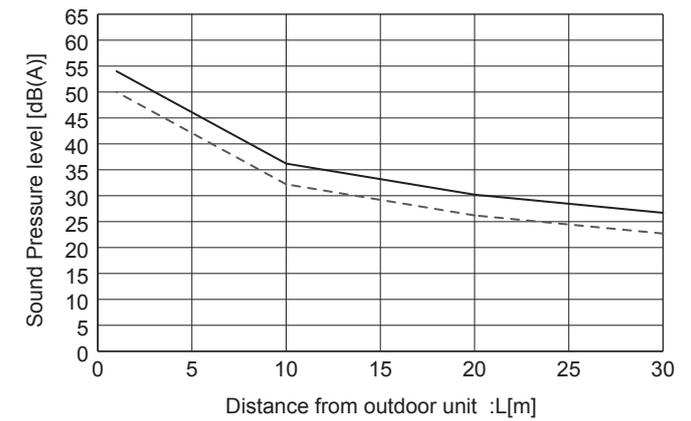

■ PUIZ-SW120VHA(-BS)
PUIZ-SW120YHA(-BS)

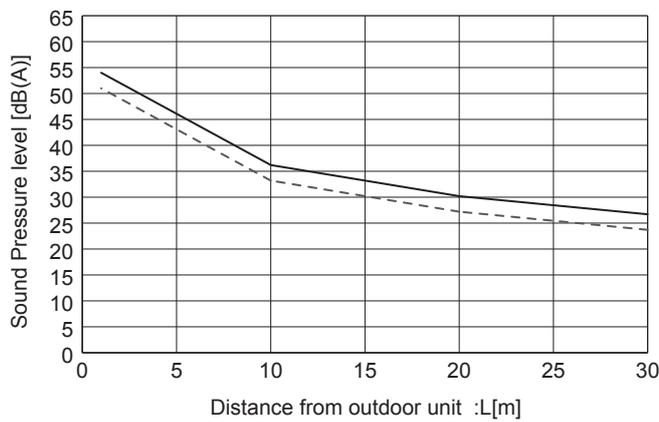

■ PUIZ-SW160YKA(-BS)

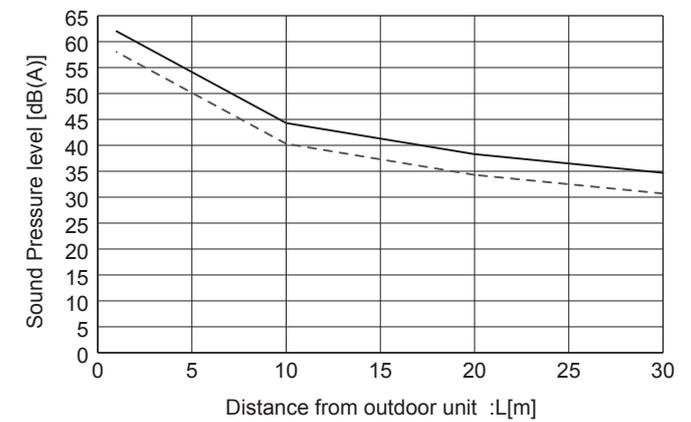

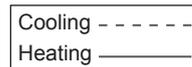

■ PUAZ-SW200YKA(-BS)

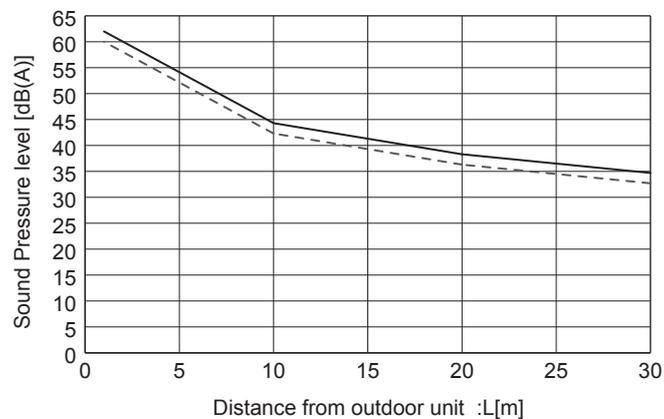

■ PUAZ-SW75VAA(-BS)
PUAZ-SW75YAA(-BS)

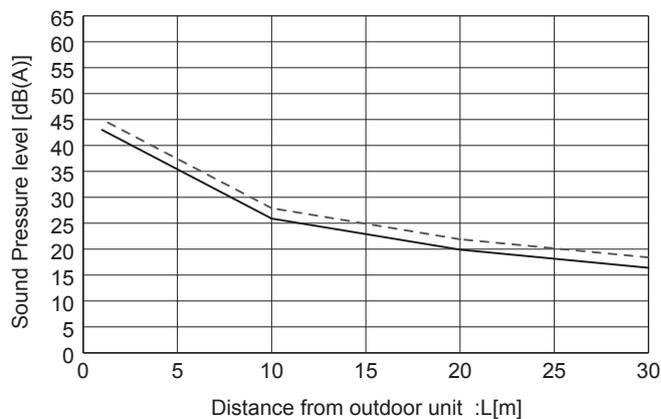

■ PUAZ-SW100VAA(-BS)
PUAZ-SW100YAA(-BS)

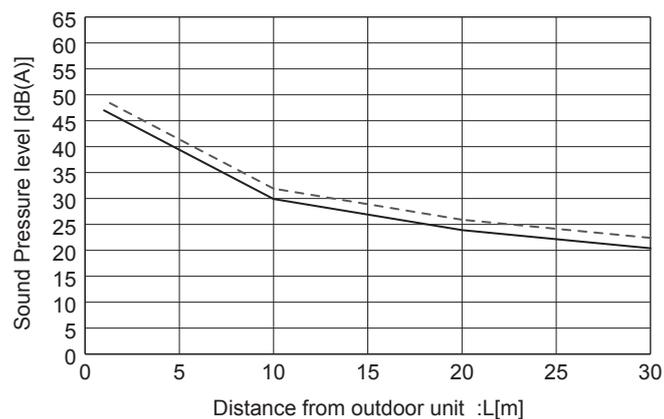

■ PUAZ-FRP71VHA2

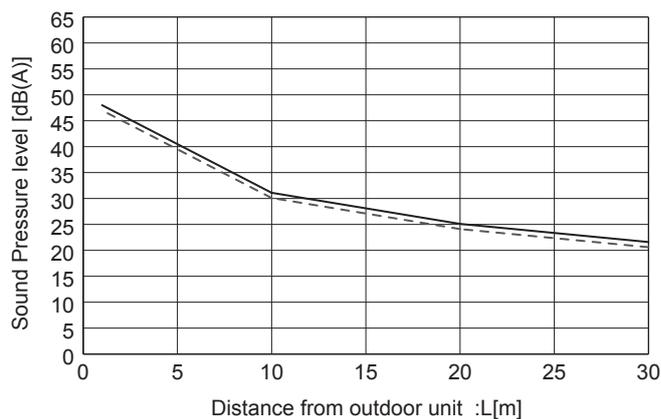

■ PUAZ-SHW80/112VHA(-BS)
PUAZ-SHW112/140YHA(-BS)

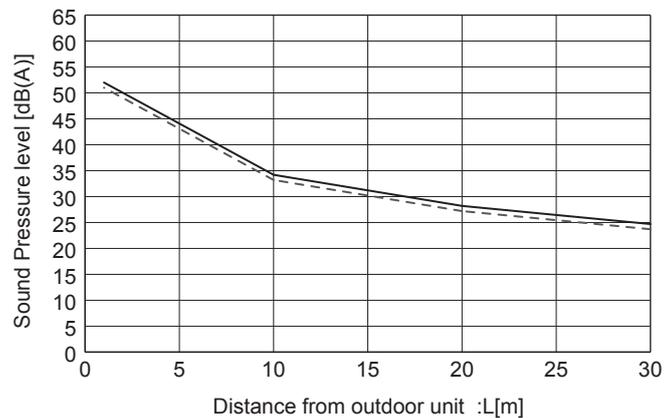

■ PUAZ-SHW230YKA2

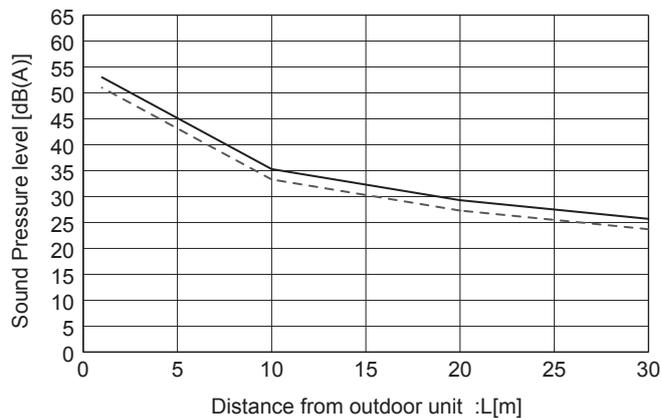

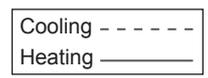

■ PUAZ-SHW80VAA(-BS)
PUAZ-SHW80YAA(-BS)

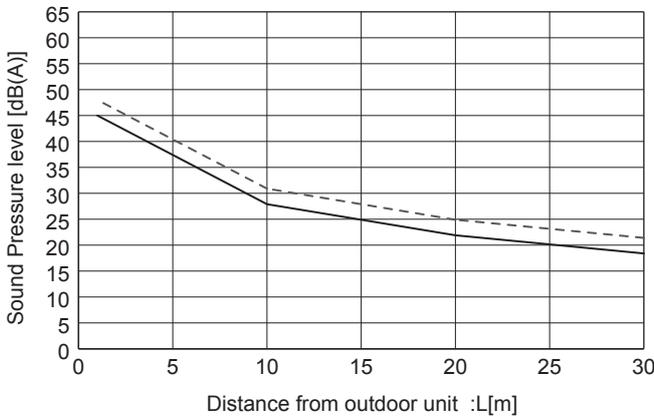

■ PUAZ-SHW112VAA(-BS)
PUAZ-SHW112YAA(-BS)

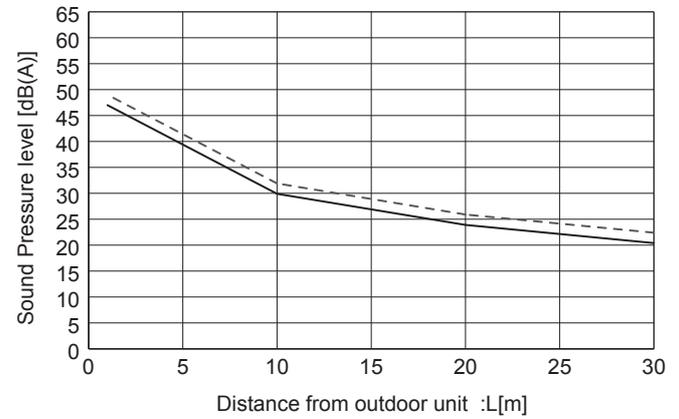

■ PUMY-P112VKM4(-BS)
PUMY-P112YKM4(-BS)
PUMY-P112YKME4(-BS)

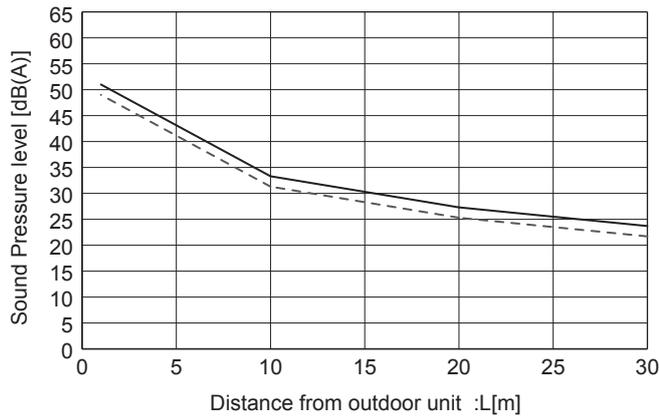

■ PUMY-P125VKM4(-BS)
PUMY-P125YKM4(-BS)
PUMY-P125YKME4(-BS)

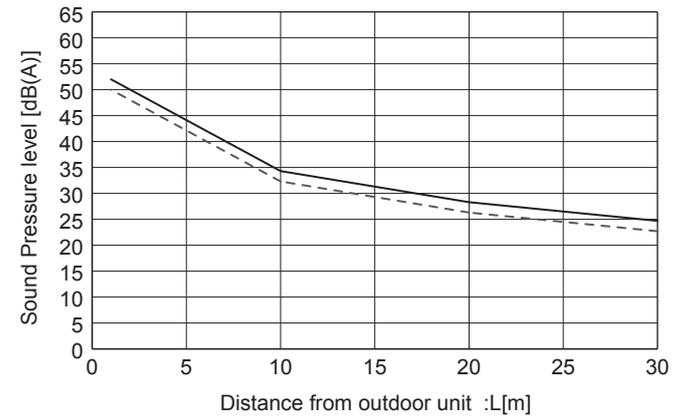

■ PUMY-P140VKM4(-BS)
PUMY-P140YKM4(-BS)
PUMY-P140YKME4(-BS)

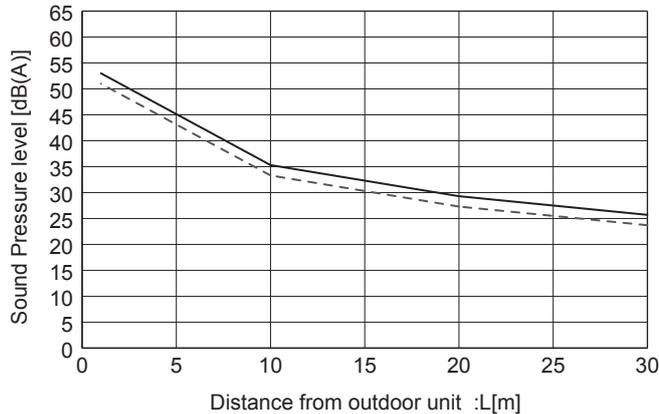

1.Type:

2.Model name:

3.Specification

- | | |
|---|---|
| (1) Unit mass | W= <input type="text" value="64"/> kg |
| (2) Anchor bolt | |
| 1.The total number of bolts | N= <input type="text" value="4"/> |
| 2.The size and shape | "=M <input type="text" value="10"/> type |
| 3.The axis section area per one bolt | A= <input type="text" value="78"/> mm ² = <input type="text" value="78 × 10<sup>-6"/> "/> m ² |
| 4.The total number of bolts in one side which be pulled stronger when the unit inverted | Nt= <input type="text" value="2"/> |
| (3) The height between the installing surface and the center of gravity of the unit | Hg= <input type="text" value="320"/> mm= <input type="text" value="0.320"/> m |
| (4) The bolt-span from the examination angle | L= <input type="text" value="370"/> mm= <input type="text" value="0.370"/> m |
| (5) The distance between the center of bolt and the center of gravity of the unit | Lg= <input type="text" value="190"/> mm(Lg ≤ L/2)= <input type="text" value="0.190"/> m |

4.The examination calculation (by rounding off to the first decimal place of each item)

- | | |
|--|--|
| (1) The horizontal seismic coefficient for designing | Kh= <input type="text" value="1.0"/> |
| (2) The vertical seismic coefficient for designing | Kv=Kh/2= <input type="text" value="0.5"/> |
| (3) The horizontal earthquake forces for designing | Fh=Kh·W·9.8= <input type="text" value="627.2"/> N |
| (4) The vertical earthquake forces for designing | Fv=Kv·W·9.8= <input type="text" value="313.6"/> N |
| (5) The withdrawal strength of the anchor bolt | $R_b = \frac{F_h \cdot H_g - (W \cdot 9.8 - F_v) \cdot L_g}{L \cdot N_t}$ = <input type="text" value="190.7"/> N |
| (6) The shear forces of the anchor bolt | Q=Fh/N= <input type="text" value="156.8"/> N |
| (7) The stress arising to the anchor bolt | |
| 1.The tensile stress | $\sigma = R_b/A =$ <input type="text" value="2.4"/> MPa < ft=176.4MPa |
| 2.The shearing stress | $\tau = Q/A =$ <input type="text" value="2.0"/> MPa < fs=132.3MPa |
| 3.The stress when affected by both the shearing and the tensile at the same time | $f_{ts} = 1.4\sigma + 1.6\tau =$ <input type="text" value="243.7"/> MPa |
| | $\sigma =$ <input type="text" value="2.4"/> MPa < fts= <input type="text" value="176.4"/> MPa |
| (8) The construction way of the anchor bolt | |
| 1.The construction way of the anchor bolt | = <input type="text" value="Boxed J type anchor"/> |
| 2.The thickness of the concrete | = <input type="text" value="120"/> mm= <input type="text" value="0.120"/> m |
| 3.The length of buried part of bolt | = <input type="text" value="70"/> mm= <input type="text" value="0.070"/> m |
| 4.The permissible withdrawal weight | Ta= <input type="text" value="3136"/> N > Rb= <input type="text" value="190.7"/> N |

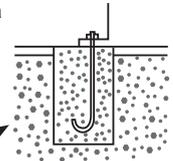

Since the results from the examination above, the anchor bolt has enough strength.

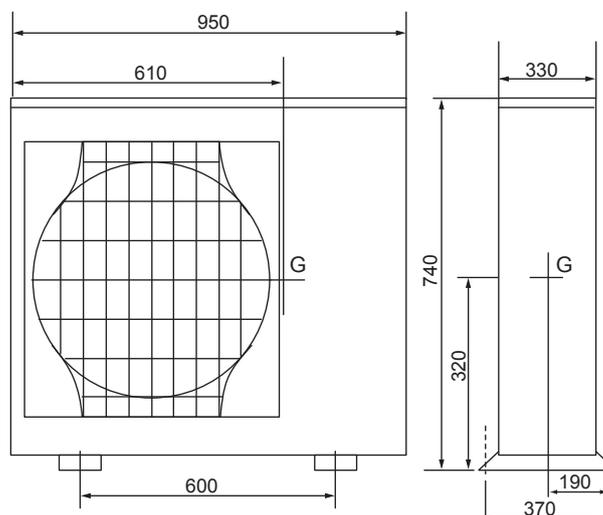

1.Type:

2.Model name:

3.Specification

- | | |
|---|---|
| (1) Unit mass | W= <input type="text" value="79"/> kg |
| (2) Anchor bolt | |
| 1.The total number of bolts | N= <input type="text" value="4"/> |
| 2.The size and shape | "=M <input type="text" value="10"/> type |
| 3.The axis section area per one bolt | A= <input type="text" value="78"/> mm ² = <input type="text" value="78 × 10<sup>-6"/> "/> m ² |
| 4.The total number of bolts in one side which be pulled stronger when the unit inverted | Nt= <input type="text" value="2"/> |
| (3) The height between the installing surface and the center of gravity of the unit | Hg= <input type="text" value="400"/> mm= <input type="text" value="0.400"/> m |
| (4) The bolt-span from the examination angle | L= <input type="text" value="370"/> mm= <input type="text" value="0.370"/> m |
| (5) The distance between the center of bolt and the center of gravity of the unit | Lg= <input type="text" value="180"/> mm(Lg ≤ L/2)= <input type="text" value="0.180"/> m |

4.The examination calculation (by rounding off to the first decimal place of each item)

- | | |
|--|--|
| (1) The horizontal seismic coefficient for designing | Kh= <input type="text" value="1.0"/> |
| (2) The vertical seismic coefficient for designing | Kv=Kh/2= <input type="text" value="0.5"/> |
| (3) The horizontal earthquake forces for designing | Fh=Kh·W·9.8= <input type="text" value="774.2"/> N |
| (4) The vertical earthquake forces for designing | Fv=Kv·W·9.8= <input type="text" value="387.1"/> N |
| (5) The withdrawal strength of the anchor bolt | $R_b = \frac{F_h \cdot H_g - (W \cdot 9.8 - F_v) \cdot L_g}{L \cdot N_t}$ = <input type="text" value="324.3"/> N |
| (6) The shear forces of the anchor bolt | Q=Fh/N= <input type="text" value="193.6"/> N |
| (7) The stress arising to the anchor bolt | |
| 1.The tensile stress | $\sigma = R_b/A =$ <input type="text" value="4.2"/> MPa < ft=176.4MPa |
| 2.The shearing stress | $\tau = Q/A =$ <input type="text" value="2.5"/> MPa < fs=132.3MPa |
| 3.The stress when affected by both the shearing and the tensile at the same time | $f_{ts} = 1.4\tau - 1.6\sigma =$ <input type="text" value="243.0"/> MPa
$\sigma =$ <input type="text" value="4.2"/> MPa < fts= <input type="text" value="176.4"/> MPa |
| (8) The construction way of the anchor bolt | |
| 1.The construction way of the anchor bolt | = <input type="text" value="Boxed J type anchor"/> |
| 2.The thickness of the concrete | = <input type="text" value="120"/> mm= <input type="text" value="0.120"/> m |
| 3.The length of buried part of bolt | = <input type="text" value="70"/> mm= <input type="text" value="0.070"/> m |
| 4.The permissible withdrawal weight | Ta= <input type="text" value="3136"/> N > Rb= <input type="text" value="324.3"/> N |

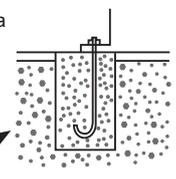

Since the results from the examination above, the anchor bolt has enough strength.

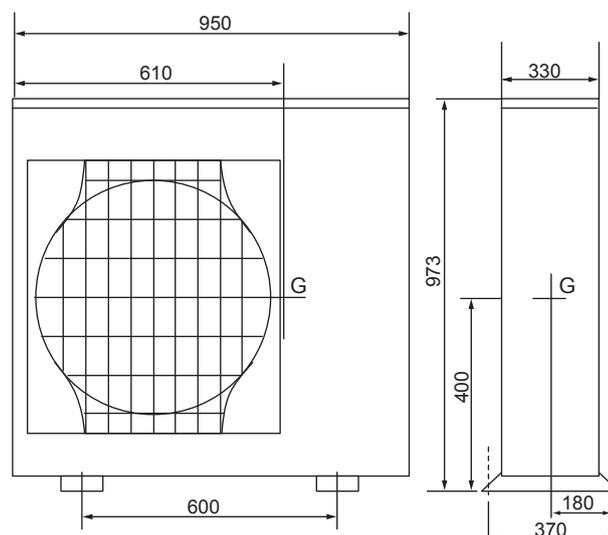

1.Type:

2.Model name:

3.Specification

- | | | | |
|---|-----|----------------------------------|--|
| (1) Unit mass | W= | <input type="text" value="133"/> | kg |
| (2) Anchor bolt | | | |
| 1.The total number of bolts | N= | <input type="text" value="4"/> | |
| 2.The size and shape | "=M | <input type="text" value="10"/> | type |
| 3.The axis section area per one bolt. | A= | <input type="text" value="78"/> | mm ² = <input type="text" value="78"/> ×10 ⁻⁶ m ² |
| 4.The total number of bolts in one side which be pulled stronger when the unit inverted | Nt= | <input type="text" value="2"/> | |
| (3) The height between the installing surface and the center of gravity of the unit | Hg= | <input type="text" value="590"/> | mm= <input type="text" value="0.590"/> m |
| (4) The bolt-span from the examination angle | L= | <input type="text" value="370"/> | mm= <input type="text" value="0.370"/> m |
| (5) The distance between the center of bolt and the center of gravity of the unit | Lg= | <input type="text" value="180"/> | mm(Lg ≤ L/2)= <input type="text" value="0.180"/> m |

4.The examination calculation (by rounding off to the first decimal place of each item)

- | | | | | |
|---|---|--|--|-----|
| (1) The horizontal seismic coefficient for designing | Kh= | <input type="text" value="1.0"/> | | |
| (2) The vertical seismic coefficient for designing | Kv=Kh/2= | <input type="text" value="0.5"/> | | |
| (3) The horizontal earthquake forces for designing | Fh=Kh·W·9.8= | <input type="text" value="1303.4"/> | N | |
| (4) The vertical earthquake forces for designing | Fv=Kv·W·9.8= | <input type="text" value="651.7"/> | N | |
| (5) The withdrawal strength of the anchor bolt | $R_b = \frac{F_h \cdot H_g \cdot (W \cdot 9.8 - F_v) \cdot L_g}{L \cdot N_t}$ | = | <input type="text" value="880.7"/> | N |
| (6) The shear forces of the anchor bolt | Q=Fh/N= | <input type="text" value="325.9"/> | N | |
| (7) The stress arising to the anchor bolt | | | | |
| 1.The tensile stress | $\sigma = R_b/A =$ | <input type="text" value="11.3"/> | MPa < ft=176.4MPa | |
| 2.The shearing stress | $\tau = Q/A =$ | <input type="text" value="4.2"/> | Pa < fs=132.3MPa | |
| 3.The stress when affected by both the shearing and the tensile at the same time. | $f_{ts} = 1.4\sigma + 1.6\tau =$ | <input type="text" value="240.3"/> | MPa | |
| | $\sigma =$ | <input type="text" value="11.3"/> | MPa < $f_{ts} =$ | |
| | | | <input type="text" value="176.4"/> | MPa |
| (8) The construction way of the anchor bolt | | | MPa | |
| 1.The construction way of the anchor bolt | = | <input type="text" value="Boxed J type anchor"/> | | |
| 2.The thickness of the concrete | = | <input type="text" value="120"/> | mm= <input type="text" value="0.120"/> m | |
| 3.The length of buried part of bolt | = | <input type="text" value="70"/> | mm= <input type="text" value="0.070"/> m | |
| 4.The permissible withdrawal weight | Ta= | <input type="text" value="3136"/> | N > Rb= <input type="text" value="880.7"/> | N |

Since the results from the examination above, the anchor bolt has enough strength.

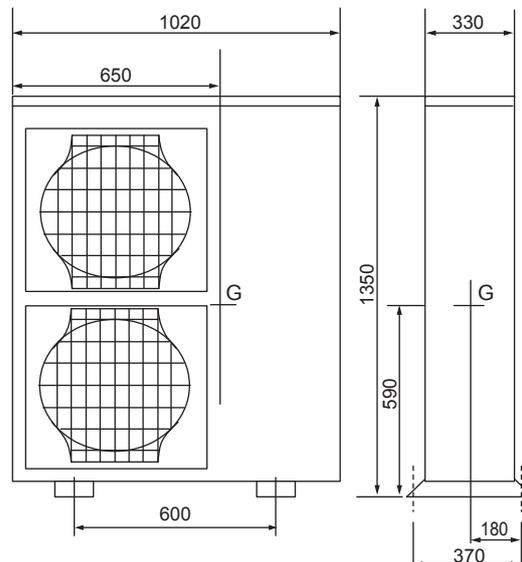

1.Type:

2.Model name:

3.Specification

- | | | | |
|---|-----|----------------------------------|--|
| (1) Unit mass | W= | <input type="text" value="97"/> | kg |
| (2) Anchor bolt | | | |
| 1.The total number of bolts | N= | <input type="text" value="4"/> | |
| 2.The size and shape | "=M | <input type="text" value="10"/> | type |
| 3.The axis section area per one bolt | A= | <input type="text" value="78"/> | mm ² = <input type="text" value="78 × 10<sup>-6"/> "/> m ² |
| 4.The total number of bolts in one side which be pulled stronger when the unit inverted | Nt= | <input type="text" value="2"/> | |
| (3) The height between the installing surface and the center of gravity of the unit | Hg= | <input type="text" value="450"/> | mm = <input type="text" value="0.450"/> m |
| (4) The bolt-span from the examination angle | L= | <input type="text" value="520"/> | mm = <input type="text" value="0.520"/> m |
| (5) The distance between the center of bolt and the center of gravity of the unit | Lg= | <input type="text" value="225"/> | mm(Lg≤L/2)= <input type="text" value="0.225"/> m |

4.The examination calculation (by rounding off to the first decimal place of each item)

- | | | |
|--|---|--|
| (1) The horizontal seismic coefficient for designing | Kh= | <input type="text" value="1.0"/> |
| (2) The vertical seismic coefficient for designing | Kv=Kh/2= | <input type="text" value="0.5"/> |
| (3) The horizontal earthquake forces for designing | Fh=Kh·W·9.8= | <input type="text" value="950.6"/> N |
| (4) The vertical earthquake forces for designing | Fv=Kv·W·9.8= | <input type="text" value="475.3"/> N |
| (5) The withdrawal strength of the anchor bolt | $R_b = \frac{F_h \cdot H_g - (W \cdot 9.8 - F_v) \cdot L_g}{L \cdot N_t}$ | = <input type="text" value="308.5"/> N |
| (6) The shear forces of the anchor bolt | Q=Fh/N= | <input type="text" value="237.7"/> N |

(7) The stress arising to the anchor bolt

- | | | | |
|--|--------------------------------|--|---|
| 1.The tensile stress | $\sigma = R_b/A =$ | <input type="text" value="4.0"/> MPa | < $f_t = 176.4$ MPa |
| 2.The shearing stress | $\tau = Q/A =$ | <input type="text" value="3.0"/> MPa | < $f_s = 132.3$ MPa |
| 3.The stress when affected by both the shearing and the tensile at the same time | $f_{ts} = 1.4\tau + 1.6\sigma$ | <input type="text" value="242.2"/> MPa | < $f_{ts} =$ <input type="text" value="242.2"/> MPa |

$\sigma =$ MPa

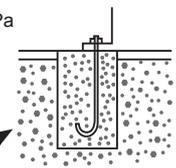

(8) The construction way of the anchor bolt

- | | | |
|---|-----|--|
| 1.The construction way of the anchor bolt | = | <input type="text" value="Boxed J type anchor"/> |
| 2.The thickness of the concrete | = | <input type="text" value="120"/> mm = <input type="text" value="0.120"/> m |
| 3.The length of buried part of bolt | = | <input type="text" value="70"/> mm = <input type="text" value="0.070"/> m |
| 4.The permissible withdrawal weight | Ta= | <input type="text" value="3136"/> N > Rb= <input type="text" value="308"/> N |

Since the results from the examination above, the anchor bolt has enough strength.

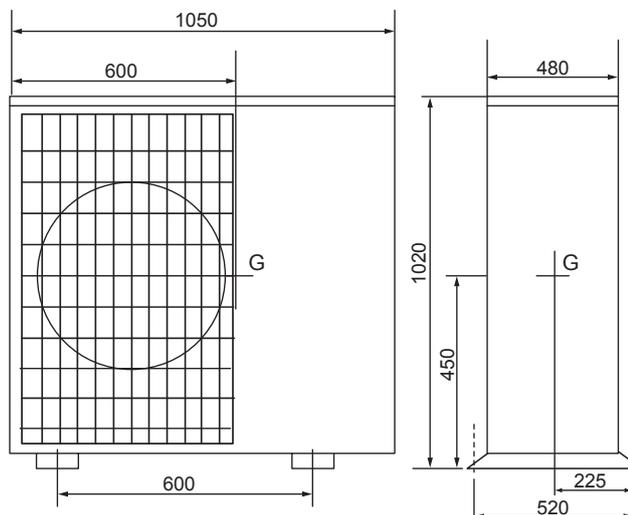

1.Type:

2.Model name:

3.Specification

- | | |
|---|--|
| (1) Unit mass | W= <input type="text" value="110"/> kg |
| (2) Anchor bolt | |
| 1.The total number of bolts | N= <input type="text" value="4"/> |
| 2.The size and shape | "=M <input type="text" value="10"/> type |
| 3.The axis section area per one bolt | A= <input type="text" value="78"/> mm ² = <input type="text" value="78"/> × 10 ⁻⁶ m ² |
| 4.The total number of bolts in one side which be pulled stronger when the unit inverted | Nt= <input type="text" value="2"/> |
| (3) The height between the installing surface and the center of gravity of the unit | Hg= <input type="text" value="450"/> mm= <input type="text" value="0.450"/> m |
| (4) The bolt-span from the examination angle | L= <input type="text" value="520"/> mm= <input type="text" value="0.520"/> m |
| (5) The distance between the center of bolt and the center of gravity of the unit | Lg= <input type="text" value="225"/> mm(Lg≤L/2)= <input type="text" value="0.225"/> m |

4.The examination calculation (by rounding off to the first decimal place of each item)

- | | |
|--|--|
| (1) The horizontal seismic coefficient for designing | Kh= <input type="text" value="1.0"/> |
| (2) The vertical seismic coefficient for designing | Kv=Kh/2= <input type="text" value="0.5"/> |
| (3) The horizontal earthquake forces for designing | Fh=Kh·W·9.8= <input type="text" value="1078.0"/> N |
| (4) The vertical earthquake forces for designing | Fv=Kv·W·9.8= <input type="text" value="539.0"/> N |
| (5) The withdrawal strength of the anchor bolt | $R_b = \frac{F_h \cdot H_g - (W \cdot 9.8 - F_v) \cdot L_g}{L \cdot N_t}$ = <input type="text" value="349.8"/> N |
| (6) The shear forces of the anchor bolt | Q=Fh/N= <input type="text" value="269.5"/> N |
| (7) The stress arising to the anchor bolt | |
| 1.The tensile stress | $\sigma = R_b/A =$ <input type="text" value="4.5"/> MPa < ft=176.4MPa |
| 2.The shearing stress | $\tau = Q/A =$ <input type="text" value="3.5"/> MPa < fs=132.3MPa |
| 3.The stress when affected by both the shearing and the tensile at the same time | $f_t s = 1.4f_t - 1.6\tau =$ <input type="text" value="241.4"/> MPa |
| | $\sigma =$ <input type="text" value="4.5"/> MPa < $f_t s =$ <input type="text" value="241.4"/> MPa |
| (8) The construction way of the anchor bolt | |
| 1.The construction way of the anchor bolt | = <input type="text" value="Boxed J type anchor"/> |
| 2.The thickness of the concrete | = <input type="text" value="120"/> mm= <input type="text" value="0.120"/> m |
| 3.The length of buried part of bolt | = <input type="text" value="70"/> mm= <input type="text" value="0.070"/> m |
| 4.The permissible withdrawal weight | Ta= <input type="text" value="3136"/> N > Rb= <input type="text" value="350"/> N |

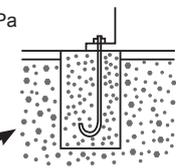

Since the results from the examination above, the anchor bolt has enough strength.

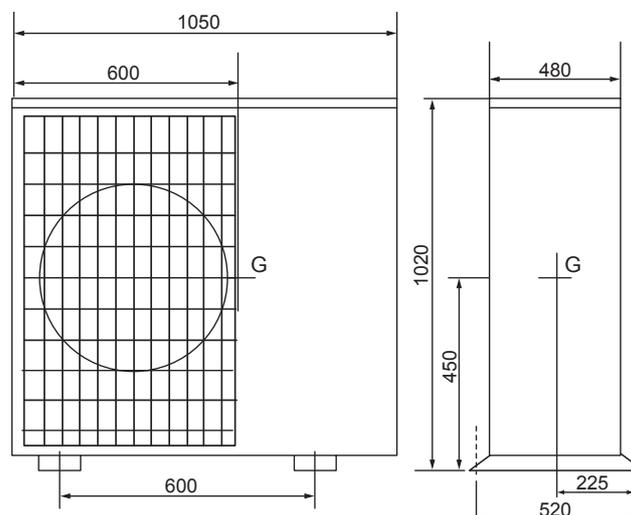

1.Type:

2.Model name:

3.Specification

- | | | | |
|---|-----|----------------------------------|---|
| (1) Unit mass | W= | <input type="text" value="118"/> | kg |
| (2) Anchor bolt | | | |
| 1.The total number of bolts | N= | <input type="text" value="4"/> | |
| 2.The size and shape | "=M | <input type="text" value="10"/> | type |
| 3.The axis section area per one bolt | A= | <input type="text" value="78"/> | mm ² = <input type="text" value="78"/> × 10 ⁻⁶ m ² |
| 4.The total number of bolts in one side which be pulled stronger when the unit inverted | Nt= | <input type="text" value="2"/> | |
| (3) The height between the installing surface and the center of gravity of the unit | Hg= | <input type="text" value="450"/> | mm= <input type="text" value="0.450"/> m |
| (4) The bolt-span from the examination angle | L= | <input type="text" value="520"/> | mm= <input type="text" value="0.520"/> m |
| (5) The distance between the center of bolt and the center of gravity of the unit | Lg= | <input type="text" value="225"/> | mm(Lg≤L/2)= <input type="text" value="0.225"/> m |

4.The examination calculation (by rounding off to the first decimal place of each item)

- | | | | | |
|--|---|-------------------------------------|---|---|
| (1) The horizontal seismic coefficient for designing | Kh= | <input type="text" value="1.0"/> | | |
| (2) The vertical seismic coefficient for designing | Kv=Kh/2= | <input type="text" value="0.5"/> | | |
| (3) The horizontal earthquake forces for designing | Fh=Kh·W·9.8= | <input type="text" value="1156.4"/> | N | |
| (4) The vertical earthquake forces for designing | Fv=Kv·W·9.8= | <input type="text" value="578.2"/> | N | |
| (5) The withdrawal strength of the anchor bolt | $R_b = \frac{F_h \cdot H_g - (W \cdot 9.8 - F_v) \cdot L_g}{L \cdot N_t}$ | = | <input type="text" value="375.3"/> | N |
| (6) The shear forces of the anchor bolt | Q=Fh/N= | <input type="text" value="289.1"/> | N | |
| (7) The stress arising to the anchor bolt | | | | |
| 1.The tensile stress | $\sigma = R_b/A =$ | <input type="text" value="4.8"/> | MPa < ft=176.4MPa | |
| 2.The shearing stress | $\tau = Q/A =$ | <input type="text" value="3.7"/> | MPa < fs=132.3MPa | |
| 3.The stress when affected by both the shearing and the tensile at the same time | $f_{ts} = 1.4\tau - 1.6\sigma$ | <input type="text" value="241.0"/> | MPa | |
| | $\sigma =$ | <input type="text" value="4.8"/> | MPa < fts= <input type="text" value="241.0"/> | |

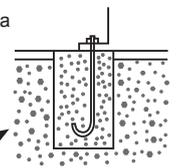

- | | | | |
|---|-----|--|--|
| (8) The construction way of the anchor bolt | | | |
| 1.The construction way of the anchor bolt | = | <input type="text" value="Boxed J type anchor"/> | |
| 2.The thickness of the concrete | = | <input type="text" value="120"/> | mm= <input type="text" value="0.120"/> m |
| 3.The length of buried part of bolt | = | <input type="text" value="70"/> | mm= <input type="text" value="0.070"/> m |
| 4.The permissible withdrawal weight | Ta= | <input type="text" value="3136"/> | N > Rb= <input type="text" value="375"/> N |

Since the results from the examination above, the anchor bolt has enough strength.

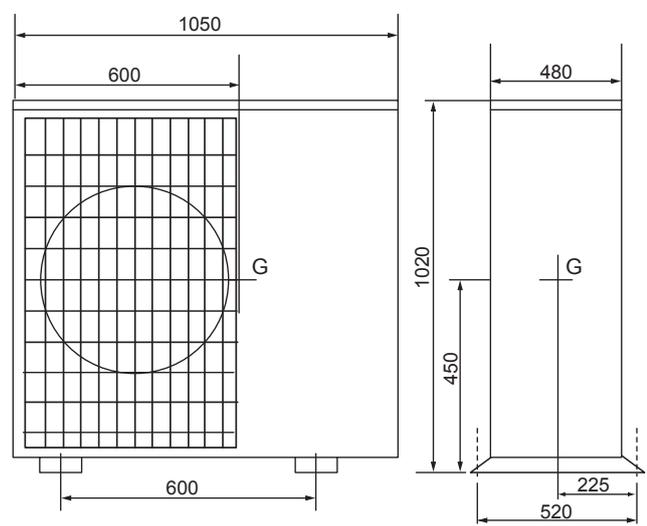

1.Type:

2.Model name:

3.Specification

- | | |
|---|---|
| (1) Unit mass | W= <input type="text" value="131"/> kg |
| (2) Anchor bolt | |
| 1.The total number of bolts | N= <input type="text" value="4"/> |
| 2.The size and shape | "=M <input type="text" value="10"/> type |
| 3.The axis section area per one bolt | A= <input type="text" value="78"/> mm ² = <input type="text" value="78 × 10<sup>-6"/> "/> m ² |
| 4.The total number of bolts in one side which be pulled stronger when the unit inverted | Nt= <input type="text" value="2"/> |
| (3) The height between the installing surface and the center of gravity of the unit | Hg= <input type="text" value="450"/> mm= <input type="text" value="0.450"/> m |
| (4) The bolt-span from the examination angle | L= <input type="text" value="520"/> mm= <input type="text" value="0.520"/> m |
| (5) The distance between the center of bolt and the center of gravity of the unit | Lg= <input type="text" value="225"/> mm(Lg≤L/2)= <input type="text" value="0.225"/> m |

4.The examination calculation (by rounding off to the first decimal place of each item)

- | | |
|--|--|
| (1) The horizontal seismic coefficient for designing | Kh= <input type="text" value="1.0"/> |
| (2) The vertical seismic coefficient for designing | Kv=Kh/2= <input type="text" value="0.5"/> |
| (3) The horizontal earthquake forces for designing | Fh=Kh·W·9.8= <input type="text" value="1283.8"/> N |
| (4) The vertical earthquake forces for designing | Fv=Kv·W·9.8= <input type="text" value="641.9"/> N |
| (5) The withdrawal strength of the anchor bolt | $R_b = \frac{F_h \cdot H_g - (W \cdot 9.8 - F_v) \cdot L_g}{L \cdot N_t}$ = <input type="text" value="416.6"/> N |
| (6) The shear forces of the anchor bolt | Q=Fh/N= <input type="text" value="321.0"/> N |
| (7) The stress arising to the anchor bolt | |
| 1.The tensile stress | $\sigma = R_b/A =$ <input type="text" value="5.3"/> MPa < ft=176.4MPa |
| 2.The shearing stress | $\tau = Q/A =$ <input type="text" value="4.1"/> MPa < fs=132.3MPa |
| 3.The stress when affected by both the shearing and the tensile at the same time | $f_t s = 1.4f_t - 1.6\tau =$ <input type="text" value="240.4"/> MPa |
| | $\sigma =$ <input type="text" value="5.3"/> MPa < $f_t s =$ <input type="text" value="240.4"/> MPa |
| (8) The construction way of the anchor bolt | |
| 1.The construction way of the anchor bolt | = <input type="text" value="Boxed J type anchor"/> |
| 2.The thickness of the concrete | = <input type="text" value="120"/> mm= <input type="text" value="0.120"/> m |
| 3.The length of buried part of bolt | = <input type="text" value="70"/> mm= <input type="text" value="0.070"/> m |
| 4.The permissible withdrawal weight | Ta= <input type="text" value="3136"/> N > Rb= <input type="text" value="417"/> N |

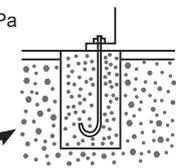

Since the results from the examination above, the anchor bolt has enough strength.

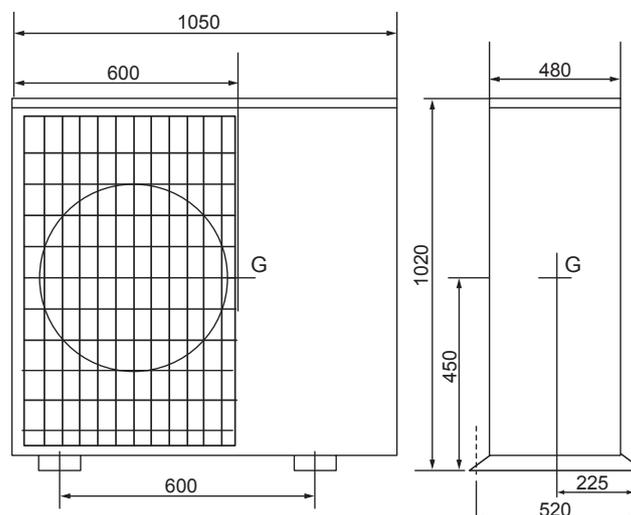

1.Type:

2.Model name:

3.Specification

- | | |
|---|---|
| (1) Unit mass | W= <input type="text" value="134"/> kg |
| (2) Anchor bolt | |
| 1.The total number of bolts | N= <input type="text" value="4"/> |
| 2.The size and shape | "=M <input type="text" value="10"/> type |
| 3.The axis section area per one bolt. | A= <input type="text" value="78"/> mm ² = <input type="text" value="78"/> ×10 ⁻⁶ m ² |
| 4.The total number of bolts in one side which be pulled stronger when the unit inverted | Nt= <input type="text" value="2"/> |
| (3) The height between the installing surface and the center of gravity of the unit | Hg= <input type="text" value="590"/> mm= <input type="text" value="0.590"/> m |
| (4) The bolt-span from the examination angle | L= <input type="text" value="370"/> mm= <input type="text" value="0.370"/> m |
| (5) The distance between the center of bolt and the center of gravity of the unit | Lg= <input type="text" value="180"/> mm(Lg ≤ L/2)= <input type="text" value="0.180"/> m |

4.The examination calculation (by rounding off to the first decimal place of each item)

- | | |
|---|--|
| (1) The horizontal seismic coefficient for designing | Kh= <input type="text" value="1.0"/> |
| (2) The vertical seismic coefficient for designing | Kv=Kh/2= <input type="text" value="0.5"/> |
| (3) The horizontal earthquake forces for designing | Fh=Kh·W·9.8= <input type="text" value="1313.2"/> N |
| (4) The vertical earthquake forces for designing | Fv=Kv·W·9.8= <input type="text" value="656.6"/> N |
| (5) The withdrawal strength of the anchor bolt | $R_b = \frac{F_h \cdot H_g - (W \cdot 9.8 - F_v) \cdot L_g}{L \cdot N_t}$ = <input type="text" value="887.3"/> N |
| (6) The shear forces of the anchor bolt | Q=Fh/N= <input type="text" value="328.3"/> N |
| (7) The stress arising to the anchor bolt | |
| 1.The tensile stress | $\sigma = R_b/A =$ <input type="text" value="11.4"/> MPa < ft=176.4MPa |
| 2.The shearing stress | $\tau = Q/A =$ <input type="text" value="4.2"/> Pa < fs=132.3MPa |
| 3.The stress when affected by both the shearing and the tensile at the same time. | fts=1.4ft-1.6τ= <input type="text" value="240.2"/> MPa |
| | $\sigma =$ <input type="text" value="11.4"/> MPa < fts= <input type="text" value="176.2"/> MPa |
| (8) The construction way of the anchor bolt | |
| 1.The construction way of the anchor bolt | = <input type="text" value="Boxed J type anchor"/> |
| 2.The thickness of the concrete | = <input type="text" value="120"/> mm= <input type="text" value="0.120"/> m |
| 3.The length of buried part of bolt | = <input type="text" value="70"/> mm= <input type="text" value="0.070"/> m |
| 4.The permissible withdrawal weight | Ta= <input type="text" value="3136"/> N > Rb= <input type="text" value="887.3"/> N |

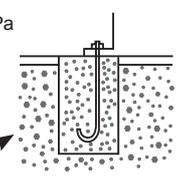

Since the results from the examination above, the anchor bolt has enough strength.

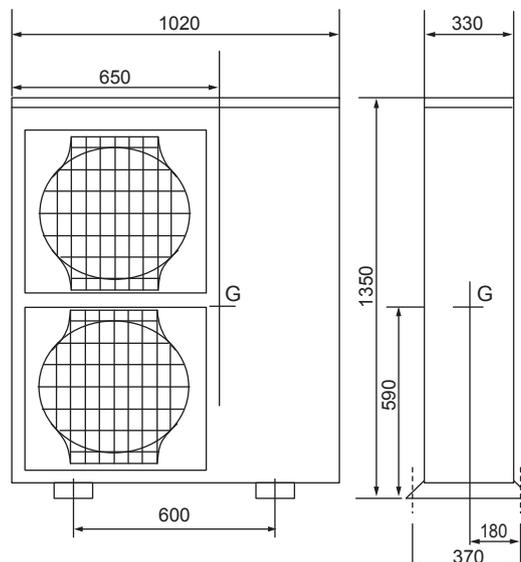

1.Type:

2.Model name:

3.Specification

- | | |
|---|--|
| (1) Unit mass | W= <input type="text" value="148"/> kg |
| (2) Anchor bolt | |
| 1.The total number of bolts | N= <input type="text" value="4"/> |
| 2.The size and shape | "=M <input type="text" value="10"/> type |
| 3.The axis section area per one bolt | A= <input type="text" value="78"/> mm ² = <input type="text" value="78"/> × 10 ⁻⁶ m ² |
| 4.The total number of bolts in one side which be pulled stronger when the unit inverted | Nt= <input type="text" value="2"/> |
| (3) The height between the installing surface and the center of gravity of the unit | Hg= <input type="text" value="590"/> mm= <input type="text" value="0.590"/> m |
| (4) The bolt-span from the examination angle | L= <input type="text" value="370"/> mm= <input type="text" value="0.370"/> m |
| (5) The distance between the center of bolt and the center of gravity of the unit | Lg= <input type="text" value="180"/> mm(Lg ≤ L/2)= <input type="text" value="0.180"/> m |

4.The examination calculation (by rounding off to the first decimal place of each item)

- | | |
|--|---|
| (1) The horizontal seismic coefficient for designing | Kh= <input type="text" value="1.0"/> |
| (2) The vertical seismic coefficient for designing | Kv=Kh/2= <input type="text" value="0.5"/> |
| (3) The horizontal earthquake forces for designing | Fh=Kh·W·9.8= <input type="text" value="1450.4"/> N |
| (4) The vertical earthquake forces for designing | Fv=Kv·W·9.8= <input type="text" value="725.2"/> N |
| (5) The withdrawal strength of the anchor bolt | $R_b = \frac{F_h \cdot H_g - (W \cdot 9.8 - F_v) \cdot L_g}{L \cdot N_t}$ = <input type="text" value="980.0"/> N |
| (6) The shear forces of the anchor bolt | Q=Fh/N= <input type="text" value="362.6"/> N |
| (7) The stress arising to the anchor bolt | |
| 1.The tensile stress | $\sigma = R_b / A =$ <input type="text" value="12.6"/> MPa < ft=176.4MPa |
| 2.The shearing stress | $\tau = Q / A =$ <input type="text" value="4.6"/> MPa < fs=132.3MPa |
| 3.The stress when affected by both the shearing and the tensile at the same time | $f_{ts} = 1.4\sigma + 1.6\tau =$ <input type="text" value="239.5"/> MPa
$\sigma =$ <input type="text" value="12.6"/> MPa < fts= <input type="text" value="176.4"/> MPa |
| (8) The construction way of the anchor bolt | |
| 1.The construction way of the anchor bolt | = <input type="text" value="Boxed J type anchor"/> |
| 2.The thickness of the concrete | = <input type="text" value="120"/> mm= <input type="text" value="0.120"/> m |
| 3.The length of buried part of bolt | = <input type="text" value="70"/> mm= <input type="text" value="0.070"/> m |
| 4.The permissible withdrawal weight | Ta= <input type="text" value="3136"/> N > Rb= <input type="text" value="980"/> N |

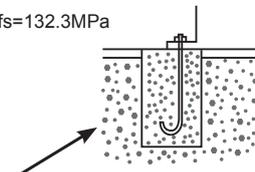

Since the results from the examination above, the anchor bolt has enough strength.

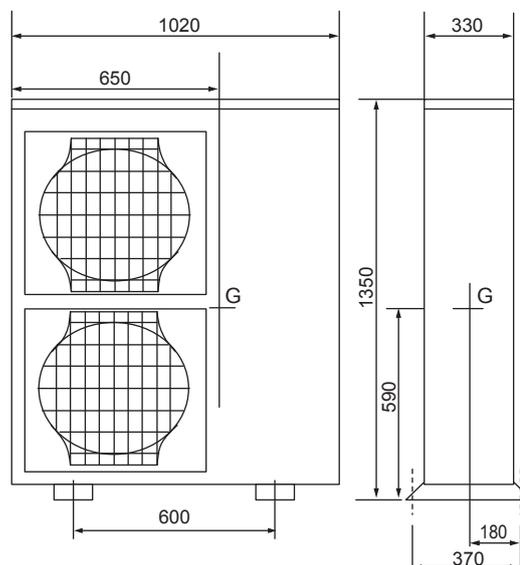

1.Type:

2.Model name:

3.Specification

- | | |
|--|---|
| (1) Unit mass | W= <input type="text" value="57"/> kg |
| (2) Anchor bolt | |
| 1.The total number of bolts. | N= <input type="text" value="4"/> |
| 2.The size and shape. | "=M <input type="text" value="10"/> type |
| 3.The axis section area per one bolt. | A= <input type="text" value="78"/> mm ² = <input type="text" value="78×10<sup>-6"/> "/> m ² |
| 4.The total number of bolts in one side which be pulled stronger when the unit inverted. | Nt= <input type="text" value="2"/> |
| (3) The height between the installing surface and the center of gravity of the unit | Hg= <input type="text" value="340"/> mm= <input type="text" value="0.340"/> m |
| (4) The bolt-span from the examination angle | L= <input type="text" value="360"/> mm= <input type="text" value="0.360"/> m |
| (5) The distance between the center of bolt and the center of gravity of the unit | Lg= <input type="text" value="165"/> mm(Lg≤L/2)= <input type="text" value="0.165"/> m |

4.The examination calculation (by rounding off to the first decimal place of each item)

- | | |
|---|--|
| (1) The horizontal seismic coefficient for designing | Kh= <input type="text" value="1.0"/> |
| (2) The vertical seismic coefficient for designing | Kv=Kh/2= <input type="text" value="0.5"/> |
| (3) The horizontal earthquake forces for designing | Fh=Kh·W·9.8= <input type="text" value="558.6"/> N |
| (4) The vertical earthquake forces for designing | Fv=Kv·W·9.8= <input type="text" value="279.3"/> N |
| (5) The withdrawal strength of the anchor bolt | $R_b = \frac{F_h \cdot H_g - (W \cdot 9.8 - F_v) \cdot L_g}{L \cdot N_t}$ = <input type="text" value="199.8"/> N |
| (6) The shear forces of the anchor bolt | Q=Fh/N= <input type="text" value="139.7"/> N |
| (7) The stress arising to the anchor bolt | |
| 1.The tensile stress. | $\sigma = R_b/A =$ <input type="text" value="2.6"/> MPa < ft = 176.4 MPa |
| 2.The shearing stress. | $\tau = Q/A =$ <input type="text" value="1.8"/> MPa < fs = 132.3 MPa |
| 3.The stress when affected by both the shearing and the tensile at the same time. fts=1.4ft-1.6 τ = | <input type="text" value="244.1"/> MPa |
| | $\sigma =$ <input type="text" value="2.6"/> MPa < fts= <input type="text" value="244.1"/> MPa |
| (8) The construction way of the anchor bolt | |
| 1.The construction way of the anchor bolt. | = <input type="text" value="Boxed J type anchor"/> |
| 2.The thickness of the concrete. | = <input type="text" value="120"/> mm = <input type="text" value="0.120"/> m |
| 3.The length of buried part of bolt. | = <input type="text" value="70"/> mm = <input type="text" value="0.070"/> m |
| 4.The permissible withdrawal weight. | Ta= <input type="text" value="3136"/> N > Rb= <input type="text" value="200"/> N |

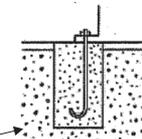

Since the results from the examination above, the anchor bolt has enough strength

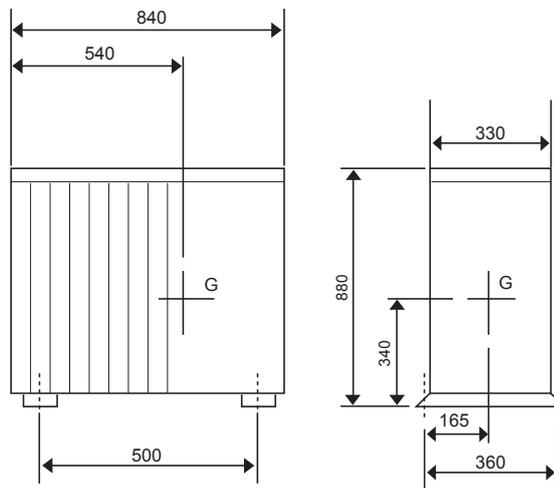

1.Type:

2.Model name:

3.Specification

- | | |
|---|---|
| (1) Unit mass | W= <input type="text" value="43"/> kg |
| (2) Anchor bolt | |
| 1.The total number of bolts | N= <input type="text" value="4"/> |
| 2.The size and shape | "=M <input type="text" value="10"/> type |
| 3.The axis section area per one bolt | A= <input type="text" value="78"/> mm ² = <input type="text" value="78 × 10<sup>-6"/> "/> m ² |
| 4.The total number of bolts in one side which be pulled stronger when the unit inverted | Nt= <input type="text" value="2"/> |
| (3) The height between the installing surface and the center of gravity of the unit | Hg= <input type="text" value="290"/> mm= <input type="text" value="0.290"/> m |
| (4) The bolt-span from the examination angle | L= <input type="text" value="330"/> mm= <input type="text" value="0.330"/> m |
| (5) The distance between the center of bolt and the center of gravity of the unit | Lg= <input type="text" value="165"/> mm(Lg ≤ L/2)= <input type="text" value="0.165"/> m |

4.The examination calculation (by rounding off to the first decimal place of each item)

- | | |
|--|---|
| (1) The horizontal seismic coefficient for designing | Kh= <input type="text" value="1.0"/> |
| (2) The vertical seismic coefficient for designing | Kv=Kh/2= <input type="text" value="0.5"/> |
| (3) The horizontal earthquake forces for designing | Fh=Kh·W·9.8= <input type="text" value="421.4"/> N |
| (4) The vertical earthquake forces for designing | Fv=Kv·W·9.8= <input type="text" value="210.7"/> N |
| (5) The withdrawal strength of the anchor bolt | $R_b = \frac{F_h \cdot H_g - (W \cdot 9.8 - F_v) \cdot L_g}{L \cdot N_t}$
= <input type="text" value="132.5"/> N |
| (6) The shear forces of the anchor bolt | Q=Fh/N= <input type="text" value="105.4"/> N |
| (7) The stress arising to the anchor bolt | |
| 1.The tensile stress | $\sigma = R_b/A =$ <input type="text" value="1.7"/> MPa < ft=176.4MPa |
| 2.The shearing stress | $\tau = Q/A =$ <input type="text" value="1.4"/> MPa < fs=132.3MPa |
| 3.The stress when affected by both the shearing and the tensile at the same time | $f_{ts} = 1.4f_t - 1.6\tau =$ <input type="text" value="244.9"/> MPa
$\sigma =$ <input type="text" value="1.7"/> MPa < fts= <input type="text" value="244.9"/> MPa |
| (8) The construction way of the anchor bolt | |
| 1.The construction way of the anchor bolt | = <input type="text" value="Boxed J type anchor"/> |
| 2.The thickness of the concrete | = <input type="text" value="120"/> mm= <input type="text" value="0.120"/> m |
| 3.The length of buried part of bolt | = <input type="text" value="70"/> mm= <input type="text" value="0.070"/> m |
| 4.The permissible withdrawal weight | Ta= <input type="text" value="3136"/> N > Rb= <input type="text" value="129"/> N |

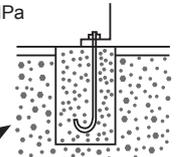

Since the results from the examination above, the anchor bolt has enough strength.

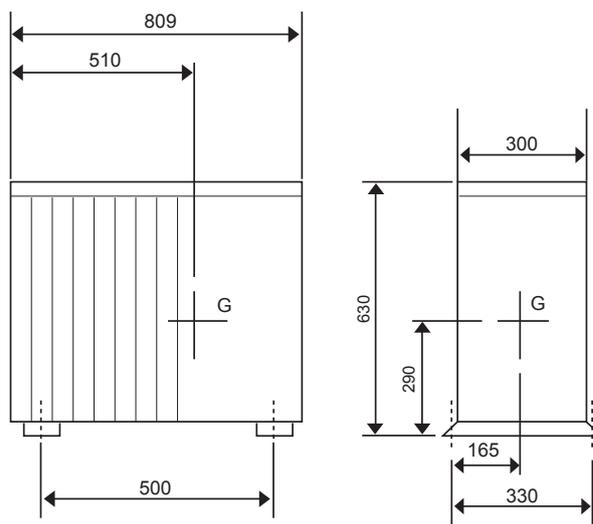

1.Type:

2.Model name:

3.Specification

- | | |
|---|---|
| (1) Unit mass | W= <input type="text" value="75"/> kg |
| (2) Anchor bolt | |
| 1.The total number of bolts | N= <input type="text" value="4"/> |
| 2.The size and shape | "=M <input type="text" value="10"/> type |
| 3.The axis section area per one bolt | A= <input type="text" value="78"/> mm ² = <input type="text" value="78"/> ×10 ⁻⁶ m ² |
| 4.The total number of bolts in one side which be pulled stronger when the unit inverted | Nt= <input type="text" value="2"/> |
| (3) The height between the installing surface and the center of gravity of the unit | Hg= <input type="text" value="403"/> mm= <input type="text" value="0.403"/> m |
| (4) The bolt-span from the examination angle | L= <input type="text" value="370"/> mm= <input type="text" value="0.370"/> m |
| (5) The distance between the center of bolt and the center of gravity of the unit | Lg= <input type="text" value="180"/> mm(Lg≤L/2)= <input type="text" value="0.180"/> m |

4.The examination calculation (by rounding off to the first decimal place of each item)

- | | |
|--|--|
| (1) The horizontal seismic coefficient for designing | Kh= <input type="text" value="1.0"/> |
| (2) The vertical seismic coefficient for designing | Kv=Kh/2= <input type="text" value="0.5"/> |
| (3) The horizontal earthquake forces for designing | Fh=Kh·W·9.8= <input type="text" value="735.0"/> N |
| (4) The vertical earthquake forces for designing | Fv=Kv·W·9.8= <input type="text" value="367.5"/> N |
| (5) The withdrawal strength of the anchor bolt | $R_b = \frac{F_h \cdot H_g - (W \cdot 9.8 - F_v) \cdot L_g}{L \cdot N_t}$ = <input type="text" value="311.0"/> N |
| (6) The shear forces of the anchor bolt | Q=Fh/N= <input type="text" value="183.8"/> N |
| (7) The stress arising to the anchor bolt | |
| 1.The tensile stress | $\sigma = R_b/A =$ <input type="text" value="4.0"/> MPa < ft=176.4MPa |
| 2.The shearing stress | $\tau = Q/A =$ <input type="text" value="2.4"/> MPa < fs=132.3MPa |
| 3.The stress when affected by both the shearing and the tensile at the same time | $f_{ts} = 1.4ft - 1.6\tau =$ <input type="text" value="243.1"/> MPa |
| | $\sigma =$ <input type="text" value="3.6"/> MPa < fts= <input type="text" value="243.1"/> MPa |
| (8) The construction way of the anchor bolt | |
| 1.The construction way of the anchor bolt | = <input type="text" value="Boxed J type anchor"/> |
| 2.The thickness of the concrete | = <input type="text" value="120"/> mm= <input type="text" value="0.120"/> m |
| 3.The length of buried part of bolt | = <input type="text" value="70"/> mm= <input type="text" value="0.070"/> m |
| 4.The permissible withdrawal weight | Ta= <input type="text" value="3136"/> N > Rb= <input type="text" value="311"/> N |

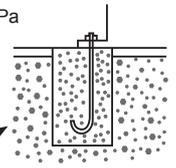

Since the results from the examination above, the anchor bolt has enough strength.

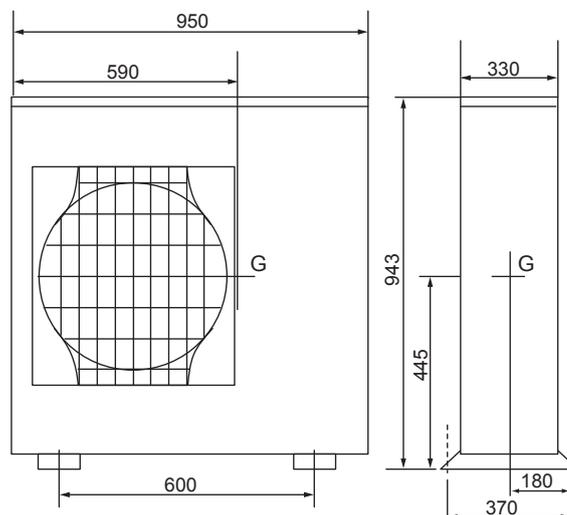

1.Type:

2.Model name:

3.Specification

- | | | | |
|---|-----|----------------------------------|--|
| (1) Unit mass | W= | <input type="text" value="118"/> | kg |
| (2) Anchor bolt | | | |
| 1.The total number of bolts | N= | <input type="text" value="4"/> | |
| 2.The size and shape | "=M | <input type="text" value="10"/> | type |
| 3.The axis section area per one bolt | A= | <input type="text" value="78"/> | mm ² = <input type="text" value="78"/> ×10 ⁻⁶ m ² |
| 4.The total number of bolts in one side which be pulled stronger when the unit inverted | Nt= | <input type="text" value="2"/> | |
| (3) The height between the installing surface and the center of gravity of the unit | Hg= | <input type="text" value="578"/> | mm= <input type="text" value="0.578"/> m |
| (4) The bolt-span from the examination angle | L= | <input type="text" value="370"/> | mm= <input type="text" value="0.370"/> m |
| (5) The distance between the center of bolt and the center of gravity of the unit | Lg= | <input type="text" value="180"/> | mm(Lg ≤ L/2)= <input type="text" value="0.180"/> m |

4.The examination calculation (by rounding off to the first decimal place of each item)

- | | | | | |
|--|---|-------------------------------------|------------------------------------|---|
| (1) The horizontal seismic coefficient for designing | Kh= | <input type="text" value="1.0"/> | | |
| (2) The vertical seismic coefficient for designing | Kv=Kh/2= | <input type="text" value="0.5"/> | | |
| (3) The horizontal earthquake forces for designing | Fh=Kh·W·9.8= | <input type="text" value="1156.4"/> | N | |
| (4) The vertical earthquake forces for designing | Fv=Kv·W·9.8= | <input type="text" value="578.2"/> | N | |
| (5) The withdrawal strength of the anchor bolt | $R_b = \frac{F_h \cdot H_g - (W \cdot 9.8 - F_v) \cdot L_g}{L \cdot N_t}$ | = | <input type="text" value="763.0"/> | N |
| (6) The shear forces of the anchor bolt | Q=Fh/N= | <input type="text" value="289.1"/> | N | |
| (7) The stress arising to the anchor bolt | | | | |
| 1.The tensile stress | $\sigma = R_b/A =$ | <input type="text" value="9.8"/> | MPa < ft=176.4MPa | |
| 2.The shearing stress | $\tau = Q/A =$ | <input type="text" value="3.7"/> | MPa < fs=132.3MPa | |
| 3.The stress when affected by both the shearing and the tensile at the same time | $f_{ts} = 1.4\tau - 1.6\sigma =$ | <input type="text" value="241.0"/> | MPa | |
| | $\sigma =$ | <input type="text" value="9.8"/> | MPa | |
| | < fts= | <input type="text" value="241.0"/> | MPa | |

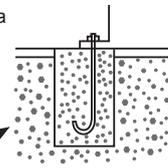

- | | | | |
|---|-----|--|--|
| (8) The construction way of the anchor bolt | | | |
| 1.The construction way of the anchor bolt | = | <input type="text" value="Boxed J type anchor"/> | |
| 2.The thickness of the concrete | = | <input type="text" value="120"/> | mm= <input type="text" value="0.120"/> m |
| 3.The length of buried part of bolt | = | <input type="text" value="70"/> | mm= <input type="text" value="0.070"/> m |
| 4.The permissible withdrawal weight | Ta= | <input type="text" value="3136"/> | N > Rb= <input type="text" value="776"/> N |

Since the results from the examination above, the anchor bolt has enough strength.

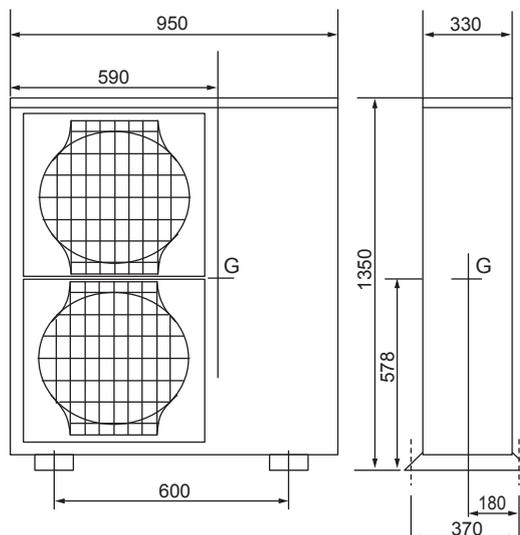

1.Type:

2.Model name:

3.Specification

- | | |
|---|---|
| (1) Unit mass | W= <input type="text" value="130"/> kg |
| (2) Anchor bolt | |
| 1.The total number of bolts | N= <input type="text" value="4"/> |
| 2.The size and shape | "=M <input type="text" value="10"/> type |
| 3.The axis section area per one bolt | A= <input type="text" value="78"/> mm ² = <input type="text" value="78"/> ×10 ⁻⁶ m ² |
| 4.The total number of bolts in one side which be pulled stronger when the unit inverted | Nt= <input type="text" value="2"/> |
| (3) The height between the installing surface and the center of gravity of the unit | Hg= <input type="text" value="578"/> mm= <input type="text" value="0.578"/> m |
| (4) The bolt-span from the examination angle | L= <input type="text" value="370"/> mm= <input type="text" value="0.370"/> m |
| (5) The distance between the center of bolt and the center of gravity of the unit | Lg= <input type="text" value="180"/> mm(Lg≤L/2)= <input type="text" value="0.180"/> m |

4.The examination calculation (by rounding off to the first decimal place of each item)

- | | |
|--|--|
| (1) The horizontal seismic coefficient for designing | Kh= <input type="text" value="1.0"/> |
| (2) The vertical seismic coefficient for designing | Kv=Kh/2= <input type="text" value="0.5"/> |
| (3) The horizontal earthquake forces for designing | Fh=Kh·W·9.8= <input type="text" value="1274.0"/> N |
| (4) The vertical earthquake forces for designing | Fv=Kv·W·9.8= <input type="text" value="637.0"/> N |
| (5) The withdrawal strength of the anchor bolt | $R_b = \frac{F_h \cdot H_g - (W \cdot 9.8 - F_v) \cdot L_g}{L \cdot N_t}$ = <input type="text" value="840.0"/> N |
| (6) The shear forces of the anchor bolt | Q=Fh/N= <input type="text" value="318.5"/> N |
| (7) The stress arising to the anchor bolt | |

- | | |
|--|--|
| 1.The tensile stress | $\sigma = R_b/A =$ <input type="text" value="10.8"/> MPa < ft=176.4MPa |
| 2.The shearing stress | $\tau = Q/A =$ <input type="text" value="4.1"/> MPa < fs=132.3MPa |
| 3.The stress when affected by both the shearing and the tensile at the same time | $f_{ts} = 1.4f_t - 1.6\tau =$ <input type="text" value="240.4"/> MPa |
| | $\sigma =$ <input type="text" value="10.8"/> MPa < $f_{ts} =$ <input type="text" value="240.4"/> MPa |

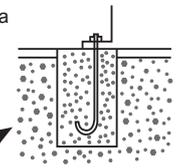

- | | |
|---|--|
| (8) The construction way of the anchor bolt | |
| 1.The construction way of the anchor bolt | = <input type="text" value="Boxed J type anchor"/> |
| 2.The thickness of the concrete | = <input type="text" value="120"/> mm= <input type="text" value="0.120"/> m |
| 3.The length of buried part of bolt | = <input type="text" value="70"/> mm= <input type="text" value="0.070"/> m |
| 4.The permissible withdrawal weight | Ta= <input type="text" value="3136"/> N > Rb= <input type="text" value="776"/> N |

Since the results from the examination above, the anchor bolt has enough strength.

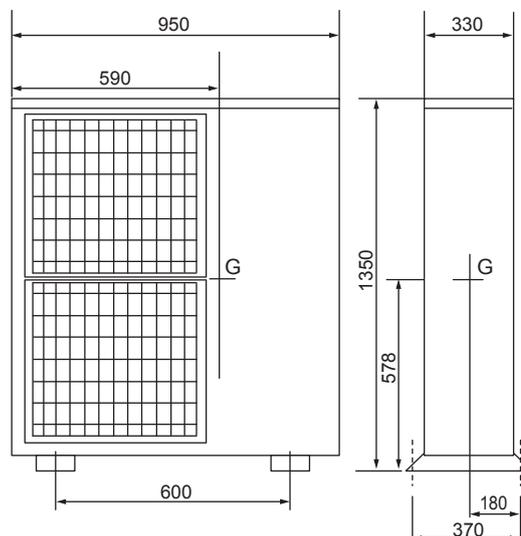

1.Type:

2.Model name:

3.Specification

- | | |
|---|---|
| (1) Unit mass | W= <input type="text" value="136"/> kg |
| (2) Anchor bolt | |
| 1.The total number of bolts | N= <input type="text" value="4"/> |
| 2.The size and shape | "=M <input type="text" value="10"/> type |
| 3.The axis section area per one bolt | A= <input type="text" value="78"/> mm ² = <input type="text" value="78 × 10<sup>-6"/> "/> m ² |
| 4.The total number of bolts in one side which be pulled stronger when the unit inverted | Nt= <input type="text" value="2"/> |
| (3) The height between the installing surface and the center of gravity of the unit | Hg= <input type="text" value="555"/> mm= <input type="text" value="0.555"/> m |
| (4) The bolt-span from the examination angle | L= <input type="text" value="370"/> mm= <input type="text" value="0.370"/> m |
| (5) The distance between the center of bolt and the center of gravity of the unit | Lg= <input type="text" value="180"/> mm(Lg ≤ L/2)= <input type="text" value="0.180"/> m |

4.The examination calculation (by rounding off to the first decimal place of each item)

- | | |
|--|--|
| (1) The horizontal seismic coefficient for designing | Kh= <input type="text" value="1.0"/> |
| (2) The vertical seismic coefficient for designing | Kv=Kh/2= <input type="text" value="0.5"/> |
| (3) The horizontal earthquake forces for designing | Fh=Kh·W·9.8= <input type="text" value="1332.8"/> N |
| (4) The vertical earthquake forces for designing | Fv=Kv·W·9.8= <input type="text" value="666.4"/> N |
| (5) The withdrawal strength of the anchor bolt | $R_b = \frac{F_h \cdot H_g \cdot (W \cdot 9.8 - F_v) \cdot L_g}{L \cdot N_t}$ = <input type="text" value="837.5"/> N |
| (6) The shear forces of the anchor bolt | Q=Fh/N= <input type="text" value="333.2"/> N |
| (7) The stress arising to the anchor bolt | |
| 1.The tensile stress | $\sigma = R_b/A =$ <input type="text" value="10.7"/> MPa < ft=176.4MPa |
| 2.The shearing stress | $\tau = Q/A =$ <input type="text" value="4.3"/> MPa < fs=132.3MPa |
| 3.The stress when affected by both the shearing and the tensile at the same time | $f_{ts} = 1.4f_t - 1.6\tau$ = <input type="text" value="240.1"/> MPa |
| | $\sigma =$ <input type="text" value="10.7"/> MPa < $f_{ts} =$ <input type="text" value="176.4"/> MPa |
| (8) The construction way of the anchor bolt | |
| 1.The construction way of the anchor bolt | = <input type="text" value="Boxed J type anchor"/> |
| 2.The thickness of the concrete | = <input type="text" value="120"/> mm= <input type="text" value="0.120"/> m |
| 3.The length of buried part of bolt | = <input type="text" value="70"/> mm= <input type="text" value="0.070"/> m |
| 4.The permissible withdrawal weight | Ta= <input type="text" value="3136"/> N > Rb= <input type="text" value="837.5"/> N |

Since the results from the examination above, the anchor bolt has enough strength.

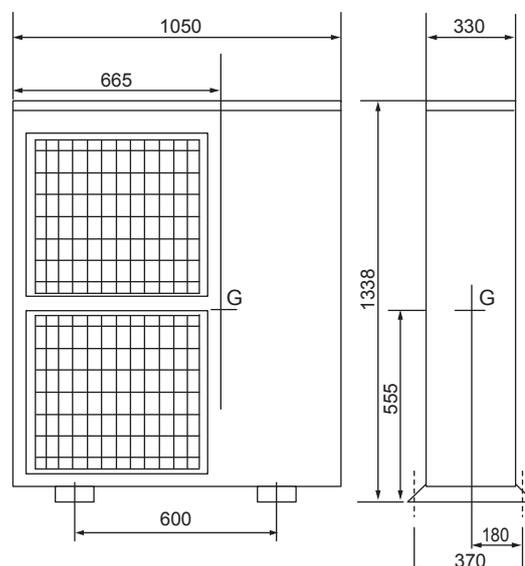

1.Type:

2.Model name:

3.Specification

- | | |
|---|---|
| (1) Unit mass | W= <input type="text" value="92"/> kg |
| (2) Anchor bolt | |
| 1.The total number of bolts | N= <input type="text" value="4"/> |
| 2.The size and shape | "=M <input type="text" value="10"/> type |
| 3.The axis section area per one bolt | A= <input type="text" value="78"/> mm ² = <input type="text" value="78 × 10<sup>-6"/> "/> m ² |
| 4.The total number of bolts in one side which be pulled stronger when the unit inverted | Nt= <input type="text" value="2"/> |
| (3) The height between the installing surface and the center of gravity of the unit | Hg= <input type="text" value="450"/> mm = <input type="text" value="0.45"/> m |
| (4) The bolt-span from the examination angle | L= <input type="text" value="520"/> mm = <input type="text" value="0.52"/> m |
| (5) The distance between the center of bolt and the center of gravity of the unit | Lg= <input type="text" value="225"/> mm (Lg ≤ L/2)= <input type="text" value="0.225"/> m |

4.The examination calculation (by rounding off to the first decimal place of each item)

- | | |
|--|--|
| (1) The horizontal seismic coefficient for designing | Kh= <input type="text" value="1.0"/> |
| (2) The vertical seismic coefficient for designing | Kv=Kh/2= <input type="text" value="0.5"/> |
| (3) The horizontal earthquake forces for designing | Fh=Kh·W·9.8= <input type="text" value="901.6"/> N |
| (4) The vertical earthquake forces for designing | Fv=Kv·W·9.8= <input type="text" value="450.8"/> N |
| (5) The withdrawal strength of the anchor bolt | $R_b = \frac{F_h \cdot H_g - (W \cdot 9.8 - F_v) \cdot L_g}{L \cdot N_t}$ = <input type="text" value="292.6"/> N |
| (6) The shear forces of the anchor bolt | Q=Fh/N= <input type="text" value="225.4"/> N |
| (7) The stress arising to the anchor bolt | |

- | | |
|--|---|
| 1.The tensile stress | $\sigma = R_b/A =$ <input type="text" value="3.8"/> MPa < ft=176.4MPa |
| 2.The shearing stress | $\tau = Q/A =$ <input type="text" value="2.9"/> MPa < fs=132.3MPa |
| 3.The stress when affected by both the shearing and the tensile at the same time | $f_{ts} = 1.4\tau - 1.6\sigma =$ <input type="text" value="242.3"/> MPa |
| | $\sigma =$ <input type="text" value="3.8"/> MPa < fts= <input type="text" value="176.4"/> MPa |

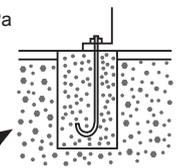

- | | |
|---|--|
| (8) The construction way of the anchor bolt | = <input type="text" value="Boxed J type anchor"/> |
| 1.The construction way of the anchor bolt | |
| 2.The thickness of the concrete | = <input type="text" value="120"/> mm = <input type="text" value="0.120"/> m |
| 3.The length of buried part of bolt | = <input type="text" value="70"/> mm = <input type="text" value="0.070"/> m |
| 4.The permissible withdrawal weight | Ta= <input type="text" value="3136"/> N > Rb= <input type="text" value="292.6"/> N |

Since the results from the examination above, the anchor bolt has enough strength.

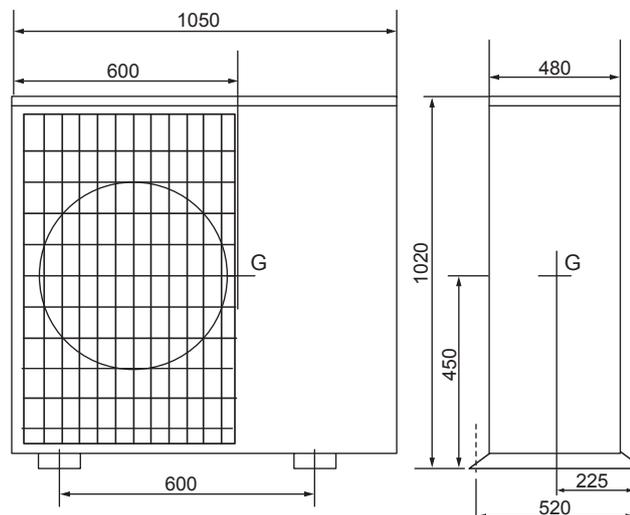

1.Type:

2.Model name:

3.Specification

- | | |
|---|---|
| (1) Unit mass | W= <input type="text" value="104"/> kg |
| (2) Anchor bolt | |
| 1.The total number of bolts | N= <input type="text" value="4"/> |
| 2.The size and shape | "=M <input type="text" value="10"/> type |
| 3.The axis section area per one bolt | A= <input type="text" value="78"/> mm ² = <input type="text" value="78"/> ×10 ⁻⁶ m ² |
| 4.The total number of bolts in one side which be pulled stronger when the unit inverted | Nt= <input type="text" value="2"/> |
| (3) The height between the installing surface and the center of gravity of the unit | Hg= <input type="text" value="480"/> mm= <input type="text" value="0.48"/> m |
| (4) The bolt-span from the examination angle | L= <input type="text" value="520"/> mm= <input type="text" value="0.52"/> m |
| (5) The distance between the center of bolt and the center of gravity of the unit | Lg= <input type="text" value="205"/> mm(Lg≤L/2)= <input type="text" value="0.205"/> m |

4.The examination calculation (by rounding off to the first decimal place of each item)

- | | |
|--|--|
| (1) The horizontal seismic coefficient for designing | Kh= <input type="text" value="1.0"/> |
| (2) The vertical seismic coefficient for designing | Kv=Kh/2= <input type="text" value="0.5"/> |
| (3) The horizontal earthquake forces for designing | Fh=Kh·W·9.8= <input type="text" value="1019.2"/> N |
| (4) The vertical earthquake forces for designing | Fv=Kv·W·9.8= <input type="text" value="509.6"/> N |
| (5) The withdrawal strength of the anchor bolt | $R_b = \frac{F_h \cdot H_g - (W \cdot 9.8 - F_v) \cdot L_g}{L \cdot N_t}$ = <input type="text" value="370.0"/> N |
| (6) The shear forces of the anchor bolt | Q=Fh/N= <input type="text" value="254.8"/> N |
| (7) The stress arising to the anchor bolt | |
| 1.The tensile stress | $\sigma = R_b / A =$ <input type="text" value="4.7"/> MPa < ft=176.4MPa |
| 2.The shearing stress | $\tau = Q / A =$ <input type="text" value="3.3"/> MPa < fs=132.3MPa |
| 3.The stress when affected by both the shearing and the tensile at the same time | $f_t s = 1.4 f_t - 1.6 \tau =$ <input type="text" value="241.7"/> MPa |
| | $\sigma =$ <input type="text" value="4.7"/> MPa < $f_t s =$ <input type="text" value="176.4"/> MPa |
| (8) The construction way of the anchor bolt | |
| 1.The construction way of the anchor bolt | = <input type="text" value="Boxed J type anchor"/> |
| 2.The thickness of the concrete | = <input type="text" value="120"/> mm= <input type="text" value="0.120"/> m |
| 3.The length of buried part of bolt | = <input type="text" value="70"/> mm= <input type="text" value="0.070"/> m |
| 4.The permissible withdrawal weight | Ta= <input type="text" value="3136"/> N > Rb= <input type="text" value="370.0"/> N |

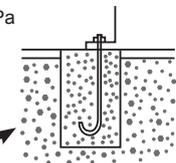

Since the results from the examination above, the anchor bolt has enough strength.

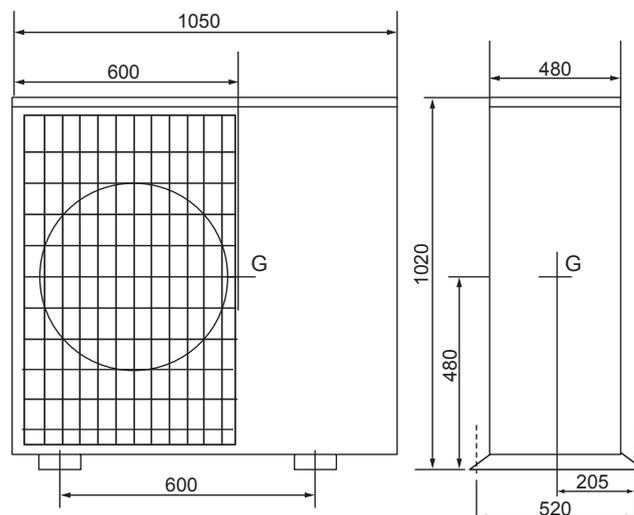

1.Type:

2.Model name:

3.Specification

- | | | | |
|---|-----|----------------------------------|---|
| (1) Unit mass | W= | <input type="text" value="114"/> | kg |
| (2) Anchor bolt | | | |
| 1.The total number of bolts | N= | <input type="text" value="4"/> | |
| 2.The size and shape | "=M | <input type="text" value="10"/> | type |
| 3.The axis section area per one bolt | A= | <input type="text" value="78"/> | mm ² = <input type="text" value="78"/> × 10 ⁻⁶ m ² |
| 4.The total number of bolts in one side which be pulled stronger when the unit inverted | Nt= | <input type="text" value="2"/> | |
| (3) The height between the installing surface and the center of gravity of the unit | Hg= | <input type="text" value="435"/> | mm = <input type="text" value="0.435"/> m |
| (4) The bolt-span from the examination angle | L= | <input type="text" value="520"/> | mm = <input type="text" value="0.52"/> m |
| (5) The distance between the center of bolt and the center of gravity of the unit | Lg= | <input type="text" value="245"/> | mm(Lg ≤ L/2)= <input type="text" value="0.245"/> m |

4.The examination calculation (by rounding off to the first decimal place of each item)

- | | | |
|--|---|--|
| (1) The horizontal seismic coefficient for designing | Kh= | <input type="text" value="1.0"/> |
| (2) The vertical seismic coefficient for designing | Kv=Kh/2= | <input type="text" value="0.5"/> |
| (3) The horizontal earthquake forces for designing | Fh=Kh·W·9.8= | <input type="text" value="1117.2"/> N |
| (4) The vertical earthquake forces for designing | Fv=Kv·W·9.8= | <input type="text" value="558.6"/> N |
| (5) The withdrawal strength of the anchor bolt | $R_b = \frac{F_h \cdot H_g - (W \cdot 9.8 - F_v) \cdot L_g}{L \cdot N_t}$ | = <input type="text" value="335.7"/> N |
| (6) The shear forces of the anchor bolt | Q=Fh/N= | <input type="text" value="279.3"/> N |

(7) The stress arising to the anchor bolt

- | | | |
|--|-----------------------------|---|
| 1.The tensile stress | $\sigma = R_b/A =$ | <input type="text" value="4.3"/> MPa < $f_t = 176.4$ MPa |
| 2.The shearing stress | $\tau = Q/A =$ | <input type="text" value="3.6"/> MPa < $f_s = 132.3$ MPa |
| 3.The stress when affected by both the shearing and the tensile at the same time | $f_{ts} = 1.4f_t - 1.6\tau$ | <input type="text" value="241.2"/> MPa |
| | $\sigma =$ | <input type="text" value="4.3"/> MPa < $f_{ts} = 176.4$ MPa |

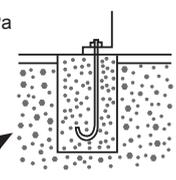

(8) The construction way of the anchor bolt

- | | | |
|---|-----|---|
| 1.The construction way of the anchor bolt | = | <input type="text" value="Boxed J type anchor"/> |
| 2.The thickness of the concrete | = | <input type="text" value="120"/> mm = <input type="text" value="0.120"/> m |
| 3.The length of buried part of bolt | = | <input type="text" value="70"/> mm = <input type="text" value="0.070"/> m |
| 4.The permissible withdrawal weight | Ta= | <input type="text" value="3136"/> N > Rb <input type="text" value="335.7"/> N |

Since the results from the examination above, the anchor bolt has enough strength.

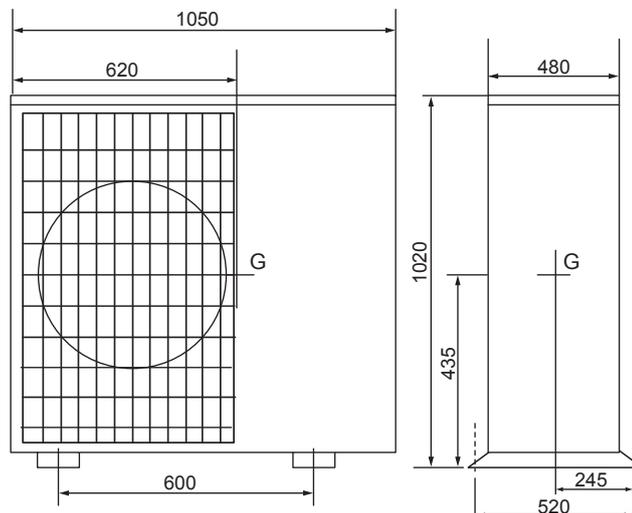

1.Type:

2.Model name:

3.Specification

- | | |
|---|---|
| (1) Unit mass | W= <input type="text" value="126"/> kg |
| (2) Anchor bolt | |
| 1.The total number of bolts | N= <input type="text" value="4"/> |
| 2.The size and shape | "=M <input type="text" value="10"/> type |
| 3.The axis section area per one bolt | A= <input type="text" value="78"/> mm ² = <input type="text" value="78 × 10<sup>-6"/> "/> m ² |
| 4.The total number of bolts in one side which be pulled stronger when the unit inverted | Nt= <input type="text" value="2"/> |
| (3) The height between the installing surface and the center of gravity of the unit | Hg= <input type="text" value="470"/> mm= <input type="text" value="0.47"/> m |
| (4) The bolt-span from the examination angle | L= <input type="text" value="520"/> mm= <input type="text" value="0.52"/> m |
| (5) The distance between the center of bolt and the center of gravity of the unit | Lg= <input type="text" value="215"/> mm(Lg≤L/2)= <input type="text" value="0.215"/> m |

4.The examination calculation (by rounding off to the first decimal place of each item)

- | | |
|--|--|
| (1) The horizontal seismic coefficient for designing | Kh= <input type="text" value="1.0"/> |
| (2) The vertical seismic coefficient for designing | Kv=Kh/2= <input type="text" value="0.5"/> |
| (3) The horizontal earthquake forces for designing | Fh=Kh·W·9.8= <input type="text" value="1234.8"/> N |
| (4) The vertical earthquake forces for designing | Fv=Kv·W·9.8= <input type="text" value="617.4"/> N |
| (5) The withdrawal strength of the anchor bolt | $R_b = \frac{F_h \cdot H_g - (W \cdot 9.8 - F_v) \cdot L_g}{L \cdot N_t}$ = <input type="text" value="430.4"/> N |
| (6) The shear forces of the anchor bolt | Q=Fh/N= <input type="text" value="308.7"/> N |
| (7) The stress arising to the anchor bolt | |
| 1.The tensile stress | $\sigma = R_b / A =$ <input type="text" value="5.5"/> MPa < ft=176.4MPa |
| 2.The shearing stress | $\tau = Q / A =$ <input type="text" value="4.0"/> MPa < fs=132.3MPa |
| 3.The stress when affected by both the shearing and the tensile at the same time | $f_{ts} = 1.4ft - 1.6\tau =$ <input type="text" value="240.6"/> MPa |
| | $\sigma =$ <input type="text" value="5.5"/> MPa < fts= <input type="text" value="176.4"/> MPa |
| (8) The construction way of the anchor bolt | |
| 1.The construction way of the anchor bolt | = <input type="text" value="Boxed J type anchor"/> |
| 2.The thickness of the concrete | = <input type="text" value="120"/> mm= <input type="text" value="0.120"/> m |
| 3.The length of buried part of bolt | = <input type="text" value="70"/> mm= <input type="text" value="0.070"/> m |
| 4.The permissible withdrawal weight | Ta= <input type="text" value="3136"/> N > Rb <input type="text" value="430.4"/> N |

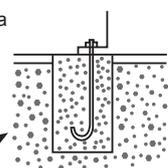

Since the results from the examination above, the anchor bolt has enough strength.

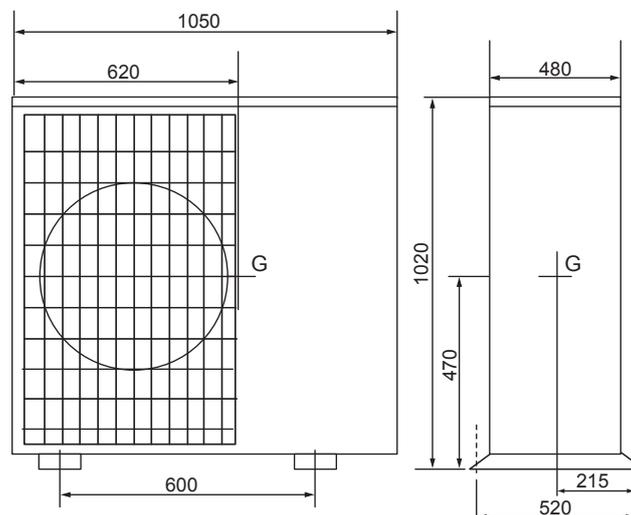

1.Type:

2.Model name:

3.Specification

- | | |
|---|---|
| (1) Unit mass | W= <input type="text" value="73"/> kg |
| (2) Anchor bolt | |
| 1.The total number of bolts | N= <input type="text" value="4"/> |
| 2.The size and shape | "=M <input type="text" value="10"/> type |
| 3.The axis section area per one bolt | A= <input type="text" value="78"/> mm ² = <input type="text" value="78×10<sup>-6"/> "/> m ² |
| 4.The total number of bolts in one side which be pulled stronger when the unit inverted | Nt= <input type="text" value="2"/> |
| (3) The height between the installing surface and the center of gravity of the unit | Hg= <input type="text" value="445"/> mm= <input type="text" value="0.445"/> m |
| (4) The bolt-span from the examination angle | L= <input type="text" value="370"/> mm= <input type="text" value="0.370"/> m |
| (5) The distance between the center of bolt and the center of gravity of the unit | Lg= <input type="text" value="185"/> mm(Lg≤L/2)= <input type="text" value="0.185"/> m |

4.The examination calculation (by rounding off to the first decimal place of each item)

- | | |
|--|--|
| (1) The horizontal seismic coefficient for designing | Kh= <input type="text" value="1.0"/> |
| (2) The vertical seismic coefficient for designing | Kv=Kh/2= <input type="text" value="0.5"/> |
| (3) The horizontal earthquake forces for designing | Fh=Kh·W·9.8= <input type="text" value="715.4"/> N |
| (4) The vertical earthquake forces for designing | Fv=Kv·W·9.8= <input type="text" value="357.7"/> N |
| (5) The withdrawal strength of the anchor bolt | $R_b = \frac{F_h \cdot H_g - (W \cdot 9.8 - F_v) \cdot L_g}{L \cdot N_t}$ = <input type="text" value="340.8"/> N |
| (6) The shear forces of the anchor bolt | Q=Fh/N= <input type="text" value="178.9"/> N |

(7) The stress arising to the anchor bolt

- | | |
|--|---|
| 1.The tensile stress | $\sigma = R_b/A =$ <input type="text" value="4.4"/> MPa < $f_t = 176.4$ MPa |
| 2.The shearing stress | $\tau = Q/A =$ <input type="text" value="2.3"/> MPa < $f_s = 132.3$ MPa |
| 3.The stress when affected by both the shearing and the tensile at the same time | $f_{ts} = 1.4\sigma + 1.6\tau =$ <input type="text" value="242.7"/> MPa |
| | $\sigma =$ <input type="text" value="4.4"/> MPa < $f_{ts} =$ <input type="text" value="242.7"/> MPa |

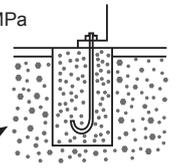

(8) The construction way of the anchor bolt

- | | |
|---|--|
| 1.The construction way of the anchor bolt | = <input type="text" value="Boxed J type anchor"/> |
| 2.The thickness of the concrete | = <input type="text" value="120"/> mm= <input type="text" value="0.120"/> m |
| 3.The length of buried part of bolt | = <input type="text" value="70"/> mm= <input type="text" value="0.070"/> m |
| 4.The permissible withdrawal weight | Ta= <input type="text" value="3136"/> N > Rb= <input type="text" value="340.8"/> N |

Since the results from the examination above, the anchor bolt has enough strength.

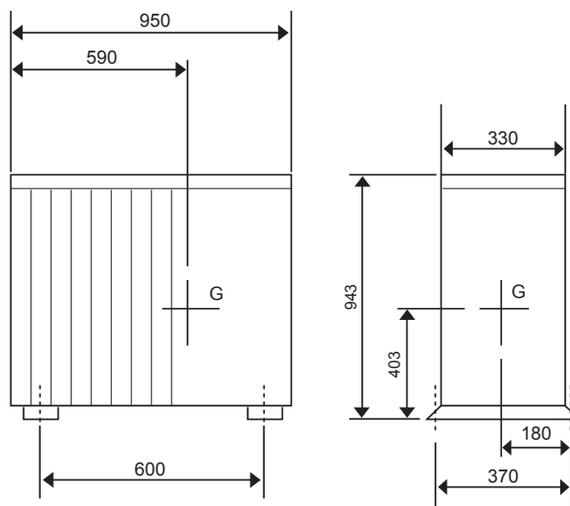

1.Type: ZUBADAN Outdoor unit

2.Model name: PUHZ-SHW80VHA(-BS), PUHZ-SHW112VHA(-BS)

3.Specification

- | | | | |
|---|-----|----------------------------------|---|
| (1) Unit mass | W= | <input type="text" value="120"/> | kg |
| (2) Anchor bolt | | | |
| 1.The total number of bolts | N= | <input type="text" value="4"/> | |
| 2.The size and shape | "=M | <input type="text" value="10"/> | type |
| 3.The axis section area per one bolt | A= | <input type="text" value="78"/> | mm ² = <input type="text" value="78"/> × 10 ⁻⁶ m ² |
| 4.The total number of bolts in one side which be pulled stronger when the unit inverted | Nt= | <input type="text" value="2"/> | |
| (3) The height between the installing surface and the center of gravity of the unit | Hg= | <input type="text" value="578"/> | mm= <input type="text" value="0.578"/> m |
| (4) The bolt-span from the examination angle | L= | <input type="text" value="370"/> | mm= <input type="text" value="0.370"/> m |
| (5) The distance between the center of bolt and the center of gravity of the unit | Lg= | <input type="text" value="180"/> | mm(Lg ≤ L/2)= <input type="text" value="0.180"/> m |

4.The examination calculation (by rounding off to the first decimal place of each item)

- | | | | | |
|--|---|--|--|---|
| (1) The horizontal seismic coefficient for designing | Kh= | <input type="text" value="1.0"/> | | |
| (2) The vertical seismic coefficient for designing | Kv=Kh/2= | <input type="text" value="0.5"/> | | |
| (3) The horizontal earthquake forces for designing | Fh=Kh·W·9.8= | <input type="text" value="1176.0"/> | N | |
| (4) The vertical earthquake forces for designing | Fv=Kv·W·9.8= | <input type="text" value="588.0"/> | N | |
| (5) The withdrawal strength of the anchor bolt | $R_b = \frac{F_h \cdot H_g - (W \cdot 9.8 - F_v) \cdot L_g}{L \cdot N_t}$ | = | <input type="text" value="775.5"/> | N |
| (6) The shear forces of the anchor bolt | Q=Fh/N= | <input type="text" value="294.0"/> | N | |
| (7) The stress arising to the anchor bolt | | | | |
| 1.The tensile stress | $\sigma = R_b / A =$ | <input type="text" value="9.9"/> | MPa < $f_t = 176.4$ MPa | |
| 2.The shearing stress | $\tau = Q / A =$ | <input type="text" value="3.8"/> | MPa < $f_s = 132.3$ MPa | |
| 3.The stress when affected by both the shearing and the tensile at the same time | $f_{ts} = 1.4f_t - 1.6\tau =$ | <input type="text" value="240.9"/> | MPa | |
| | $\sigma =$ | <input type="text" value="9.9"/> | MPa < $f_{ts} =$ | |
| | | | <input type="text" value="240.9"/> | |
| (8) The construction way of the anchor bolt | | | | |
| 1.The construction way of the anchor bolt | = | <input type="text" value="Boxed J type anchor"/> | | |
| 2.The thickness of the concrete | = | <input type="text" value="120"/> | mm= <input type="text" value="0.120"/> m | |
| 3.The length of buried part of bolt | = | <input type="text" value="70"/> | mm= <input type="text" value="0.070"/> m | |
| 4.The permissible withdrawal weight | Ta= | <input type="text" value="3136"/> | N > Rb= <input type="text" value="776"/> | |
| | | | N | |

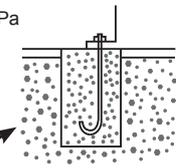

Since the results from the examination above, the anchor bolt has enough strength.

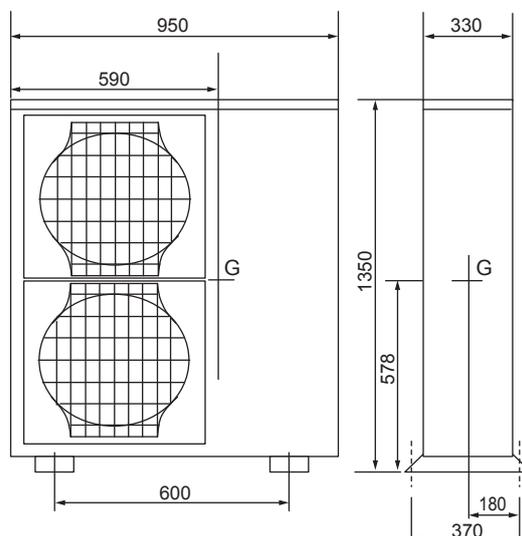

1.Type:

2.Model name:

3.Specification

- | | |
|---|---|
| (1) Unit mass | W= <input type="text" value="134"/> kg |
| (2) Anchor bolt | |
| 1.The total number of bolts | N= <input type="text" value="4"/> |
| 2.The size and shape | "=M <input type="text" value="10"/> type |
| 3.The axis section area per one bolt | A= <input type="text" value="78"/> mm ² = <input type="text" value="78 × 10<sup>-6"/> "/> m ² |
| 4.The total number of bolts in one side which be pulled stronger when the unit inverted | Nt= <input type="text" value="2"/> |
| (3) The height between the installing surface and the center of gravity of the unit | Hg= <input type="text" value="578"/> mm= <input type="text" value="0.578"/> m |
| (4) The bolt-span from the examination angle | L= <input type="text" value="370"/> mm= <input type="text" value="0.370"/> m |
| (5) The distance between the center of bolt and the center of gravity of the unit | Lg= <input type="text" value="180"/> mm(Lg ≤ L/2)= <input type="text" value="0.180"/> m |

4.The examination calculation (by rounding off to the first decimal place of each item)

- | | |
|--|--|
| (1) The horizontal seismic coefficient for designing | Kh= <input type="text" value="1.0"/> |
| (2) The vertical seismic coefficient for designing | Kv=Kh/2= <input type="text" value="0.5"/> |
| (3) The horizontal earthquake forces for designing | Fh=Kh·W·9.8= <input type="text" value="1313.2"/> N |
| (4) The vertical earthquake forces for designing | Fv=Kv·W·9.8= <input type="text" value="656.6"/> N |
| (5) The withdrawal strength of the anchor bolt | $R_b = \frac{F_h \cdot H_g - (W \cdot 9.8 - F_v) \cdot L_g}{L \cdot N_t}$ = <input type="text" value="866.0"/> N |
| (6) The shear forces of the anchor bolt | Q=Fh/N= <input type="text" value="328.3"/> N |
| (7) The stress arising to the anchor bolt | |
| 1.The tensile stress | $\sigma = R_b / A =$ <input type="text" value="11.1"/> MPa < ft=176.4MPa |
| 2.The shearing stress | $\tau = Q / A =$ <input type="text" value="4.2"/> MPa < fs=132.3MPa |
| 3.The stress when affected by both the shearing and the tensile at the same time | $f_{ts} = 1.4\tau - 1.6\sigma =$ <input type="text" value="240.2"/> MPa |
| | $\sigma =$ <input type="text" value="11.1"/> MPa < $f_{ts} =$ <input type="text" value="240.2"/> MPa |

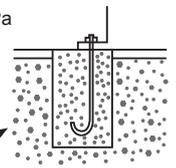

- | | |
|---|--|
| (8) The construction way of the anchor bolt | |
| 1.The construction way of the anchor bolt | = <input type="text" value="Boxed J type anchor"/> |
| 2.The thickness of the concrete | = <input type="text" value="120"/> mm= <input type="text" value="0.120"/> m |
| 3.The length of buried part of bolt | = <input type="text" value="70"/> mm= <input type="text" value="0.070"/> m |
| 4.The permissible withdrawal weight | Ta= <input type="text" value="3136"/> N > Rb= <input type="text" value="866"/> N |

Since the results from the examination above, the anchor bolt has enough strength.

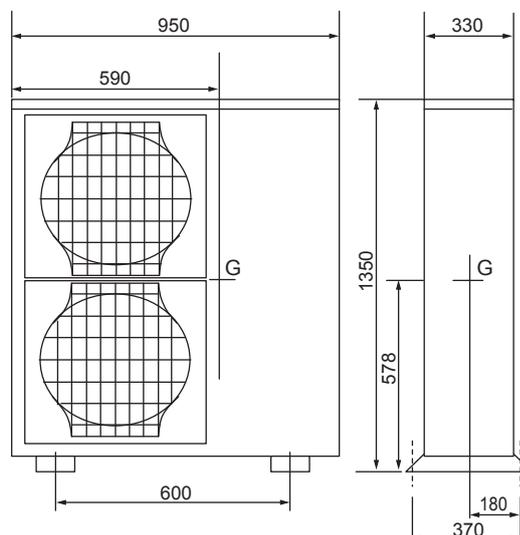

1.Type:

2.Model name:

3.Specification

- | | |
|---|---|
| (1) Unit mass | W= <input type="text" value="149"/> kg |
| (2) Anchor bolt | |
| 1.The total number of bolts | N= <input type="text" value="4"/> |
| 2.The size and shape | "=M <input type="text" value="10"/> type |
| 3.The axis section area per one bolt | A= <input type="text" value="78"/> mm ² = <input type="text" value="78"/> ×10 ⁻⁶ m ² |
| 4.The total number of bolts in one side which be pulled stronger when the unit inverted | Nt= <input type="text" value="2"/> |
| (3) The height between the installing surface and the center of gravity of the unit | Hg= <input type="text" value="590"/> mm= <input type="text" value="0.590"/> m |
| (4) The bolt-span from the examination angle | L= <input type="text" value="370"/> mm= <input type="text" value="0.370"/> m |
| (5) The distance between the center of bolt and the center of gravity of the unit | Lg= <input type="text" value="180"/> mm(Lg≤L/2)= <input type="text" value="0.180"/> m |

4.The examination calculation (by rounding off to the first decimal place of each item)

- | | |
|--|--|
| (1) The horizontal seismic coefficient for designing | Kh= <input type="text" value="1.0"/> |
| (2) The vertical seismic coefficient for designing | Kv=Kh/2= <input type="text" value="0.5"/> |
| (3) The horizontal earthquake forces for designing | Fh=Kh·W·9.8= <input type="text" value="1460.2"/> N |
| (4) The vertical earthquake forces for designing | Fv=Kv·W·9.8= <input type="text" value="730.1"/> N |
| (5) The withdrawal strength of the anchor bolt | $R_b = \frac{F_h \cdot H_g - (W \cdot 9.8 - F_v) \cdot L_g}{L \cdot N_t}$ = <input type="text" value="986.6"/> N |
| (6) The shear forces of the anchor bolt | Q=Fh/N= <input type="text" value="365.1"/> N |
| (7) The stress arising to the anchor bolt | |
| 1.The tensile stress | $\sigma = R_b/A =$ <input type="text" value="12.6"/> MPa < ft=176.4MPa |
| 2.The shearing stress | $\tau = Q/A =$ <input type="text" value="4.7"/> MPa < fs=132.3MPa |
| 3.The stress when affected by both the shearing and the tensile at the same time | $f_{ts} = 1.4\tau + 1.6\sigma =$ <input type="text" value="239.5"/> MPa
< fts= <input type="text" value="176.4"/> MPa |
| (8) The construction way of the anchor bolt | |
| 1.The construction way of the anchor bolt | = <input type="text" value="Boxed J type anchor"/> |
| 2.The thickness of the concrete | = <input type="text" value="120"/> mm= <input type="text" value="0.120"/> m |
| 3.The length of buried part of bolt | = <input type="text" value="70"/> mm= <input type="text" value="0.070"/> m |
| 4.The permissible withdrawal weight | Ta= <input type="text" value="3136"/> N > Rb= <input type="text" value="960.1"/> N |

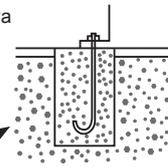

Since the results from the examination above, the anchor bolt has enough strength.

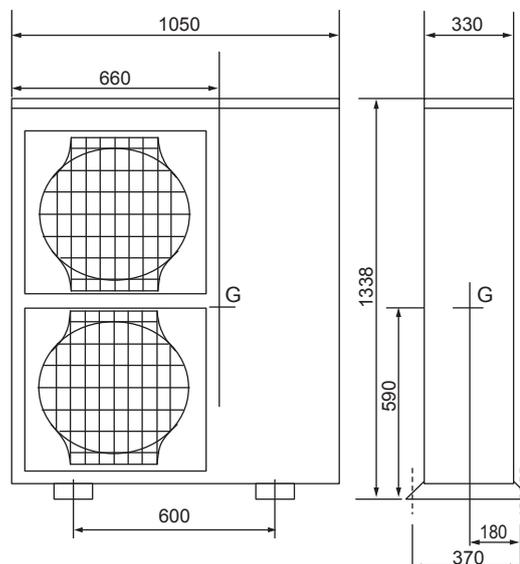

1.Type:

2.Model name:

3.Specification

- | | | | |
|---|-----|----------------------------------|--|
| (1) Unit mass | W= | <input type="text" value="116"/> | kg |
| (2) Anchor bolt | | | |
| 1.The total number of bolts | N= | <input type="text" value="4"/> | |
| 2.The size and shape | "=M | <input type="text" value="10"/> | type |
| 3.The axis section area per one bolt | A= | <input type="text" value="78"/> | mm ² = <input type="text" value="78"/> ×10 ⁻⁶ m ² |
| 4.The total number of bolts in one side which be pulled stronger when the unit inverted | Nt= | <input type="text" value="2"/> | |
| (3) The height between the installing surface and the center of gravity of the unit | Hg= | <input type="text" value="435"/> | mm = <input type="text" value="0.435"/> m |
| (4) The bolt-span from the examination angle | L= | <input type="text" value="520"/> | mm = <input type="text" value="0.52"/> m |
| (5) The distance between the center of bolt and the center of gravity of the unit | Lg= | <input type="text" value="245"/> | mm(Lg≤L/2)= <input type="text" value="0.245"/> m |

4.The examination calculation (by rounding off to the first decimal place of each item)

- | | | | |
|--|---|--|--|
| (1) The horizontal seismic coefficient for designing | Kh= | <input type="text" value="1.0"/> | |
| (2) The vertical seismic coefficient for designing | Kv=Kh/2= | <input type="text" value="0.5"/> | |
| (3) The horizontal earthquake forces for designing | Fh=Kh·W·9.8= | <input type="text" value="1136.8"/> | N |
| (4) The vertical earthquake forces for designing | Fv=Kv·W·9.8= | <input type="text" value="568.4"/> | N |
| (5) The withdrawal strength of the anchor bolt | $R_b = \frac{F_h \cdot H_g - (W \cdot 9.8 - F_v) \cdot L_g}{L \cdot N_t}$ | = | <input type="text" value="341.6"/> N |
| (6) The shear forces of the anchor bolt | Q=Fh/N= | <input type="text" value="284.2"/> | N |
| (7) The stress arising to the anchor bolt | | | |
| 1.The tensile stress | $\sigma = R_b / A =$ | <input type="text" value="4.4"/> MPa | < ft=176.4MPa |
| 2.The shearing stress | $\tau = Q / A =$ | <input type="text" value="3.6"/> MPa | < fs=132.3MPa |
| 3.The stress when affected by both the shearing and the tensile at the same time | $f_{ts} = 1.4f_t - 1.6\tau$ | <input type="text" value="241.1"/> MPa | |
| | $\sigma =$ | <input type="text" value="4.4"/> MPa | < f _{ts} = <input type="text" value="176.4"/> MPa |
| (8) The construction way of the anchor bolt | | | |
| 1.The construction way of the anchor bolt | = | <input type="text" value="Boxed J type anchor"/> | |
| 2.The thickness of the concrete | = | <input type="text" value="120"/> mm = <input type="text" value="0.120"/> m | |
| 3.The length of buried part of bolt | = | <input type="text" value="70"/> mm = <input type="text" value="0.070"/> m | |
| 4.The permissible withdrawal weight | Ta= | <input type="text" value="3136"/> N | > Rb <input type="text" value="341.6"/> N |

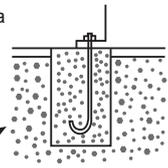

Since the results from the examination above, the anchor bolt has enough strength.

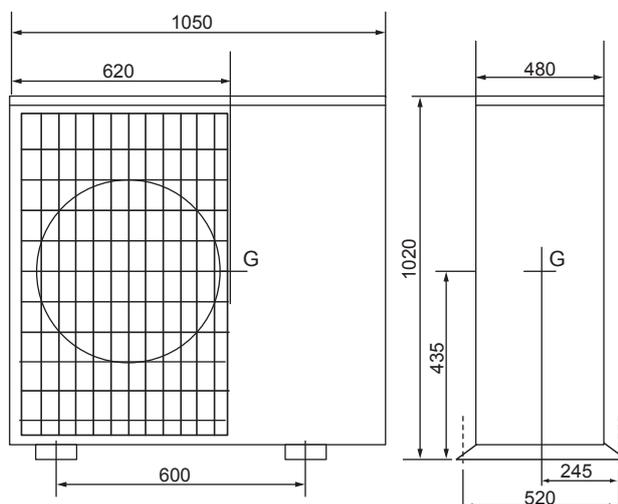

1.Type:

2.Model name:

3.Specification

- | | |
|---|---|
| (1) Unit mass | W= <input type="text" value="128"/> kg |
| (2) Anchor bolt | |
| 1.The total number of bolts | N= <input type="text" value="4"/> |
| 2.The size and shape | "=M <input type="text" value="10"/> type |
| 3.The axis section area per one bolt | A= <input type="text" value="78"/> mm ² = <input type="text" value="78 × 10<sup>-6"/> "/> m ² |
| 4.The total number of bolts in one side which be pulled stronger when the unit inverted | Nt= <input type="text" value="2"/> |
| (3) The height between the installing surface and the center of gravity of the unit | Hg= <input type="text" value="470"/> mm= <input type="text" value="0.47"/> m |
| (4) The bolt-span from the examination angle | L= <input type="text" value="520"/> mm= <input type="text" value="0.52"/> m |
| (5) The distance between the center of bolt and the center of gravity of the unit | Lg= <input type="text" value="215"/> mm(Lg≤L/2)= <input type="text" value="0.215"/> m |

4.The examination calculation (by rounding off to the first decimal place of each item)

- | | |
|--|---|
| (1) The horizontal seismic coefficient for designing | Kh= <input type="text" value="1.0"/> |
| (2) The vertical seismic coefficient for designing | Kv=Kh/2= <input type="text" value="0.5"/> |
| (3) The horizontal earthquake forces for designing | Fh=Kh·W·9.8= <input type="text" value="1254.4"/> N |
| (4) The vertical earthquake forces for designing | Fv=Kv·W·9.8= <input type="text" value="627.2"/> N |
| (5) The withdrawal strength of the anchor bolt | $R_b = \frac{F_h \cdot H_g - (W \cdot 9.8 - F_v) \cdot L_g}{L \cdot N_t}$ = <input type="text" value="437.2"/> N |
| (6) The shear forces of the anchor bolt | Q=Fh/N= <input type="text" value="313.6"/> N |
| (7) The stress arising to the anchor bolt | |
| 1.The tensile stress | $\sigma = R_b / A =$ <input type="text" value="5.6"/> MPa < ft=176.4MPa |
| 2.The shearing stress | $\tau = Q / A =$ <input type="text" value="4.0"/> MPa < fs=132.3MPa |
| 3.The stress when affected by both the shearing and the tensile at the same time | $f_{ts} = 1.4\sigma - 1.6\tau =$ <input type="text" value="240.5"/> MPa < fts= <input type="text" value="176.4"/> MPa |
| | $\sigma =$ <input type="text" value="5.6"/> MPa |
| (8) The construction way of the anchor bolt | |
| 1.The construction way of the anchor bolt | = <input type="text" value="Boxed J type anchor"/> |
| 2.The thickness of the concrete | = <input type="text" value="120"/> mm= <input type="text" value="0.120"/> m |
| 3.The length of buried part of bolt | = <input type="text" value="70"/> mm= <input type="text" value="0.070"/> m |
| 4.The permissible withdrawal weight | Ta= <input type="text" value="3136"/> N > Rb <input type="text" value="437.2"/> N |

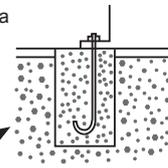

Since the results from the examination above, the anchor bolt has enough strength.

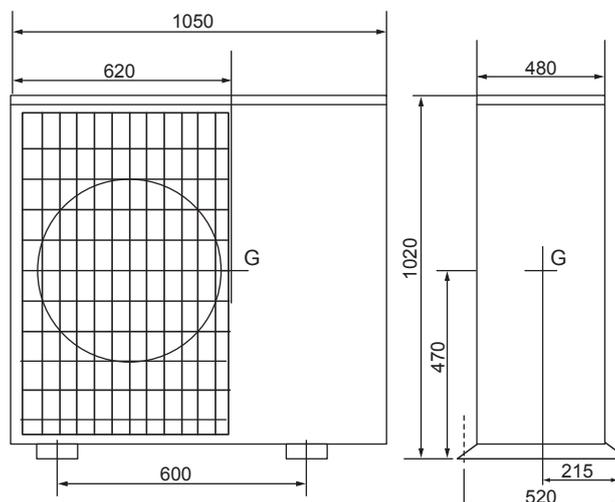

1.Type:

2.Model name:

3.Specification

- | | |
|---|---|
| (1) Unit mass | W= <input type="text" value="122"/> kg |
| (2) Anchor bolt | |
| 1.The total number of bolts | N= <input type="text" value="4"/> |
| 2.The size and shape | "=M <input type="text" value="10"/> type |
| 3.The axis section area per one bolt | A= <input type="text" value="78"/> mm ² = <input type="text" value="78"/> ×10 ⁻⁶ m ² |
| 4.The total number of bolts in one side which be pulled stronger when the unit inverted | Nt= <input type="text" value="2"/> |
| (3) The height between the installing surface and the center of gravity of the unit | Hg= <input type="text" value="507"/> mm= <input type="text" value="0.507"/> m |
| (4) The bolt-span from the examination angle | L= <input type="text" value="370"/> mm= <input type="text" value="0.370"/> m |
| (5) The distance between the center of bolt and the center of gravity of the unit | Lg= <input type="text" value="175"/> mm(Lg≤L/2)= <input type="text" value="0.175"/> m |

4.The examination calculation (by rounding off to the first decimal place of each item)

- | | |
|--|---|
| (1) The horizontal seismic coefficient for designing | Kh= <input type="text" value="1.0"/> |
| (2) The vertical seismic coefficient for designing | Kv=Kh/2= <input type="text" value="0.5"/> |
| (3) The horizontal earthquake forces for designing | Fh=Kh·W·9.8= <input type="text" value="1195.6"/> N |
| (4) The vertical earthquake forces for designing | Fv=Kv·W·9.8= <input type="text" value="597.8"/> N |
| (5) The withdrawal strength of the anchor bolt | $R_b = \frac{F_h \cdot H_g - (W \cdot 9.8 - F_v) \cdot L_g}{L \cdot N_t}$ = <input type="text" value="677.8"/> N |
| (6) The shear forces of the anchor bolt | Q=Fh/N= <input type="text" value="298.9"/> N |
| (7) The stress arising to the anchor bolt | |
| 1.The tensile stress | $\sigma = R_b/A =$ <input type="text" value="8.7"/> MPa < ft=176.4MPa |
| 2.The shearing stress | $\tau = Q/A =$ <input type="text" value="3.8"/> MPa < fs=132.3MPa |
| 3.The stress when affected by both the shearing and the tensile at the same time | $f_{ts} = 1.4\tau + 1.6\sigma =$ <input type="text" value="240.3"/> MPa < fts= <input type="text" value="176.0"/> MPa |
| | $\sigma =$ <input type="text" value="8.7"/> MPa |
| (8) The construction way of the anchor bolt | |
| 1.The construction way of the anchor bolt | = <input type="text" value="Boxed J type anchor"/> |
| 2.The thickness of the concrete | = <input type="text" value="120"/> mm= <input type="text" value="0.120"/> m |
| 3.The length of buried part of bolt | = <input type="text" value="70"/> mm= <input type="text" value="0.070"/> m |
| 4.The permissible withdrawal weight | Ta= <input type="text" value="3136"/> N > Rb= <input type="text" value="677.8"/> N |

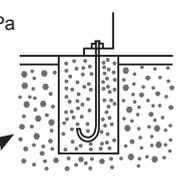

Since the results from the examination above, the anchor bolt has enough strength.

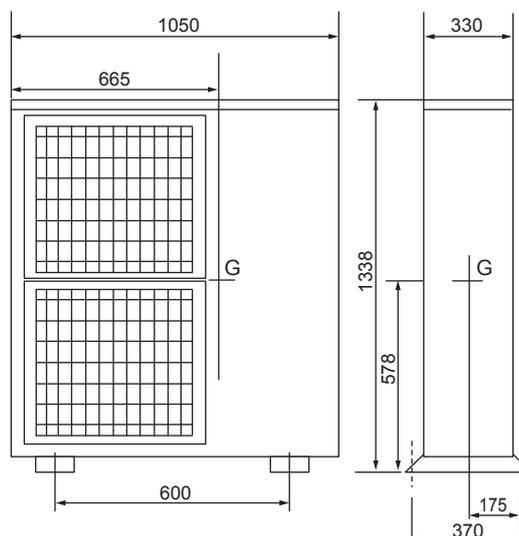

1.Type:

2.Model name:

3.Specification

- | | |
|---|---|
| (1) Unit mass | W= <input type="text" value="125"/> kg |
| (2) Anchor bolt | |
| 1.The total number of bolts | N= <input type="text" value="4"/> |
| 2.The size and shape | "=M <input type="text" value="10"/> type |
| 3.The axis section area per one bolt | A= <input type="text" value="78"/> mm ² = <input type="text" value="78 × 10<sup>-6"/> "/> m ² |
| 4.The total number of bolts in one side which be pulled stronger when the unit inverted | Nt= <input type="text" value="2"/> |
| (3) The height between the installing surface and the center of gravity of the unit | Hg= <input type="text" value="507"/> mm= <input type="text" value="0.507"/> m |
| (4) The bolt-span from the examination angle | L= <input type="text" value="370"/> mm= <input type="text" value="0.370"/> m |
| (5) The distance between the center of bolt and the center of gravity of the unit | Lg= <input type="text" value="175"/> mm(Lg≤L/2)= <input type="text" value="0.175"/> m |

4.The examination calculation (by rounding off to the first decimal place of each item)

- | | |
|--|--|
| (1) The horizontal seismic coefficient for designing | Kh= <input type="text" value="1.0"/> |
| (2) The vertical seismic coefficient for designing | Kv=Kh/2= <input type="text" value="0.5"/> |
| (3) The horizontal earthquake forces for designing | Fh=Kh·W·9.8= <input type="text" value="1225.0"/> N |
| (4) The vertical earthquake forces for designing | Fv=Kv·W·9.8= <input type="text" value="612.5"/> N |
| (5) The withdrawal strength of the anchor bolt | $R_b = \frac{F_h \cdot H_g - (W \cdot 9.8 - F_v) \cdot L_g}{L \cdot N_t}$ = <input type="text" value="694.4"/> N |
| (6) The shear forces of the anchor bolt | Q=Fh/N= <input type="text" value="306.3"/> N |
| (7) The stress arising to the anchor bolt | |
| 1.The tensile stress | $\sigma = R_b/A =$ <input type="text" value="8.9"/> MPa < ft=176.4MPa |
| 2.The shearing stress | $\tau = Q/A =$ <input type="text" value="3.9"/> MPa < fs=132.3MPa |
| 3.The stress when affected by both the shearing and the tensile at the same time | fts=1.4ft-1.6τ= <input type="text" value="240.2"/> MPa |
| | $\sigma =$ <input type="text" value="8.9"/> MPa < fts= <input type="text" value="176.0"/> MPa |
| (8) The construction way of the anchor bolt | |
| 1.The construction way of the anchor bolt | = <input type="text" value="Boxed J type anchor"/> |
| 2.The thickness of the concrete | = <input type="text" value="120"/> mm= <input type="text" value="0.120"/> m |
| 3.The length of buried part of bolt | = <input type="text" value="70"/> mm= <input type="text" value="0.070"/> m |
| 4.The permissible withdrawal weight | Ta= <input type="text" value="3136"/> N > Rb= <input type="text" value="694.4"/> N |

Since the results from the examination above, the anchor bolt has enough strength.

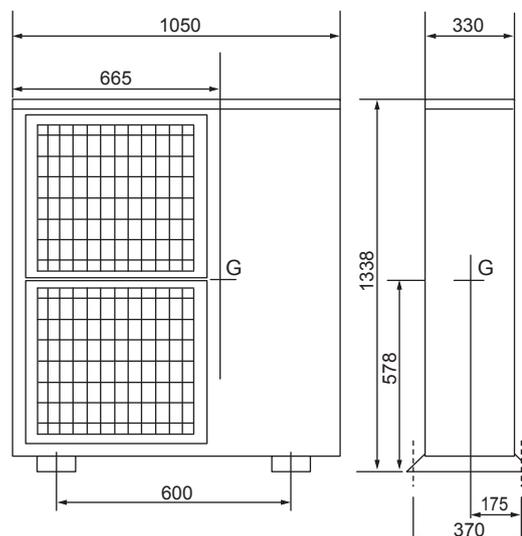

1.Type:

2.Model name:

3.Specification

- | | |
|---|---|
| (1) Unit mass | W= <input type="text" value="136"/> kg |
| (2) Anchor bolt | |
| 1.The total number of bolts | N= <input type="text" value="4"/> |
| 2.The size and shape | "=M <input type="text" value="10"/> type |
| 3.The axis section area per one bolt | A= <input type="text" value="78"/> mm ² = <input type="text" value="78 × 10<sup>-6"/> "/> m ² |
| 4.The total number of bolts in one side which be pulled stronger when the unit inverted | Nt= <input type="text" value="2"/> |
| (3) The height between the installing surface and the center of gravity of the unit | Hg= <input type="text" value="660"/> mm= <input type="text" value="0.660"/> m |
| (4) The bolt-span from the examination angle | L= <input type="text" value="370"/> mm= <input type="text" value="0.370"/> m |
| (5) The distance between the center of bolt and the center of gravity of the unit | Lg= <input type="text" value="180"/> mm(Lg≤L/2)= <input type="text" value="0.180"/> m |

4.The examination calculation (by rounding off to the first decimal place of each item)

- | | |
|--|--|
| (1) The horizontal seismic coefficient for designing | Kh= <input type="text" value="1.0"/> |
| (2) The vertical seismic coefficient for designing | Kv=Kh/2= <input type="text" value="0.5"/> |
| (3) The horizontal earthquake forces for designing | Fh=Kh·W·9.8= <input type="text" value="1332.8"/> N |
| (4) The vertical earthquake forces for designing | Fv=Kv·W·9.8= <input type="text" value="666.4"/> N |
| (5) The withdrawal strength of the anchor bolt | $R_b = \frac{F_h \cdot H_g - (W \cdot 9.8 - F_v) \cdot L_g}{L \cdot N_t}$ = <input type="text" value="1026.6"/> N |
| (6) The shear forces of the anchor bolt | Q=Fh/N= <input type="text" value="333.2"/> N |
| (7) The stress arising to the anchor bolt | |
| 1.The tensile stress | $\sigma = R_b/A =$ <input type="text" value="13.2"/> MPa < ft=176.4MPa |
| 2.The shearing stress | $\tau = Q/A =$ <input type="text" value="4.3"/> MPa < fs=132.3MPa |
| 3.The stress when affected by both the shearing and the tensile at the same time | fts=1.4ft-1.6τ= <input type="text" value="239.5"/> MPa
σ= <input type="text" value="13.2"/> MPa < fts= <input type="text" value="176.0"/> MPa |
| (8) The construction way of the anchor bolt | |
| 1.The construction way of the anchor bolt | = <input type="text" value="Boxed J type anchor"/> |
| 2.The thickness of the concrete | = <input type="text" value="120"/> mm= <input type="text" value="0.120"/> m |
| 3.The length of buried part of bolt | = <input type="text" value="70"/> mm= <input type="text" value="0.070"/> m |
| 4.The permissible withdrawal weight | Ta= <input type="text" value="3136"/> N > Rb= <input type="text" value="1026.6"/> N |

Since the results from the examination above, the anchor bolt has enough strength.

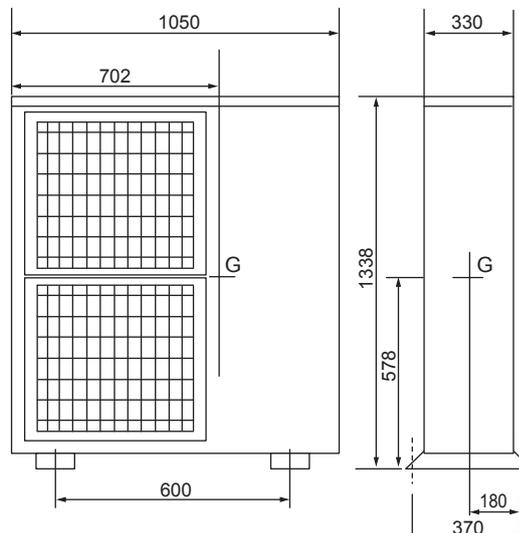

Display	Contents to be inspected (During operation)
U1	Abnormal high pressure (63H operated)
U2	Abnormal temperature of discharge/Comp. Surface, shortage of refrigerant
U3	Open/short (TH4, TH34(PUHZ-HW·HA2, SW·HA, SHW·HA/KA, FRP·VHA), TH33(PUHZ-W·HA(2)), RT62(SUHZ-SW))
U4	Open/short (TH3, TH6, TH7, TH8, TH32 and TH33(PUHZ-W112VHA, HW·HA2, SW·HA, SHW·HA/KA),RT61, RT64, RT65,RT68(SUHZ-SW))
U5	Abnormal temperature of heatsink
U6	Abnormality in power module
U7	Abnormal super heat
U8	Abnormality in outdoor fan motor
U9	Voltage error, Current sensor error (Input current)
Ud	Overheat error
UF	Compressor overcurrent shutoff (When Comp. locked)
UH	Current sensor error (Comp. current), Input overcurrent shutoff
UL	Abnormal low pressure (63L operated)
UP	Compressor overcurrent shutoff
P4	Drain sensor abnormality, Contact failure of drain float switch
P5	Drain over flow protection
P6	Freezing/overheating protection
P8	Abnormality temperature of pipe
PA	Water leakage
Pb	Fan trouble (Indoor unit)
UE	Abnormal pressure (63HS operated)
PE	Abnormal temperature of inlet water
Ed	Serial communication error
EA, Eb, EC	Incorrect wiring indoor / outdoor unit connection
E6 - E9	Indoor / Outdoor unit communication error
E0, E3 - E5	Remote communication error
EE, EF	Combination error, undefined error
A0	Duplex address error
A2	Transmission processor hardware error
A3	Transmission bus BUSY error
A6	Signal communication error with transmission processor
A7	No ACK error
A8	No response frame error
L6	Circulation water freeze protection

Display	Contents to be inspected (When power is turned on)
F3	63L connector (red) open
F5	63H connector (yellow) open
F9	2 connectors (63H and 63L) open
FC	Outdoor control system error

10.1. Packaged-type units (Power inverter / ZUBADAN)

PUHZ-W50VHA2(-BS), PUHZ-W85VHA2(-BS), PUHZ-W112VHA(-BS)

PUHZ-HW112YHA2(-BS), PUHZ-HW140VHA2(-BS), PUHZ-HW140YHA2(-BS)

(mm)

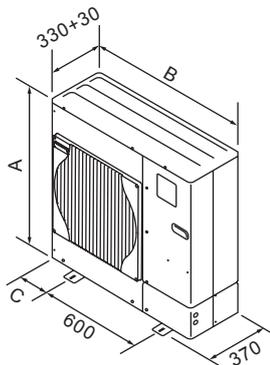

Fig. 1-1

Models	A(mm)	B(mm)	C(mm)
50	740	950	175
85	943	950	175
112	1350	1020	210
140	1350	1020	210

■ Choosing the outdoor unit installation location

- Avoid locations where the unit is exposed to direct sunlight or other sources of heat.
- Select a location where noise emitted by the unit does not disturb neighbors.
- Select a location where easy wiring and pipe access to the power source is available.
- Avoid locations where combustible gases may leak, be produced, flow, or accumulate.
- Note that condensate water may be produced by the unit during operation.
- Select a level location that can bear the weight and vibration of the unit.
- Avoid locations where the unit can be covered with snow. In areas where heavy snow fall is anticipated, special precautions must be taken to prevent the snow from blocking the air intake such as to install the unit at higher position or installing a hood on the air intake. This can reduce the airflow and the unit may not operate properly.
- Avoid locations where the unit is exposed to oil, steam, or sulfuric gas.
- Make sure to hold the handles to transport the unit. Do not hold the base of the unit, as there is a risk that hands or fingers may be pinched.

■ Outline dimensions (Outdoor unit) (Fig. 1-1)

■ Windy location installation

When installing the outdoor unit on a rooftop or other location where the unit is exposed to strong wind, do not face the air outlet of the unit directly into the winds. Strong wind entering the air outlet may impede the normal airflow and it may result in a malfunction.

The following shows three examples of precautions against strong winds.

- ① Face the air outlet towards the nearest available wall keeping about 50 cm distance. (Fig. 1-2)
- ② Install an optional air guide if the unit is installed in a location where strong winds such as a typhoon, etc. may directly blow to the air outlet. (Fig. 1-3)
 - Ⓐ Air protection guide
- ③ Position the unit so that the outlet air can blow at right angle to the seasonal wind direction, if possible. (Fig. 1-4)
 - Ⓑ Wind direction

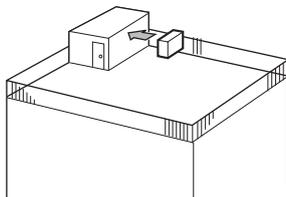

Fig. 1-2

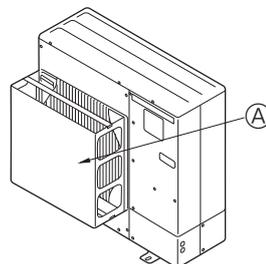

Fig. 1-3

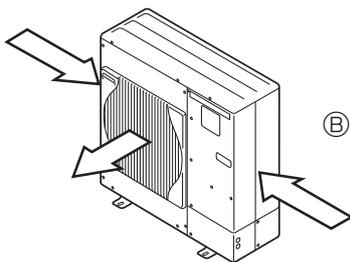

Fig. 1-4

■ NECESSARY SPACE TO INSTALL

(1) When installing a single outdoor unit (Refer to the next page)

Minimum dimensions are as follows, except for Max., meaning Maximum dimensions, indicated.

The figures in parentheses are for 112/140 models.

Refer to the figures for each case.

- ① Obstacles at rear only (Fig. 1-5)
- ② Obstacles at rear and above only (Fig. 1-6)
- ③ Obstacles at rear and sides only (Fig. 1-7)
- ④ Obstacles at front only (Fig. 1-8)
 - *When using an optional air outlet guide, the clearance for 112/140 models is 500 mm or more.
- ⑤ Obstacles at front and rear only (Fig. 1-9)
 - *When using an optional air outlet guide, the clearance for 112/140 models is 500 mm or more.
- ⑥ Obstacles at rear, sides, and above only (Fig. 1-10)
 - *Do not install the optional air outlet guides for upward airflow.

(2) When installing multiple outdoor units (Refer to the next page)

Leave 10 mm space or more between the units.

The figures in parentheses are for 112/140 models.

- ① Obstacles at rear only (Fig. 1-11)
- ② Obstacles at rear and above only (Fig. 1-12)
 - No more than 3 units must be installed side by side. In addition, leave space as shown.
 - Do not install the optional air outlet guides for upward airflow.
- ③ Obstacles at front only (Fig. 1-13)
 - *When using an optional air outlet guide, the clearance for 112/140 models is 1000 mm or more.
- ④ Obstacles at front and rear only (Fig. 1-14)
 - *When using an optional air outlet guide, the clearance for 112/140 models is 1000 mm or more.
- ⑤ Single parallel unit arrangement (Fig. 1-15)
 - *When using an optional air outlet guide installed for upward airflow, the clearance is 500 (1000) mm or more.
- ⑥ Multiple parallel unit arrangement (Fig. 1-16)
 - *When using an optional air outlet guide installed for upward airflow, the clearance is 1000 (1500) mm or more.
- ⑦ Stacked unit arrangement (Fig. 1-17)
 - The units can be stacked up to 2 units high.
 - No more than 2 stacked units must be installed side by side. In addition, leave space as shown.

UNIT : mm
 () : W112
 HW112,140

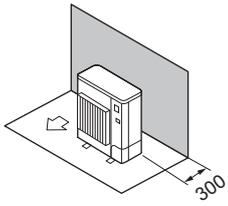

Fig. 1-5

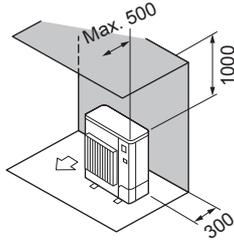

Fig. 1-6

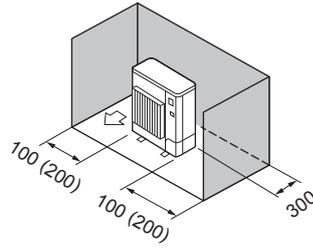

Fig. 1-7

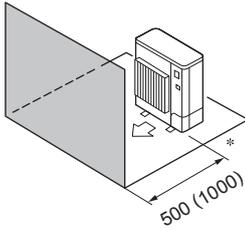

Fig. 1-8

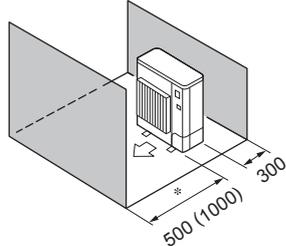

Fig. 1-9

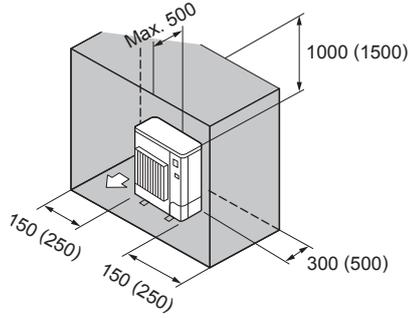

Fig. 1-10

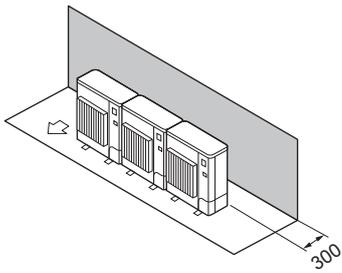

Fig. 1-11

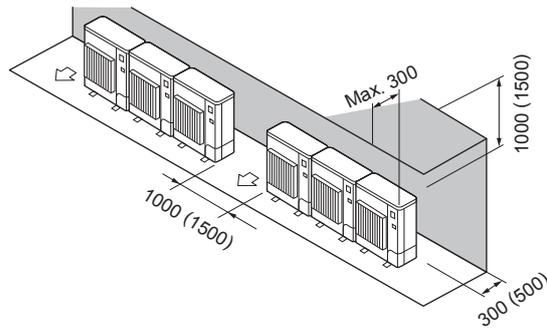

Fig. 1-12

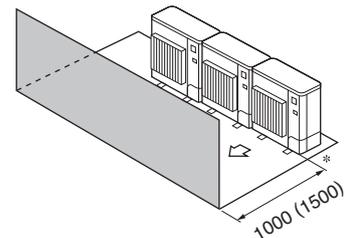

Fig. 1-13

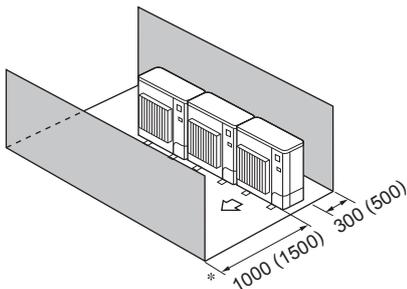

Fig. 1-14

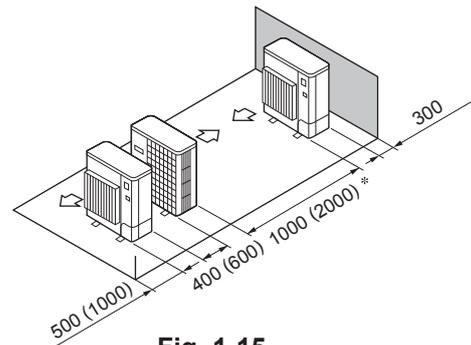

Fig. 1-15

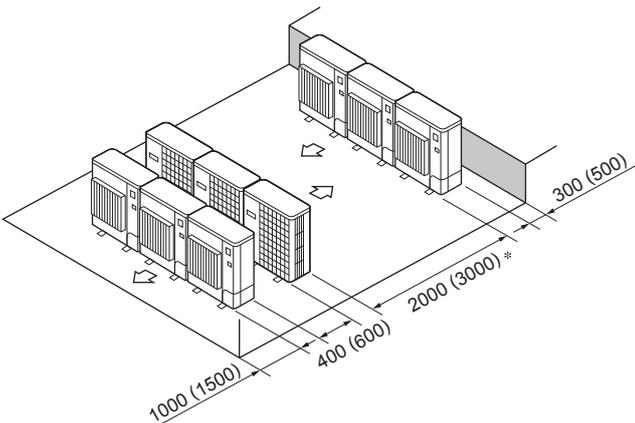

Fig. 1-16

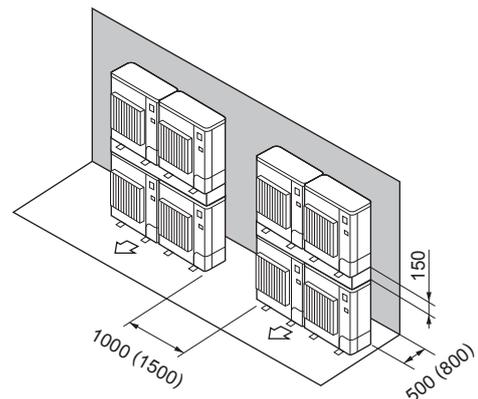

Fig. 1-17

PUHZ-W85VAA(-BS), PUHZ-W85YAA(-BS)
 PUHZ-W112VAA(-BS), PUHZ-W112YAA(-BS)

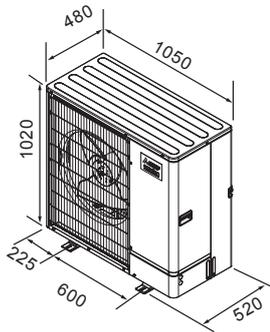

Fig. 1-18

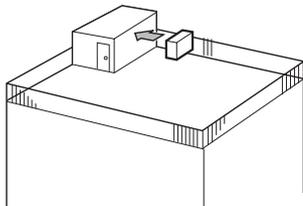

Fig. 1-19

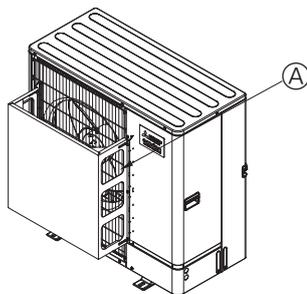

Fig. 1-20

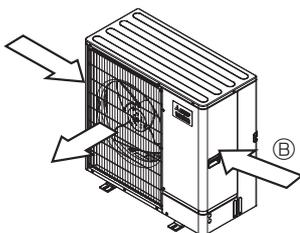

Fig. 1-21

■ Choosing the outdoor unit installation location

- Avoid locations exposed to direct sunlight or other sources of heat.
- Select a location from which noise emitted by the unit will not inconvenience neighbors.
- Select a location permitting easy wiring and pipe access to the power source and indoor unit.
- Avoid locations where combustible gases may leak, be produced, flow, or accumulate.
- Note that water may drain from the unit during operation.
- Select a level location that can bear the weight and vibration of the unit.
- Avoid locations where the unit can be covered by snow. In areas where heavy snow fall is anticipated, special precautions such as raising the installation location or installing a hood on the air intake must be taken to prevent the snow from blocking the air intake or blowing directly against it. This can reduce the airflow and a malfunction may result.
- Avoid locations exposed to oil, steam, or sulfuric gas.
- Use the transportation handles of the outdoor unit to transport the unit. If the unit is carried from the bottom, hands or fingers may be pinched.

■ Outline dimensions (Outdoor unit) (Fig. 1-18)

■ Ventilation and service space

(1) Windy location installation

When installing the outdoor unit on a rooftop or other location unprotected from the wind, situate the air outlet of the unit so that it is not directly exposed to strong winds. Strong wind entering the air outlet may impede the normal airflow and a malfunction may result.

The following shows three examples of precautions against strong winds.

- ① Face the air outlet towards the nearest available wall about 35 cm away from the wall. (Fig. 1-19)
 - ② Install an optional air guide if the unit is installed in a location where strong winds from a typhoon, etc. may directly enter the air outlet. (Fig. 1-20) A Air outlet guide
 - ③ Position the unit so that the air outlet blows perpendicularly to the seasonal wind direction, if possible. (Fig. 1-21)
- ⓑ Wind direction

(2) When installing a single outdoor unit (Refer to the next page)

Minimum dimensions are as follows, except for Max., meaning Maximum dimensions, indicated.

Refer to the figures for each case.

- ① Obstacles at rear only (Fig. 1-22)
- ② Obstacles at rear and above only (Fig. 1-23)
 - Do not install the optional air outlet guides for upward airflow.
- ③ Obstacles at rear and sides only (Fig. 1-24)
- ④ Obstacles at front only (Fig. 1-25)
- ⑤ Obstacles at front and rear only (Fig. 1-26)
- ⑥ Obstacles at rear, sides, and above only (Fig. 1-27)
 - Do not install the optional air outlet guides for upward airflow.

(3) When installing multiple outdoor units (Refer to the next page)

Leave 50 mm space or more between the units.

Refer to the figures for each case.

- ① Obstacles at rear only (Fig. 1-28)
- ② Obstacles at rear and above only (Fig. 1-29)
 - No more than 3 units must be installed side by side. In addition, leave space as shown.
 - Do not install the optional air outlet guides for upward airflow.
- ③ Obstacles at front only (Fig. 1-30)
- ④ Obstacles at front and rear only (Fig. 1-31)
- ⑤ Single parallel unit arrangement (Fig. 1-32)
 - * When using an optional air outlet guide installed for upward airflow, the clearance is 500 mm or more.
- ⑥ Multiple parallel unit arrangement (Fig. 1-33)
 - * When using an optional air outlet guide installed for upward airflow, the clearance is 1000 mm or more.
- ⑦ Stacked unit arrangement (Fig. 1-34)
 - The units can be stacked up to two units high.
 - No more than 2 stacked units must be installed side by side. In addition, leave space as shown.

Note: The space should be provided for optimizing the performance of the unit. Provide the proper space for water piping.

UNIT : mm
() : W112
HW112,140

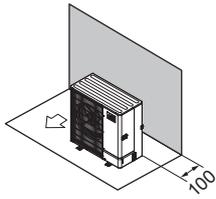

Fig. 1-22

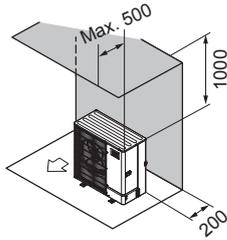

Fig. 1-23

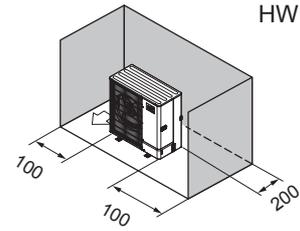

Fig. 1-24

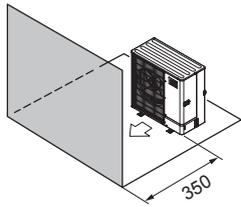

Fig. 1-25

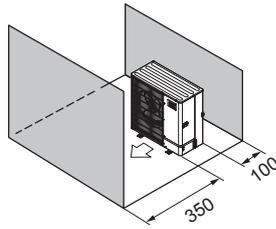

Fig. 1-26

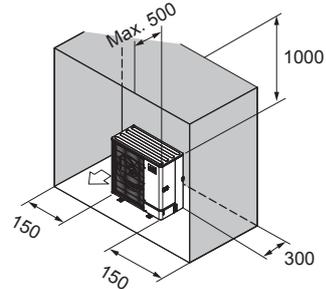

Fig. 1-27

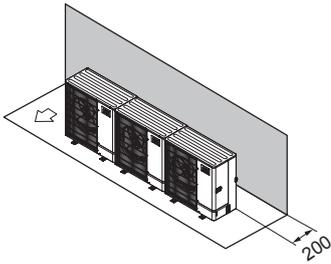

Fig. 1-28

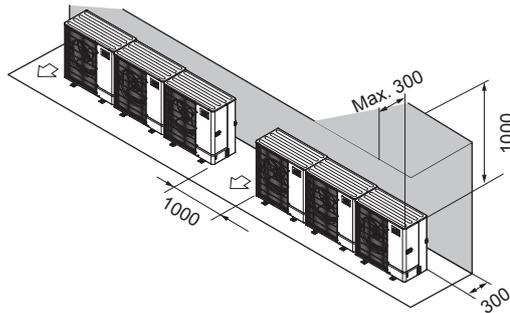

Fig. 1-29

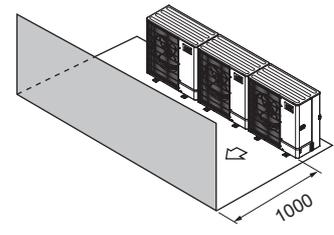

Fig. 1-30

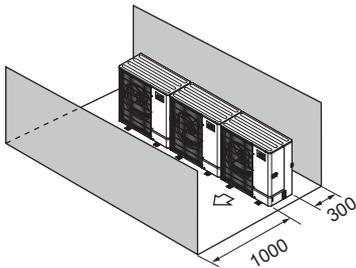

Fig. 1-31

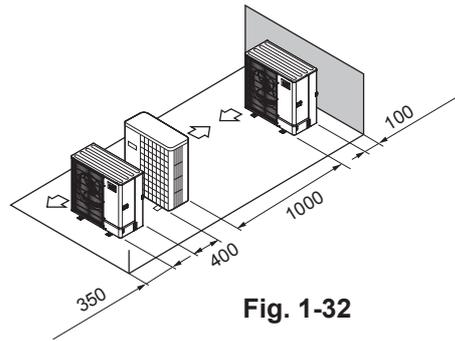

Fig. 1-32

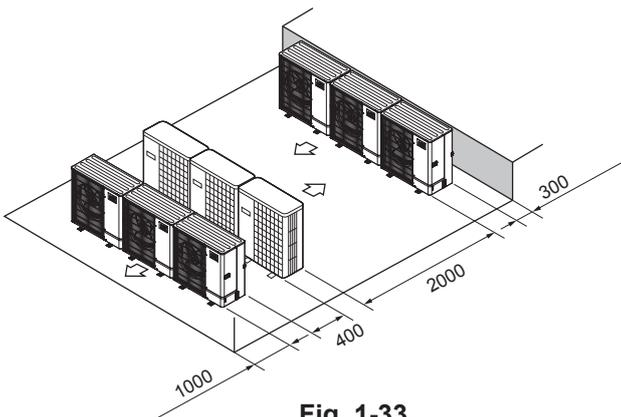

Fig. 1-33

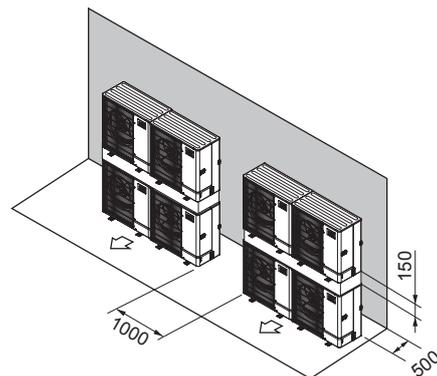

Fig. 1-34

10.2 Split-type units (Eco inverter / Power inverter) SUHZ-SW45VA(H)

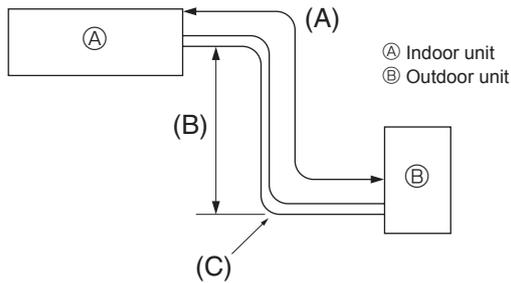

Fig. 1

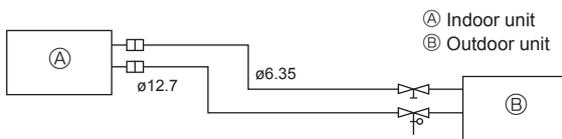

Fig. 2

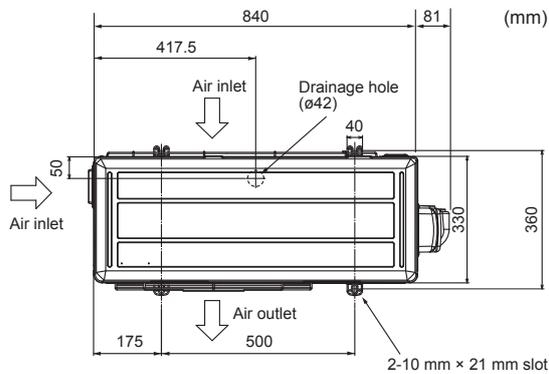

Fig. 3

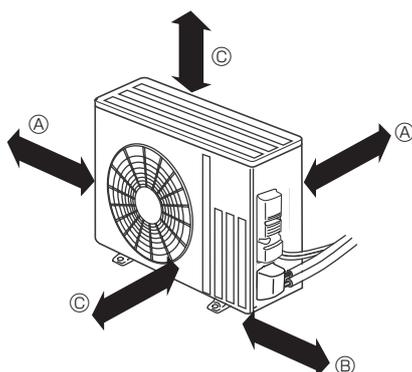
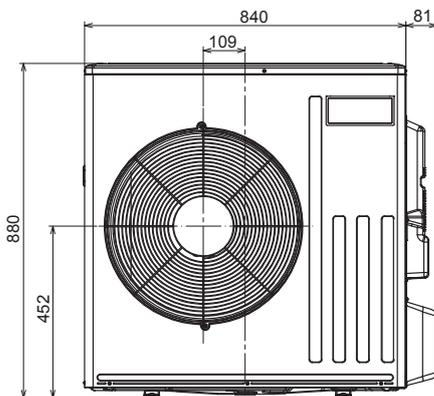

Fig. 4

Refrigerant pipe (Fig. 1, 2)

► Check that the difference between the heights of the indoor and outdoor units, the length of refrigerant pipe, and the number of bends in the pipe are within the limits shown below.

Models	(A) Pipe length (one way)	(B) Height difference	(C) Number of bends (one way)
SUHZ-SW45	Max. 30 m	Max. 30 m	Max. of 10

- Height difference limitations are binding regardless of which unit, indoor or outdoor, is positioned higher.
- Refrigerant adjustment ... If pipe length exceeds 7 m, additional refrigerant (R410A) charge is required.
(The outdoor unit is charged with refrigerant for pipe length up to 7 m.)

Pipe length	Up to 7 m	No additional charge is required.
	Exceeding 7 m	Additional charge is required. (Refer to the table below.)
Refrigerant to be added	SUHZ-SW45	25 g × (refrigerant piping length (m) - 7)

Piping preparation

- Refrigerant pipes of 3, 5, 7, 10 and 15 m are available as optional items.

(1) Table below shows the specifications of pipes commercially available.

Model	Pipe	Outer diameter		Min. wall thickness	Insulation thickness	Insulation material
		mm	inch			
SUHZ-SW45	For liquid	6.35	1/4	0.8 mm	8 mm	Heat resisting foam plastic 0.045 specific gravity
	For gas	12.7	1/2	0.8 mm	8 mm	

- (2) Ensure that the 2 refrigerant pipes are well insulated to prevent condensation.
- (3) Refrigerant pipe bending radius must be 100 mm or more.

⚠ Caution:

Using careful insulation of specified thickness. Excessive thickness prevents storage behind the indoor unit and smaller thickness causes dew drippage.

Ventilation and service space (Fig. 3, 4)

- Ⓐ 100 mm or more
- Ⓑ 350 mm or more
- Ⓒ 500 mm or more

When the piping is to be attached to a wall containing metals (tin plated) or metal netting, use a chemically treated wooden piece 20 mm or thicker between the wall and the piping or wrap 7 to 8 turns of insulation vinyl tape around the piping.

Units should be installed by licensed contractor accordingly to local code requirement.

Note:

When operating the outdoor unit in low outside temperature, be sure to follow the instructions described below.

- Never install the outdoor unit in a place where its air inlet/outlet side may be exposed directly to wind.
- To prevent exposure to wind, install the outdoor unit with its air inlet side facing the wall.
- To prevent exposure to wind, it is recommended to install a baffle board on the air outlet side of the outdoor unit.

PUHZ-SW50VKA(-BS)

PUHZ-SW75-120VHA(-BS), PUHZ-SW100/120YHA(-BS), PUHZ-SW160/200YKA(-BS)

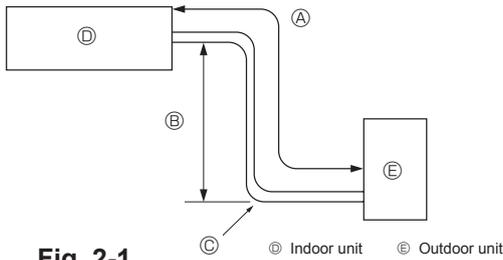

Fig. 2-1

Refrigerant pipe (Fig. 2-1)

► Check that the difference between the heights of the indoor and outdoor units, the length of refrigerant pipe, and the number of bends in the pipe are within the limits shown below.

Models	Ⓐ Pipe length (one way)	Ⓑ Height difference	Ⓒ Number of bends (one way)
SW50	2 m - 40 m	Max. 30 m	Max. 15
SW75	2 m - 40 m	Max. 30 m	Max. 15
SW100,120	2 m - 75 m	Max. 30 m	Max. 15
SW160,200	2 m - 80 m	Max. 30 m	Max. 15

• Height difference limitations are binding regardless of which unit, indoor or outdoor, is positioned higher.

Choosing the outdoor unit installation location

- Avoid locations exposed to direct sunlight or other sources of heat.
- Select a location from which noise emitted by the unit will not inconvenience neighbors.
- Select a location permitting easy wiring and pipe access to the power source and indoor unit.
- Avoid locations where combustible gases may leak, be produced, flow, or accumulate.
- Note that water may drain from the unit during operation.
- Select a level location that can bear the weight and vibration of the unit.
- Avoid locations where the unit can be covered by snow. In areas where heavy snow fall is anticipated, special precautions such as raising the installation location or installing a hood on the air intake must be taken to prevent the snow from blocking the air intake or blowing directly against it. This can reduce the airflow and a malfunction may result.
- Avoid locations exposed to oil, steam, or sulfuric gas.
- Use the transportation handles of the outdoor unit to transport the unit. If the unit is carried from the bottom, hands or fingers may be pinched.

Outline dimensions (Outdoor unit) (Fig. 2-2)

Ventilation and service space

(1) Windy location installation

When installing the outdoor unit on a rooftop or other location unprotected from the wind, situate the air outlet of the unit so that it is not directly exposed to strong winds. Strong wind entering the air outlet may impede the normal airflow and a malfunction may result. The following shows three examples of precautions against strong winds.

- ① Face the air outlet towards the nearest available wall about 50 cm away from the wall. (Fig. 2-3)
- ② Install an optional air guide if the unit is installed in a location where strong winds from a typhoon, etc. may directly enter the air outlet. (Fig. 2-4)
 - Ⓐ Air protection guide
- ③ Position the unit so that the air outlet blows perpendicularly to the seasonal wind direction, if possible. (Fig. 2-5)
 - Ⓑ Wind direction

(2) When installing a single outdoor unit (Refer to the next page)

Minimum dimensions are as follows, except for Max., meaning Maximum dimensions, indicated.

The figures in parentheses are for SW100-200 models.

Refer to the figures for each case.

- ① Obstacles at rear only (Fig. 2-6)
- ② Obstacles at rear and above only (Fig. 2-7)
- ③ Obstacles at rear and sides only (Fig. 2-8)
 - * 350 for SW50.
- ④ Obstacles at front only (Fig. 2-9)
 - * When using an optional air outlet guide, the clearance for SW100-200 models is 500 mm or more.
- ⑤ Obstacles at front and rear only (Fig. 2-10)
 - * When using an optional air outlet guide, the clearance for SW100-200 models is 500 mm or more.
- ⑥ Obstacles at rear, sides, and above only (Fig. 2-11)
 - * 350 for SW50.
 - Do not install the optional air outlet guides for upward airflow.

(3) When installing multiple outdoor units (Refer to the next page)

Leave 350 mm for SW50 and 10 mm for SW75-120 and 50 mm for SW160, 200 space or more between the units. The figures in parentheses are for SW100-200 models.

- ① Obstacles at rear only (Fig. 2-12)
- ② Obstacles at rear and above only (Fig. 2-13)
 - No more than 3 units must be installed side by side. In addition, leave space as shown.
 - Do not install the optional air outlet guides for upward airflow.
- ③ Obstacles at front only (Fig. 2-14)
 - * When using an optional air outlet guide, the clearance for SW100-200 models is 1000 mm or more.
- ④ Obstacles at front and rear only (Fig. 2-15)
 - * When using an optional air outlet guide, the clearance for SW100-200 models is 1000 mm or more.
- ⑤ Single parallel unit arrangement (Fig. 2-16)
 - * When using an optional air outlet guide installed for upward airflow, the clearance is 500 (1000) mm or more.
- ⑥ Multiple parallel unit arrangement (Fig. 2-17)
 - * When using an optional air outlet guide installed for upward airflow, the clearance is 1000 (1500) mm or more.
- ⑦ Stacked unit arrangement (Fig. 2-18)
 - The units can be stacked up to two units high.
 - No more than 2 stacked units must be installed side by side. In addition, leave space as shown.

SW50

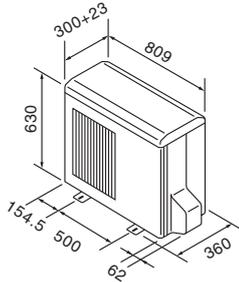

SW75

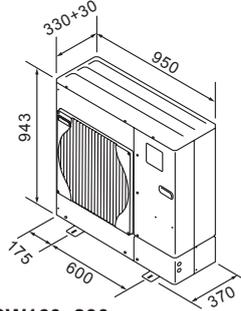

SW100, 120

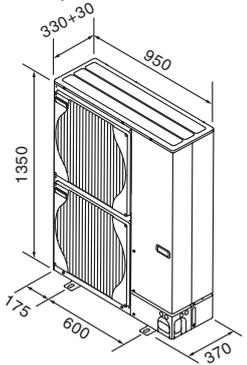

SW160, 200

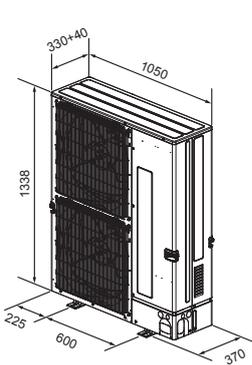

Fig. 2-2

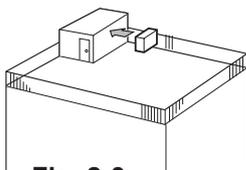

Fig. 2-3

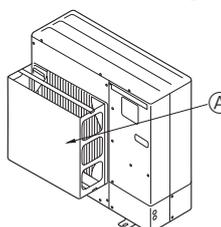

Fig. 2-4

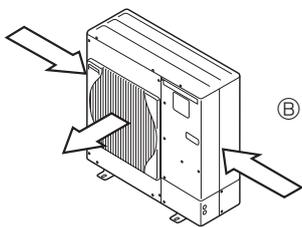

Fig. 2-5

UNIT : mm
() : SW100-200

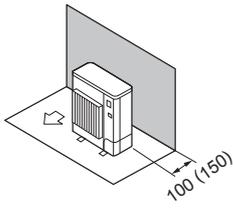

Fig. 2-6

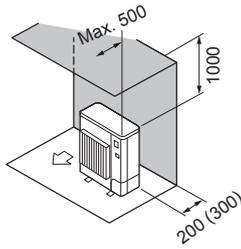

Fig. 2-7

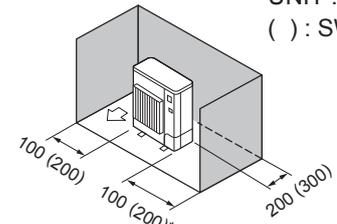

Fig. 2-8

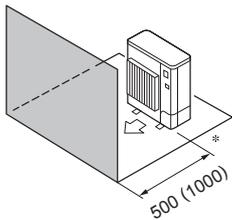

Fig. 2-9

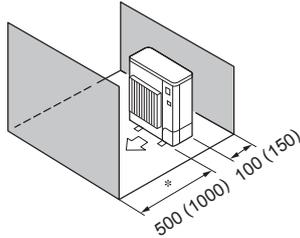

Fig. 2-10

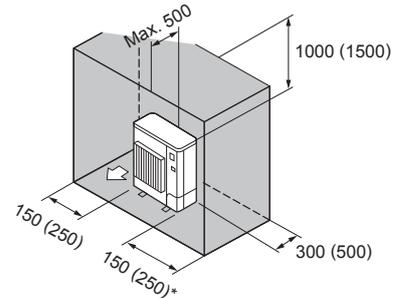

Fig. 2-11

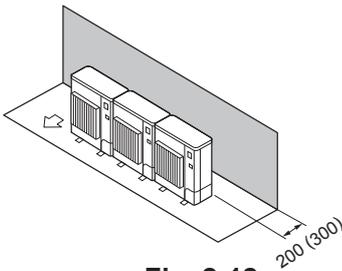

Fig. 2-12

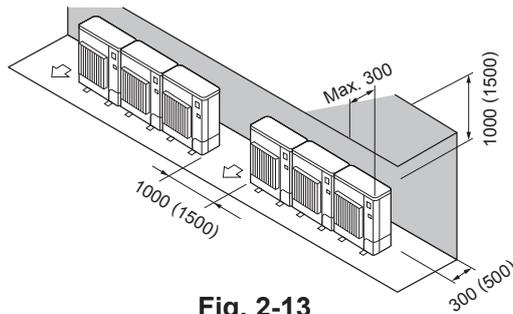

Fig. 2-13

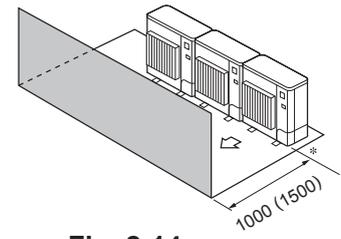

Fig. 2-14

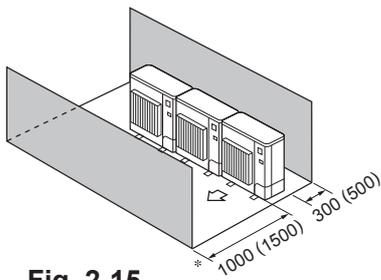

Fig. 2-15

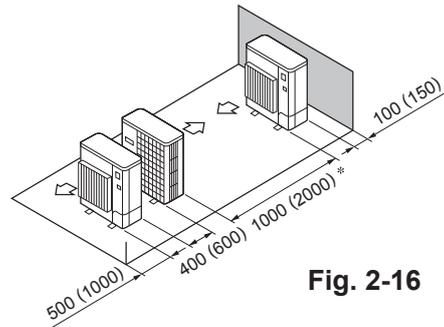

Fig. 2-16

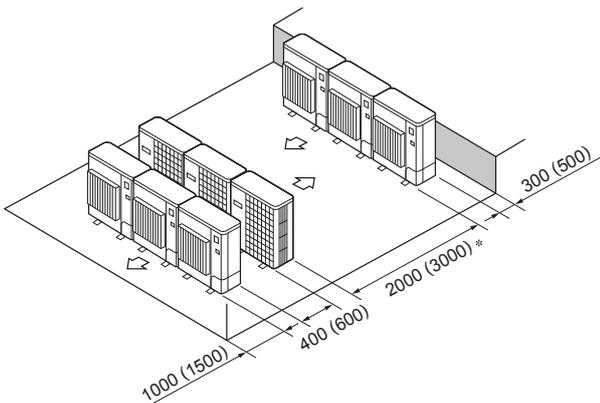

Fig. 2-17

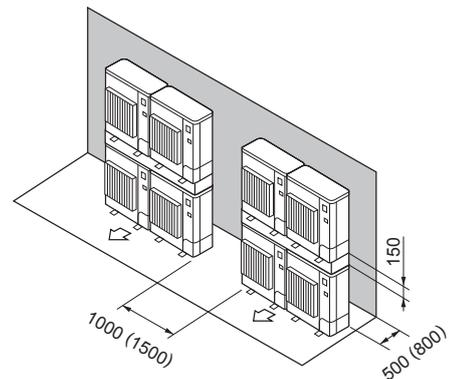

Fig. 2-18

PUHZ-SW75/100VAA(-BS), PUHZ-SW75/100YAA(-BS)

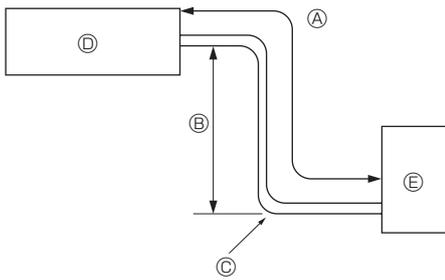

Fig. 2-19

(mm)

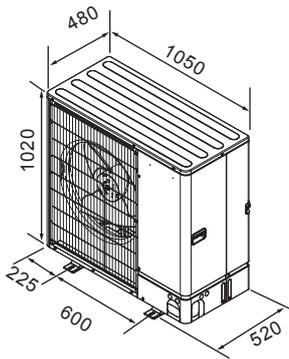

Fig. 2-20

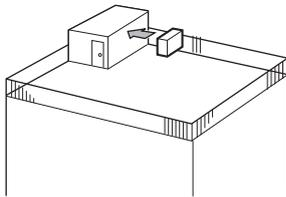

Fig. 2-21

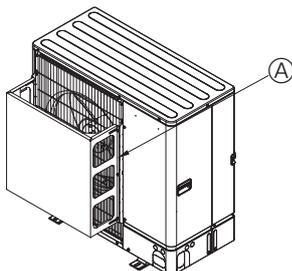

Fig. 2-22

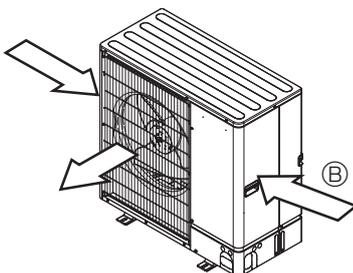

Fig. 2-23

Refrigerant pipe (Fig. 2-19)

▶ Check that the difference between the heights of the indoor and outdoor units, the length of refrigerant pipe, and the number of bends in the pipe are within the limits shown below.

Model	Ⓐ Pipe length (one way)	Ⓑ Height difference	Ⓒ Number of bends (one way)
SW75	2 m - 40 m	Max. 30 m	Max. 15
SW100	2 m - 75 m	Max. 30 m	Max. 15

• Height difference limitation is defined regardless of which unit, indoor or outdoor, is positioned higher.

- Ⓓ Indoor unit
- Ⓔ Outdoor unit

Choosing the outdoor unit installation location

- Avoid locations exposed to direct sunlight or other sources of heat.
- Select a location from which noise emitted by the unit will not inconvenience neighbors.
- Select a location permitting easy wiring and pipe access to the power source and indoor unit.
- Avoid locations where combustible gases may leak, be produced, flow, or accumulate.
- Note that water may drain from the unit during operation.
- Select a level location that can bear the weight and vibration of the unit.
- Avoid locations where the unit can be covered by snow. In areas where heavy snow fall is anticipated, special precautions such as raising the installation location or installing a hood on the air intake must be taken to prevent the snow from blocking the air intake or blowing directly against it. This can reduce the airflow and a malfunction may result.
- Avoid locations exposed to oil, steam, or sulfuric gas.
- Use the transportation handles of the outdoor unit to transport the unit. If the unit is carried from the bottom, hands or fingers may be pinched.

Outline dimensions (Outdoor unit) (Fig. 2-20)

Ventilation and service space

(1) Windy location installation

When installing the outdoor unit on a rooftop or other location unprotected from the wind, situate the air outlet of the unit so that it is not directly exposed to strong winds. Strong wind entering the air outlet may impede the normal airflow and a malfunction may result.

The following shows three examples of precautions against strong winds.

- ① Face the air outlet towards the nearest available wall about 35 cm away from the wall. (Fig. 2-21)
- ② Install an optional air guide if the unit is installed in a location where strong winds from a typhoon, etc. may directly enter the air outlet. (Fig. 2-22)
 - Ⓐ Air outlet guide
- ③ Position the unit so that the air outlet blows perpendicularly to the seasonal wind direction, if possible. (Fig. 2-23)
 - Ⓑ Wind direction

(2) When installing a single outdoor unit (Refer to the next page)

Minimum dimensions are as follows, except for Max., meaning Maximum dimensions, indicated. Refer to the figures for each case.

- ① Obstacles at rear only (Fig. 2-24)
- ② Obstacles at rear and above only (Fig. 2-25)
 - Do not install the optional air outlet guides for upward airflow.
- ③ Obstacles at rear and sides only (Fig. 2-26)
- ④ Obstacles at front only (Fig. 2-27)
- ⑤ Obstacles at front and rear only (Fig. 2-28)
- ⑥ Obstacles at rear, sides, and above only (Fig. 2-29)
 - Do not install the optional air outlet guides for upward airflow.

(3) When installing multiple outdoor units (Refer to the next page)

Leave 50 mm space or more between the units.

Refer to the figures for each case.

- ① Obstacles at rear only (Fig. 2-30)
- ② Obstacles at rear and above only (Fig. 2-31)
 - No more than 3 units must be installed side by side. In addition, leave space as shown.
 - Do not install the optional air outlet guides for upward airflow.
- ③ Obstacles at front only (Fig. 2-32)
- ④ Obstacles at front and rear only (Fig. 2-33)
- ⑤ Single parallel unit arrangement (Fig. 2-34)
 - * When using an optional air outlet guide installed for upward airflow, the clearance is 500 mm or more.
- ⑥ Multiple parallel unit arrangement (Fig. 2-35)
 - * When using an optional air outlet guide installed for upward airflow, the clearance is 1000 mm or more.
- ⑦ Stacked unit arrangement (Fig. 2-36)
 - The units can be stacked up to two units high.
 - No more than 2 stacked units must be installed side by side. In addition, leave space as shown.

UNIT : mm

Outdoor unit

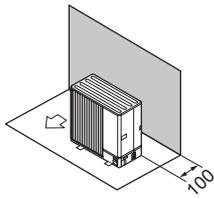

Fig. 2-24

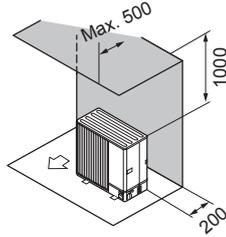

Fig. 2-25

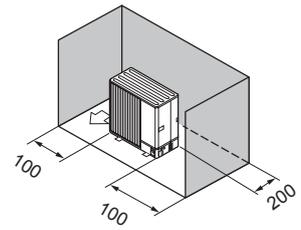

Fig. 2-26

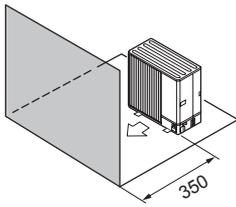

Fig. 2-27

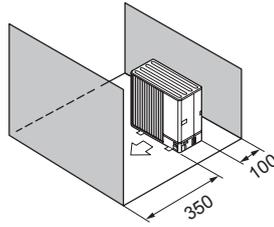

Fig. 2-28

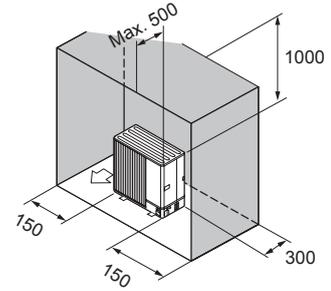

Fig. 2-29

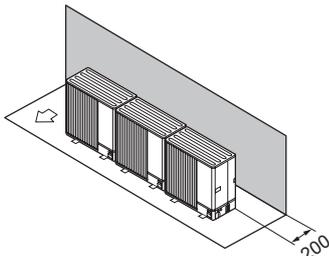

Fig. 2-30

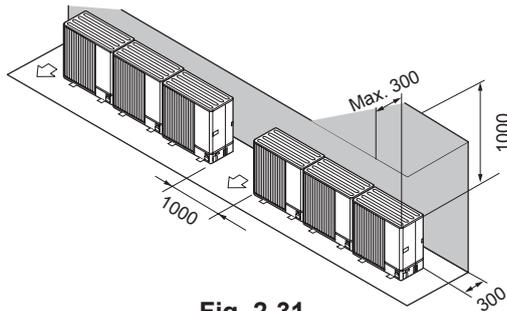

Fig. 2-31

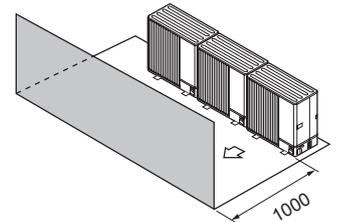

Fig. 2-32

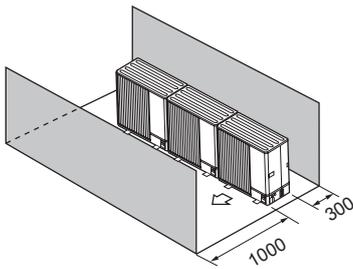

Fig. 2-33

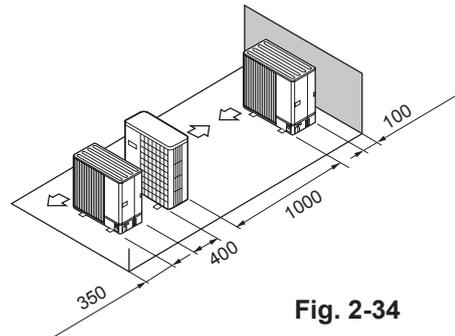

Fig. 2-34

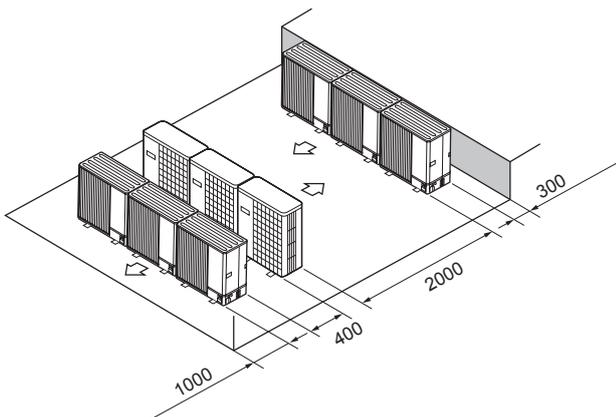

Fig. 2-35

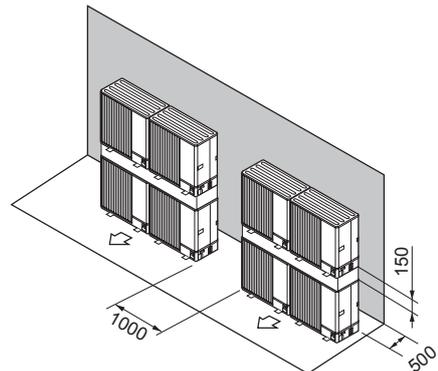

Fig. 2-36

10.3 Split-type units (Mr.SLIM+) PUHZ-FRP71VHA2

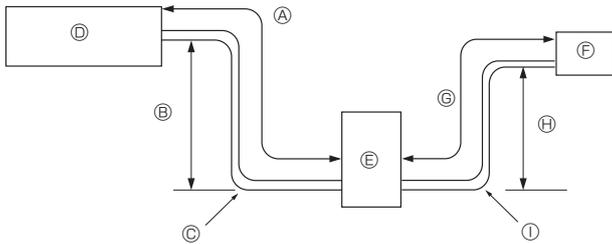

Fig. 3-1

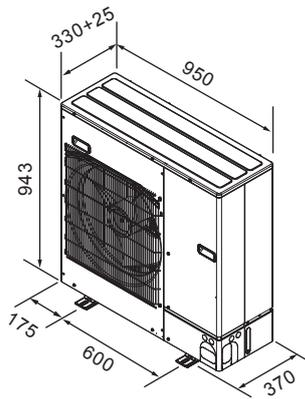

Fig. 3-2

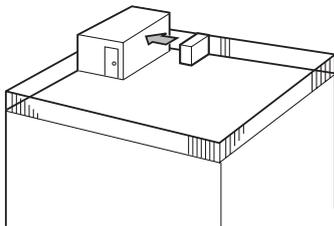

Fig. 3-3

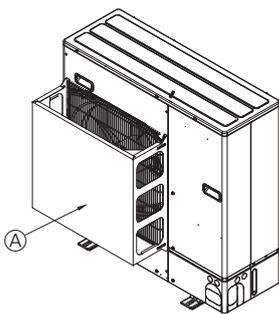

Fig. 3-4

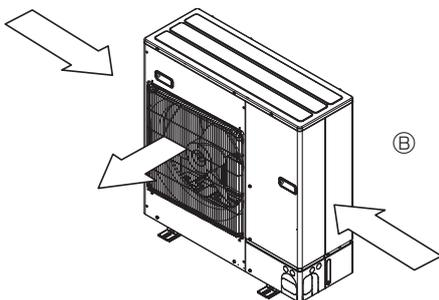

Fig. 3-5

Refrigerant pipe (Fig. 3-1)

Check that the difference between the heights of the indoor and outdoor units, the length of refrigerant pipe, and the number of bends in the pipe are within the limits shown below.

Ⓐ, Ⓒ Pipe length (one way)	Ⓑ, Ⓓ Height difference	Ⓔ, Ⓚ Number of bends (one way)
Max. 30 m for each	Max. 20 m for each	Max. 15 for each

- Height difference limitations are binding regardless of which unit, indoor or outdoor, is positioned higher.
- Ⓓ Indoor unit
- Ⓔ Outdoor unit
- Ⓒ Cylinder unit or Hydrobox

Choosing the outdoor unit installation location

- Avoid locations exposed to direct sunlight or other sources of heat.
- Select a location from which noise emitted by the unit will not inconvenience neighbors.
- Select a location permitting easy wiring and pipe access to the power source and indoor unit.
- Avoid locations where combustible gases may leak, be produced, flow, or accumulate.
- Note that water may drain from the unit during operation.
- Select a level location that can bear the weight and vibration of the unit.
- Avoid locations where the unit can be covered by snow. In areas where heavy snow fall is anticipated, special precautions such as raising the installation location or installing a hood on the air intake must be taken to prevent the snow from blocking the air intake or blowing directly against it. This can reduce the airflow and a malfunction may result.
- Avoid locations exposed to oil, steam, or sulfuric gas.
- Use the transportation handles of the outdoor unit to transport the unit. If the unit is carried from the bottom, hands or fingers may be pinched.

Outline dimensions (Outdoor unit) (Fig. 3-2)

Ventilation and service space

(1) Windy location installation

When installing the outdoor unit on a rooftop or other location unprotected from the wind, situate the air outlet of the unit so that it is not directly exposed to strong winds. Strong wind entering the air outlet may impede the normal airflow and a malfunction may result.

The following shows three examples of precautions against strong winds.

- Face the air outlet towards the nearest available wall about 50 cm away from the wall. (Fig. 3-3)
- Install an optional air guide if the unit is installed in a location where strong winds from a typhoon, etc. may directly enter the air outlet. (Fig. 3-4)
 - Ⓐ Air protection guide
- Position the unit so that the air outlet blows perpendicularly to the seasonal wind direction, if possible. (Fig. 3-5)
 - Ⓑ Wind direction

(2) When installing a single outdoor unit (Refer to the last page)

Minimum dimensions are indicated as follows, except for Max., meaning Maximum dimensions.

Refer to the figures for each case.

- Obstacles at rear only (Fig. 3-6)
- Obstacles at rear and above only (Fig. 3-7)
- Obstacles at rear and sides only (Fig. 3-8)
- Obstacles at front only (Fig. 3-9)
- Obstacles at front and rear only (Fig. 3-10)
- Obstacles at rear, sides, and above only (Fig. 3-11)
 - Do not install the optional air outlet guides for upward airflow.

(3) When installing multiple outdoor units (Refer to the last page)

Leave 10 mm space or more between the units.

- Obstacles at rear only (Fig. 3-12)
- Obstacles at rear and above only (Fig. 3-13)
 - No more than 3 units must be installed side by side. In addition, leave space as shown.
 - Do not install the optional air outlet guides for upward airflow.
- Obstacles at front only (Fig. 3-14)
- Obstacles at front and rear only (Fig. 3-15)
- Single parallel unit arrangement (Fig. 3-16)
 - * When using an optional air outlet guide installed for upward airflow, the clearance should be 500 mm or more.
- Multiple parallel unit arrangement (Fig. 3-17)
 - * When using an optional air outlet guide installed for upward airflow, the clearance should be 1000 mm or more.
- Stacked unit arrangement (Fig. 3-18)
 - The units can be stacked up to two units high.
 - No more than 2 stacked units must be installed side by side. In addition, leave space as shown.

UNIT : mm

Outdoor unit

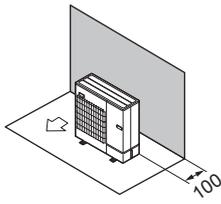

Fig. 3-6

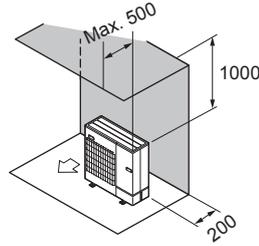

Fig. 3-7

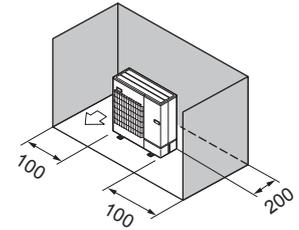

Fig. 3-8

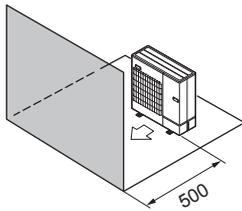

Fig. 3-9

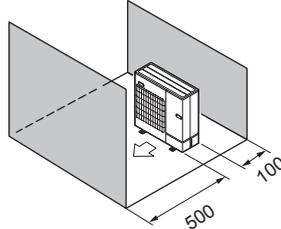

Fig. 3-10

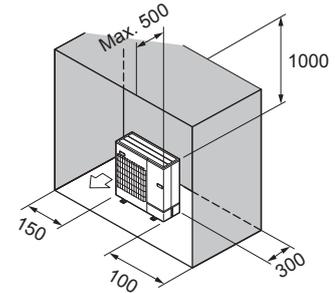

Fig. 3-11

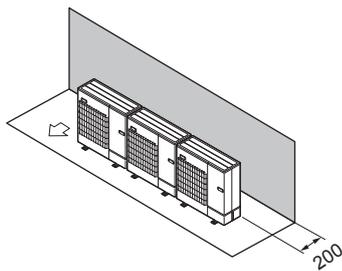

Fig. 3-12

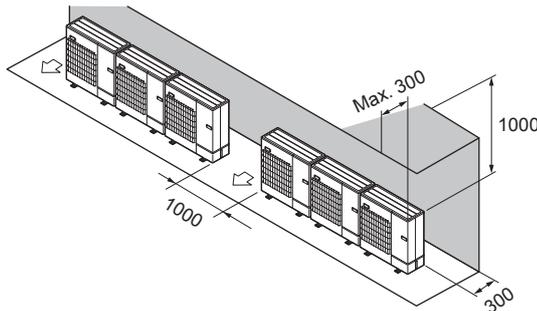

Fig. 3-13

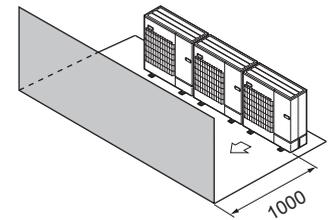

Fig. 3-14

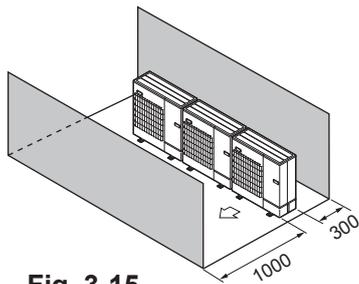

Fig. 3-15

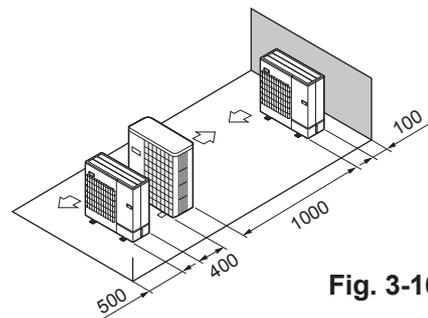

Fig. 3-16

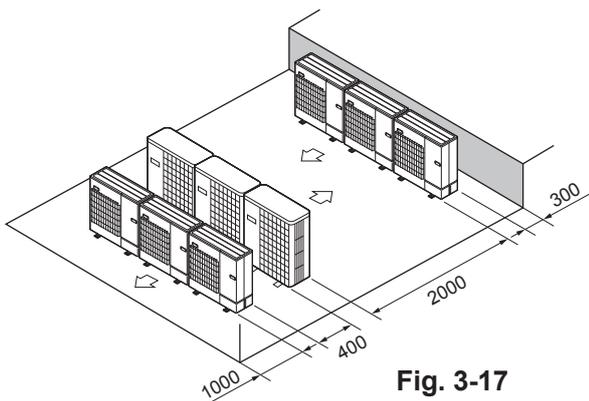

Fig. 3-17

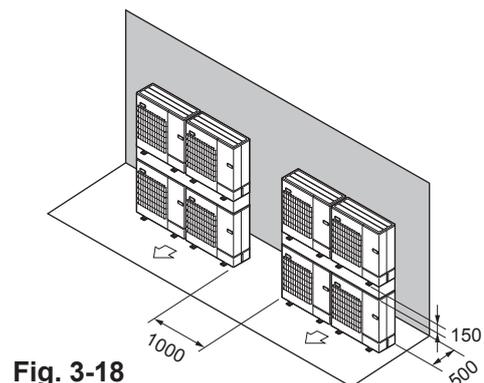

Fig. 3-18

10.4 Split-type units (ZUBADAN)

PUHZ-SHW80VHA(-BS), PUHZ-SHW112VHA(-BS),
 PUHZ-SHW112YHA(-BS), PUHZ-SHW140YHA(-BS),
 PUHZ-SHW230YKA2

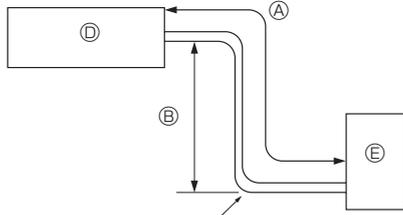

Fig. 4-1

Refrigerant pipe (Fig. 4-1)

Check that the difference between the heights of the indoor and outdoor units, the length of refrigerant pipe, and the number of bends in the pipe are within the limits shown below.

Models	Ⓐ Pipe length (one way)	Ⓑ Height difference	Ⓒ Number of bends (one way)
SHW80,112,140	2 m - 75 m	Max. 30 m	Max. 15
SHW230	2 m - 80 m	Max. 30 m	Max. 15

- Height difference limitations are binding regardless of which unit, indoor or outdoor, is positioned higher.
- ⓐ Indoor unit ⓑ Outdoor unit

Choosing the outdoor unit installation location

- Avoid locations exposed to direct sunlight or other sources of heat.
- Select a location from which noise emitted by the unit will not inconvenience neighbors.
- Select a location permitting easy wiring and pipe access to the power source and indoor unit.
- Avoid locations where combustible gases may leak, be produced, flow, or accumulate.
- Note that water may drain from the unit during operation.
- Select a level location that can bear the weight and vibration of the unit.
- Avoid locations where the unit can be covered by snow. In areas where heavy snow fall is anticipated, special precautions such as raising the installation location or installing a hood on the air intake must be taken to prevent the snow from blocking the air intake or blowing directly against it. This can reduce the airflow and a malfunction may result.
- Avoid locations exposed to oil, steam, or sulfuric gas.
- Use the transportation handles of the outdoor unit to transport the unit. If the unit is carried from the bottom, hands or fingers may be pinched.

Outline dimensions (Outdoor unit) (Fig. 4-2)

Ventilation and service space

(1) Windy location installation

When installing the outdoor unit on a rooftop or other location unprotected from the wind, situate the air outlet of the unit so that it is not directly exposed to strong winds. Strong wind entering the air outlet may impede the normal airflow and a malfunction may result.

The following shows three examples of precautions against strong winds.

- ① Face the air outlet towards the nearest available wall about 50 cm away from the wall. (Fig. 4-3)
- ② Install an optional air guide if the unit is installed in a location where strong winds from a typhoon, etc. may directly enter the air outlet. (Fig. 4-4)
 - Ⓐ Air protection guide
- ③ Position the unit so that the air outlet blows perpendicularly to the seasonal wind direction, if possible. (Fig. 4-5)
 - Ⓑ Wind direction

(2) When installing a single outdoor unit (Refer to the next page)

Minimum dimensions are as follows, except for Max., meaning Maximum dimensions, indicated.

Refer to the figures for each case.

- ① Obstacles at rear only (Fig. 4-6)
- ② Obstacles at rear and above only (Fig. 4-7)
- ③ Obstacles at rear and sides only (Fig. 4-8)
- ④ Obstacles at front only (Fig. 4-9)
 - *When using the optional air outlet guides, the clearance is 500 mm or more.
- ⑤ Obstacles at front and rear only (Fig. 4-10)
 - *When using the optional air outlet guides, the clearance is 500 mm or more.
- ⑥ Obstacles at rear, sides, and above only (Fig. 4-11)
 - *Do not install the optional air outlet guides for upward airflow.

(3) When installing multiple outdoor units (Refer to the next page)

Leave 10 mm space or more between the units.

- ① Obstacles at rear only (Fig. 4-12)
- ② Obstacles at rear and above only (Fig. 4-13)
 - *No more than 3 units must be installed side by side. In addition, leave space as shown.
 - *Do not install the optional air outlet guides for upward airflow.
- ③ Obstacles at front only (Fig. 4-14)
 - *When using the optional air outlet guides, the clearance is 1000 mm or more.
- ④ Obstacles at front and rear only (Fig. 4-15)
 - *When using the optional air outlet guides, the clearance is 1000 mm or more.
- ⑤ Single parallel unit arrangement (Fig. 4-16)
 - *When using the optional air outlet guides installed for upward airflow, the clearance is 1000 mm or more.
- ⑥ Multiple parallel unit arrangement (Fig. 4-17)
 - *When using the optional air outlet guides installed for upward airflow, the clearance is 1500 mm or more.
- ⑦ Stacked unit arrangement (Fig. 4-18)
 - *The units can be stacked up to 2 units high.
 - *No more than 2 stacked units must be installed side by side. In addition, leave space as shown.

SHW80,112,140

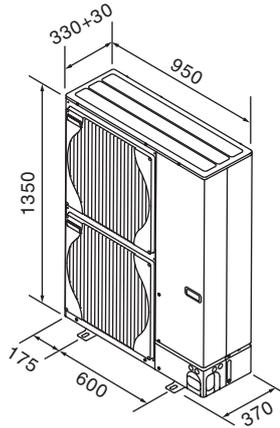

SHW230

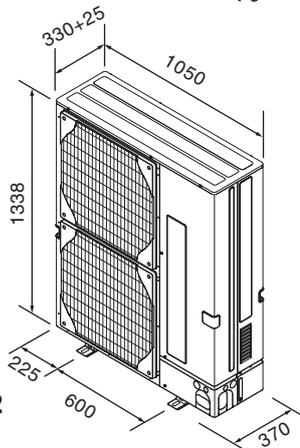

Fig. 4-2

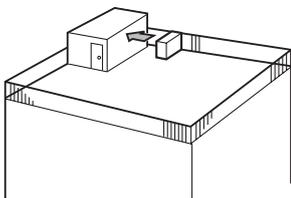

Fig. 4-3

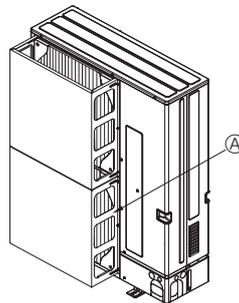

Fig. 4-4

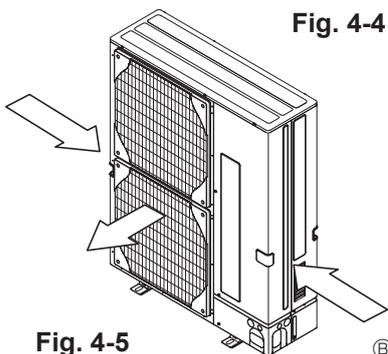

Fig. 4-5

UNIT : mm

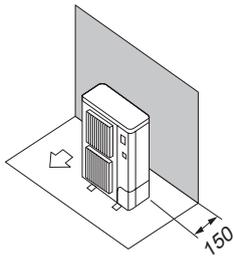

Fig. 4-6

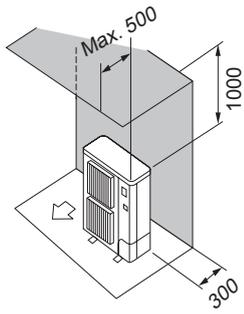

Fig. 4-7

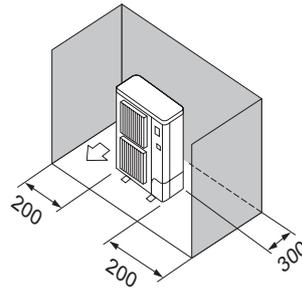

Fig. 4-8

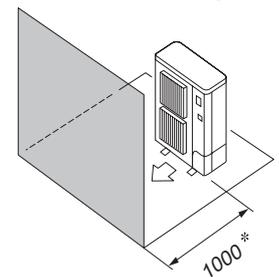

Fig. 4-9

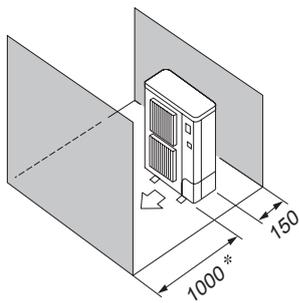

Fig. 4-10

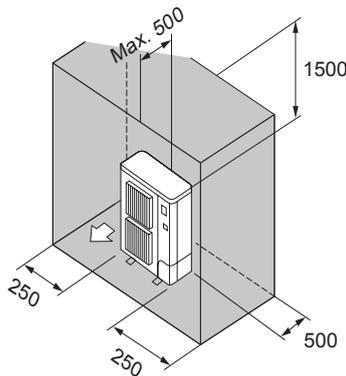

Fig. 4-11

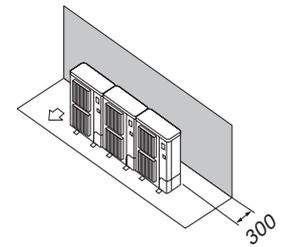

Fig. 4-12

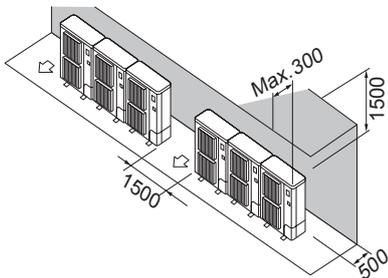

Fig. 4-13

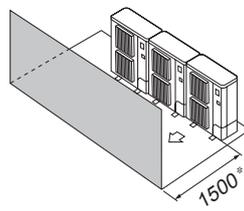

Fig. 4-14

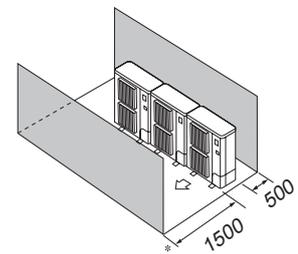

Fig. 4-15

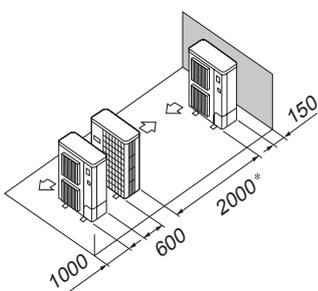

Fig. 4-16

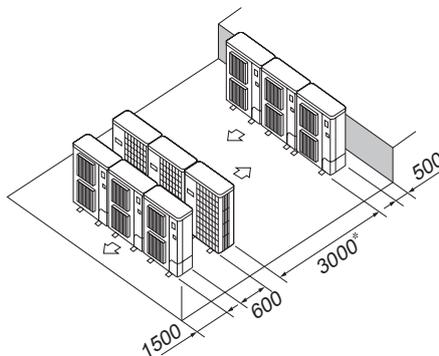

Fig. 4-17

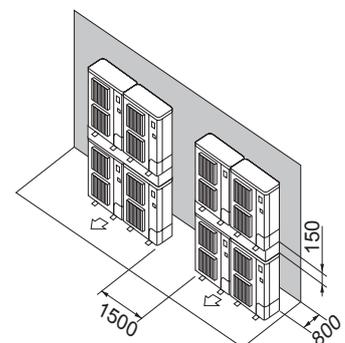

Fig. 4-18

PUHZ-SHW80/112VAA(-BS), PUHZ-SHW80/112YAA(-BS)

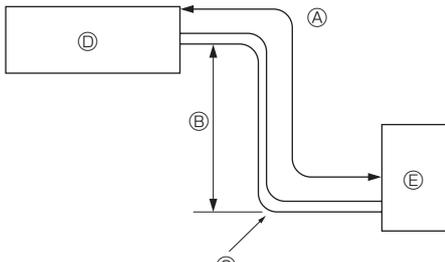

Fig. 4-19

(mm)

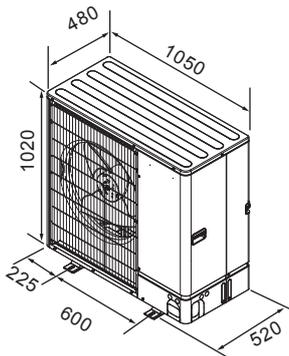

Fig. 4-20

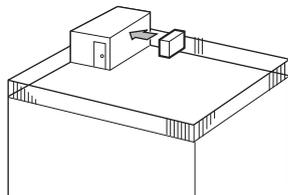

Fig. 4-21

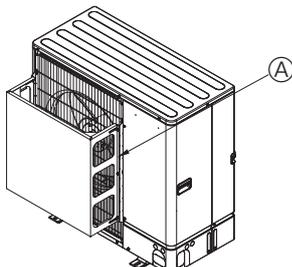

Fig. 4-22

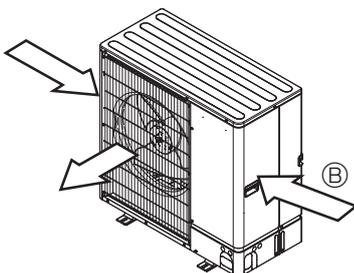

Fig. 4-23

Refrigerant pipe (Fig. 4-19)

- ▶ Check that the difference between the heights of the indoor and outdoor units, the length of refrigerant pipe, and the number of bends in the pipe are within the limits shown below.

Model	Ⓐ Pipe length (one way)	Ⓑ Height difference	Ⓒ Number of bends (one way)
SHW80, 112	2 m - 75 m	Max. 30 m	Max. 15

- Height difference limitation is defined regardless of which unit, indoor or outdoor, is positioned higher.

- Ⓓ Indoor unit
- Ⓔ Outdoor unit

Choosing the outdoor unit installation location

- Avoid locations exposed to direct sunlight or other sources of heat.
- Select a location from which noise emitted by the unit will not inconvenience neighbors.
- Select a location permitting easy wiring and pipe access to the power source and indoor unit.
- Avoid locations where combustible gases may leak, be produced, flow, or accumulate.
- Note that water may drain from the unit during operation.
- Select a level location that can bear the weight and vibration of the unit.
- Avoid locations where the unit can be covered by snow. In areas where heavy snow fall is anticipated, special precautions such as raising the installation location or installing a hood on the air intake must be taken to prevent the snow from blocking the air intake or blowing directly against it. This can reduce the airflow and a malfunction may result.
- Avoid locations exposed to oil, steam, or sulfuric gas.
- Use the transportation handles of the outdoor unit to transport the unit. If the unit is carried from the bottom, hands or fingers may be pinched.

Outline dimensions (Outdoor unit) (Fig. 4-20)

Ventilation and service space

(1) Windy location installation

When installing the outdoor unit on a rooftop or other location unprotected from the wind, situate the air outlet of the unit so that it is not directly exposed to strong winds. Strong wind entering the air outlet may impede the normal airflow and a malfunction may result.

The following shows three examples of precautions against strong winds.

- ① Face the air outlet towards the nearest available wall about 35 cm away from the wall. (Fig. 4-21)
- ② Install an optional air guide if the unit is installed in a location where strong winds from a typhoon, etc. may directly enter the air outlet. (Fig. 4-22)
 - Ⓐ Air outlet guide
- ③ Position the unit so that the air outlet blows perpendicularly to the seasonal wind direction, if possible. (Fig. 4-23)
 - Ⓑ Wind direction

(2) When installing a single outdoor unit (Refer to the next page)

Minimum dimensions are as follows, except for Max., meaning Maximum dimensions, indicated. Refer to the figures for each case.

- ① Obstacles at rear only (Fig. 4-24)
- ② Obstacles at rear and above only (Fig. 4-25)
 - Do not install the optional air outlet guides for upward airflow.
- ③ Obstacles at rear and sides only (Fig. 4-26)
- ④ Obstacles at front only (Fig. 4-27)
- ⑤ Obstacles at front and rear only (Fig. 4-28)
- ⑥ Obstacles at rear, sides, and above only (Fig. 4-29)
 - Do not install the optional air outlet guides for upward airflow.

(3) When installing multiple outdoor units (Refer to the next page)

Leave 50 mm space or more between the units.

Refer to the figures for each case.

- ① Obstacles at rear only (Fig. 4-30)
- ② Obstacles at rear and above only (Fig. 4-31)
 - No more than 3 units must be installed side by side. In addition, leave space as shown.
 - Do not install the optional air outlet guides for upward airflow.
- ③ Obstacles at front only (Fig. 4-32)
- ④ Obstacles at front and rear only (Fig. 4-33)
- ⑤ Single parallel unit arrangement (Fig. 4-34)
 - * When using an optional air outlet guide installed for upward airflow, the clearance is 500 mm or more.
- ⑥ Multiple parallel unit arrangement (Fig. 4-35)
 - * When using an optional air outlet guide installed for upward airflow, the clearance is 1000 mm or more.
- ⑦ Stacked unit arrangement (Fig. 4-36)
 - The units can be stacked up to two units high.
 - No more than 2 stacked units must be installed side by side. In addition, leave space as shown.

UNIT : mm

Outdoor unit

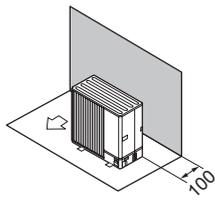

Fig. 4-24

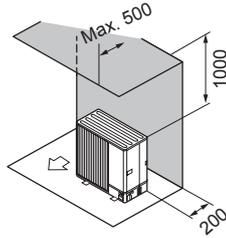

Fig. 4-25

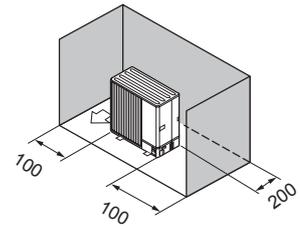

Fig. 4-26

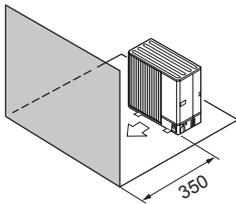

Fig. 4-27

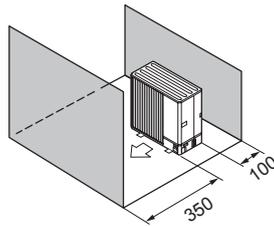

Fig. 4-28

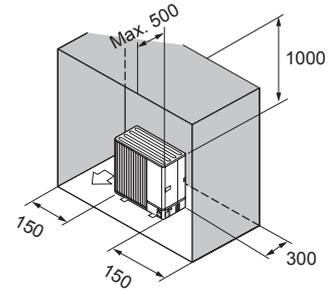

Fig. 4-29

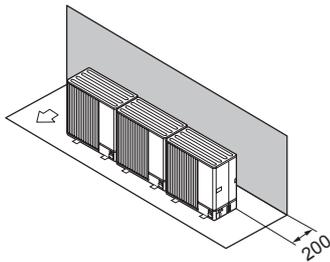

Fig. 4-30

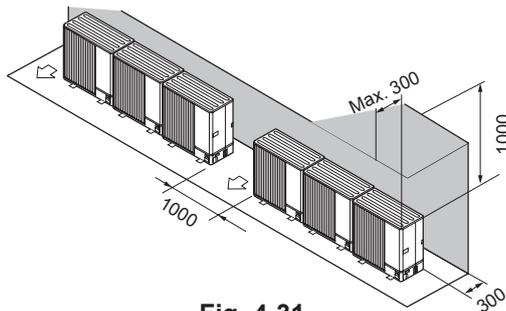

Fig. 4-31

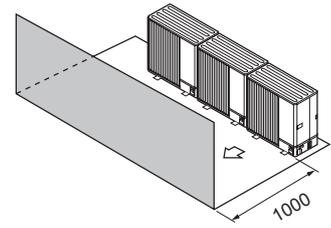

Fig. 4-32

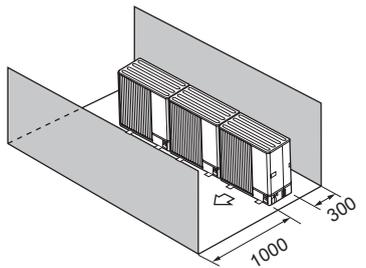

Fig. 4-33

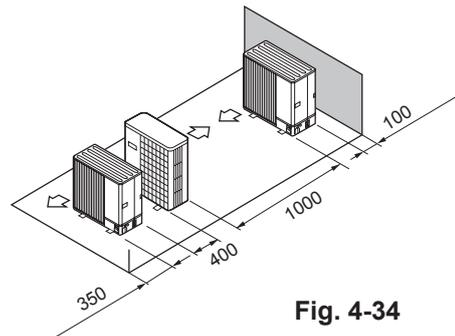

Fig. 4-34

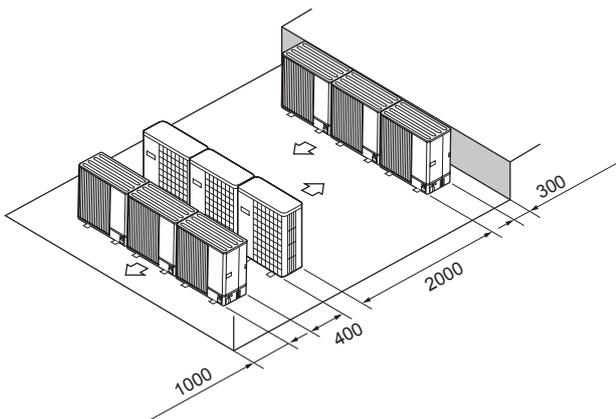

Fig. 4-35

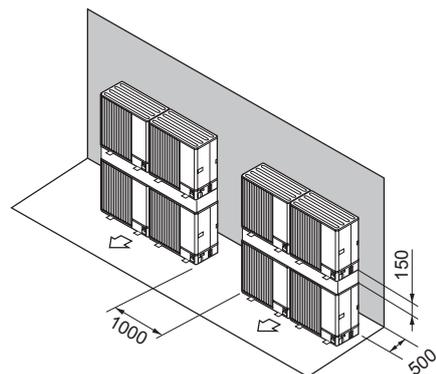

Fig. 4-36

10.5 Split-type units (Inverter Multi)

PUMY-P112/125/140VKM4(-BS)
 PUMY-P112/125/140YKM4(-BS)
 PUMY-P112/125/140YKME4(-BS)

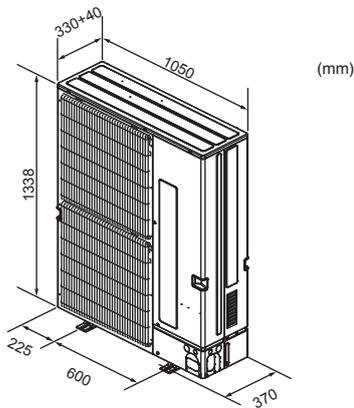

Fig. 5-1

Table 2 Connectable indoor units quantities

• City Multi indoor units

P112	1-9 *1
P125	1-10 *2
P140	1-12 *3

*1 When connecting M series indoor units via Connection kit, 10 indoor units can be connected.

*2 When connecting M series indoor units via Connection kit, 12 indoor units can be connected.

*3 When all the indoor units are P15 models, 12 indoor units can be connected.

• Branch Box system (M, S, P series indoor units via Branch box)

P112	2-8
P125	2-8
P140	2-8

• Mixed system (City Multi indoor units and M, S, P series indoor units via Branch box)

	One Branch box		Two Branch boxes	
	Via Branch box	City Multi indoor	Via Branch box	City Multi indoor
P112	Max. 5	Max. 5*1	Max. 7	Max. 3*1
			Max. 8	Max. 2*1
P125	Max. 5	Max. 5*1	Max. 8	Max. 3*1
P140	Max. 5	Max. 5*1	Max. 8	Max. 3*1

1 PKFY-P.VBM, PFFY-P.VKM, and PFFY-P.VL type indoor units cannot be used in a mixed system.

Refrigerant pipe

Refer to Fig. 5-16 and Fig. 5-17(a)(b).

Choosing the outdoor unit installation location

- Avoid locations exposed to direct sunlight or other sources of heat.
- Select a location from which noise emitted by the unit will not inconvenience neighbors.
- Select a location permitting easy wiring and pipe access to the power source and indoor unit.
- Avoid locations where combustible gases may leak, be produced, flow, or accumulate.
- Note that water may drain from the unit during operation.
- Select a level location that can bear the weight and vibration of the unit.
- Avoid locations where the unit can be covered by snow. In areas where heavy snow fall is anticipated, special precautions such as raising the installation location or installing a hood on the air intake must be taken to prevent the snow from blocking the air intake or blowing directly against it. This can reduce the airflow and a malfunction may result.
- Avoid locations exposed to oil, steam, or sulfuric gas.
- Use the transportation handles of the outdoor unit to transport the unit. If the unit is carried from the bottom, hands or fingers may be pinched.

Outline dimensions (Outdoor unit) (Fig. 5-1)

Constraints on indoor unit installation

You should note that indoor units that can be connected to this outdoor unit are the following models.

- Indoor units with model numbers 15-140 can be connected.

When using Branch box, Indoor units with model numbers 15-100 can be connected. Refer to the table 1 below for possible room, indoor unit combinations.

Verification

The rated capacity should be determined by observing the table below. The unit's quantities are limited as shown in the following table 2. For the next step, make sure that the total rated capacity selected will stay in a range of 50% – 130% of the outdoor unit capacity.

- PUMY-P112 6.3 – 16.2 kW
- PUMY-P125 7.1 – 18.2 kW
- PUMY-P140 8.0 – 20.2 kW

Table 1-1 City Multi indoor units (P-FY series)

Indoor unit type	P15*	P20	P25	P32	P40	P50	P63	P71	P80	P100	P125	P140
Rated capacity (Cooling) (kW)	1.7	2.2	2.8	3.6	4.5	5.6	7.1	8.0	9.0	11.2	14.0	16.0

Table 1-2 (M series, P series, S series)

Indoor unit type	15	20	22	25	35	42	50	60	71	80	100
Rated capacity (Cooling) (kW)	1.5	2.0	2.2	2.5	3.5	4.2	5.0	6.0	7.1	8.0	10.0

Combinations in which the total capacity of indoor units exceeds the capacity of the outdoor unit will reduce the cooling capacity of each indoor unit below their rated cooling capacity. Thus, combine indoor units with an outdoor unit within the outdoor unit's capacity, if possible.

* When all the indoor units are P15 models, 12 indoor units can be connected to 1 outdoor unit.

■ Connecting a Cylinder (EHST20C) or Hydrobox (EHSC) unit

When connecting a Cylinder or Hydrobox unit, be aware of the following points because the Cylinder and Hydrobox unit are different from other indoor units.

(1) Connection restrictions

- Only 1 Cylinder (EHST20C) or 1 Hydrobox (EHSC) unit can be connected. (EHST20C-MEC, EHST20D series, EHPT20X series, EHSD series, EHSC-MEC, ERSD series, ERSC series and EHPX series cannot be connected.)
 - When connecting Ecodan systems, use a PAC-MK32/33/52/53BC(B) branch box. (A PAC-MK31/51BC(B) branch box cannot be used.)
 - PWFY units cannot be connected at the same time as a Cylinder or Hydrobox unit.
 - ATA indoor units*1 with a total rated capacity of 50% – 130% of the outdoor unit capacity and 1 Cylinder or 1 Hydrobox unit can be connected.
- *1 ATA indoor unit: An indoor unit excluding a PWFY, Cylinder unit, and Hydrobox unit.
- PUMY-P112 1 Cylinder or 1 Hydrobox + ATA indoor units [max 16.2 (1.3*2) kW]
 - PUMY-P125 1 Cylinder or 1 Hydrobox + ATA indoor units [max 18.2 (2.8*2) kW]
 - PUMY-P140 1 Cylinder or 1 Hydrobox + ATA indoor units [max 20.2 (4.3*2) kW]
- *2 In case of the operating a Cylinder or Hydrobox unit in Heating mode / DHW mode and operating ATA indoor units at the same time. However, the following combinations can be connected.
- PUMY-P112: MSZ-SF15VA or MSZ-AP15VF × 1
 - PUMY-P125: MSZ-SF15VA or MSZ-AP15VF × 2
 - PUMY-P140: MSZ-SF15VA or MSZ-AP15VF × 3

(2) Indoor unit specifications

When connecting a Cylinder or a Hydrobox unit, the following specifications will change.

- The Cylinder or Hydrobox unit cannot operate in cooling mode.
- The operation mode of the Cylinder or Hydrobox unit always has priority.
- The DHW operation eco mode cannot be used.
- Maximum flow temperature is 55°C. (Dip SW1-2 on the Cylinder or Hydrobox unit must be changed to OFF.)
- Energy monitoring can be used only when an external power meter is connected.
- Multiple outdoor units cannot be controlled.
- A Cylinder or Hydrobox unit cannot be connected to an M-NET remote controller and a centralized controller.
- Boiler interlock can be used only when switching to the outside air temperature.
- A Cylinder or Hydrobox unit cannot be grouped with an ATA indoor unit.
- In case of the operating a Cylinder or Hydrobox unit in the **Heating mode** and operating ATA indoor units at the same time, be aware of the following points.
 - Heating flow temperature range of Cylinder or Hydrobox unit is 45°C - 55°C.
 - Please set the flow temperature range in reference to the Cylinder or Hydrobox installation Manual.
 - The outdoor temperature must be -10°C or more. When the outdoor temperature is less than 7°C, the flow temperature and blow off temperature are lowered.
- When operating a Cylinder or Hydrobox unit in the **DHW mode** and operating ATA indoor units at the same time, the outdoor temperature must be 7°C or more. When the outdoor temperature is less than 7°C, they cannot operate at the same time.

(3) Switch settings

When connecting a Cylinder or Hydrobox unit to a PUMY unit, set the DIP switch SW1-2 on Cylinder or Hydrobox unit to OFF.

(4) Test run

Perform the test run for the Cylinder or Hydrobox unit from the indoor unit.

(For details about the test run, refer to the installation manual for the Cylinder or Hydrobox unit.)

(5) Refrigerant collecting (Pump down)

Perform the procedures below.

■ Refrigerant collecting (Pump down)

Perform the following procedures to collect the refrigerant when moving the indoor unit or the outdoor unit.

- 1 Turn off the circuit breaker.
- 2 Connect the low pressure side of the gauge manifold to the service port of the gas side stop valve.
- 3 Close the liquid stop valve.
- 4 Supply power (circuit breaker).
 - * Start-up of the indoor-outdoor communication takes about 3 minutes after the power (circuit breaker) is turned on. Start the pump-down operation 3 to 4 minutes after the power (circuit breaker) is turned ON.
- 5 Operate all of the indoor units, excluding a Cylinder or Hydrobox unit, in cooling mode.
- 6 Fully close the gas stop valve when the pressure reading on the gauge drops 0.05 - 0.00 MPa (approximately 0.5 - 0.0 kgf/cm²)
- 7 Stop the air conditioner operation.
- 8 Turn off the power supply (circuit breaker).
 - * If too much refrigerant has been added to the air conditioner system, the pressure may not drop to 0.05 MPa (0.5 kgf/cm²). If this occurs, use a refrigerant collecting device to collect all of the refrigerant in the system, and then recharge the system with the correct amount of refrigerant after the indoor and outdoor units have been relocated.

⚠ Warning:

When pumping down the refrigerant, stop the compressor before disconnecting the refrigerant pipes. The compressor may burst and cause injury if any foreign substance, such as air, enters the system.

■ Ventilation and service space

(1) When installing a single outdoor unit

Minimum dimensions are as follows, except for Max., meaning Maximum dimensions, indicated.

Refer to the figures for each case.

- ① Obstacles at rear only (Fig. 5-3)
- ② Obstacles at rear and above only (Fig. 5-4)
 - Do not install the optional air outlet guides for upward airflow.
- ③ Obstacles at rear and sides only (Fig. 5-5)
- ④ Obstacles at front only (Fig. 5-6)
 - * When using an optional air outlet guide, the clearance is 500 mm or more.
- ⑤ Obstacles at front and rear only (Fig. 5-7)
 - * When using an optional air outlet guide, the clearance is 500 mm or more.
- ⑥ Obstacles at rear, sides, and above only (Fig. 5-8)
 - Do not install the optional air outlet guides for upward airflow.

(2) When installing multiple outdoor units

Leave 25 mm space or more between the units.

- ① Obstacles at rear only (Fig. 5-9)
- ② Obstacles at rear and above only (Fig. 5-10)
 - No more than three units must be installed side by side. In addition, leave space as shown.
 - Do not install the optional air outlet guides for upward airflow.
- ③ Obstacles at front only (Fig. 5-11)
 - * When using an optional air outlet guide, the clearance is 1000 mm or more.
- ④ Obstacles at front and rear only (Fig. 5-12)
 - * When using an optional air outlet guide, the clearance is 1000 mm or more.
- ⑤ Single parallel unit arrangement (Fig. 5-13)
 - * When using an optional air outlet guide installed for upward airflow, the clearance is 1000 mm or more.
- ⑥ Multiple parallel unit arrangement (Fig. 5-14)
 - * When using an optional air outlet guide installed for upward airflow, the clearance is 1500 mm or more.
- ⑦ Stacked unit arrangement (Fig. 5-15)
 - The units can be stacked up to two units high.
 - No more than two stacked units must be installed side by side. In addition, leave space as shown.

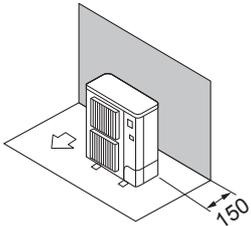

Fig. 5-3

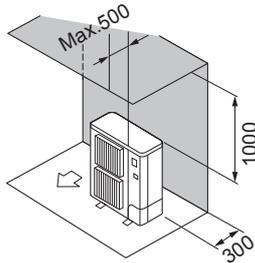

Fig. 5-4

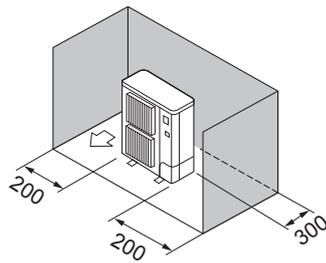

Fig. 5-5

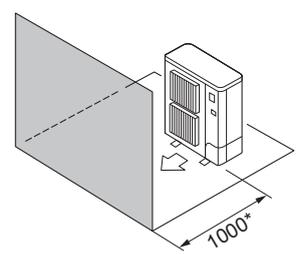

Fig. 5-6

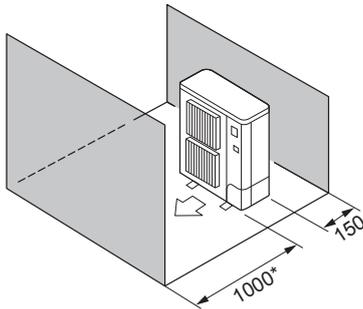

Fig. 5-7

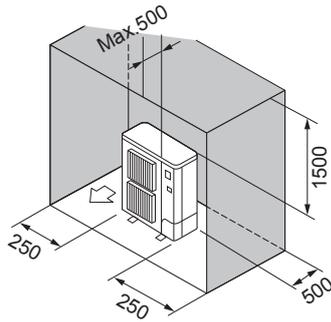

Fig. 5-8

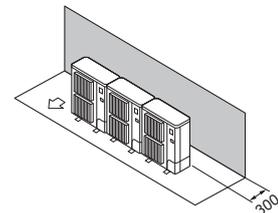

Fig. 5-9

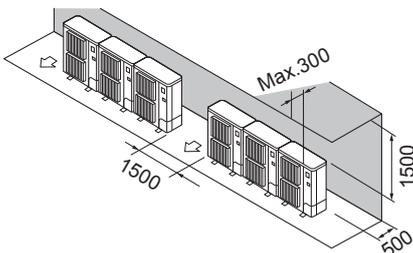

Fig. 5-10

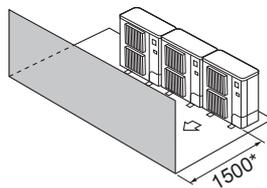

Fig. 5-11

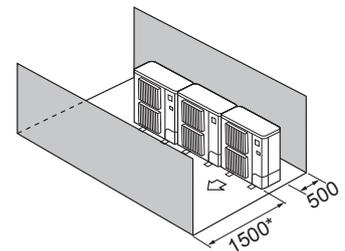

Fig. 5-12

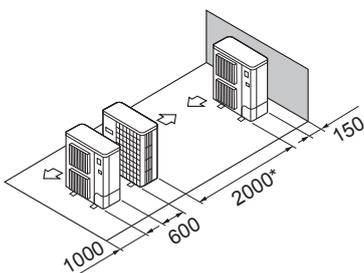

Fig. 5-13

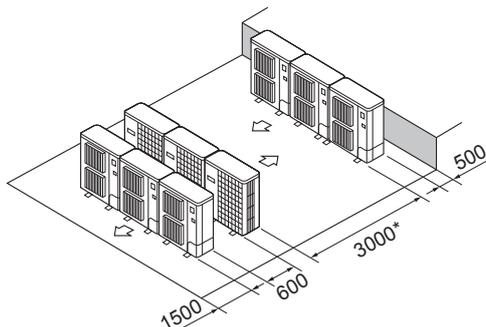

Fig. 5-14

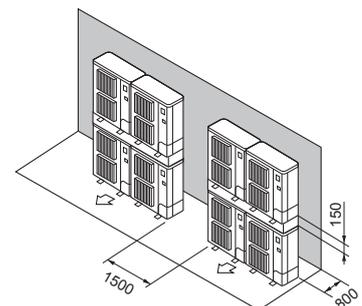

Fig. 5-15

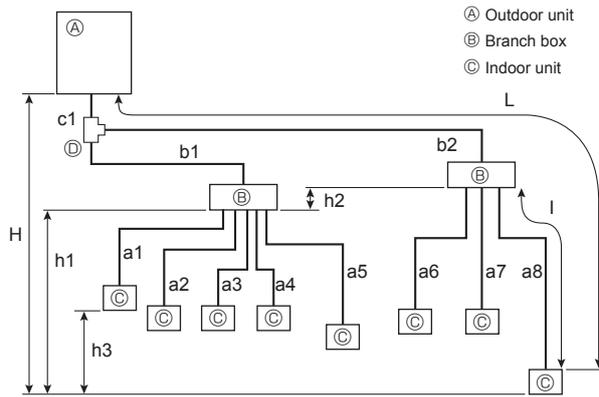

Fig. 5-16

■ Pipe length and height difference

(1) Connection with Branch Box (Fig. 5-16)

- This unit has flared connections on each indoor unit and branch box and outdoor unit sides.
- Remove the valve cover of the outdoor unit, then connect the pipe.
- Refrigerant pipes are used to connect the branch box and outdoor unit.

Permissible length (one-way)	Total piping length	$c1 + b1 + b2 + a1 + a2 + a3 + a4 + a5 + a6 + a7 + a8 \leq 150 \text{ m}$
	Farthest piping length (L)	$c1 + b2 + a8 \leq 80 \text{ m}$
	Piping length between outdoor unit and branch boxes	$c1 + b1 + b2 \leq 55 \text{ m}$
	Farthest branch box from the first joint (b2)	$b2 \leq 30 \text{ m}$
	Farthest piping length after branch box (l)	$a8 \leq 25 \text{ m}$
	Total piping length between branch boxes and indoor units	$a1 + a2 + a3 + a4 + a5 + a6 + a7 + a8 \leq 95 \text{ m}$
Permissible height difference (one-way)	In indoor/outdoor section (H)*1	$H \leq 50 \text{ m}$ (In case of outdoor unit is set higher than indoor unit) $H \leq 40 \text{ m}$ (In case of outdoor unit is set lower than indoor unit)
	In branch box/indoor unit section (h1)	$h1 + h2 \leq 15 \text{ m}$
	In each branch unit (h2)	$h2 \leq 15 \text{ m}$
	In each indoor unit (h3)	$h3 \leq 12 \text{ m}$
Number of bends	$ c1 + b1 + a1 , c1 + b1 + a2 , c1 + b1 + a3 , c1 + b1 + a4 , c1 + b1 + a5 ,$ $ c1 + b2 + a6 , c1 + b2 + a7 , c1 + b2 + a8 \leq 15$	

*1 Branch box should be placed within the level between the outdoor unit and indoor units.

(2) Mixed system (City Multi indoor units and M/S/P series indoor units via Branch box) (Fig. 5-17)

1. In case of using 1-Branch boxes

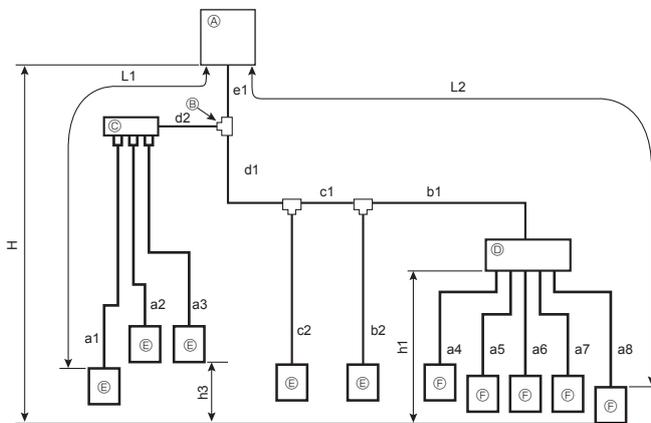

Fig. 5-17 (a)

- Ⓐ Outdoor Unit
- Ⓑ First joint
- Ⓒ Branch header (CMY)
- Ⓓ Branch box
- Ⓔ CityMulti Indoor unit
- Ⓕ M/S/P series Indoor unit, Cylinder unit or Hydrobox unit

Permissible length (One-way)	Total piping length	$e1 + d1 + d2 + c1 + c2 + b1 + b2 + a1 + a2 + a3 + a4 + a5 + a6 + a7 + a8 \leq 300 \text{ m}^*3$
	Farthest piping length (L1)	$e1 + d2 + a1$ or $e1 + d1 + c1 + b2 \leq 85 \text{ m}$
	Farthest piping length. Via Branch box (L2)	$e1 + d1 + c1 + b1 + a8 \leq 80 \text{ m}$
	Piping length between outdoor unit and branch box	$e1 + d1 + c1 + b1 \leq 55 \text{ m}$
	Farthest piping length from the first joint	$d1 + c1 + b1, d1 + c1 + b2, d1 + c2$ or $d2 + c1 \leq 30 \text{ m}$
	Farthest piping length after branch box	$a8 \leq 25 \text{ m}$
	Total piping length between branch boxes and indoor units	$a4 + a5 + a6 + a7 + a8 \leq 95 \text{ m}$
Permissible height difference (One-way)	In indoor/outdoor section (H) *2	$H \leq 50 \text{ m}$ (In case of outdoor unit is set higher than indoor unit) $H \leq 40 \text{ m}$ (In case of outdoor unit is set lower than indoor unit)
	In branch box/indoor unit section (h1)	$h1 \leq 15 \text{ m}$
	In each indoor unit (h3)	$h3 \leq 12 \text{ m}$
Number of bends	$ e1 + d2 + a1 , e1 + d2 + a2 , e1 + d2 + a3 , e1 + d1 + c2 , e1 + d1 + c1 + b2 ,$ $ e1 + d1 + c1 + b1 + a4 , e1 + d1 + c1 + b1 + a5 , e1 + d1 + c1 + b1 + a6 ,$ $ e1 + d1 + c1 + b1 + a7 , e1 + d1 + c1 + b1 + a8 \leq 15$	

*2: Branch box should be placed within the level between the outdoor unit and indoor units.

*3: When a Cylinder unit or Hydrobox unit is connected, the maximum piping length is 150 m.

2. In case of using 2-Branch boxes

Outdoor unit

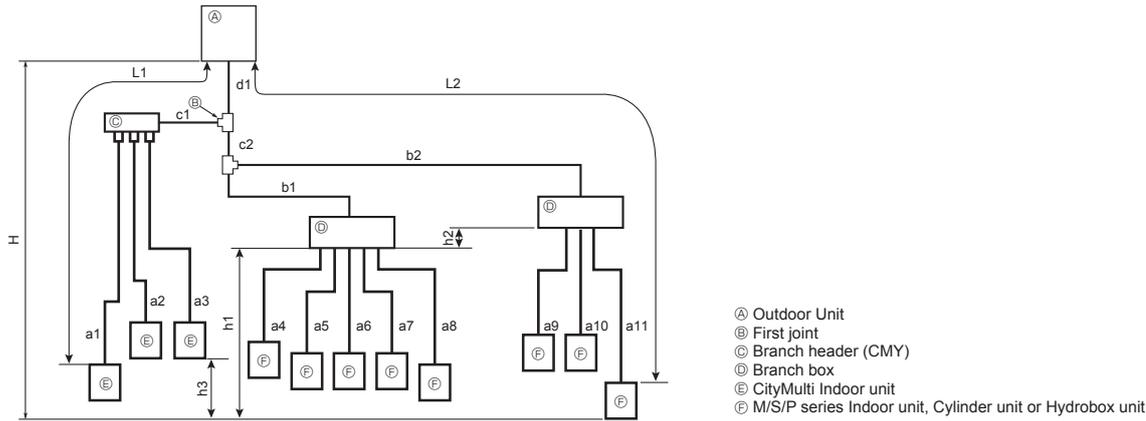

Fig. 5-17 (b)

Permissible length (One-way)	Total piping length	$d1 + c1 + c2 + b1 + b2 + a1 + a2 + a3 + a4 + a5 + a6 + a7 + a8 + a9 + a10 + a11 \leq 240 \text{ m} *3$
	Farthest piping length (L1)	$d1 + c1 + a1 \leq 85 \text{ m}$
	Farthest piping length. Via Branch box (L2)	$d1 + c2 + b2 + a11 \leq 80 \text{ m}$
	Piping length between outdoor unit and branch boxes	$d1 + c2 + b1 + b2 \leq 55 \text{ m}$
	Farthest piping length from the first joint	$c2 + b2 \text{ or } c1 + a1 \leq 30 \text{ m}$
	Farthest piping length after branch box	$a11 \leq 25 \text{ m}$
	Farthest branch box from outdoor unit	$d1 + c2 + b2 \leq 55 \text{ m}$
	Total piping length between branch boxes and indoor units	$a4 + a5 + a6 + a7 + a8 + a9 + a10 + a11 \leq 95 \text{ m}$
Permissible height difference (One-way)	In indoor/outdoor section (H) *2	$H \leq 50 \text{ m}$ (In case of outdoor unit is set higher than indoor unit) $H \leq 40 \text{ m}$ (In case of outdoor unit is set lower than indoor unit)
	In branch box/indoor unit section (h1+h2)	$h1 + h2 \leq 15 \text{ m}$
	In each branch unit (h1)	$h2 \leq 15 \text{ m}$
	In each indoor unit (h3)	$h3 \leq 12 \text{ m}$
Number of bends		$ d1 + c1 + a1 , d1 + c1 + a2 , d1 + c1 + a3 , d1 + c2 + b1 + a4 , d1 + c2 + b1 + a5 , d1 + c2 + b1 + a6 , d1 + c2 + b1 + a7 , d1 + c2 + b1 + a8 , d1 + c2 + b2 + a9 , d1 + c2 + b2 + a10 , d1 + c2 + b2 + a11 \leq 15$

*2: Branch box should be placed within the level between the outdoor unit and indoor units.

*3: When a Cylinder unit or Hydrobox unit is connected, the maximum piping length is 150 m.

1	Specifications	B-2
1.1	Combination table	B-2
1.2	Cylinder unit	B-4
1.3	Hydrobox.....	B-8
2	Outlines and dimensions	B-12
2.1	Cylinder unit	B-12
2.2	Hydrobox.....	B-13
2.3	System configuration	B-15
2.4	Service access diagrams	B-15
3	Wiring diagrams.....	B-16
3.1	Cylinder unit.....	B-16
3.2	Hydrobox.....	B-29
3.3	Using SD memory card.....	B-46
3.4	Caution on connecting DHW tank(Hydrobox).....	B-47
3.5	Wiring for 2-zone temperature control	B-49
4	Water circuit diagrams	B-50
4.1	Water quality and system preparation.....	B-56
4.2	Water pipe work.....	B-56
4.3	Performance curve external pressure.....	B-59
4.4	Safety device discharge arrangements for UK(G3)	B-61
5	Performance data	B-63
5.1	Combination Performance	B-63
5.2	Heat time data (DHW mode).....	B-68
6	Noise criterion curves	B-75
7	System Set Up.....	B-76
8	Troubleshooting.....	B-91
8.1	Cylinder unit	B-91
8.2	Hydrobox.....	B-100
9	Supplementary information	B-111

1.1 Combination table

MODELS		POWER INVERTER							ZUBADAN			POWER INVERTER										Mr.SLIM+			
TYPE		PACKAGE										SPLIT													
REFRIGERANT		Heat pump																							
REFRIGERANT		R410A																							
TYPE	Model name	PUHZ-W60VHA2	PUHZ-W65VHA2	PUHZ-W112VHA	PUHZ-W65VAA	PUHZ-W65YAA	PUHZ-W112VAA	PUHZ-W112YAA	PUHZ-HW112YHA2	PUHZ-HW140VHA2	PUHZ-HW140YHA2	SUHZ-SW45VA(H)	PUHZ-SW60VKA	PUHZ-SW75VHA	PUHZ-SW100VHA	PUHZ-SW100YHA	PUHZ-SW120VHA	PUHZ-SW120YHA	PUHZ-SW160YKA	PUHZ-SW200YKA	PUHZ-SW75VAA	PUHZ-SW75YAA	PUHZ-SW100VAA	PUHZ-SW100YAA	PUHZ-FRP71VHA2
CYLINDER	EHST20C-VM2C													●	●	●	●	●					●	●	●
	EHST20C-VM6C													●	●	●	●	●					●	●	●
	EHST20C-YM9C													●	●	●	●	●					●	●	●
	EHST20C-TM9C													●	●	●	●	●					●	●	●
	EHST20C-VM2EC													●	●	●	●	●					●	●	●
	EHST20C-VM6EC													●	●	●	●	●					●	●	●
	EHST20C-YM9EC													●	●	●	●	●					●	●	●
	EHST20C-MEC													●	●	●	●	●					●	●	●
	EHST20C-MHCW													●	●	●	●	●					●	●	●
	EHST20D-VM2C											●	●	●								●	●		
	EHST20D-MEC											●	●	●								●	●		
	EHST20D-MHC											●	●	●								●	●		
	EHST20D-MHCW											●	●	●								●	●		
	EHST20D-VM2EC											●	●	●								●	●		
	EHST20D-YM9C											●	●	●								●	●		
	ERST20C-MEC													●	●	●	●	●					●	●	
	ERST20C-VM2C													●	●	●	●	●					●	●	
	ERST20D-MEC											●	●	●								●	●		
	ERST20D-VM2C											●	●	●								●	●		
	EHPT20X-VM2C	●	●	●	●	●	●	●	●	●	●														
EHPT20X-VM6C	●	●	●	●	●	●	●	●	●	●															
EHPT20X-YM9C	●	●	●	●	●	●	●	●	●	●															
EHPT20X-TM9C	●	●	●	●	●	●	●	●	●	●															
EHPT20X-MHCW	●	●	●	●	●	●	●	●	●	●															
HYDROBOX	EHSC-VM2C												●	●	●	●	●					●	●	●	
	EHSC-VM2EC												●	●	●	●	●					●	●	●	
	EHSC-VM6C												●	●	●	●	●					●	●	●	
	EHSC-VM6EC												●	●	●	●	●					●	●	●	
	EHSC-YM9C												●	●	●	●	●					●	●	●	
	EHSC-YM9EC												●	●	●	●	●					●	●	●	
	EHSC-TM9C												●	●	●	●	●					●	●	●	
	EHSC-MEC												●	●	●	●	●					●	●	●	
	EHSD-VM2C											●	●	●								●	●		
	EHSD-YM9C											●	●	●								●	●		
	EHSD-MEC											●	●	●								●	●		
	EHSD-MC											●	●	●								●	●		
	ERSC-VM2C												●	●	●	●	●						●	●	
	ERSC-MEC												●	●	●	●	●						●	●	
	ERSD-VM2C											●	●	●								●	●		
	EHPX-VM2C	●	●	●	●	●	●	●	●	●	●														
	EHPX-VM6C	●	●	●	●	●	●	●	●	●	●														
	EHPX-YM9C	●	●	●	●	●	●	●	●	●	●														
	EHSE-YM9EC																			●	●				
	EHSE-MEC																			●	●				
ERSE-YM9EC																			●	●					
ERSE-MEC																			●	●					

● : Combination is available.

Blank: Combination is NOT available.

MODEL		ZUBADAN								INVERTER MULTI								
TYPE		SPLIT																
		Heat pump																
REFRIGERANT		R410A																
TYPE	Model name	PUHZ-SHW80VHA	PUHZ-SHW112VHA	PUHZ-SHW112YHA	PUHZ-SHW140YHA	PUHZ-SHW230YKA2	PUHZ-SHW80VAA	PUHZ-SHW80YAA	PUHZ-SHW112VAA	PUHZ-SHW112YAA	PUMY-P112YKM4	PUMY-P112YKM4	PUMY-P112YKME4	PUMY-P125YKM4	PUMY-P125YKM4	PUMY-P125YKME4	PUMY-P140YKM4	PUMY-P140YKME4
CYLINDER	EHST20C-VM2C	●	●	●	●		●	●	●	●	●	●	●	●	●	●	●	●
	EHST20C-VM6C	●	●	●	●		●	●	●	●	●	●	●	●	●	●	●	●
	EHST20C-YM9C	●	●	●	●		●	●	●	●	●	●	●	●	●	●	●	●
	EHST20C-TM9C	●	●	●	●		●	●	●	●	●	●	●	●	●	●	●	●
	EHST20C-VM2EC	●	●	●	●		●	●	●	●	●	●	●	●	●	●	●	●
	EHST20C-VM6EC	●	●	●	●		●	●	●	●	●	●	●	●	●	●	●	●
	EHST20C-YM9EC	●	●	●	●		●	●	●	●	●	●	●	●	●	●	●	●
	EHST20C-MEC	●	●	●	●		●	●	●	●								
	EHST20C-MHCW	●	●	●	●		●	●	●	●	●	●	●	●	●	●	●	●
	EHST20D-VM2C																	
	EHST20D-MEC																	
	EHST20D-MHC																	
	EHST20D-MHCW																	
	EHST20D-VM2EC																	
	EHST20D-YM9C																	
	ERST20C-MEC	●	●	●	●		●	●	●	●								
	ERST20C-VM2C	●	●	●	●		●	●	●	●								
	ERST20D-MEC																	
	ERST20D-VM2C																	
	EHPT20X-VM2C																	
EHPT20X-VM6C																		
EHPT20X-YM9C																		
EHPT20X-TM9C																		
EHPT20X-MHCW																		
HYDROBOX	EHSC-VM2C	●	●	●	●		●	●	●	●	●	●	●	●	●	●	●	●
	EHSC-VM2EC	●	●	●	●		●	●	●	●	●	●	●	●	●	●	●	●
	EHSC-VM6C	●	●	●	●		●	●	●	●	●	●	●	●	●	●	●	●
	EHSC-VM6EC	●	●	●	●		●	●	●	●	●	●	●	●	●	●	●	●
	EHSC-YM9C	●	●	●	●		●	●	●	●	●	●	●	●	●	●	●	●
	EHSC-YM9EC	●	●	●	●		●	●	●	●	●	●	●	●	●	●	●	●
	EHSC-TM9C	●	●	●	●		●	●	●	●	●	●	●	●	●	●	●	●
	EHSC-MEC	●	●	●	●		●	●	●	●								
	EHSD-VM2C																	
	EHSD-YM9C																	
	EHSD-MEC																	
	EHSD-MC																	
	ERSC-VM2C	●	●	●	●		●	●	●	●								
	ERSC-MEC	●	●	●	●		●	●	●	●								
	ERSD-VM2C																	
	EHPX-VM2C																	
	EHPX-VM6C																	
	EHPX-YM9C																	
	EHSE-YM9EC						●											
	EHSE-MEC						●											
ERSE-YM9EC						●												
ERSE-MEC						●												

● : Combination is available.
 Blank: Combination is NOT available.

1.2 Cylinder unit

Model name			EHST20C-VM2C	EHST20C-VM6C	EHST20C-VM9C	EHST20C-TM9C	EHST20C-VM2EC	EHST20C-VM6EC		
Dimensions	Without package	Height	mm	1600	1600	1600	1600	1600		
		Width	mm	595	595	595	595	595		
		Depth	mm	680	680	680	680	680		
	With package	Height	mm	1850	1850	1850	1850	1850		
		Width	mm	660	660	660	660	660		
		Depth	mm	800	800	800	800	800		
Casing	Munsell	-	6.2PB 9/0.9	6.2PB 9/0.9	6.2PB 9/0.9	6.2PB 9/0.9	6.2PB 9/0.9	6.2PB 9/0.9		
	RAL code	-	260 90 05	260 90 05	260 90 05	260 90 05	260 90 05	260 90 05		
	Material	-	Pre-coated metal	Pre-coated metal	Pre-coated metal	Pre-coated metal	Pre-coated metal	Pre-coated metal		
Product weight (empty)		kg	110	111	112	112	104	105		
Product weight (full)		kg	320	321	322	322	314	315		
Gross weight		kg	127	128	129	129	121	122		
Water volume of heating circuit in the unit *1		L	6.6	6.6	6.6	6.6	6.6	6.6		
Type of Installation		-	Floor standing	Floor standing	Floor standing	Floor standing	Floor standing	Floor standing		
Electrical data	Control board *2 (Including 4 pumps)	Power supply	Ph	~N	~N	~N	~N	~N	~N	
			V	230	230	230	230	230	230	
			Hz	50	50	50	50	50	50	
		Input	kW	0.30	0.30	0.30	0.30	0.30	0.30	
			Current	A	1.95	1.95	1.95	1.95	1.95	1.95
			Breaker	A	10	10	10	10	10	10
	Booster heater	Power supply	Ph	~N	~N	3~	3~	~N	~N	
			V	230	230	400	230	230	230	
			Hz	50	50	50	50	50	50	
		Capacity	kW	2	2+4	3+6	3+6	2	2+4	
		Heater step	-	1	3	3	3	1	3	
		Current	A	9	26	13	23	9	26	
	Immersion heater	Power supply	Ph	-	-	-	-	-	-	
			V	-	-	-	-	-	-	
			Hz	-	-	-	-	-	-	
		Capacity	kW	-	-	-	-	-	-	
		Current	A	-	-	-	-	-	-	
		Breaker	A	-	-	-	-	-	-	
	Water circulation pump (Primary circuit)	Input (10/20/27.7 L/min)*3	Speed 1	W	18/25/29	18/25/29	18/25/29	18/25/29	18/25/29	
			Speed 2	W	25/34/41	25/34/41	25/34/41	25/34/41	25/34/41	
			Speed 3	W	34/46/56	34/46/56	34/46/56	34/46/56	34/46/56	
Speed 4			W	45/60/63	45/60/63	45/60/63	45/60/63	45/60/63		
Speed 5			W	57/63/63	57/63/63	57/63/63	57/63/63	57/63/63		
Current (10/20/27.7 L/min)*3			A	0.1/0.2/0.2	0.1/0.2/0.2	0.1/0.2/0.2	0.1/0.2/0.2	0.1/0.2/0.2		
Head difference		0L/min@Speed 5	m	7.0	7.0	7.0	7.0	7.0		
		20L/min@Speed 5	m	5.9	5.9	5.9	5.9	5.9		
		27.7L/min@Speed 5	m	4.7	4.7	4.7	4.7	4.7		
		DC motor	-	-	-	-	-	-		
Water circulation pump (DHW circuit)	Input	Speed I	W	58	58	58	58	58		
		Speed II (Default setting)	W	72	72	72	72	72		
		Speed III	W	83	83	83	83	83		
	Current	Speed I	A	0.27	0.27	0.27	0.27	0.27		
		Speed II (Default setting)	A	0.33	0.33	0.33	0.33	0.33		
		Speed III	A	0.36	0.36	0.36	0.36	0.36		
	Flow rate	Speed I	L/min	14.5	14.5	14.5	14.5	14.5		
		Speed II (Default setting)	L/min	21.0	21.0	21.0	21.0	21.0		
		Speed III	L/min	25.2	25.2	25.2	25.2	25.2		
Flow rate	Primary circuit	Max.*4	L/min	27.7	27.7	27.7	27.7	27.7		
	Min.*5	L/min	5.0	5.0	5.0	5.0	5.0			
Heat exchanger	Refrigerant - Primary circuit water	-	Plate	Plate	Plate	Plate	Plate			
	Primary circuit water - Domestic hot water	-	Plate	Plate	Plate	Plate	Plate			
Domestic hot water tank	Volume	L	200	200	200	200	200			
	Material	-	Duplex 2304 stainless steel (EN10088)	Duplex 2304 stainless steel (EN10088)	Duplex 2304 stainless steel (EN10088)	Duplex 2304 stainless steel (EN10088)	Duplex 2304 stainless steel (EN10088)			
	Time to raise DHW tank temp 15 - 65°C *6	min	22.75	22.75	22.75	22.75	22.75			
	Time to reheat 70% of DHW tank to 65°C *6	min	17.17	17.17	17.17	17.17	17.17			
	Heat loss *7	kWh/24h	1.91	1.91	1.91	1.91	1.91			
Expansion vessel (Primary circuit)	Volume	L	12	12	12	12	-			
	Charge pressure	MPa	0.1	0.1	0.1	0.1	-			
Safety device	Primary circuit	Control thermistor	°C	1~80	1~80	1~80	1~80	1~80		
		Pressure relief valve	MPa	0.3	0.3	0.3	0.3	0.3		
		Flow sensor (Min. flow)	L/min	5.0	5.0	5.0	5.0	5.0		
		BH manual reset thermostat	°C	90	90	90	90	90		
		BH thermal Cut Off	°C	121	121	121	121	121		
	DHW tank	Control thermistor	°C	75	75	75	75	75		
		IH manual reset thermostat	°C	-	-	-	-	-		
		Temperature & pressure relief valve	°C	-	-	-	-	-		
		MPa	MPa	1.0	1.0	1.0	1.0	1.0		
		MPa	MPa	1.0	1.0	1.0	1.0	1.0		
Connections	Water	Primary circuit	mm	φ28	φ28	φ28	φ28	φ28		
		DHW circuit	mm	φ22	φ22	φ22	φ22	φ22		
	Refrigerant	Gas	mm	φ15.88	φ15.88	φ15.88	φ15.88	φ15.88		
		Liquid	mm	φ9.52	φ9.52	φ9.52	φ9.52	φ9.52		
Refrigerant *8	-	R410A	R410A	R410A	R410A	R410A				
Guaranteed operating range *9	Ambient	°C	0~35	0~35	0~35	0~35	0~35			
		%RH	≤80	≤80	≤80	≤80	≤80			
	Outdoor temperature	Heating	°C	See outdoor unit spec table						
Operating range	Heating	Room temperature	°C	10~30	10~30	10~30	10~30	10~30		
		Flow temperature	°C	25~60	25~60	25~60	25~60	25~60		
	Cooling	Room temperature	°C	-	-	-	-	-		
		Flow temperature	°C	-	-	-	-	-		
	DHW *10	°C	40~60	40~60	40~60	40~60	40~60			
		°C	60~70	60~70	60~70	60~70	60~70			
Sound pressure level	dB(A)	28	28	28	28	28				
Sound power level	dB(A)	40	40	40	40	40				

*1 Volume of sanitary water circuit, primary DHW circuit (from 3-way valve to confluent point with Heating circuit), piping to Expansion vessel, and Expansion vessel is not included in this value.
 *2 When powered from independent source.
 *3 Allowable flow rate range differs depending on connected outdoor unit. Please refer to section 4.2.
 *4 If the water flow rate exceeds maximum, the flow speed will be greater than 1.5 m/s, which could corrode the pipes.
 *5 If the water flow is less than the minimum, the flow error will be activated.

*6 Tested under BS7206 conditions (Primary flow to cylinder coil 80-82 deg C). Conducted by WRc.
 *7 Calculated from 24h temperature decay at top of the tank from 65degC (ambient temperature approx. 20degC). Tested by WRc.
 *8 Refrigerant of outdoor unit connected to cylinder unit.
 *9 The environment must be frost-free.
 *10 For the model without both booster heater and immersion heater, the max. hot water temperature is [Max. outlet water of outdoor unit -3°C]. For the max. outlet of outdoor unit, refer to outdoor unit spec table.

1 Specifications

Cylinder unit / Hydrobox

Model name			EHST20C-YM9EC	EHST20C-MEC	EHST20D-VM2C	EHST20D-MEC	EHST20D-MHC	EHPT20X-VM2C	
Dimensions	Without package	Height	mm	1600	1600	1600	1600	1600	1600
		Width	mm	595	595	595	595	595	595
		Depth	mm	680	680	680	680	680	680
	With package	Height	mm	1850	1850	1850	1850	1850	1850
		Width	mm	660	660	660	660	660	660
		Depth	mm	800	800	800	800	800	800
Casing	Munsell	-	6.2PB 9/0.9	6.2PB 9/0.9	6.2PB 9/0.9	6.2PB 9/0.9	6.2PB 9/0.9	6.2PB 9/0.9	
	RAL code	-	260 90 05	260 90 05	260 90 05	260 90 05	260 90 05	260 90 05	
	Material	-	Pre-coated metal	Pre-coated metal	Pre-coated metal	Pre-coated metal	Pre-coated metal	Pre-coated metal	
Product weight (empty)		kg	106	103	103	96	103	98	
Product weight (full)		kg	316	313	312	305	312	307	
Gross weight		kg	123	120	120	113	120	115	
Water volume of heating circuit in the unit *1		L	6.6	6.6	5.7	5.7	5.7	5.9	
Type of Installation		-	Floor standing	Floor standing	Floor standing	Floor standing	Floor standing	Floor standing	
Electrical data	Control board *2 (Including 4 pumps)	Power supply	Ph	~N	~N	~N	~N	~N	~N
			V	230	230	230	230	230	230
			Hz	50	50	50	50	50	50
		Input	kW	0.30	0.30	0.30	0.30	0.30	0.30
			Current	A	1.95	1.95	1.95	1.95	1.95
			Breaker	A	10	10	10	10	10
	Booster heater	Power supply	Ph	3~	-	~N	-	-	~N
			V	400	-	230	-	-	230
			Hz	50	-	50	-	-	50
		Capacity	kW	3+6	-	2	-	-	2
		Heater step	-	3	-	1	-	-	1
		Current	A	13	-	9	-	-	9
	Immersion heater	Power supply	Ph	-	-	-	-	~N	-
			V	-	-	-	-	230	-
			Hz	-	-	-	-	50	-
		Capacity	kW	-	-	-	-	3	-
		Current	A	-	-	-	-	13	-
		Breaker	A	-	-	-	-	16	-
Water circulation pump (Primary circuit)	Input (10/20/27.7 L/min)*3	Speed 1	W	18/25/29	18/25/29	18/25/29	18/25/29	18/25/29	18/25/29
		Speed 2	W	25/34/41	25/34/41	25/34/41	25/34/41	25/34/41	25/34/41
		Speed 3	W	34/46/56	34/46/56	34/46/56	34/46/56	34/46/56	34/46/56
		Speed 4	W	45/60/63	45/60/63	45/60/63	45/60/63	45/60/63	45/60/63
		Speed 5	W	57/63/63	57/63/63	57/63/63	57/63/63	57/63/63	57/63/63
		Current (10/20/27.7 L/min)*3	Speed 1	A	0.1/0.2/0.2	0.1/0.2/0.2	0.1/0.2/0.2	0.1/0.2/0.2	0.1/0.2/0.2
	Head difference	Speed 2	A	0.2/0.3/0.3	0.2/0.3/0.3	0.2/0.3/0.3	0.2/0.3/0.3	0.2/0.3/0.3	
		Speed 3	A	0.3/0.3/0.4	0.3/0.3/0.4	0.3/0.3/0.4	0.3/0.3/0.4	0.3/0.3/0.4	
		Speed 4	A	0.3/0.4/0.5	0.3/0.4/0.5	0.3/0.4/0.5	0.3/0.4/0.5	0.3/0.4/0.5	
		Speed 5	A	0.4/0.5/0.5	0.4/0.5/0.5	0.4/0.5/0.5	0.4/0.5/0.5	0.4/0.5/0.5	
		0L/min@Speed 5	m	7.0	7.0	7.0	7.0	7.0	
		20L/min@Speed 5	m	5.9	5.9	5.9	5.9	5.9	
Water circulation pump (DHW circuit)	Input	Speed I	W	58	58	58	58	58	
		Speed II (Default setting)	W	72	72	72	72	72	
		Speed III	W	83	83	83	83	83	
	Current	Speed I	A	0.27	0.27	0.27	0.27	0.27	
		Speed II (Default setting)	A	0.33	0.33	0.33	0.33	0.33	
		Speed III	A	0.36	0.36	0.36	0.36	0.36	
Flow rate	Speed I	L/min	14.5	14.5	14.5	14.5	14.5		
	Speed II (Default setting)	L/min	21.0	21.0	21.0	21.0	21.0		
	Speed III	L/min	25.2	25.2	25.2	25.2	25.2		
Flow rate	Primary circuit	Max.*4	L/min	27.7	27.7	27.7	27.7	27.7	
	Min.*5	L/min	5.0	5.0	5.0	5.0	5.0		
Heat exchanger	Refrigerant - Primary circuit water	-	Plate	Plate	Plate	Plate	Plate		
	Primary circuit water - Domestic hot water	-	Plate	Plate	Plate	Plate	Plate		
Domestic hot water tank	Volume	L	200	200	200	200	200		
	Material	-	Duplex 2304 stainless steel (EN10088)	Duplex 2304 stainless steel (EN10088)	Duplex 2304 stainless steel (EN10088)	Duplex 2304 stainless steel (EN10088)	Duplex 2304 stainless steel (EN10088)		
	Time to raise DHW tank temp 15 - 65°C *6	min	22.75	22.75	22.75	22.75	22.75		
	Time to reheat 70% of DHW tank to 65°C *6	min	17.17	17.17	17.17	17.17	17.17		
Expansion vessel (Primary circuit)	Heat loss *7	kWh/24h	1.91	1.91	1.91	1.91	1.91		
	Volume	L	-	-	-	-	-		
Safety device	Primary circuit	Charge pressure	MPa	-	-	0.1	-	0.1	
		Control thermistor	°C	1~80	1~80	1~80	1~80	1~80	
		Pressure relief valve	MPa	0.3	0.3	0.3	0.3	0.3	
		Flow sensor (Min. flow)	L/min	5.0	5.0	5.0	5.0	5.0	
		BH manual reset thermostat	°C	90	-	90	-	90	
	DHW tank	BH thermal Cut Off	°C	121	-	121	-	121	
		Control thermistor	°C	75	75	75	75	75	
		IH manual reset thermostat	°C	-	-	-	-	85	
Connections	Water	Temperature & pressure relief valve	°C	-	-	-	-	-	
		MPa	1.0	1.0	1.0	1.0	1.0		
Refrigerant *8	Water	Primary circuit	mm	φ28	φ28	φ28	φ28	φ28	
		DHW circuit	mm	φ22	φ22	φ22	φ22	φ22	
	Refrigerant	Gas	mm	φ15.88	φ15.88	φ12.7	φ12.7	φ12.7	
		Liquid	mm	φ9.52	φ9.52	φ6.35	φ6.35	φ6.35	
Guaranteed operating range *9	Ambient	°C	0~35	0~35	0~35	0~35	0~35		
		%RH	≤80	≤80	≤80	≤80	≤80		
Operating range	Heating	Room temperature	°C	10~30	10~30	10~30	10~30	10~30	
		Flow temperature	°C	25~60	25~60	25~60	25~60	25~60	
	Cooling	Room temperature	°C	-	-	-	-	-	
		Flow temperature	°C	-	-	-	-	-	
	DHW *10	°C	40~60	40~60	40~60	40~60	40~60		
		°C	60~70	60~70	60~70	60~70	60~70		
Sound pressure level	dB(A)	28	28	28	28	28			
	dB(A)	40	40	40	40	40			

*1 Volume of sanitary water circuit, primary DHW circuit (from 3-way valve to confluent point with Heating circuit), piping to Expansion vessel, and Expansion vessel is not included in this value.
 *2 When powered from independent source.
 *3 Allowable flow rate range differs depending on connected outdoor unit. Please refer to section 4.2.
 *4 If the water flow rate exceeds maximum, the flow speed will be greater than 1.5 m/s, which could corrode the pipes.
 *5 If the water flow is less than the minimum, the flow error will be activated.

*6 Tested under BS7206 conditions (Primary flow to cylinder coil 80-82 deg C). Conducted by WRc.
 *7 Calculated from 24h temperature decay at top of the tank from 65degC (ambient temperature approx. 20degC). Tested by WRc.
 *8 Refrigerant of outdoor unit connected to cylinder unit.
 *9 The environment must be frost-free.
 *10 For the model without both booster heater and immersion heater, the max. hot water temperature is [Max. outlet water of outdoor unit -3°C]. For the max. outlet of outdoor unit, refer to outdoor unit spec table.

1 Specifications

Cylinder unit / Hydrobox

Model name			EHPT20X-VM6C	EHPT20X-YM9C	EHPT20X-TM9C	EHPT20X-MHCW	EHST20C-MHCW	EHST20D-MHCW		
Dimensions	Without package	Height	mm	1600	1600	1600	1600	1600		
		Width	mm	595	595	595	595	595		
		Depth	mm	680	680	680	680	680		
	With package	Height	mm	1850	1850	1850	1850	1850		
		Width	mm	660	660	660	660	660		
		Depth	mm	800	800	800	800	800		
Casing	Munsell	-	6.2PB 9/0.9	6.2PB 9/0.9	6.2PB 9/0.9	6.2PB 9/0.9	6.2PB 9/0.9	6.2PB 9/0.9		
	RAL code	-	260 90 05	260 90 05	260 90 05	260 90 05	260 90 05	260 90 05		
	Material	-	Pre-coated metal	Pre-coated metal	Pre-coated metal	Pre-coated metal	Pre-coated metal	Pre-coated metal		
Product weight (empty)		kg	99	100	100	98	110	103		
Product weight (full)		kg	308	309	309	307	320	312		
Gross weight		kg	116	117	117	115	127	120		
Water volume of heating circuit in the unit *1		L	5.9	5.9	5.9	5.9	6.6	5.7		
Type of Installation		-	Floor standing	Floor standing	Floor standing	Floor standing	Floor standing	Floor standing		
Electrical data	Control board *2 (Including 4 pumps)	Power supply	Ph	~N	~N	~N	~N	~N		
			V	230	230	230	230	230		
			Hz	50	50	50	50	50		
		Input	kW	0.30	0.30	0.30	0.30	0.30		
			Current	A	1.95	1.95	1.95	1.95	1.95	
			Breaker	A	10	10	10	10	10	
	Booster heater	Power supply	Ph	~N	3~	3~	-	-		
			V	230	400	230	-	-		
			Hz	50	50	50	-	-		
		Capacity	kW	2+4	3+6	3+6	-	-		
			Heater step	-	3	3	-	-		
			Current	A	26	13	23	-	-	
	Immersion heater	Power supply	Ph	-	-	-	~N	~N		
			V	-	-	-	230	230		
			Hz	-	-	-	50	50		
		Capacity	kW	-	-	-	3	3		
			Current	A	-	-	-	13	13	
			Breaker	A	-	-	-	16	16	
	Water circulation pump (Primary circuit)	Type	-	DC motor						
			Input (10/20/27.7 L/min)*3	Speed 1	W	18/25/29	18/25/29	18/25/29	18/25/29	18/25/29
				Speed 2	W	25/34/41	25/34/41	25/34/41	25/34/41	25/34/41
				Speed 3	W	34/46/56	34/46/56	34/46/56	34/46/56	34/46/56
				Speed 4	W	45/60/63	45/60/63	45/60/63	45/60/63	45/60/63
		Speed 5		W	57/63/63	57/63/63	57/63/63	57/63/63	57/63/63	
Performance curve: please refer to section 4.3		Current (10/20/27.7 L/min)*3	Speed 1	A	0.1/0.2/0.2	0.1/0.2/0.2	0.1/0.2/0.2	0.1/0.2/0.2	0.1/0.2/0.2	
			Speed 2	A	0.2/0.3/0.3	0.2/0.3/0.3	0.2/0.3/0.3	0.2/0.3/0.3	0.2/0.3/0.3	
			Speed 3	A	0.3/0.3/0.4	0.3/0.3/0.4	0.3/0.3/0.4	0.3/0.3/0.4	0.3/0.3/0.4	
			Speed 4	A	0.3/0.4/0.5	0.3/0.4/0.5	0.3/0.4/0.5	0.3/0.4/0.5	0.3/0.4/0.5	
			Speed 5	A	0.4/0.5/0.5	0.4/0.5/0.5	0.4/0.5/0.5	0.4/0.5/0.5	0.4/0.5/0.5	
Head difference		0L/min@Speed 5	m	7.0	7.0	7.0	7.0	7.0		
		20L/min@Speed 5	m	5.9	5.9	5.9	5.9	5.9		
		27.7L/min@Speed 5	m	4.7	4.7	4.7	4.7	4.7		
		Water circulation pump (DHW circuit)	Input	Speed I	W	58	58	58	58	
	Speed II (Default setting)			W	72	72	72	72		
Speed III	W			83	83	83	83			
Current	Speed I		A	0.27	0.27	0.27	0.27			
	Speed II (Default setting)		A	0.33	0.33	0.33	0.33			
	Speed III		A	0.36	0.36	0.36	0.36			
Flow rate	Speed I	L/min	14.5	14.5	14.5	14.5				
	Speed II (Default setting)	L/min	21.0	21.0	21.0	21.0				
	Speed III	L/min	25.2	25.2	25.2	25.2				
Flow rate	Primary circuit	Max.*4	L/min	27.7	27.7	27.7	27.7			
		Min.*5	L/min	5.0	5.0	5.0	5.0			
Heat exchanger	Refrigerant - Primary circuit water	-	-	-	-	-	Plate			
	Primary circuit water - Domestic hot water	-	Plate	Plate	Plate	Plate	Plate			
Domestic hot water tank	Volume	L	200	200	200	200	200			
	Material	-	Duplex 2304 stainless steel (EN10088)	Duplex 2304 stainless steel (EN10088)	Duplex 2304 stainless steel (EN10088)	Duplex 2101 stainless steel (EN10088)	Duplex 2101 stainless steel (EN10088)			
	Time to raise DHW tank temp 15 - 65°C *6	min	22.75	22.75	22.75	22.75	22.75			
	Time to reheat 70% of DHW tank to 65°C *6	min	17.17	17.17	17.17	17.17	17.17			
	Heat loss *7	kWh/24h	1.91	1.91	1.91	1.91	1.91			
Expansion vessel (Primary circuit)	Volume	L	12	12	12	12	12			
	Charge pressure	MPa	0.1	0.1	0.1	0.1	0.1			
Safety device	Primary circuit	Control thermistor	°C	1~80	1~80	1~80	1~80			
		Pressure relief valve	MPa	0.3	0.3	0.3	0.3			
		Flow sensor (Min. flow)	L/min	5.0	5.0	5.0	5.0			
		BH manual reset thermostat	°C	90	90	90	-			
		BH thermal Cut Off	°C	121	121	121	-			
	DHW tank	Control thermistor	°C	75	75	75	75			
		IH manual reset thermostat	°C	-	-	-	85			
		Temperature & pressure relief valve	°C	-	-	-	90			
			MPa	1.0	1.0	1.0	0.7			
			MPa	1.0	1.0	1.0	0.7			
Connections	Water	Primary circuit	mm	φ28	φ28	φ28	φ28			
		DHW circuit	mm	φ22	φ22	φ22	φ22			
	Refrigerant	Gas	mm	-	-	-	φ15.88			
		Liquid	mm	-	-	-	φ9.52			
			mm	-	-	-	φ6.35			
Refrigerant *8	-	R410A	R410A	R410A	R410A	R410A				
Guaranteed operating range *9	Ambient	°C	0~35	0~35	0~35	0~35				
		%RH	≤80	≤80	≤80	≤80				
	Outdoor temperature	°C	See outdoor unit spec table							
Operating range	Heating	Room temperature	°C	10~30	10~30	10~30	10~30			
		Flow temperature	°C	25~60	25~60	25~60	25~60			
	Cooling	Room temperature	°C	-	-	-	-			
		Flow temperature	°C	-	-	-	-			
	DHW *10	°C	40~60	40~60	40~60	40~60				
		Legionella prevention *10	°C	60~70	60~70	60~70	60~70			
Sound pressure level		dB(A)	28	28	28	28				
Sound power level		dB(A)	40	40	40	40				

*1 Volume of sanitary water circuit, primary DHW circuit (from 3-way valve to confluent point with Heating circuit), piping to Expansion vessel, and Expansion vessel is not included in this value.
 *2 When powered from independent source.
 *3 Allowable flow rate range differs depending on connected outdoor unit. Please refer to section 4.2.
 *4 If the water flow rate exceeds maximum, the flow speed will be greater than 1.5 m/s, which could corrode the pipes.
 *5 If the water flow is less than the minimum, the flow error will be activated.

*6 Tested under BST206 conditions (Primary flow to cylinder coil 80-82 deg C). Conducted by WRC.
 *7 Calculated from 24h temperature decay at top of the tank from 65degC (ambient temperature approx. 20degC). Tested by WRC.
 *8 Refrigerant of outdoor unit connected to cylinder unit.
 *9 The environment must be frost-free.
 *10 For the model without both booster heater and immersion heater, the max. hot water temperature is [Max. outlet water of outdoor unit -3°C]. For the max. outlet of outdoor unit, refer to outdoor unit spec table.

1 Specifications

Cylinder unit / Hydrobox

Model name				EHS20D-VM2EC	EHS20D-VM9C	ERST20C-VM2C	ERST20C-MEC	ERST20D-VM2C	ERST20D-MEC	
Dimensions	Without package	Height	mm	1600	1600	1600	1600	1600	1600	
		Width	mm	595	595	595	595	595	595	
		Depth	mm	680	680	680	680	680	680	
	With package	Height	mm	1850	1850	1850	1850	1850	1850	
		Width	mm	660	660	660	660	660	660	
		Depth	mm	800	800	800	800	800	800	
Casing	Munsell	-	6.2PB 9/0.9	6.2PB 9/0.9	6.2PB 9/0.9	6.2PB 9/0.9	6.2PB 9/0.9	6.2PB 9/0.9	6.2PB 9/0.9	
	RAL code	-	260 90 05	260 90 05	260 90 05	260 90 05	260 90 05	260 90 05	260 90 05	
Material		-	Pre-coated metal	Pre-coated metal	Pre-coated metal	Pre-coated metal	Pre-coated metal	Pre-coated metal	Pre-coated metal	
Product weight (empty)		kg	97	105	110	103	103	103	96	
Product weight (full)		kg	306	314	320	313	312	312	305	
Gross weight		kg	114	122	127	120	120	120	113	
Water volume of heating circuit in the unit *1		L	5.7	5.7	6.6	6.6	6.6	5.7	5.7	
Type of Installation		-	Floor standing	Floor standing	Floor standing	Floor standing	Floor standing	Floor standing	Floor standing	
Electrical data	Control board *2 (Including 4 pumps)	Power supply	Ph	~N	~N	~N	~N	~N	~N	
			V	230	230	230	230	230	230	
			Hz	50	50	50	50	50	50	
		Input	kW	0.30	0.30	0.30	0.30	0.30	0.30	
		Current	A	1.95	1.95	1.95	1.95	1.95	1.95	
		Breaker	A	10	10	10	10	10	10	
	Booster heater	Power supply	Ph	~N	3~	~N	-	~N	-	
			V	230	400	230	-	230	-	
			Hz	50	50	50	-	50	-	
		Capacity	kW	2	3+6	2	-	2	-	
		Heater step	-	1	3	1	-	1	-	
		Current	A	9	13	9	-	9	-	
	Immersion heater	Power supply	Ph	-	-	-	-	-	-	
			V	-	-	-	-	-	-	
			Hz	-	-	-	-	-	-	
		Capacity	kW	-	-	-	-	-	-	
		Current	A	-	-	-	-	-	-	
		Breaker	A	-	-	-	-	-	-	
Water circulation pump (Primary circuit)	Type	DC motor								
		Input (10/20/27.7 L/min)*3	Speed 1	W	18/25/29	18/25/29	19/26/32	19/26/32	19/26/32	19/26/32
			Speed 2	W	25/34/41	25/34/41	26/37/45	26/37/45	26/37/45	26/37/45
			Speed 3	W	34/46/56	34/46/56	34/49/60	34/49/60	34/49/60	34/49/60
			Speed 4	W	45/60/63	45/60/63	45/65/70	45/65/70	45/65/70	45/65/70
	Speed 5		W	57/63/63	57/63/63	57/70/70	57/70/70	57/70/70	57/70/70	
	Performance curve: please refer to section 4.3	Current (10/20/27.7 L/min)*3	Speed 1	A	0.1/0.2/0.2	0.1/0.2/0.2	0.2/0.2/0.3	0.2/0.2/0.3	0.2/0.2/0.3	0.2/0.2/0.3
			Speed 2	A	0.2/0.3/0.3	0.2/0.3/0.3	0.2/0.3/0.4	0.2/0.3/0.4	0.2/0.3/0.4	0.2/0.3/0.4
			Speed 3	A	0.3/0.3/0.4	0.3/0.3/0.4	0.3/0.4/0.5	0.3/0.4/0.5	0.3/0.4/0.5	0.3/0.4/0.5
			Speed 4	A	0.3/0.4/0.5	0.3/0.4/0.5	0.4/0.5/0.6	0.4/0.5/0.6	0.4/0.5/0.6	0.4/0.5/0.6
			Speed 5	A	0.4/0.5/0.5	0.4/0.5/0.5	0.5/0.6/0.6	0.5/0.6/0.6	0.5/0.6/0.6	0.5/0.6/0.6
	Head difference	0L/min@Speed 5	m	7.0	7.0	7.0	7.0	7.0	7.0	
20L/min@Speed 5		m	5.9	5.9	5.9	5.9	5.9	5.9		
27.7L/min@Speed 5		m	4.7	4.7	4.7	4.7	4.7	4.7		
Water circulation pump (DHW circuit)	Input	Speed I	W	58	58	58	58	58	58	
		Speed II (Default setting)	W	72	72	72	72	72	72	
		Speed III	W	83	83	83	83	83	83	
	Current	Speed I	A	0.27	0.27	0.27	0.27	0.27	0.27	
		Speed II (Default setting)	A	0.33	0.33	0.33	0.33	0.33	0.33	
		Speed III	A	0.36	0.36	0.36	0.36	0.36	0.36	
	Flow rate	Speed I	L/min	14.5	14.5	14.5	14.5	14.5	14.5	
		Speed II (Default setting)	L/min	21.0	21.0	21.0	21.0	21.0	21.0	
		Speed III	L/min	25.2	25.2	25.2	25.2	25.2	25.2	
Flow rate	Primary circuit	Max.*4	L/min	27.7	27.7	27.7	27.7	27.7	27.7	
		Min.*5	L/min	5.0	5.0	5.0	5.0	5.0	5.0	
Heat exchanger	Refrigerant - Primary circuit water	-	Plate	Plate	Plate	Plate	Plate	Plate		
	Primary circuit water - Domestic hot water	-	Plate	Plate	Plate	Plate	Plate	Plate		
Domestic hot water tank	Volume	L	200	200	200	200	200	200		
	Material	-	Duplex 2304 stainless steel (EN10088)	Duplex 2304 stainless steel (EN10088)	Duplex 2304 stainless steel (EN10088)	Duplex 2304 stainless steel (EN10088)	Duplex 2304 stainless steel (EN10088)	Duplex 2304 stainless steel (EN10088)		
	Time to raise DHW tank temp 15 - 65°C *6	min	22.75	22.75	22.75	22.75	22.75	22.75		
	Time to reheat 70% of DHW tank to 65°C *6	min	17.17	17.17	17.17	17.17	17.17	17.17		
	Heat loss *7	kWh/24h	1.91	1.91	1.91	1.91	1.91	1.91		
Expansion vessel (Primary circuit)	Volume	L	-	12	12	-	12	-		
	Charge pressure	MPa	-	0.1	0.1	-	0.1	-		
Safety device	Primary circuit	Control thermistor	°C	1~80	1~80	1~80	1~80	1~80	1~80	
		Pressure relief valve	MPa	0.3	0.3	0.3	0.3	0.3	0.3	
		Flow sensor (Min. flow)	L/min	5.0	5.0	5.0	5.0	5.0	5.0	
		BH manual reset thermostat	°C	90	90	90	90	90	90	
		BH thermal Cut Off	°C	121	121	121	121	121	121	
		Control thermistor	°C	75	75	75	75	75	75	
	DHW tank	IH manual reset thermostat	°C	-	-	-	-	-	-	
		Temperature & pressure relief valve	°C	-	-	-	-	-	-	
			MPa	1.0	1.0	1.0	1.0	1.0	1.0	
			MPa	1.0	1.0	1.0	1.0	1.0	1.0	
Connections	Water	Primary circuit	mm	φ28	φ28	φ28	φ28	φ28	φ28	
		DHW circuit	mm	φ22	φ22	φ22	φ22	φ22	φ22	
	Refrigerant	Gas	mm	φ12.7	φ12.7	φ15.88	φ15.88	φ12.7	φ12.7	
		Liquid	mm	φ6.35	φ6.35	φ9.52	φ9.52	φ6.35	φ6.35	
Refrigerant *8	-	R410A	R410A	R410A	R410A	R410A	R410A			
Guaranteed operating range *9	Ambient	°C	0~35	0~35	0~35	0~35	0~35	0~35		
		%RH	≤80	≤80	≤80	≤80	≤80	≤80		
	Outdoor temperature	Heating	°C	-	-	See outdoor unit spec table				
Operating range	Heating	Room temperature	°C	10~30	10~30	10~30	10~30	10~30	10~30	
		Flow temperature	°C	25~60	25~60	25~60	25~60	25~60	25~60	
	Cooling	Room temperature	°C	-	-	-	-	-	-	
		Flow temperature	°C	-	-	5~25	5~25	5~25	5~25	
	DHW *10	°C	40~60	40~60	40~60	40~60	40~60	40~60		
		Legionella prevention *10	°C	60~70	60~70	60~70	60~70	60~70	60~70	
Sound pressure level	dB(A)	28	28	28	28	28	28			
Sound power level	dB(A)	40	40	40	40	40	40			

*1 Volume of sanitary water circuit, primary DHW circuit (from 3-way valve to confluent point with Heating circuit), piping to Expansion vessel, and Expansion vessel is not included in this value.
 *2 When powered from independent source.
 *3 Allowable flow rate range differs depending on connected outdoor unit. Please refer to section 4.2.
 *4 If the water flow rate exceeds maximum, the flow speed will be greater than 1.5 m/s, which could corrode the pipes.
 *5 If the water flow is less than the minimum, the flow error will be activated.
 *6 Tested under BS7206 conditions (Primary flow to cylinder coil 80-82 deg C). Conducted by WRc.

*7 Calculated from 24h temperature decay at top of the tank from 65degC (ambient temperature approx. 20degC). Tested by WRc.
 *8 Refrigerant of outdoor unit connected to cylinder unit.
 *9 The environment must be frost-free.
 *10 For the model without both booster heater and immersion heater, the max. hot water temperature is [Max. outlet water of outdoor unit -3°C]. For the max. outlet of outdoor unit, refer to outdoor unit spec table.
 *11 Cooling mode is not available in low outdoor temperature. If you use our system in cooling mode at the low ambient temperature (10°C or below), there are some risks of plate heat exchanger breaking by frozen water.

Cylinder / Hydrobox

1.3 Hydrobox

Model name			EHSD-MEC		EHSD-VM2C		EHSC-MEC		EHSC-VM2C		EHSC-VM2EC	
Dimensions	Without package	Height	mm	800	800	800	800	800	800	800	800	800
		Width	mm	530	530	530	530	530	530	530	530	530
		Depth	mm	360	360	360	360	360	360	360	360	360
	With package	Height	mm	990	990	990	990	990	990	990	990	990
		Width	mm	600	600	600	600	600	600	600	600	600
		Depth	mm	560	560	560	560	560	560	560	560	560
Casing	Munsell	-	6.2PB 9/0.9	6.2PB 9/0.9	6.2PB 9/0.9	6.2PB 9/0.9	6.2PB 9/0.9	6.2PB 9/0.9	6.2PB 9/0.9	6.2PB 9/0.9	6.2PB 9/0.9	
	RAL code	-	260 90 05	260 90 05	260 90 05	260 90 05	260 90 05	260 90 05	260 90 05	260 90 05	260 90 05	
	Material	-	Pre-coated metal	Pre-coated metal	Pre-coated metal	Pre-coated metal	Pre-coated metal	Pre-coated metal	Pre-coated metal	Pre-coated metal	Pre-coated metal	
Product weight (empty)		kg	38	44	42	48	43	43	43	43	43	
Product weight (full)		kg	44	50	49	55	50	55	55	55	50	
Gross weight		kg	51	57	55	61	56	61	61	61	56	
Water volume of heating circuit in the unit *1		L	5.2	5.2	6.1	6.1	6.1	6.1	6.1	6.1	6.1	
Type of Installation		-	Wall mounted	Wall mounted	Wall mounted	Wall mounted	Wall mounted	Wall mounted	Wall mounted	Wall mounted	Wall mounted	
Electrical data	Control board *2 (Including 4 pumps)	Power supply	Ph	~N	~N	~N	~N	~N	~N	~N	~N	
			V	230	230	230	230	230	230			
			Hz	50	50	50	50	50	50			
		Input	kW	0.30	0.30	0.30	0.30	0.30	0.30			
			Current	A	1.95	1.95	1.95	1.95	1.95			
			Breaker	A	10	10	10	10	10			
	Booster heater	Power supply	Ph	-	~N	-	~N	~N	~N			
			V	-	230	-	230	230				
			Hz	-	50	-	50	50				
		Capacity	kW	-	2	-	2	2				
		Heater step	-	-	1	-	1	1				
		Current	A	-	9	-	9	9				
	Immersion heater	Power supply	Ph	-	-	-	-	-				
			V	-	-	-	-	-				
			Hz	-	-	-	-	-				
		Capacity	kW	-	-	-	-	-				
		Current	A	-	-	-	-	-				
		Breaker	A	-	-	-	-	-				
	Water circulation pump (Primary circuit)	Type	-	-	-	DC motor	-	-				
			Input (10/20/27.7 L/min)*3	Speed 1	W	18/25/29	18/25/29	18/25/29	18/25/29			
				Speed 2	W	25/34/41	25/34/41	25/34/41	25/34/41			
				Speed 3	W	34/46/56	34/46/56	34/46/56	34/46/56			
				Speed 4	W	45/60/63	45/60/63	45/60/63	45/60/63			
				Speed 5	W	57/63/63	57/63/63	57/63/63	57/63/63			
Current (10/20/27.7 L/min)*3		Speed 1	A	0.1/0.2/0.2	0.1/0.2/0.2	0.1/0.2/0.2	0.1/0.2/0.2					
		Speed 2	A	0.2/0.3/0.3	0.2/0.3/0.3	0.2/0.3/0.3	0.2/0.3/0.3					
		Speed 3	A	0.3/0.3/0.4	0.3/0.3/0.4	0.3/0.3/0.4	0.3/0.3/0.4					
		Speed 4	A	0.3/0.4/0.5	0.3/0.4/0.5	0.3/0.4/0.5	0.3/0.4/0.5					
		Speed 5	A	0.4/0.5/0.5	0.4/0.5/0.5	0.4/0.5/0.5	0.4/0.5/0.5					
Head difference		0L/min@Speed 5	m	7.0	7.0	7.0	7.0					
	20L/min@Speed 5	m	5.9	5.9	5.9	5.9						
	27.7L/min@Speed 5	m	4.7	4.7	4.7	4.7						
Water circulation pump (DHW circuit)	Input	Speed I	W	-	-	-	-					
		Speed II (Default setting)	W	-	-	-	-					
		Speed III	W	-	-	-	-					
	Current	Speed I	A	-	-	-	-					
		Speed II (Default setting)	A	-	-	-	-					
		Speed III	A	-	-	-	-					
	Flow rate	Speed I	L/min	-	-	-	-					
		Speed II (Default setting)	L/min	-	-	-	-					
		Speed III	L/min	-	-	-	-					
Flow rate	Primary circuit	Max.*4	L/min	27.7	27.7	27.7	27.7					
		Min.*5	L/min	5.0	5.0	5.0	5.0					
Heat exchanger	Refrigerant - Primary circuit water	-	Plate	Plate	Plate	Plate						
	Primary circuit water - Domestic hot water	-	-	-	-	-						
Domestic hot water tank	Volume	L	-	-	-	-						
	Material	-	-	-	-	-						
	Time to raise DHW tank temp 15 - 65°C *6	min	-	-	-	-						
	Time to reheat 70% of DHW tank to 65°C *6	min	-	-	-	-						
	Heat loss *7	kWh/24h	-	-	-	-						
Expansion vessel (Primary circuit)	Volume	L	-	10	-	10						
	Charge pressure	MPa	-	0.1	-	0.1						
Safety device	Primary circuit	Control thermistor	°C	1-80	1-80	1-80	1-80					
		Pressure relief valve	MPa	0.3	0.3	0.3	0.3					
		Flow sensor (Min. flow)	L/min	5.0	5.0	5.0	5.0					
		BH manual reset thermostat	°C	-	90	-	90					
		BH thermal Cut Off	°C	-	121	-	121					
		DHW tank	Control thermistor	°C	-	-	-	-				
	IH manual reset thermostat		°C	-	-	-	-					
	Temperature & pressure relief valve		°C	-	-	-	-					
	MPa		-	-	-	-						
	Connections		Water	Primary circuit	mm	φ28	φ28	φ28				
	Refrigerant		Gas	mm	φ12.7	φ12.7	φ15.88	φ15.88				
	Liquid	mm	φ6.35	φ6.35	φ9.52	φ9.52						
Refrigerant *8	-	-	R410A	R410A	R410A	R410A						
Guaranteed operating range *9	Ambient	°C	0-35	0-35	0-35	0-35						
		%RH	≤80	≤80	≤80	≤80						
	Outdoor temperature	Heating	°C	See outdoor unit spec table								
Operating range	Heating	Room temperature	°C	10-30	10-30	10-30	10-30					
		Flow temperature	°C	25-60	25-60	25-60	25-60					
	Cooling	Room temperature	°C	-	-	-	-					
		Flow temperature	°C	-	-	-	-					
	DHW	°C	-	-	-	-						
		Legionella prevention	°C	-	-	-						
Sound pressure level	dB(A)	28	28	28	28							
Sound power level	dB(A)	40	40	40	40							

*1 Volume of sanitary water circuit, primary DHW circuit (from 3-way valve to confluent point with Heating circuit), piping to Expansion vessel, and Expansion vessel is not included in this value.
 *2 When powered from independent source.
 *3 Allowable flow rate range differs depending on connected outdoor unit. Please refer to section 4.2.
 *4 If the water flow rate exceeds maximum, the flow speed will be greater than 1.5 m/s, which could corrode the pipes.

*5 If the water flow is less than the minimum, the flow error will be activated.
 *6 Tested under BS7208 conditions (Primary flow to cylinder coil 80-82 deg C). Conducted by WRc.
 *7 Calculated from 24h temperature decay at top of the tank from 65degC (ambient temperature approx. 20degC). Tested by WRc.
 *8 Refrigerant of outdoor unit connected to cylinder unit.
 *9 The environment must be frost-free.

1 Specifications

Cylinder unit / Hydrobox

Model name			EHSC-VM6C	EHSC-VM6EC	EHSC-VM9C	EHSC-VM9EC	EHSC-TM9C		
Dimensions	Without package	Height	mm	800	800	800	800	800	
		Width	mm	530	530	530	530	530	
		Depth	mm	360	360	360	360	360	
	With package	Height	mm	990	990	990	990	990	
		Width	mm	600	600	600	600	600	
		Depth	mm	560	560	560	560	560	
Casing	Munsell	-	6.2PB 9/0.9	6.2PB 9/0.9	6.2PB 9/0.9	6.2PB 9/0.9	6.2PB 9/0.9		
	RAL code	-	260 90 05	260 90 05	260 90 05	260 90 05	260 90 05		
	Material	-	Pre-coated metal	Pre-coated metal	Pre-coated metal	Pre-coated metal	Pre-coated metal		
Product weight (empty)		kg	49	44	49	44	49		
Product weight (full)		kg	56	51	56	51	56		
Gross weight		kg	62	57	62	57	62		
Water volume of heating circuit in the unit *1		L	6.1	6.1	6.1	6.1	6.1		
Type of Installation		-	Wall mounted	Wall mounted	Wall mounted	Wall mounted	Wall mounted		
Electrical data	Control board *2 (Including 4 pumps)	Power supply	Ph	~N	~N	~N	~N	~N	
			V	230	230	230	230	230	
			Hz	50	50	50	50	50	
		Input	kW	0.30	0.30	0.30	0.30	0.30	
			Current	A	1.95	1.95	1.95	1.95	1.95
			Breaker	A	10	10	10	10	10
	Booster heater	Power supply	Ph	~N	~N	3~	3~	3~	
			V	230	230	400	400	230	
			Hz	50	50	50	50	50	
		Capacity	kW	2+4	2+4	3+6	3+6	3+6	
		Heater step	-	3	3	3	3	3	
		Current	A	26	26	13	13	23	
	Immersion heater	Power supply	Ph	-	-	-	-	-	
			V	-	-	-	-	-	
			Hz	-	-	-	-	-	
		Capacity	kW	-	-	-	-	-	
		Current	A	-	-	-	-	-	
		Breaker	A	-	-	-	-	-	
	Water circulation pump (Primary circuit)	Type	-	-	-	DC motor	-	-	
			Input (10/20/27.7 L/min)*3	Speed 1	W	18/25/29	18/25/29	18/25/29	18/25/29
				Speed 2	W	25/34/41	25/34/41	25/34/41	25/34/41
				Speed 3	W	34/46/56	34/46/56	34/46/56	34/46/56
				Speed 4	W	45/60/63	45/60/63	45/60/63	45/60/63
				Speed 5	W	57/63/63	57/63/63	57/63/63	57/63/63
Current (10/20/27.7 L/min)*3		Speed 1	A	0.1/0.2/0.2	0.1/0.2/0.2	0.1/0.2/0.2	0.1/0.2/0.2		
		Speed 2	A	0.2/0.3/0.3	0.2/0.3/0.3	0.2/0.3/0.3	0.2/0.3/0.3		
		Speed 3	A	0.3/0.3/0.4	0.3/0.3/0.4	0.3/0.3/0.4	0.3/0.3/0.4		
		Speed 4	A	0.3/0.4/0.5	0.3/0.4/0.5	0.3/0.4/0.5	0.3/0.4/0.5		
		Speed 5	A	0.4/0.5/0.5	0.4/0.5/0.5	0.4/0.5/0.5	0.4/0.5/0.5		
Head difference		0L/min@Speed 5	m	7.0	7.0	7.0	7.0		
	20L/min@Speed 5	m	5.9	5.9	5.9	5.9			
	27.7L/min@Speed 5	m	4.7	4.7	4.7	4.7			
Water circulation pump (DHW circuit)	Input	Speed I	W	-	-	-	-		
		Speed II (Default setting)	W	-	-	-	-		
		Speed III	W	-	-	-	-		
	Current	Speed I	A	-	-	-	-		
		Speed II (Default setting)	A	-	-	-	-		
		Speed III	A	-	-	-	-		
	Flow rate	Speed I	L/min	-	-	-	-		
		Speed II (Default setting)	L/min	-	-	-	-		
		Speed III	L/min	-	-	-	-		
Flow rate	Primary circuit	Max.*4	L/min	27.7	27.7	27.7	27.7		
		Min.*5	L/min	5.0	5.0	5.0	5.0		
Heat exchanger	Refrigerant - Primary circuit water	-	Plate	Plate	Plate	Plate	Plate		
	Primary circuit water - Domestic hot water	-	-	-	-	-	-		
Domestic hot water tank	Volume	L	-	-	-	-	-		
	Material	-	-	-	-	-	-		
	Time to raise DHW tank temp 15 - 65°C *6	min	-	-	-	-	-		
	Time to reheat 70% of DHW tank to 65°C *6	min	-	-	-	-	-		
	Heat loss *7	kWh/24h	-	-	-	-	-		
Expansion vessel (Primary circuit)	Volume	L	10	10	10	10	10		
	Charge pressure	MPa	0.1	0.1	0.1	0.1	0.1		
Safety device	Primary circuit	Control thermistor	°C	1-80	1-80	1-80	1-80		
		Pressure relief valve	MPa	0.3	0.3	0.3	0.3		
		Flow sensor (Min. flow)	L/min	5.0	5.0	5.0	5.0		
		BH manual reset thermostat	°C	90	90	90	90		
		BH thermal Cut Off	°C	121	121	121	121		
	DHW tank	Control thermistor	°C	-	-	-	-		
		IH manual reset thermostat	°C	-	-	-	-		
		Temperature & pressure relief valve	°C	-	-	-	-		
		-	MPa	-	-	-	-		
		-	MPa	-	-	-	-		
Connections	Water	Primary circuit	mm	φ28	φ28	φ28	φ28		
		DHW circuit	mm	-	-	-	-		
	Refrigerant	Gas	mm	φ15.88	φ15.88	φ15.88	φ15.88		
		Liquid	mm	φ9.52	φ9.52	φ9.52	φ9.52		
Refrigerant *8	-	R410A	R410A	R410A	R410A	R410A			
Guaranteed operating range *9	Ambient	°C	0-35	0-35	0-35	0-35			
		%RH	≤80	≤80	≤80	≤80			
	Outdoor temperature	Heating	°C	-	-	-	-		
Operating range	Heating	Room temperature	°C	10-30	10-30	10-30	10-30		
		Flow temperature	°C	25-60	25-60	25-60	25-60		
	Cooling	Room temperature	°C	-	-	-	-		
		Flow temperature	°C	-	-	-	-		
	DHW	°C	-	-	-	-	-		
		Legionella prevention	°C	-	-	-	-		
Sound pressure level			dB(A)	28	28	28	28		
Sound power level			dB(A)	40	40	40	40		

*1 Volume of sanitary water circuit, primary DHW circuit (from 3-way valve to confluent point with Heating circuit), piping to Expansion vessel, and Expansion vessel is not included in this value.
 *2 When powered from independent source.
 *3 Allowable flow rate range differs depending on connected outdoor unit. Please refer to section 4.2.
 *4 If the water flow rate exceeds maximum, the flow speed will be greater than 1.5 m/s, which could corrode the pipes.

*5 If the water flow is less than the minimum, the flow error will be activated.
 *6 Tested under BS7206 conditions (Primary flow to cylinder coil 80-82 deg C). Conducted by WRc.
 *7 Calculated from 24h temperature decay at top of the tank from 65degC (ambient temperature approx. 20degC). Tested by WRc.
 *8 Refrigerant of outdoor unit connected to cylinder unit.
 *9 The environment must be frost-free.

1 Specifications

Cylinder unit / Hydrobox

Cylinder / Hydrobox

Model name			ERSD-VM2C	ERSC-MEC	ERSC-VM2C	EHSD-YM9C	EHSD-MC	EHPX-VM2C	EHPX-YM9C	EHPX-VM6C			
Dimensions	Without package	Height	mm	800	800	800	800	800	800	800			
		Width	mm	530	530	530	530	530	530	530			
		Depth	mm	360	360	360	360	360	360	360			
	With package	Height	mm	990	990	990	990	990	990	990			
		Width	mm	600	600	600	600	600	600	600			
		Depth	mm	560	560	560	560	560	560	560			
Casing	Munsell	-	6.2PB 9/0.9	6.2PB 9/0.9	6.2PB 9/0.9	6.2PB 9/0.9	6.2PB 9/0.9	6.2PB 9/0.9	6.2PB 9/0.9	6.2PB 9/0.9			
	RAL code	-	260 90 05	260 90 05	260 90 05	260 90 05	260 90 05	260 90 05	260 90 05	260 90 05			
	Material	-	Pre-coated metal	Pre-coated metal	Pre-coated metal	Pre-coated metal	Pre-coated metal	Pre-coated metal	Pre-coated metal	Pre-coated metal			
Product weight (empty)	kg	45	43	49	45	43	37	38	38				
Product weight (full)	kg	51	50	56	51	49	42	43	43				
Gross weight	kg	58	56	62	58	56	50	51	51				
Water volume of heating circuit in the unit *1	L	5.5	6.4	6.4	5.2	5.2	4.5	4.5	4.5				
Type of Installation	-	Wall mounted	Wall mounted	Wall mounted	Wall mounted	Wall mounted	Wall mounted	Wall mounted	Wall mounted				
Electrical data	Control board *2 (Including 4 pumps)	Power supply	Ph	~N	~N	~N	~N	~N	~N	~N			
			V	230	230	230	230	230	230	230			
			Hz	50	50	50	50	50	50	50			
		Input	kW	0.30	0.30	0.30	0.30	0.30	0.30	0.30			
		Current	A	1.95	1.95	1.95	1.95	1.95	1.95	1.95			
		Breaker	A	10	10	10	10	10	10	10			
	Booster heater	Power supply	Ph	~N	-	~N	3~	-	~N	3~	~N		
			V	230	-	230	400	-	230	400	230		
			Hz	50	-	50	50	-	50	50	50		
		Capacity	kW	2	-	2	3+6	-	2	3+6	2+4		
		Heater step	-	1	-	1	3	-	1	3	3		
		Current	A	9	-	9	13	-	9	13	26		
	Breaker	A	16	-	16	16	-	16	16	32			
	Immersion heater	Power supply	Ph	-	-	-	-	-	-	-	-		
			V	-	-	-	-	-	-	-	-		
			Hz	-	-	-	-	-	-	-	-		
		Capacity	kW	-	-	-	-	-	-	-	-		
		Current	A	-	-	-	-	-	-	-	-		
		Breaker	A	-	-	-	-	-	-	-	-		
	Water circulation pump (Primary circuit)	Type	-	DC motor									
			Input (10/20/27.7 L/min)*3	Speed 1	W	19/26/32	19/26/32	19/26/32	18/25/29	18/25/29	18/25/29	18/25/29	18/25/29
				Speed 2	W	26/37/45	26/37/45	26/37/45	25/34/41	25/34/41	25/34/41	25/34/41	25/34/41
				Speed 3	W	34/49/60	34/49/60	34/49/60	34/46/56	34/46/56	34/46/56	34/46/56	34/46/56
				Speed 4	W	45/65/70	45/65/70	45/65/70	45/60/63	45/60/63	45/60/63	45/60/63	45/60/63
Speed 5				W	57/70/70	57/70/70	57/70/70	57/63/63	57/63/63	57/63/63	57/63/63	57/63/63	
Current (10/20/27.7 L/min)*3		Speed 1	A	0.2/0.2/0.3	0.2/0.2/0.3	0.2/0.2/0.3	0.1/0.2/0.2	0.1/0.2/0.2	0.1/0.2/0.2	0.1/0.2/0.2	0.1/0.2/0.2		
Speed 2		A	0.2/0.3/0.4	0.2/0.3/0.4	0.2/0.3/0.4	0.2/0.3/0.3	0.2/0.3/0.3	0.2/0.3/0.3	0.2/0.3/0.3	0.2/0.3/0.3			
Speed 3		A	0.3/0.4/0.5	0.3/0.4/0.5	0.3/0.4/0.5	0.3/0.3/0.4	0.3/0.3/0.4	0.3/0.3/0.4	0.3/0.3/0.4	0.3/0.3/0.4			
Speed 4		A	0.4/0.5/0.6	0.4/0.5/0.6	0.4/0.5/0.6	0.3/0.4/0.5	0.3/0.4/0.5	0.3/0.4/0.5	0.3/0.4/0.5	0.3/0.4/0.5			
Speed 5		A	0.5/0.6/0.6	0.5/0.6/0.6	0.5/0.6/0.6	0.4/0.5/0.5	0.4/0.5/0.5	0.4/0.5/0.5	0.4/0.5/0.5	0.4/0.5/0.5			
Head difference		0L/min@Speed 5	m	7.0	7.0	7.0	7.0	7.0	7.0	7.0	7.0		
	20L/min@Speed 5	m	5.9	5.9	5.9	5.9	5.9	5.9	5.9	5.9			
	27.7L/min@Speed 5	m	4.7	4.7	4.7	4.7	4.7	4.7	4.7	4.7			
Water circulation pump (DHW circuit)	Input	Speed I	W	-	-	-	-	-	-	-			
		Speed II (Default setting)	W	-	-	-	-	-	-	-			
		Speed III	W	-	-	-	-	-	-	-			
	Current	Speed I	A	-	-	-	-	-	-	-			
		Speed II (Default setting)	A	-	-	-	-	-	-	-			
		Speed III	A	-	-	-	-	-	-	-			
	Flow rate	Speed I	L/min	-	-	-	-	-	-	-			
		Speed II (Default setting)	L/min	-	-	-	-	-	-	-			
		Speed III	L/min	-	-	-	-	-	-	-			
Flow rate	Primary circuit	Max.*4	L/min	27.7	27.7	27.7	27.7	27.7	27.7	27.7			
		Min.*5	L/min	5.0	5.0	5.0	5.0	5.0	5.0	5.0			
Heat exchanger	Refrigerant - Primary circuit water	-	Plate	Plate	Plate	Plate	Plate	-	-	-			
	Primary circuit water - Domestic hot water	-	-	-	-	-	-	-	-	-			
Domestic hot water tank	Volume	L	-	-	-	-	-	-	-	-			
	Material	-	-	-	-	-	-	-	-	-			
	Time to raise DHW tank temp 15 - 65°C *6	min	-	-	-	-	-	-	-	-			
	Time to reheat 70% of DHW tank to 65°C *6	min	-	-	-	-	-	-	-	-			
	Heat loss *7	kWh/24h	-	-	-	-	-	-	-	-			
Expansion vessel (Primary circuit)	Volume	L	10	-	10	10	10	10	10	10			
	Charge pressure	MPa	0.1	-	0.1	0.1	0.1	0.1	0.1	0.1			
Safety device	Primary circuit	Control thermistor	°C	1~80	1~80	1~80	1~80	1~80	1~80	1~80			
		Pressure relief valve	MPa	0.3	0.3	0.3	0.3	0.3	0.3	0.3			
		Flow sensor (Min. flow)	L/min	5.0	5.0	5.0	5.0	5.0	5.0	5.0			
		BH manual reset thermostat	°C	90	-	90	90	-	90	90			
		BH thermal Cut Off	°C	121	-	121	121	-	121	121			
	DHW tank	Control thermistor	°C	-	-	-	-	-	-	-			
		IH manual reset thermostat	°C	-	-	-	-	-	-	-			
		Temperature & pressure relief valve	°C	-	-	-	-	-	-	-			
			MPa	-	-	-	-	-	-	-			
			MPa	-	-	-	-	-	-	-			
Connections	Water	Primary circuit	mm	G1-A	G1-A	G1-A	φ28	φ28	φ28	φ28			
		DHW circuit	mm	-	-	-	-	-	-	-			
	Refrigerant	Gas	mm	φ12.7	φ15.88	φ15.88	φ12.7	φ12.7	-	-			
		Liquid	mm	φ6.35	φ9.52	φ9.52	φ6.35	φ6.35	-	-			
Refrigerant *8	-	R410A	R410A	R410A	R410A	R410A	R410A	R410A	R410A				
Guaranteed operating range *9	Ambient	°C	0-35	0-35	0-35	0-35	0-35	0-35	0-35				
	%RH	≤80	≤80	≤80	≤80	≤80	≤80	≤80	≤80				
Operating range	Heating	Room temperature	°C	10-30	10-30	10-30	10-30	10-30	10-30	10-30			
		Flow temperature	°C	25-60	25-60	25-60	25-60	25-60	25-60	25-60			
	Cooling	Room temperature	°C	-	-	-	-	-	-	-			
		Flow temperature	°C	5-25	5-25	5-25	-	-	-	-			
	DHW	°C	-	-	-	-	-	-	-	-			
		Legionella prevention	°C	-	-	-	-	-	-	-			
Sound pressure level	dB(A)	28	28	28	28	28	28	28	28				
Sound power level	dB(A)	40	40	40	40	40	40	40	40				

*1 Volume of sanitary water circuit, primary DHW circuit (from 3-way valve to confluent point with Heating circuit), piping to Expansion vessel, and Expansion vessel is not included in this value.
 *2 When powered from independent source.
 *3 Allowable flow rate range differs depending on connected outdoor unit. Please refer to section 4.2.
 *4 If the water flow rate exceeds maximum, the flow speed will be greater than 1.5 m/s, which could corrode the pipes.
 *5 If the water flow is less than the minimum, the flow error will be activated.
 *6 Tested under BS7206 conditions (Primary flow to cylinder coil 80-82 deg C). Conducted by WRc.

*7 Calculated from 24h temperature decay at top of the tank from 65degC (ambient temperature approx. 20degC). Tested by WRc.
 *8 Refrigerant of outdoor unit connected to cylinder unit.
 *9 The environment must be frost-free.
 *10 Cooling mode is not available in low outdoor temperature.
 If you use our system in cooling mode at the low ambient temperature (10°C or below), there are some risks of plate heat exchanger breaking by frozen water.

1 Specifications

Cylinder unit / Hydrobox

Model name				EHSE-YM9EC	EHSE-MEC	ERSE-YM9EC	ERSE-MEC	
Dimensions	Without package	Height	mm	950	950	950	950	
		Width	mm	600	600	600	600	
		Depth	mm	360	360	360	360	
	With package	Height	mm	1150	1150	1150	1150	
		Width	mm	690	690	690	690	
		Depth	mm	560	560	560	560	
Casing	Munsell	-	6.2PB 9/0.9	6.2PB 9/0.9	6.2PB 9/0.9	6.2PB 9/0.9		
	RAL code	-	260 90 05	260 90 05	260 90 05	260 90 05		
	Material	-	Pre-coated metal	Pre-coated metal	Pre-coated metal	Pre-coated metal		
Product weight (empty)		kg	62	60	63	61		
Product weight (full)		kg	72	70	73	71		
Gross weight		kg	77	75	78	76		
Water volume of heating circuit in the unit *1		L	10	10	10	10		
Type of Installation		-	Wall mounted	Wall mounted	Wall mounted	Wall mounted		
Electrical data	Control board *2 (Including 4 pumps)	Power supply	Ph	~N	~N	~N	~N	
			V	230	230	230	230	
			Hz	50	50	50	50	
		Input	kW	0.34	0.34	0.34	0.34	
		Current	A	2.56	2.56	2.56	2.56	
		Breaker	A	10	10	10	10	
	Booster heater	Power supply	Ph	3~	-	3~	-	
			V	400	-	400	-	
			Hz	50	-	50	-	
		Capacity	kW	3+6	-	3+6	-	
		Heater step	-	3	-	3	-	
		Current	A	13	-	13	-	
	Immersion heater	Power supply	Ph	-	-	-	-	
			V	-	-	-	-	
			Hz	-	-	-	-	
		Capacity	kW	-	-	-	-	
		Current	A	-	-	-	-	
		Breaker	A	-	-	-	-	
Water circulation pump (Primary circuit)	Type	DC motor						
		Input (26/45/61.5 L/min)	Speed 1	W	31/37/38	31/37/38	31/37/38	31/37/38
			Speed 2	W	51/63/68	51/63/68	51/63/68	51/63/68
			Speed 3	W	75/94/105	75/94/105	75/94/105	75/94/105
			Speed 4	W	106/134/153	106/134/153	106/134/153	106/134/153
			Speed 5	W	148/180/180	148/180/180	148/180/180	148/180/180
	Current (26/45/61.5 L/min)	Speed 1	A	0.3/0.3/0.3	0.3/0.3/0.3	0.3/0.3/0.3	0.3/0.3/0.3	
		Speed 2	A	0.4/0.5/0.5	0.4/0.5/0.5	0.4/0.5/0.5	0.4/0.5/0.5	
		Speed 3	A	0.6/0.7/0.8	0.6/0.7/0.8	0.6/0.7/0.8	0.6/0.7/0.8	
		Speed 4	A	0.9/1.1/1.2	0.9/1.1/1.2	0.9/1.1/1.2	0.9/1.1/1.2	
		Speed 5	A	1.2/1.4/1.4	1.2/1.4/1.4	1.2/1.4/1.4	1.2/1.4/1.4	
	Head difference	0L/min@Speed 5	m	12.7	12.7	12.7	12.7	
45L/min@Speed 5		m	11	11	11	11		
61.5L/min@Speed 5		m	9.5	9.5	9.5	9.5		
Water circulation pump (DHW circuit)	Input	Speed I	W	-	-	-	-	
		Speed II (Default setting)	W	-	-	-	-	
		Speed III	W	-	-	-	-	
	Current	Speed I	A	-	-	-	-	
		Speed II (Default setting)	A	-	-	-	-	
		Speed III	A	-	-	-	-	
	Flow rate	Speed I	L/min	-	-	-	-	
		Speed II (Default setting)	L/min	-	-	-	-	
		Speed III	L/min	-	-	-	-	
Flow rate	Primary circuit	Max.*3	L/min	61.5	61.5	61.5	61.5	
	Min.*4	L/min	5.0	5.0	5.0	5.0		
Heat exchanger	Refrigerant - Primary circuit water	-	Plate	Plate	Plate	Plate		
	Primary circuit water - Domestic hot water	-	-	-	-	-		
Domestic hot water tank	Volume	L	-	-	-	-		
	Material	-	-	-	-	-		
	Time to raise DHW tank temp 15 - 65°C *5	min	-	-	-	-		
	Time to reheat 70% of DHW tank to 65°C *5	min	-	-	-	-		
	Heat loss *6	kWh/24h	-	-	-	-		
Expansion vessel (Primary circuit)	Volume	L	-	-	-	-		
	Charge pressure	MPa	-	-	-	-		
Safety device	Primary circuit	Control thermistor	°C	1-80	1-80	1-80	1-80	
		Pressure relief valve	MPa	0.3	0.3	0.3	0.3	
		Flow sensor (Min. flow)	L/min	5.0	5.0	5.0	5.0	
		BH manual reset thermostat	°C	90	-	90	-	
		BH thermal Cut Off	°C	121	-	121	-	
	DHW tank	Control thermistor	°C	-	-	-	-	
		IH manual reset thermostat	°C	-	-	-	-	
		Temperature & pressure relief valve	°C	-	-	-	-	
			MPa	-	-	-	-	
			-	-	-	-	-	
Connections	Water	Primary circuit	-	G1-1/2B	G1-1/2B	G1-1/2B	G1-1/2B	
		DHW circuit	-	-	-	-	-	
	Refrigerant	Gas	mm	φ25.4(Brazing)	φ25.4(Brazing)	φ25.4(Brazing)	φ25.4(Brazing)	
		Liquid	mm	φ9.52	φ9.52	φ9.52	φ9.52	
Refrigerant *7	Guaranteed operating range *8		°C	0-35	0-35	0-35	0-35	
			%RH	≤80	≤80	≤80	≤80	
Operating range	Outdoor temperature	Heating	°C	See outdoor unit spec table				
		Cooling	°C	-	-	10-46 (*9)	-	
	Heating	Room temperature	°C	10-30	10-30	10-30	10-30	
		Flow temperature	°C	25-60	25-60	25-60	25-60	
	Cooling	Room temperature	°C	-	-	-	-	
		Flow temperature	°C	-	-	5-25	5-25	
DHW		°C	-	-	-	-		
Legionella prevention		°C	-	-	-	-		
Sound pressure level		dB(A)	30	30	30	30		
Sound power level		dB(A)	45	45	45	45		

*1 Volume of sanitary water circuit, primary DHW circuit (from 3-way valve to confluent point with Heating circuit), piping to Expansion vessel, and Expansion vessel is not included in this value.
 *2 When powered from independent source.
 *3 If the water flow rate exceeds maximum, the flow speed will be greater than 1.5 m/s, which could corrode the pipes.
 *4 If the water flow is less than the minimum, the flow error will be activated.
 *5 Tested under BS7206 conditions(Primary flow to cylinder coil 80-82 deg C). Conducted by WRc.

*6 Calculated from 24h temperature decay at top of the tank from 65degC (ambient temperature approx. 20degC). Tested by WRc.
 *7 Refrigerant of outdoor unit connected to cylinder unit.
 *8 The environment must be frost-free.
 *9 Cooling mode is not available in low outdoor temperature. If you use our system in cooling mode at the low ambient temperature (10°C or below), there are some risks of plate heat exchanger breaking by frozen water.

<Unit: mm>

2.1 Cylinder unit

<E**T20*-M**C>

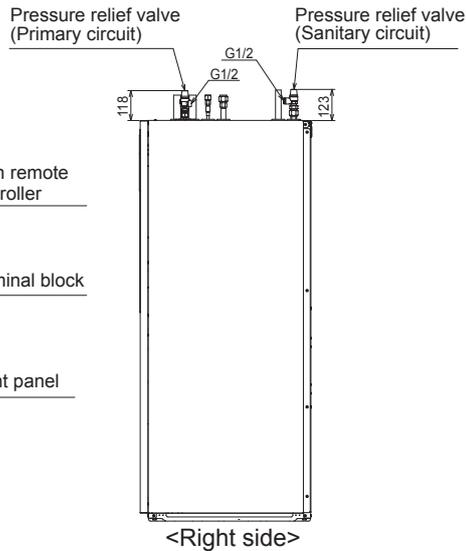
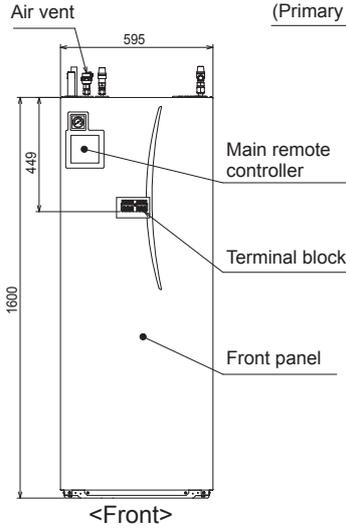
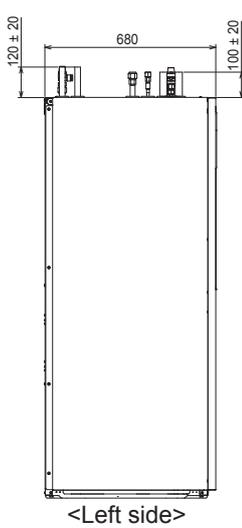

<ERST20*-M**C>

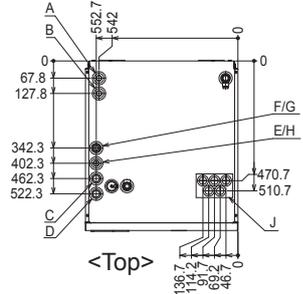
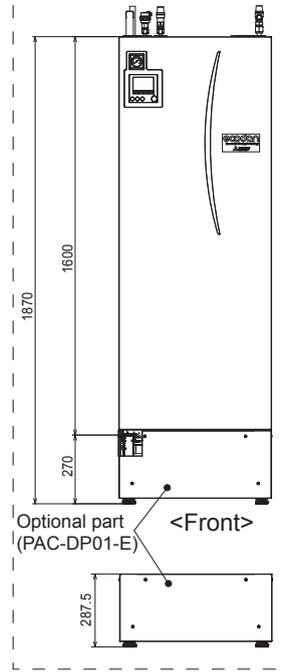

<EH*T20*-MHCW>

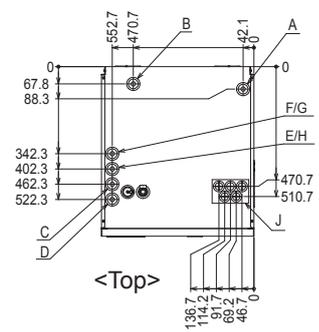
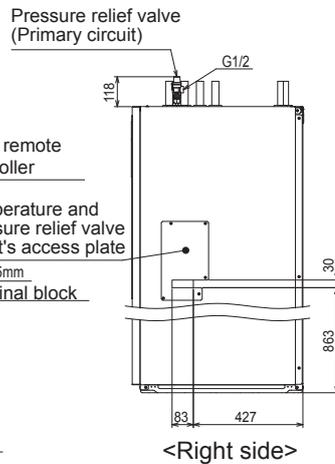
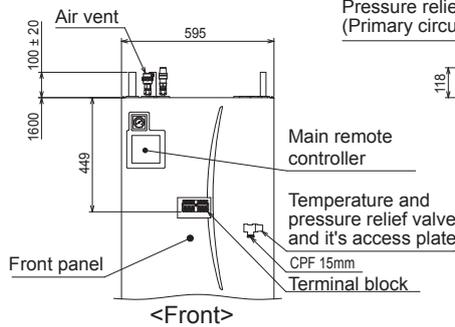
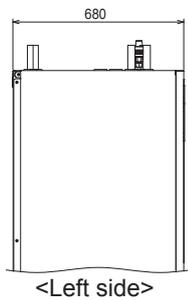

Letter	Pipe description	Connection size/type
A	DHW outlet connection	22 mm/Compression
B	Cold water inlet connection	22 mm/Compression
C	Space heating/cooling return connection	28 mm/Compression
D	Space heating/cooling flow connection	28 mm/Compression
E	Flow from heat pump connection (No plate heat exchanger)	28 mm/Compression
F	Return to heat pump connection (No plate heat exchanger)	28 mm/Compression
G	Refrigerant (GAS) (With plate heat exchanger)	12.7 mm/Flare (E*ST20D-*) 15.88 mm/Flare (E*ST20C-*)
H	Refrigerant (LIQUID) (With plate heat exchanger)	6.35 mm/Flare (E*ST20D-*) 9.52 mm/Flare (E*ST20C-*)
J	Electrical cable inlets 	For inlets ①, ② and ③, run low-voltage wires including external input wires and thermistor wires. For inlets ④ and ⑤, run high-voltage wires including power cable, indoor-outdoor cable, and external output wires. *For a wireless receiver (option) cable and ecodan Wi-Fi interface (option) cable, use inlet ①.

<Table 2.1.1>

<Unit: mm>

2.2 Hydrobox

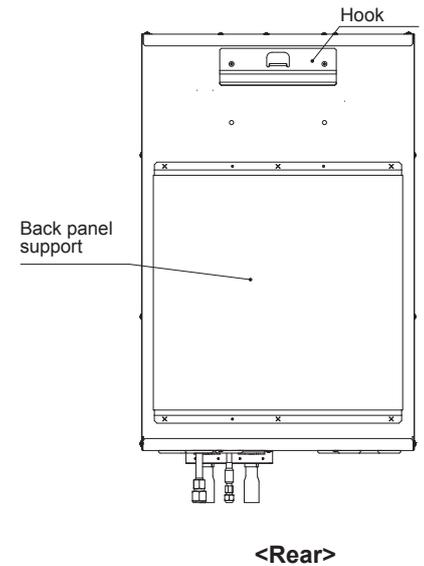
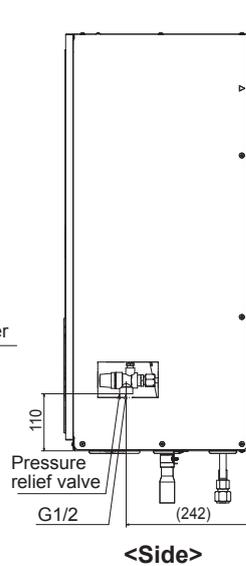
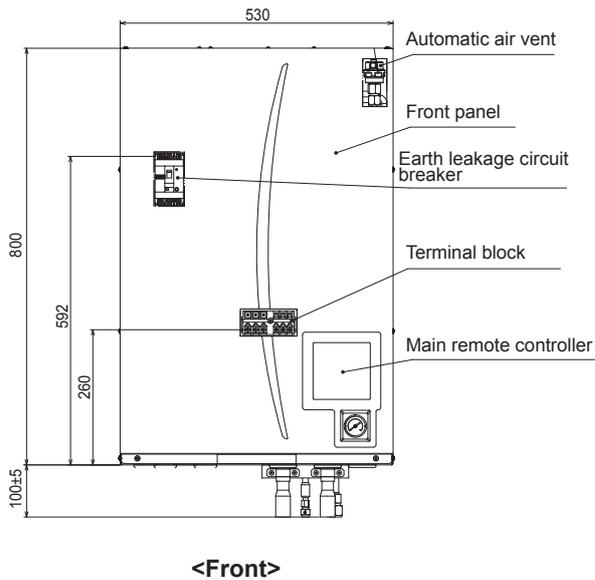

Cylinder / Hydrobox

<EHSC/D> (Split model system for heating)

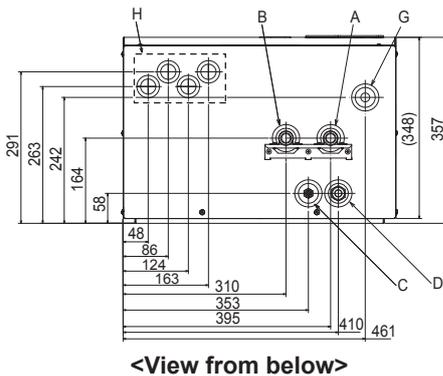

<ERSC/D> (Split model system for heating and cooling)

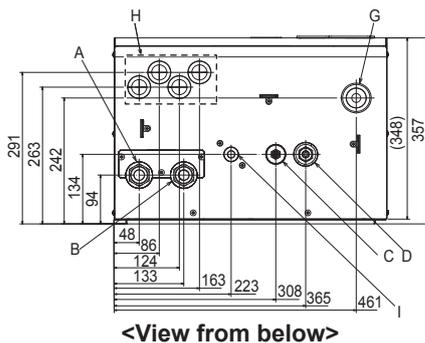

<EHPX> (Packaged model system for heating)

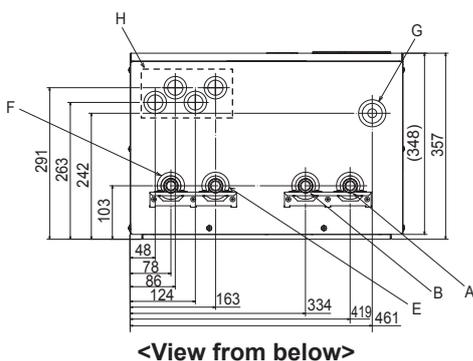

Letter	Pipe description	Connection size/type
A	Space heating/Indirect DHW tank (primary) return connection	28 mm/Compression (EHS*-*and EHPX-*) G1 nut (ERS*-*)
B	Space heating/Indirect DHW tank (primary) flow connection	28 mm/Compression (EHS*-*and EHPX-*) G1 nut (ERS*-*)
C	Refrigerant (Liquid)	6.35 mm/Flare (E*SD-*) 9.52 mm/Flare (E*SC-*)
D	Refrigerant (Gas)	12.7 mm/Flare (E*SD-*) 15.88 mm/Flare (E*SC-*)
E	Flow connection from heat pump	28 mm/Compression (EHPX-*)
F	Return connection to heat pump	28 mm/Compression (EHPX-*)
G	Discharge pipe (by installer) from pressure relief valve	G1/2" female (valve port within hydrobox casing)
H	Electrical cable inlets ① ② ③ ④	For inlets ① and ②, run high-voltage wires including power cable, indoor-outdoor cable, and external output wires. For inlets ③ and ④, run low-voltage wires including external input wires and thermistor wires. For a wireless receiver (option) cable, use inlet ④.
I	Drain socket	O.D. ø20

<Table 2.2.1>

2 Outlines and dimensions

Cylinder unit / Hydrobox

<EHSE> (Split model system for heating)

<Unit: mm>

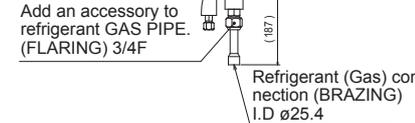
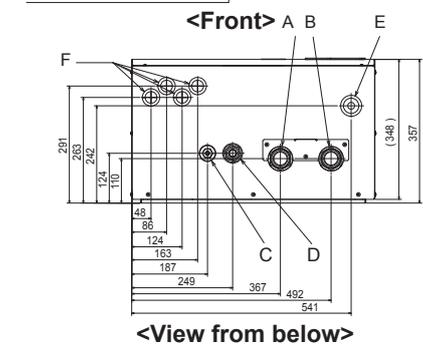
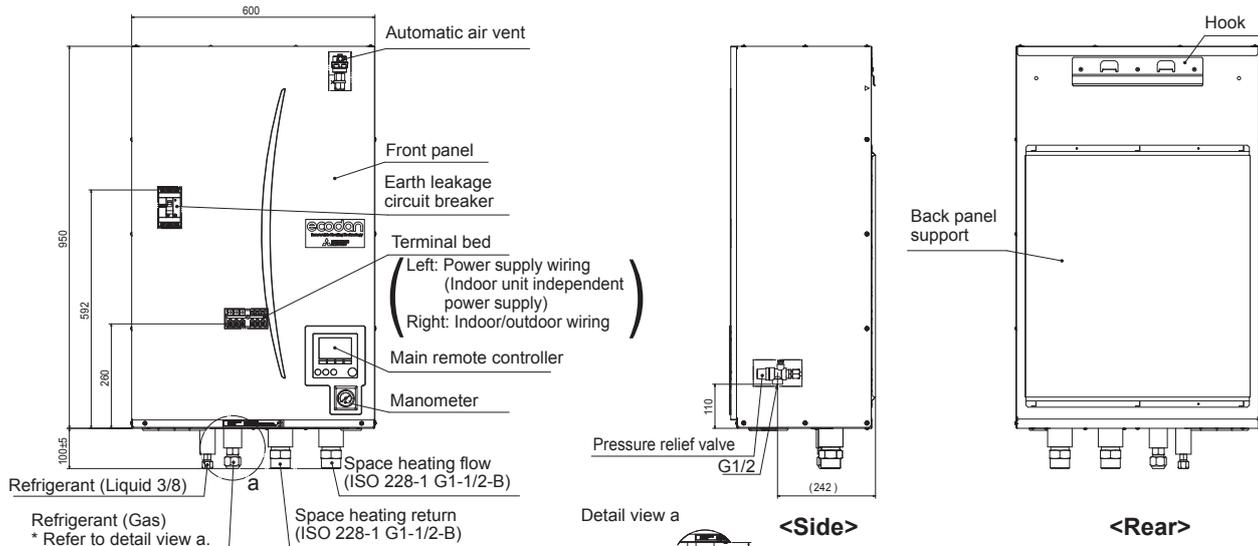

Letter	Pipe description	Connection size/type
A	Space heating/Indirect DHW tank (primary) return connection	G1-1/2 -B
B	Space heating/Indirect DHW tank (primary) flow connection	G1-1/2 -B
C	Refrigerant (Liquid)	9.52 mm/Flare
D	Refrigerant (Gas)	Brazing connection I.D. ø25.4
E	Discharge pipe (by installer) from pressure relief valve	G1/2 female (valve port within hydrobox casing)
F	Electrical cable inlets	For inlets ① and ②, run high-voltage wires including power cable, indoor-outdoor cable, and external output wires. For inlets ③ and ④, run low-voltage wires including external input wires and thermistor wires. For a wireless receiver (option) cable, use inlet ④.
G	Drain socket	O.D. ø20

<ERSE> (Split model system for heating and cooling)

<Table 2.2.2>

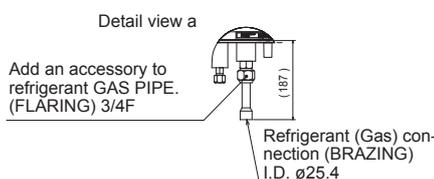
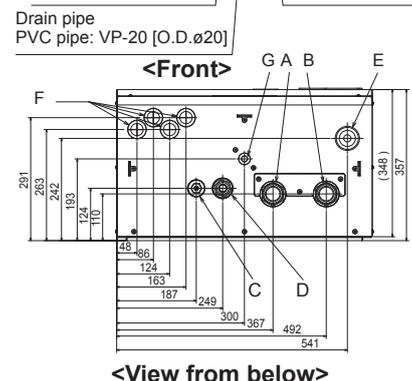
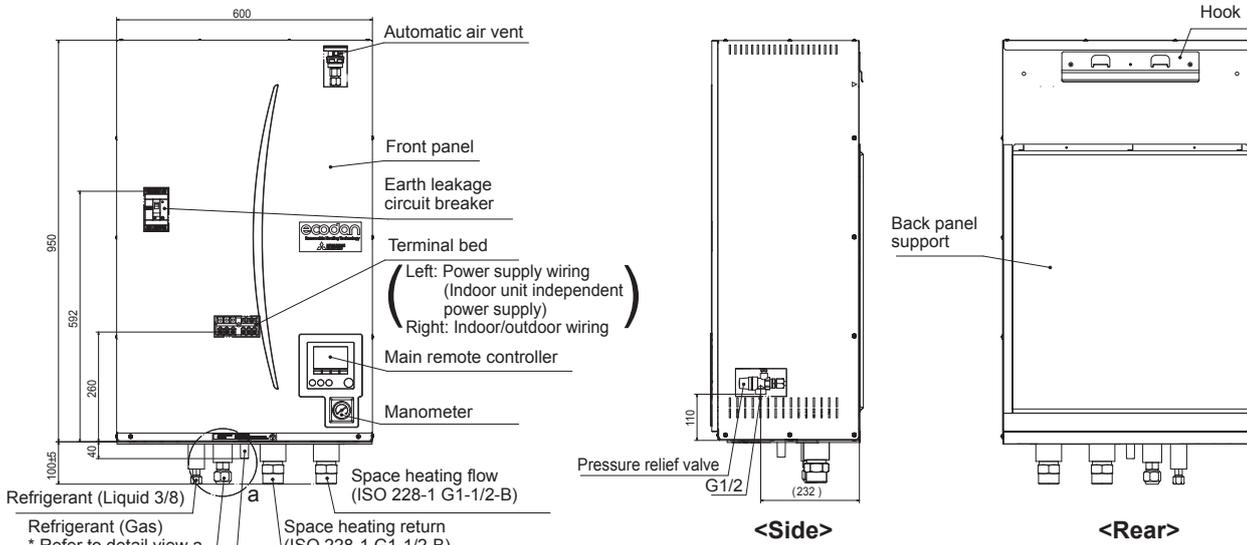

2.3 System configuration

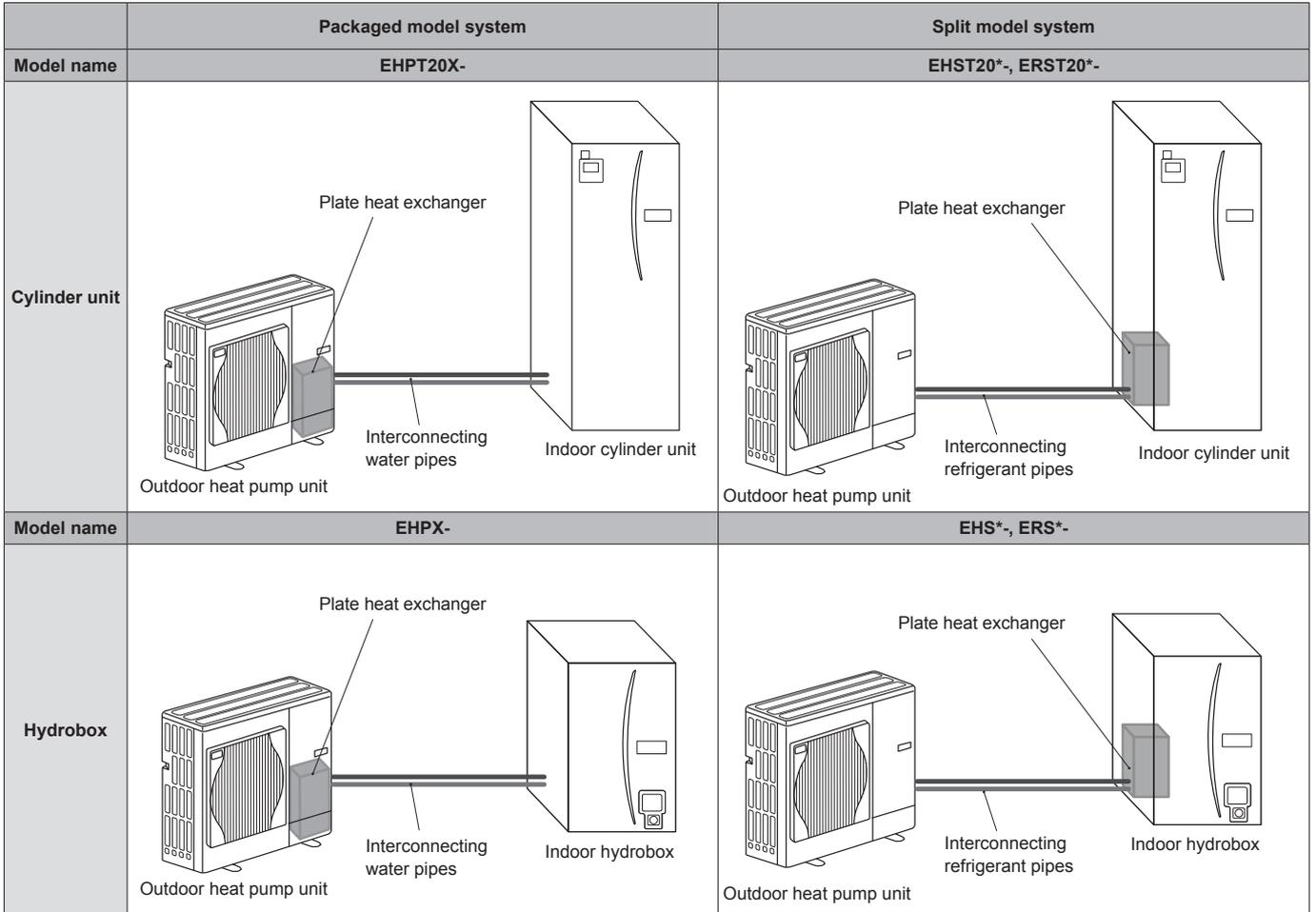

Cylinder / Hydrobox

2.4 Service access diagrams

■ Cylinder unit

Service access	
Parameter	Dimension (mm)
a	300*
b	150
c (distance behind unit not visible in Figure 2.4.1>	10
d	500

Sufficient space MUST be left for the provision of discharge pipework as detailed in National and Local Building Regulations.

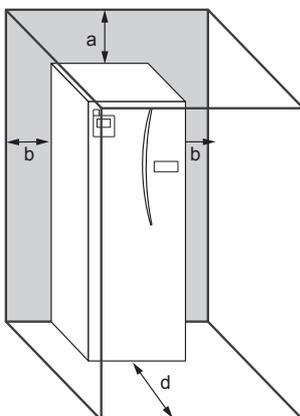

<Figure 2.4.1>
Service access

* An additional 300 mm of space (total 600 mm) is required, when installing the optional 2-zone kit (PAC-TZ01-E) on top of the cylinder unit.

The cylinder unit must be located indoors and in a frost-free environment, for example in a utility room, to minimise heat loss from stored water.

■ Hydrobox

Service access	
Parameter	Dimension (mm)
a	200
b	150
c	500
d	500

Sufficient space MUST be left for the provision of discharge pipework as detailed in National and Local building regulations.

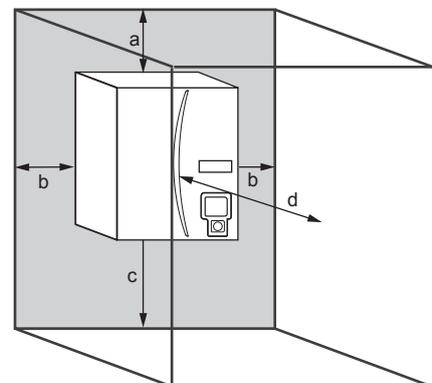

<Figure 2.4.2>
Service access

The hydrobox must be located indoors and in a frost-free environment, for example in a utility room.

EHST20C-VM6C, EHST20C-VM6EC, EHPT20X-VM6C

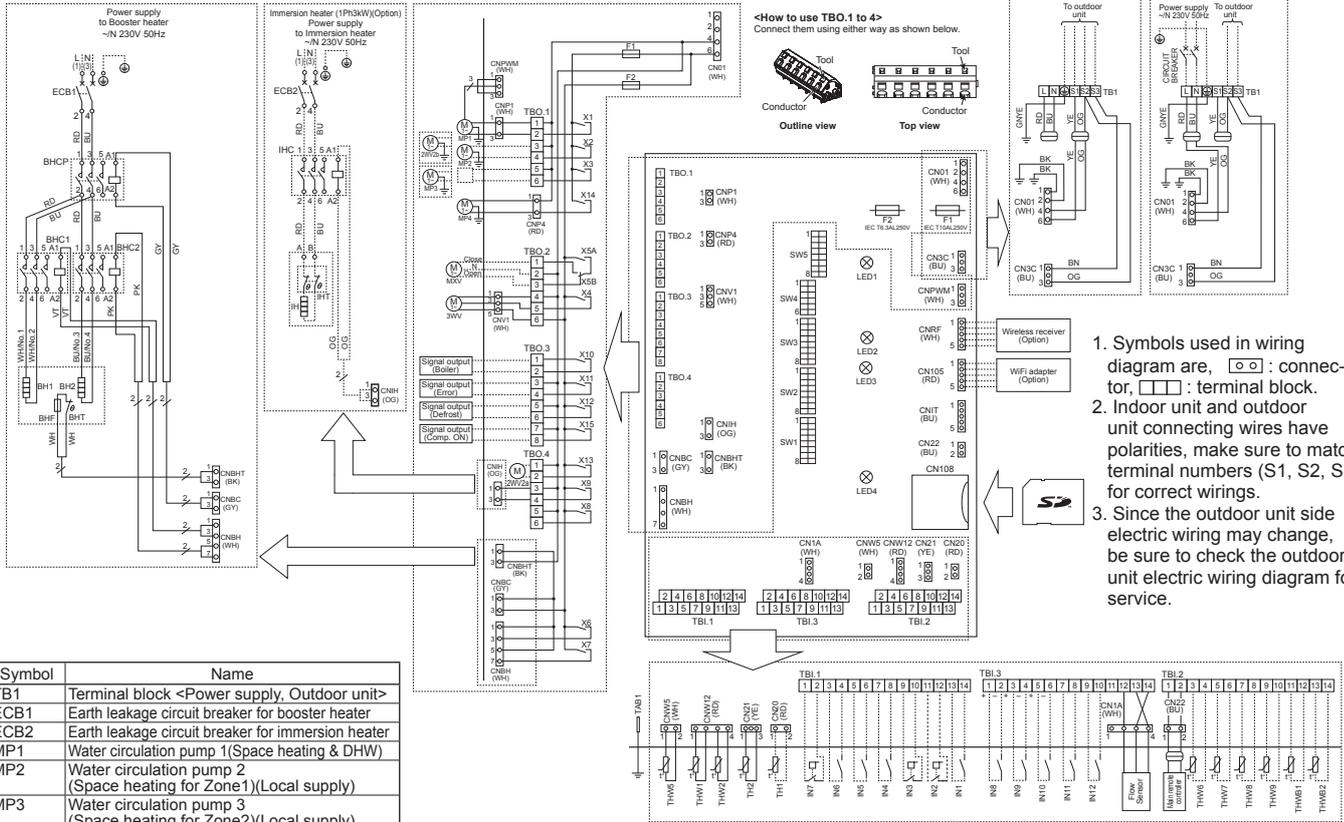

Symbol	Name
TB1	Terminal block <Power supply, Outdoor unit>
ECB1	Earth leakage circuit breaker for booster heater
ECB2	Earth leakage circuit breaker for immersion heater
MP1	Water circulation pump 1 (Space heating & DHW)
MP2	Water circulation pump 2 (Space heating for Zone1)(Local supply)
MP3	Water circulation pump 3 (Space heating for Zone2)(Local supply)
MP4	Water circulation pump 4 (DHW)
3WV	3-way valve
2WV2a	2-way valve (For Zone 1)(Local supply)
2WV2b	2-way valve (For Zone 2)(Local supply)
MXV	Mixing valve (Local supply)
BHT	Thermostat for booster heater
BHF	Thermal fuse for booster heater
BH1	Booster heater 1
BH2	Booster heater 2
BHC1	Contactor for booster heater 1
BHC2	Contactor for booster heater 2
BHCP	Contactor for booster heater protection
IHT	Thermostat (fixed temp.) for immersion heater
IH	Immersion heater
IHC	Contactor for immersion heater
TH1	Thermistor (Room temp.)(Option)
TH2	Thermistor (Ref. liquid temp.)(Option)
THW1	Thermistor (Flow water temp.)(Option)
THW2	Thermistor (Return water temp.)(Option)
THW5	Thermistor (DHW tank water temp.)(Option)
THW6	Thermistor (Zone1 flow temp.)(Option)
THW7	Thermistor (Zone1 return temp.)(Option)
THW8	Thermistor (Zone2 flow temp.)(Option)
THW9	Thermistor (Zone2 return temp.)(Option)
THWB1	Thermistor (Boiler flow temp.)(Option)
THWB2	Thermistor (Boiler return temp.)(Option)
IN1	Room thermostat 1 (Local supply)
IN2	Flow switch 1 (Local supply)
IN3	Flow switch 2 (Local supply)
IN4	Demand control (Local supply)
IN5	Outdoor thermostat (Local supply)
IN6	Room thermostat 2 (Local supply)
IN7	Flow switch 3 (Local supply)
IN8	Electric energy meter 1 (Local supply)
IN9	Electric energy meter 2 (Local supply)
IN10	Heat meter (Local supply)
IN11	Smart grid ready input (Local supply)
IN12	Smart grid ready input (Local supply)
IN1A	Flow sensor
FLOW TEMP. CONTROLLER (FTC5)	
TBO.1-4	Terminal block <Outputs>
TBI.1-3	Terminal block <Signal Inputs, Thermistor>
F1	Fuse (IEC T6.3AL250V)
F2	Fuse (IEC T6.3AL250V)
SW1-5	DIP switch *See 3.1.2 DIP switch functions.
X1-15	Relay
LED1	Power supply (FTC5)
LED2	Power supply (Main remote controller)
LED3	Communication (FTC5-Outdoor unit)
LED4	Reading or writing data to SD card
CNPWM	Pump speed control signal for MP1
CN108	SD card connector

Table 1 Signal Inputs

Name	Terminal block	Connector	Item	OFF (Open)	ON (Short)
IN1	TBI.1 13-14	—	Room thermostat 1 input *1	Refer to SW2-1 in <3.1.2 DIP switch functions>.	
IN2	TBI.1 11-12	—	Flow switch 1 input	Refer to SW2-2 in <3.1.2 DIP switch functions>.	
IN3	TBI.1 9-10	—	Flow switch 2 input (Zone1)	Refer to SW3-2 in <3.1.2 DIP switch functions>.	
IN4	TBI.1 7-8	—	Demand control input	Normal Heat source OFF/ Boiler operation *3	
IN5	TBI.1 5-6	—	Outdoor thermostat input *2	Standard operation Heater operation Boiler operation *3	
IN6	TBI.1 3-4	—	Room thermostat 2 input *1	Refer to SW3-1 in <3.1.2 DIP switch functions>.	
IN7	TBI.1 1-2	—	Flow switch 3 input (Zone2)	Refer to SW3-3 in <3.1.2 DIP switch functions>.	
IN8	TBI.3 1-2	—	Electric energy meter 1	Refer to installation manual.	
IN9	TBI.3 3-4	—	Electric energy meter 2		
IN10	TBI.3 5-6	—	Heat meter		
IN11	TBI.3 7-8	—	Smart grid ready input		
IN12	TBI.3 9-10	—	Smart grid ready input		
IN1A	TBI.3 12-14	CN1A	Flow sensor		

- *1. Set the ON/OFF cycle time of the room thermostat for 10 minutes or more; otherwise the compressor may be damaged.
- *2. If using outdoor thermostat for controlling operation of heaters, the lifetime of the heaters and related parts may be reduced.
- *3. To turn on the boiler operation, use the main remote controller to select "Boiler" in "External input setting" screen in the service menu.

Table 2 Outputs

Name	Terminal block	Connector	Item	OFF	ON
OUT1	TBO.1 1-2	CNP1	Water circulation pump 1 output (Space heating & DHW)	OFF	ON
OUT2	TBO.1 3-4	—	Water circulation pump 2 output (Space heating for Zone1)	OFF	ON
OUT3	TBO.1 5-6	—	Water circulation pump 3 output (Space heating for Zone2) *1	OFF	ON
OUT4	TBO.2 4-6	CNV1	3-way valve output	Heating	DHW
OUT5	TBO.2 2-3	—	Mixing valve output *1	Stop	Close Open
OUT6	—	CNBH 1-3	Booster heater 1 output	OFF	ON
OUT7	—	CNBH 5-7	Booster heater 2 output	OFF	ON
OUT9	TBO.4 3-4	CNIH	Immersion heater output	OFF	ON
OUT10	TBO.3 1-2	—	Boiler output	OFF	ON
OUT11	TBO.3 3-4	—	Error output	Normal	Error
OUT12	TBO.3 5-6	—	Defrost output	Normal	Defrost
OUT13	TBO.4 1-2	—	2-way valve 2a output *2	OFF	ON
OUT14	—	CNP4	Water circulation pump 4 output (DHW)	OFF	ON
OUT15	TBO.3 7-8	—	Comp. ON signal	OFF	ON

Do not connect to the terminals that are indicated as "—" in the "Terminal block" field.

- *1. For 2-zone temperature control.
- *2. For 2-zone valve ON/OFF control.

EHST20C-YM9C, EHST20C-YM9EC, EHST20D-YM9C, EHPT20X-YM9C

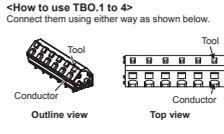
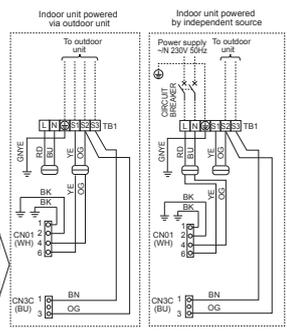
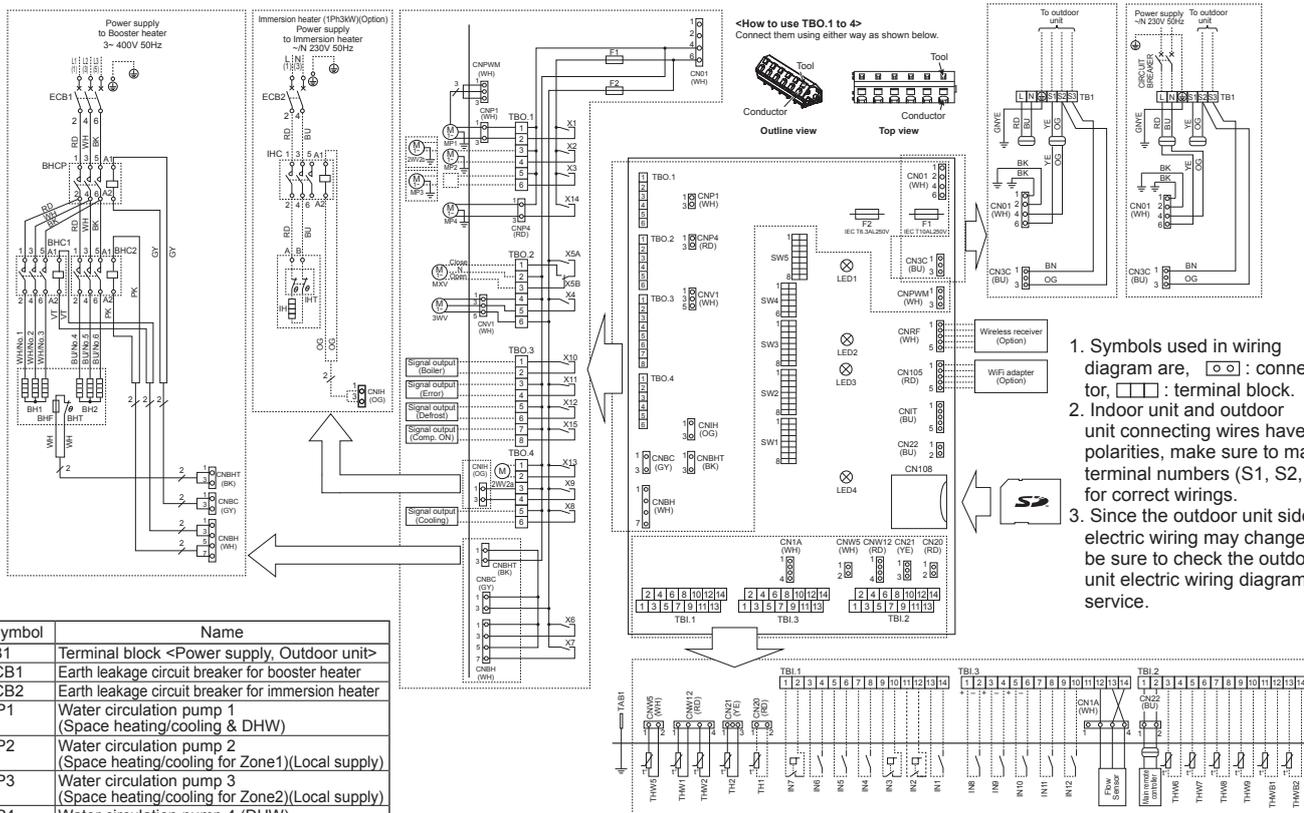

1. Symbols used in wiring diagram are, : connector, : terminal block.
2. Indoor unit and outdoor unit connecting wires have polarities, make sure to match terminal numbers (S1, S2, S3) for correct wiring.
3. Since the outdoor unit side electric wiring may change, be sure to check the outdoor unit electric wiring diagram for service.

Symbol	Name
TB1	Terminal block <Power supply, Outdoor>
ECB1	Earth leakage circuit breaker for booster heater
ECB2	Earth leakage circuit breaker for immersion heater
MP1	Water circulation pump 1 (Space heating/cooling & DHW)
MP2	Water circulation pump 2 (Space heating/cooling for Zone1)(Local supply)
MP3	Water circulation pump 3 (Space heating/cooling for Zone2)(Local supply)
MP4	Water circulation pump 4 (DHW)
3WV	3-way valve
2WV2a	2-way valve (For Zone 1)(Local supply)
2WV2b	2-way valve (For Zone 2)(Local supply)
MXV	Mixing valve (Local supply)
BHT	Thermostat for booster heater
BHF	Thermal fuse for booster heater
BH1	Booster heater 1
BH2	Booster heater 2
BHC1	Contactor for booster heater 1
BHC2	Contactor for booster heater 2
BHCP	Contactor for booster heater protection
IHT	Thermostat (fixed temp.) for immersion heater
IH	Immersion heater
IHC	Contactor for immersion heater
TH1	Thermistor (Room temp.)(Option)
TH2	Thermistor (Ref. liquid temp.)
THW1	Thermistor (Flow water temp.)
THW2	Thermistor (Return water temp.)
THW5	Thermistor (DHW tank water temp.)
THW6	Thermistor (Zone1 flow temp.)(Option)
THW7	Thermistor (Zone1 return temp.)(Option)
THW8	Thermistor (Zone2 flow temp.)(Option)
THW9	Thermistor (Zone2 return temp.)(Option)
THWB1	Thermistor (Boiler flow temp.)(Option)
THWB2	Thermistor (Boiler return temp.)(Option)
IN1	Room thermostat 1 (Local supply)
IN2	Flow switch 1 (Local supply)
IN3	Flow switch 2 (Local supply)
IN4	Demand control (Local supply)
IN5	Outdoor thermostat (Local supply)
IN6	Room thermostat 2 (Local supply)
IN7	Flow switch 3 (Local supply)
IN8	Electric energy meter 1 (Local supply)
IN9	Electric energy meter 2 (Local supply)
IN10	Heat meter (Local supply)
IN11	Smart grid ready input (Local supply)
IN12	Smart grid ready input (Local supply)
IN1A	Flow sensor
FLOW TEMP. CONTROLLER (FTC5)	
TBO.1-4	Terminal block <Outputs>
TBI.1-3	Terminal block <Signal Inputs, Thermistor>
F1	Fuse (IEC T10AL250V)
F2	Fuse (IEC T6.3AL250V)
SW1-5	DIP switch *See 3.1.2 DIP switch functions.
X1-15	Relay
LED1	Power supply (FTC5)
LED2	Power supply (Main remote controller)
LED3	Communication (FTC5-Outdoor unit)
LED4	Reading or writing data to SD card
CNPWM	Pump speed control signal for MP1
CN108	SD card connector

Table 1 Signal Inputs

Name	Terminal block	Connector	Item	OFF (Open)	ON (Short)
IN1	TBI.1 13-14	—	Room thermostat 1 input *1	Refer to SW2-1 in <3.1.2 DIP switch functions>.	
IN2	TBI.1 11-12	—	Flow switch 1 input	Refer to SW2-2 in <3.1.2 DIP switch functions>.	
IN3	TBI.1 9-10	—	Flow switch 2 input (Zone1)	Refer to SW3-2 in <3.1.2 DIP switch functions>.	
IN4	TBI.1 7-8	—	Demand control input	Normal	Heat source OFF/ Boiler operation *3
IN5	TBI.1 5-6	—	Outdoor thermostat input *2	Standard operation	Heater operation/ Boiler operation *3
IN6	TBI.1 3-4	—	Room thermostat 2 input *1	Refer to SW3-1 in <3.1.2 DIP switch functions>.	
IN7	TBI.1 1-2	—	Flow switch 3 input (Zone2)	Refer to SW3-3 in <3.1.2 DIP switch functions>.	
IN8	TBI.3 1-2	—	Electric energy meter 1	Refer to installation manual.	
IN9	TBI.3 3-4	—	Electric energy meter 2		
IN10	TBI.3 5-6	—	Heat meter		
IN11	TBI.3 7-8	—	Smart grid ready input		
IN12	TBI.3 9-10	—	Smart grid ready input		
IN1A	TBI.3 12-14	CN1A	Flow sensor		

- *1. Set the ON/OFF cycle time of the room thermostat for 10 minutes or more; otherwise the compressor may be damaged.
- *2. If using outdoor thermostat for controlling operation of heaters, the lifetime of the heaters and related parts may be reduced.
- *3. To turn on the boiler operation, use the main remote controller to select "Boiler" in "External input setting" screen in the service menu.

Table 2 Outputs

Name	Terminal block	Connector	Item	OFF	ON
OUT1	TBO.1 1-2	CNP1	Water circulation pump 1 output (Space heating/cooling & DHW)	OFF	ON
OUT2	TBO.1 3-4	—	Water circulation pump 2 output (Space heating/cooling for Zone1)	OFF	ON
OUT3	TBO.1 5-6	—	Water circulation pump 3 output (Space heating/cooling for Zone2) *1	OFF	ON
			2-way valve 2b output *2		
OUT4	TBO.2 4-6	CNV1	3-way valve output	Heating	DHW
OUT5	TBO.2 1-2	—	Mixing valve output *1	Stop	Close
OUT6	TBO.2 2-3	—	Mixing valve output *1	Stop	Open
OUT7	—	CNBH 1-3	Booster heater 1 output	OFF	ON
OUT8	—	CNBH 5-7	Booster heater 2 output	OFF	ON
OUT9	TBO.4 5-6	—	Cooling signal output	OFF	ON
OUT10	TBO.4 3-4	CNIH	Immersion heater output	OFF	ON
OUT11	TBO.3 1-2	—	Boiler output	OFF	ON
OUT12	TBO.3 3-4	—	Error output	Normal	Error
OUT13	TBO.3 5-6	—	Defrost output	Normal	Defrost
OUT14	TBO.4 1-2	—	2-way valve 2a output *2	OFF	ON
OUT15	—	CNP4	Water circulation pump 4 output (DHW)	OFF	ON
OUT15	TBO.3 7-8	—	Comp. ON signal	OFF	ON

Do not connect to the terminals that are indicated as "—" in the "Terminal block" field.
 *1. For 2-zone temperature control.
 *2. For 2-zone valve ON/OFF control.

EHST20C-TM9C, EHPT20X-TM9C

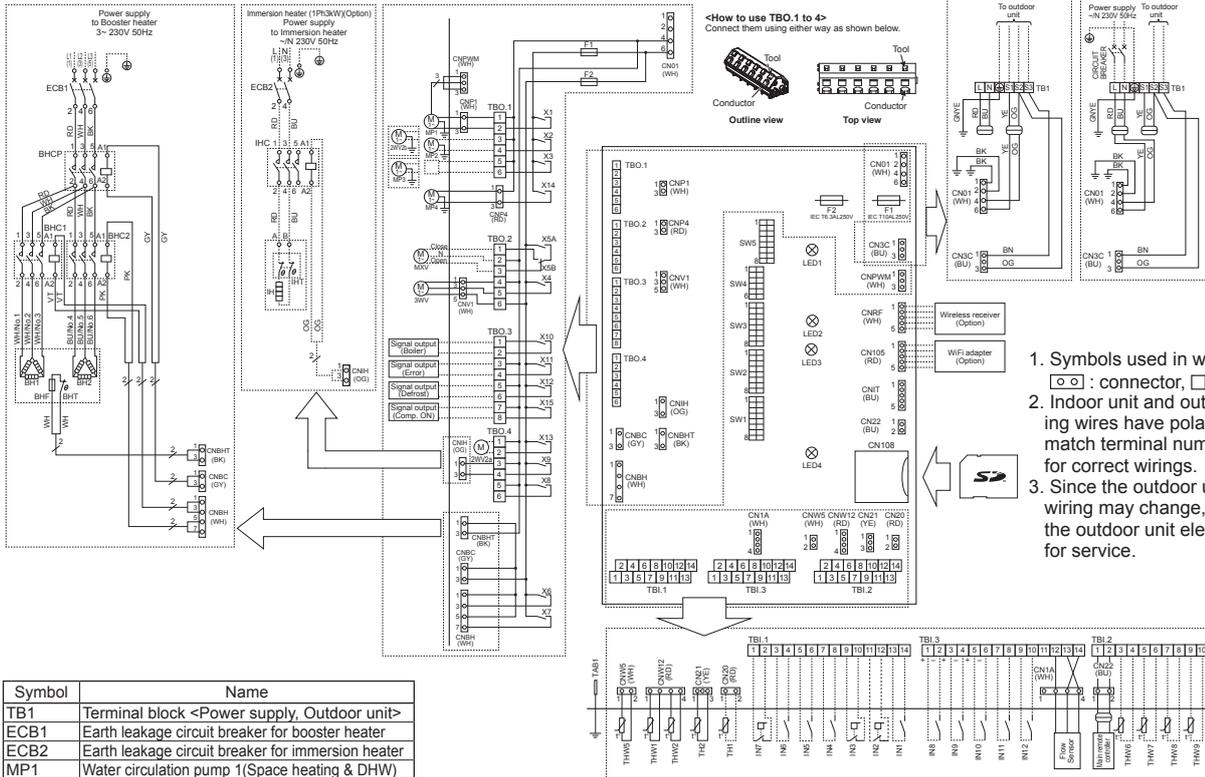

1. Symbols used in wiring diagram are, : connector, : terminal block.
2. Indoor unit and outdoor unit connecting wires have polarities, make sure to match terminal numbers (S1, S2, S3) for correct wirings.
3. Since the outdoor unit side electric wiring may change, be sure to check the outdoor unit electric wiring diagram for service.

Symbol	Name
TB1	Terminal block <Power supply, Outdoor unit>
ECB1	Earth leakage circuit breaker for booster heater
ECB2	Earth leakage circuit breaker for immersion heater
MP1	Water circulation pump 1(Space heating & DHW)
MP2	Water circulation pump 2 (Space heating for Zone1)(Local supply)
MP3	Water circulation pump 3 (Space heating for Zone2)(Local supply)
MP4	Water circulation pump 4 (DHW)
3WV	3-way valve
2WV2a	2-way valve (For Zone 1)(Local supply)
2WV2b	2-way valve (For Zone 2)(Local supply)
MXV	Mixing valve (Local supply)
BHT	Thermostat for booster heater
BHF	Thermal fuse for booster heater
BH1	Booster heater 1
BH2	Booster heater 2
BHC1	Contactor for booster heater 1
BHC2	Contactor for booster heater 2
BHCP	Contactor for booster heater protection
IHT	Thermostat (fixed temp.) for immersion heater
IH	Immersion heater
IHC	Contactor for immersion heater
TH1	Thermistor (Room temp.)(Option)
TH2	Thermistor (Ref. liquid temp.)
THW1	Thermistor (Flow water temp.)
THW2	Thermistor (Return water temp.)
THW5	Thermistor (DHW tank water temp.)
THW6	Thermistor (Zone1 flow temp.)(Option)
THW7	Thermistor (Zone1 return temp.)(Option)
THW8	Thermistor (Zone2 flow temp.)(Option)
THW9	Thermistor (Zone2 return temp.)(Option)
THWB1	Thermistor (Boiler flow temp.)(Option)
THWB2	Thermistor (Boiler return temp.)(Option)
IN1	Room thermostat 1 (Local supply)
IN2	Flow switch 1 (Local supply)
IN3	Flow switch 2 (Local supply)
IN4	Demand control (Local supply)
IN5	Outdoor thermostat (Local supply)
IN6	Room thermostat 2 (Local supply)
IN7	Flow switch 3 (Local supply)
IN8	Electric energy meter 1 (Local supply)
IN9	Electric energy meter 2 (Local supply)
IN10	Heat meter (Local supply)
IN11	Smart grid ready input (Local supply)
IN12	Smart grid ready input (Local supply)
IN1A	Flow sensor
FLOW TEMP. CONTROLLER (FTC5)	
TBO.1-4	Terminal block <Outputs>
TBI.1-3	Terminal block <Signal Inputs, Thermistor>
F1	Fuse (IEC T10AL250V)
F2	Fuse (IEC T6.3AL250V)
SW1-5	DIP switch *See 3.1.2 DIP switch functions.
X1-15	Relay
LED1	Power supply (FTC5)
LED2	Power supply (Main remote controller)
LED3	Communication (FTC5-Outdoor unit)
LED4	Reading or writing data to SD card
CNPWM	Pump speed control signal for MP1
CN108	SD card connector

Table 1 Signal Inputs

Name	Terminal block	Connector	Item	OFF (Open)	ON (Short)
IN1	TBI.1 13-14	—	Room thermostat 1 input *1	Refer to SW2-1 in <3.1.2 DIP switch functions>.	
IN2	TBI.1 11-12	—	Flow switch 1 input	Refer to SW2-2 in <3.1.2 DIP switch functions>.	
IN3	TBI.1 9-10	—	Flow switch 2 input (Zone1)	Refer to SW3-2 in <3.1.2 DIP switch functions>.	
IN4	TBI.1 7-8	—	Demand control input	Normal	Heat source OFF/ Boiler operation *3
IN5	TBI.1 5-6	—	Outdoor thermostat input *2	Standard operation	Heater operation/ Boiler operation *3
IN6	TBI.1 3-4	—	Room thermostat 2 input *1	Refer to SW3-1 in <3.1.2 DIP switch functions>.	
IN7	TBI.1 1-2	—	Flow switch 3 input (Zone2)	Refer to SW3-3 in <3.1.2 DIP switch functions>.	
IN8	TBI.3 1-2	—	Electric energy meter 1		
IN9	TBI.3 3-4	—	Electric energy meter 2		
IN10	TBI.3 5-6	—	Heat meter		
IN11	TBI.3 7-8	—	Smart grid ready input		
IN12	TBI.3 9-10	—	Smart grid ready input		
IN1A	TBI.3 12-14	CN1A	Flow sensor		

- *1. Set the ON/OFF cycle time of the room thermostat for 10 minutes or more; otherwise the compressor may be damaged.
- *2. If using outdoor thermostat for controlling operation of heaters, the lifetime of the heaters and related parts may be reduced.
- *3. To turn on the boiler operation, use the main remote controller to select "Boiler" in "External input setting" screen in the service menu.

Table 2 Outputs

Name	Terminal block	Connector	Item	OFF	ON
OUT1	TBO.1 1-2	CNP1	Water circulation pump 1 output (Space heating & DHW)	OFF	ON
OUT2	TBO.1 3-4	—	Water circulation pump 2 output (Space heating for Zone1)	OFF	ON
OUT3	TBO.1 5-6	—	Water circulation pump 3 output (Space heating for Zone2) *1	OFF	ON
			2-way valve 2b output *2		
OUT4	TBO.2 4-6	CNV1	3-way valve output		
OUT5	TBO.2 1-2	—	Mixing valve output *1	Heating	DHW
				Stop	Close
				Open	
OUT6	—	CNBH 1-3	Booster heater 1 output	OFF	ON
OUT7	—	CNBH 5-7	Booster heater 2 output	OFF	ON
OUT9	TBO.4 3-4	CNIH	Immersion heater output	OFF	ON
OUT10	TBO.3 1-2	—	Boiler output	OFF	ON
OUT11	TBO.3 3-4	—	Error output	Normal	Error
OUT12	TBO.3 5-6	—	Defrost output	Normal	Defrost
OUT13	TBO.4 1-2	—	2-way valve 2a output *2	OFF	ON
OUT14	—	CNP4	Water circulation pump 4 output (DHW)	OFF	ON
OUT15	TBO.3 7-8	—	Comp. ON signal	OFF	ON

Do not connect to the terminals that are indicated as "—" in the "Terminal block" field.

- *1. For 2-zone temperature control.
- *2. For 2-zone valve ON/OFF control.

EHST20C-MEC, EHST20D-MEC, EHST20D-MHC, ERST20C-MEC, ERST20D-MEC

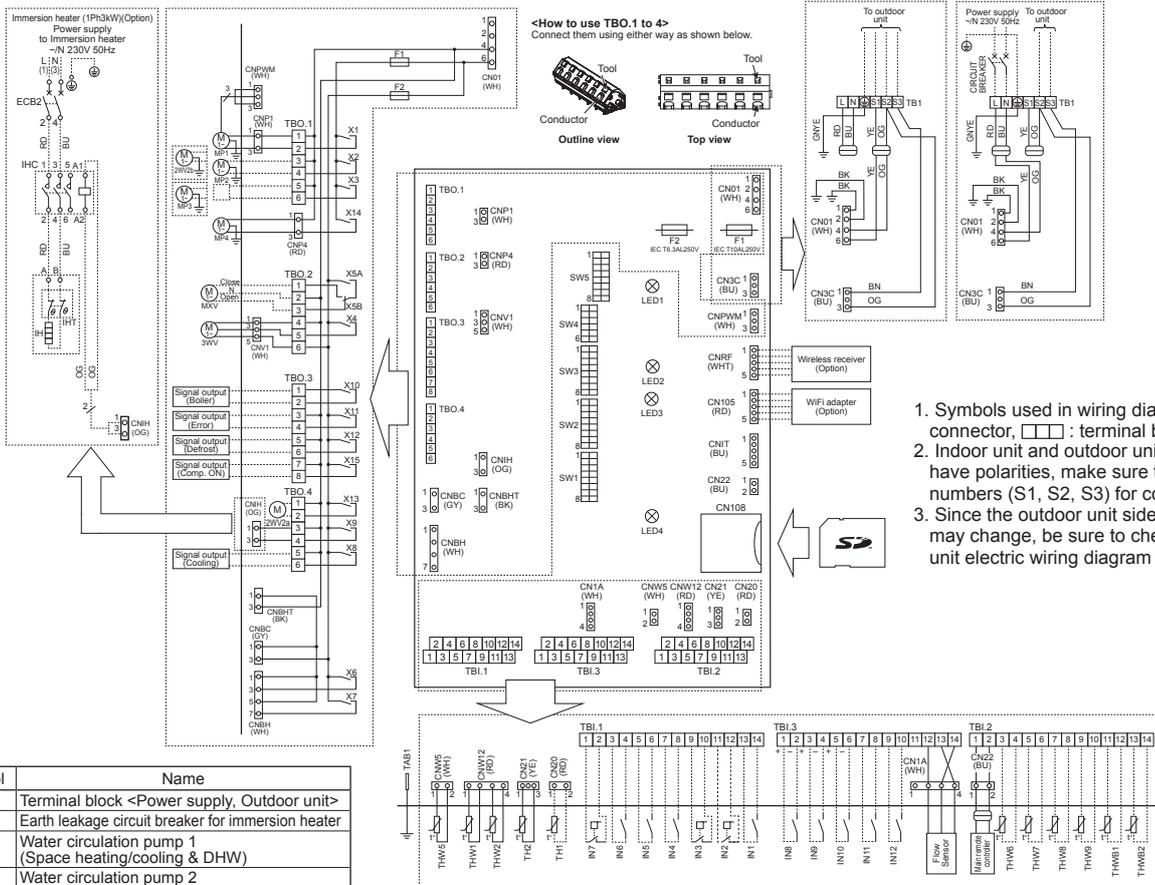

1. Symbols used in wiring diagram are, : connector, : terminal block.
2. Indoor unit and outdoor unit connecting wires have polarities, make sure to match terminal numbers (S1, S2, S3) for correct wirings.
3. Since the outdoor unit side electric wiring may change, be sure to check the outdoor unit electric wiring diagram for service.

Symbol	Name
TB1	Terminal block <Power supply, Outdoor unit>
ECB2	Earth leakage circuit breaker for immersion heater
MP1	Water circulation pump 1 (Space heating/cooling & DHW)
MP2	Water circulation pump 2 (Space heating/cooling for Zone1)(Local supply)
MP3	Water circulation pump 3 (Space heating/cooling for Zone2)(Local supply)
MP4	Water circulation pump 4 (DHW)
3VV	3-way valve
2WV2a	2-way valve (For Zone 1)(Local supply)
2WV2b	2-way valve (For Zone 2)(Local supply)
MXV	Mixing valve (Local supply)
IHT	Thermostat (fixed temp.) for immersion heater
IH	Immersion heater
IHC	Contactor for immersion heater
TH1	Thermistor (Room temp.)(Option)
TH2	Thermistor (Ref. liquid temp.)
THW1	Thermistor (Flow water temp.)
THW2	Thermistor (Return water temp.)
THW5	Thermistor (DHW tank water temp.)
THW6	Thermistor (Zone1 flow temp.)(Option)
THW7	Thermistor (Zone1 return temp.)(Option)
THW8	Thermistor (Zone2 flow temp.)(Option)
THW9	Thermistor (Zone2 return temp.)(Option)
THWB1	Thermistor (Boiler flow temp.)(Option)
THWB2	Thermistor (Boiler return temp.)(Option)
IN1	Room thermostat 1 (Local supply)
IN2	Flow switch 1 (Local supply)
IN3	Flow switch 2 (Local supply)
IN4	Demand control (Local supply)
IN5	Outdoor thermostat (Local supply)
IN6	Room thermostat 2 (Local supply)
IN7	Flow switch 3 (Local supply)
IN8	Electric energy meter 1 (Local supply)
IN9	Electric energy meter 2 (Local supply)
IN10	Heat meter (Local supply)
IN11	Smart grid ready input (Local supply)
IN12	Smart grid ready input (Local supply)
IN1A	Flow sensor
FLOW TEMP. CONTROLLER (FTC5)	
TBO.1-4	Terminal block <Outputs>
TBI.1-3	Terminal block <Signal Inputs, Thermistor>
F1	Fuse (IEC T10AL250V)
F2	Fuse (IEC T6.3AL250V)
SW1-5	DIP switch *See 3.1.2 DIP switch functions.
X1-15	Relay
LED1	Power supply (FTC5)
LED2	Power supply (Main remote controller)
LED3	Communication (FTC5-Outdoor unit)
LED4	Reading or writing data to SD card
CNPWM	Pump speed control signal for MP1
CN108	SD card connector

Table 1 Signal Inputs

Name	Terminal block	Connector	Item	OFF (Open)	ON (Short)
IN1	TBI.1 13-14	—	Room thermostat 1 input *1	Refer to SW2-1 in <3.1.2 DIP switch functions>.	
IN2	TBI.1 11-12	—	Flow switch 1 input	Refer to SW2-2 in <3.1.2 DIP switch functions>.	
IN3	TBI.1 9-10	—	Flow switch 2 input (Zone1)	Refer to SW3-2 in <3.1.2 DIP switch functions>.	
IN4	TBI.1 7-8	—	Demand control input	Normal	Heat source OFF/ Boiler operation *3
IN5	TBI.1 5-6	—	Outdoor thermostat input *2	Standard operation	Heater operation/ Boiler operation *3
IN6	TBI.1 3-4	—	Room thermostat 2 input *1	Refer to SW3-1 in <3.1.2 DIP switch functions>.	
IN7	TBI.1 1-2	—	Flow switch 3 input (Zone2)	Refer to SW3-3 in <3.1.2 DIP switch functions>.	
IN8	TBI.3 1-2	—	Electric energy meter 1	Refer to installation manual.	
IN9	TBI.3 3-4	—	Electric energy meter 2		
IN10	TBI.3 5-6	—	Heat meter		
IN11	TBI.3 7-8	—	Smart grid ready input		
IN12	TBI.3 9-10	—	Smart grid ready input		
IN1A	TBI.3 12-14	CN1A	Flow sensor		

*1. Set the ON/OFF cycle time of the room thermostat for 10 minutes or more; otherwise the compressor may be damaged.

*2. If using outdoor thermostat for controlling operation of heaters, the lifetime of the heaters and related parts may be reduced.

*3. To turn on the boiler operation, use the main remote controller to select "Boiler" in "External input setting" screen in the service menu.

Table 2 Outputs

Name	Terminal block	Connector	Item	OFF	ON
OUT1	TBO.1 1-2	CNP1	Water circulation pump 1 output (Space heating/cooling & DHW)	OFF	ON
OUT2	TBO.1 3-4	—	Water circulation pump 2 output (Space heating/cooling for Zone1)	OFF	ON
OUT3	TBO.1 5-6	—	Water circulation pump 3 output (Space heating/cooling for Zone2) *1	OFF	ON
OUT4	TBO.2 4-6	CNV1	3-way valve 2b output *2	Heating	DHW
OUT5	TBO.2 1-2	—	Mixing valve output *1	Stop	Close
OUT6	TBO.2 2-3	—	Mixing valve output *1	Open	Open
OUT7	—	CNH3 1-3	Booster heater 1 output	OFF	ON
OUT8	—	CNH3 5-7	Booster heater 2 output	OFF	ON
OUT9	TBO.4 5-6	—	Cooling signal output	OFF	ON
OUT10	TBO.4 3-4	CNIH	Immersion heater output	OFF	ON
OUT11	TBO.3 1-2	—	Boiler output	OFF	ON
OUT12	TBO.3 3-4	—	Error output	Normal	Error
OUT13	TBO.3 5-6	—	Defrost output	Normal	Defrost
OUT14	TBO.4 1-2	—	2-way valve 2a output *2	OFF	ON
OUT15	—	CNP4	Water circulation pump 4 output (DHW)	OFF	ON
OUT16	TBO.3 7-8	—	Comp. ON signal	OFF	ON

Do not connect to the terminals that are indicated as "—" in the "Terminal block" field.

*1. For 2-zone temperature control.

*2. For 2-zone valve ON/OFF control.

EHPT20X-MHCW, EHST20C-MHCW, EHST20D-MHCW

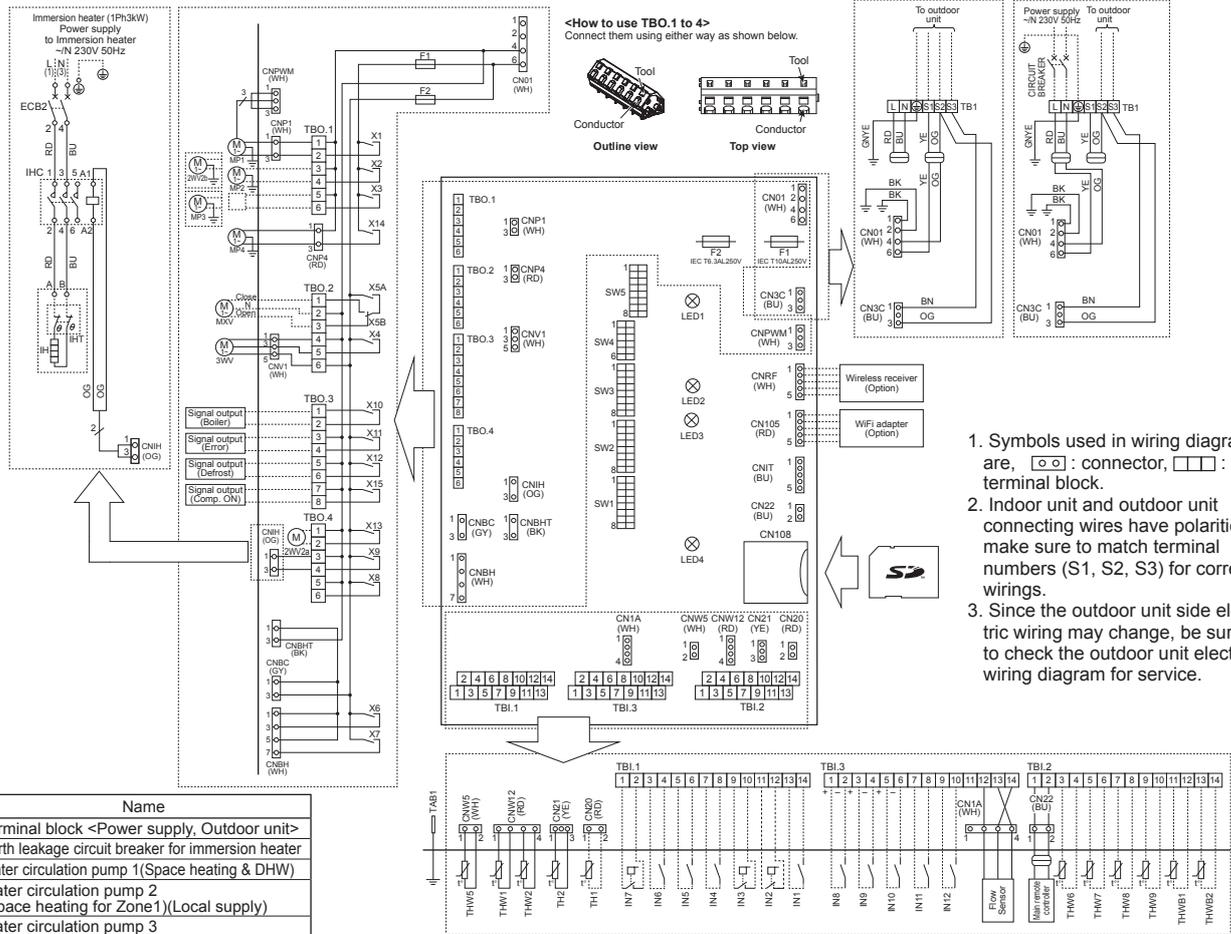

<How to use TBO.1 to 4>
Connect them using either way as shown below.

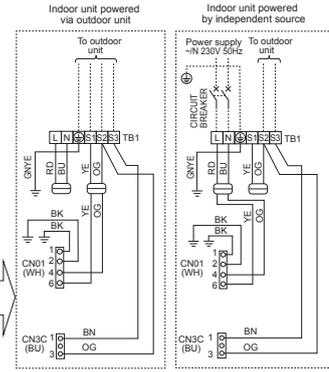

1. Symbols used in wiring diagram are, : terminal block.
2. Indoor unit and outdoor unit connecting wires have polarities, make sure to match terminal numbers (S1, S2, S3) for correct wirings.
3. Since the outdoor unit side electric wiring may change, be sure to check the outdoor unit electric wiring diagram for service.

Symbol	Name
TB1	Terminal block <Power supply, Outdoor unit>
ECB2	Earth leakage circuit breaker for immersion heater
MP1	Water circulation pump 1(Space heating & DHW)
MP2	Water circulation pump 2 (Space heating for Zone1)(Local supply)
MP3	Water circulation pump 3 (Space heating for Zone2)(Local supply)
MP4	Water circulation pump 4 (DHW)
3WV	3-way valve
2WV2a	2-way valve (For Zone 1)(Local supply)
2WV2b	2-way valve (For Zone 2)(Local supply)
MXV	Mixing valve (Local supply)
IHT	Thermostat (fixed temp.) for immersion heater
IH	Immersion heater
IHC	Contactor for immersion heater
TH1	Thermistor (Room temp.)(Option)
TH2	Thermistor (Ref. liquid temp.)
THW1	Thermistor (Flow water temp.)
THW2	Thermistor (Return water temp.)
THW5	Thermistor (DHW tank water temp.)
THW6	Thermistor (Zone1 flow temp.)(Option)
THW7	Thermistor (Zone1 return temp.)(Option)
THW8	Thermistor (Zone2 flow temp.)(Option)
THW9	Thermistor (Zone2 return temp.)(Option)
THWB1	Thermistor (Boiler flow temp.)(Option)
THWB2	Thermistor (Boiler return temp.)(Option)
IN1	Room thermostat 1 (Local supply)
IN2	Flow switch 1 (Local supply)
IN3	Flow switch 2 (Local supply)
IN4	Demand control (Local supply)
IN5	Outdoor thermostat (Local supply)
IN6	Room thermostat 2 (Local supply)
IN7	Flow switch 3 (Local supply)
IN8	Electric energy meter 1 (Local supply)
IN9	Electric energy meter 2 (Local supply)
IN10	Heat meter (Local supply)
IN11	Smart grid ready input (Local supply)
IN12	Smart grid ready input (Local supply)
IN1A	Flow sensor
FLOW TEMP. CONTROLLER (FTC5)	
TBO.1-4	Terminal block <Outputs>
TBI.1-3	Terminal block <Signal Inputs, Thermistor>
F1	Fuse (IEC T10AL250V)
F2	Fuse (IEC T6.3AL250V)
SW1-5	DIP switch *See 3.1.2 DIP switch functions.
X1-15	Relay
LED1	Power supply (FTC5)
LED2	Power supply (Main remote controller)
LED3	Communication (FTC5-Outdoor unit)
LED4	Reading or writing data to SD card
CNPWM	Pump speed control signal for MP1
CN108	SD card connector

Table 1 Signal Inputs

Name	Terminal block	Connector	Item	OFF (Open)	ON (Short)
IN1	TBI.1 13-14	—	Room thermostat 1 input *1	Refer to SW2-1 in <3.1.2 DIP switch functions>.	
IN2	TBI.1 11-12	—	Flow switch 1 input	Refer to SW2-2 in <3.1.2 DIP switch functions>.	
IN3	TBI.1 9-10	—	Flow switch 2 input (Zone1)	Refer to SW3-2 in <3.1.2 DIP switch functions>.	
IN4	TBI.1 7-8	—	Demand control input	Normal Heat source OFF/ Boiler operation *3	
IN5	TBI.1 5-6	—	Outdoor thermostat input *2	Standard operation Heater operation/ Boiler operation *3	
IN6	TBI.1 3-4	—	Room thermostat 2 input *1	Refer to SW3-1 in <3.1.2 DIP switch functions>.	
IN7	TBI.1 1-2	—	Flow switch 3 input (Zone2)	Refer to SW3-3 in <3.1.2 DIP switch functions>.	
IN8	TBI.3 1-2	—	Electric energy meter 1	Refer to installation manual.	
IN9	TBI.3 3-4	—	Electric energy meter 2		
IN10	TBI.3 5-6	—	Heat meter		
IN11	TBI.3 7-8	—	Smart grid ready input		
IN12	TBI.3 9-10	—	Smart grid ready input		
IN1A	TBI.3 12-14	CN1A	Flow sensor		

- *1. Set the ON/OFF cycle time of the room thermostat for 10 minutes or more; otherwise the compressor may be damaged.
- *2. If using outdoor thermostat for controlling operation of heaters, the lifetime of the heaters and related parts may be reduced.
- *3. To turn on the boiler operation, use the main remote controller to select "Boiler" in "External input setting" screen in the service menu.

Table 2 Outputs

Name	Terminal block	Connector	Item	OFF	ON
OUT1	TBO.1 1-2	CNP1	Water circulation pump 1 output (Space heating & DHW)	OFF	ON
OUT2	TBO.1 3-4	—	Water circulation pump 2 output (Space heating for Zone1)	OFF	ON
OUT3	TBO.1 5-6	—	Water circulation pump 3 output (Space heating for Zone2) *1	OFF	ON
			2-way valve 2b output *2		
OUT4	TBO.2 4-6	CNV1	3-way valve output	Heating	DHW
OUT5	TBO.2 1-2	—	Mixing valve output *1	Stop	Close
	TBO.2 2-3	—			Open
OUT6	—	CNBH 1-3	Booster heater 1 output	OFF	ON
OUT7	—	CNBH 5-7	Booster heater 2 output	OFF	ON
OUT9	TBO.4 3-4	CNIH	Immersion heater output	OFF	ON
OUT10	TBO.3 1-2	—	Boiler output	OFF	ON
OUT11	TBO.3 3-4	—	Error output	Normal	Error
OUT12	TBO.3 5-6	—	Defrost output	Normal	Defrost
OUT13	TBO.4 1-2	—	2-way valve 2a output *2	OFF	ON
OUT14	—	CNP4	Water circulation pump 4 output (DHW)	OFF	ON
OUT15	TBO.3 7-8	—	Comp. ON signal	OFF	ON

Do not connect to the terminals that are indicated as "—" in the "Terminal block" field.

- *1. For 2-zone temperature control.
- *2. For 2-zone valve ON/OFF control.

3.1.2 Dip switch functions (Cylinder unit)

Located on the FTC printed circuit board are 4 sets of small white switches known as Dip switches. The Dip switch number is printed on the circuit board next to the relevant switches. The word ON is printed on the circuit board and on the Dip switch block itself. To move the switch you will need to use a pin or the corner of a thin metal ruler or similar.

Dip switch settings are listed below in the table below. Only an authorised installer can change DIP switch setting under one's own responsibility according to the installation condition. Make sure to turn off both indoor unit and outdoor unit power supplies before changing the switch settings.

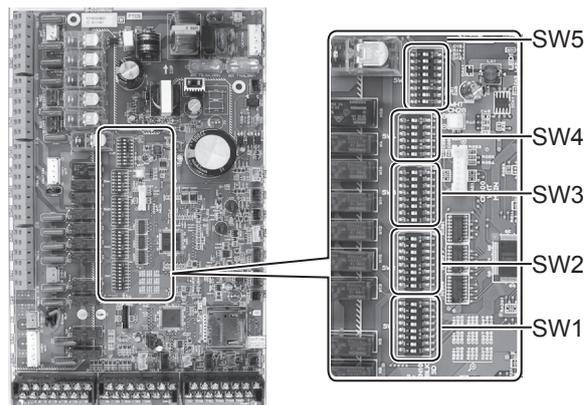

<Figure 3.1.1>

DIP switch	Function	OFF	ON	Default settings: Indoor unit model			
SW1	SW1-1	Boiler	WITHOUT Boiler	WITH Boiler	OFF		
	SW1-2	Heat pump maximum outlet water temperature	55°C	60°C	ON *1		
	SW1-3	DHW tank	WITHOUT DHW tank	WITH DHW tank	ON		
	SW1-4	Immersion heater	WITHOUT Immersion heater	WITH Immersion heater	OFF: E**T20*-°C ON : EH*T20*-°HC*		
	SW1-5	Booster heater	WITHOUT Booster heater	WITH Booster heater	OFF: E**T20*-M°C* ON : E**T20*-°M 2/6/9°C		
	SW1-6	Booster heater function	For heating only	For heating and DHW	OFF: E**T20*-M°C* ON : E**T20*-°M 2/6/9°C		
	SW1-7	Outdoor unit type	Split type	Packaged type	OFF: E*ST20*-M**C* ON : EHPT20X*-M**C*		
	SW1-8	Wireless remote controller	WITHOUT Wireless remote controller	WITH Wireless remote controller	OFF		
SW2	SW2-1	Room thermostat1 input (IN1) logic change	Zone1 operation stop at thermostat short	Zone1 operation stop at thermostat open	OFF		
	SW2-2	Flow switch1 input (IN2) logic change	Failure detection at short	Failure detection at open	OFF		
	SW2-3	Booster heater capacity restriction	Inactive	Active	OFF: Except EH*T20*-VM2°C ON : EH*T20*-VM2°C		
	SW2-4	Cooling mode function	Inactive	Active	OFF: EH*T20*-M**C* ON : ERST20*-M**C		
	SW2-5	Automatic switch to backup heat source operation (When outdoor unit stops by error)	Inactive	Active *2	OFF		
	SW2-6	Mixing tank	WITHOUT Mixing tank	WITH Mixing tank	OFF		
	SW2-7	2-zone temperature control	Inactive	Active *6	OFF		
	SW2-8	Flow sensor	WITHOUT Flow sensor	WITH Flow sensor	ON		
SW3	SW3-1	Room thermostat 2 input (IN6) logic change	Zone2 operation stop at thermostat short	Zone2 operation stop at thermostat open	OFF		
	SW3-2	Flow switch 2 input (IN3) logic change	Failure detection at short	Failure detection at open	OFF		
	SW3-3	Flow switch 3 input (IN7) logic change	Failure detection at short	Failure detection at open	OFF		
	SW3-4	Electric energy meter	WITHOUT Electric energy meter	WITH Electric energy meter	OFF		
	SW3-5	Heating mode function *3	Inactive	Active	ON		
	SW3-6	2-zone valve ON/OFF control	Inactive	Active	OFF		
	SW3-7	Heat exchanger for DHW	Coil in tank	External plate HEX	ON		
	SW3-8	Heat meter	WITHOUT Heat meter	WITH Heat meter	OFF		
SW4	SW4-1	—	—	—	OFF		
	SW4-2	—	—	—	OFF		
	SW4-3	—	—	—	OFF		
	SW4-4	Indoor unit only operation (during installation work) *4	Inactive	Active	OFF		
	SW4-5	Emergency mode (Heater only operation)	Normal	Emergency mode (Heater only operation)	OFF *5		
	SW4-6	Emergency mode (Boiler operation)	Normal	Emergency mode (Boiler operation)	OFF *5		
SW5	SW5-1	—	—	—	OFF		
	SW5-2	Advanced auto adaptation *7	Inactive	Active	OFF: Other than R1/R2 models ON: R1/R2 models		
	SW5-3	Capacity code					
	SW5-4		SW5-3	SW5-4	SW5-5	SW5-6	SW5-7
	SW5-5	E*ST20C*-M°C*	ON	ON	ON	ON	OFF
	SW5-6	E*ST20D*-M°C*	ON	OFF	OFF	ON	OFF
	SW5-7	EHPT20X*-M°C*	OFF	OFF	OFF	OFF	OFF
	SW5-8	—	—	—	—	—	OFF

<Table 3.1.1>

Notes: *1. When the cylinder unit is connected with a PUMY-P/SUHZ-SW outdoor unit of which maximum outlet water temperature is 55°C, DIP SW1-2 must be changed to OFF.
 *2. External output (OUT11) will be available. For safety reasons, this function is not available for certain errors. (In that case, system operation must be stopped and only the water circulation pump keeps running.)
 *3. This switch functions only when the cylinder unit is connected with a PUHZ-FRP outdoor unit. When another type of outdoor unit is connected, the heating mode function is active regardless of the fact that this switch is ON or OFF.
 *4. Space heating and DHW can be operated only in indoor unit, like an electric boiler. (Refer to "5.5 Indoor unit only operation" in Installation Manual.)
 *5. If emergency mode is no longer required, return the switch to OFF position.
 *6. Active only when SW3-6 is set to OFF.
 *7. SW5-2, "Advanced auto adaptation" is available only for R1 and R2 models.

Automatic switch to backup heat source operation

Back-up heat source operation (*1) will automatically run when the outdoor unit stops abnormally. To enable the function, switch Dip SW 2-5 to ON. During the back-up operation, an error code(s) and the contact number will be displayed alternately. External output (OUT11) will be available. To clear the fault(s), reset the power breakers on the indoor and outdoor units.

<Applicable error codes (*2)>

E6 to E9, ED, P6, P8, U1 to U8, UD, UE, UF, UL, UP

(*1) Prolonged running of the back-up operation may affect the life of the heat source.

(*2) For safety reasons, this function is not available for certain faults. (System operation must be stopped and only pump keeps running.)

3.1.3 Connecting inputs/outputs (Cylinder unit)

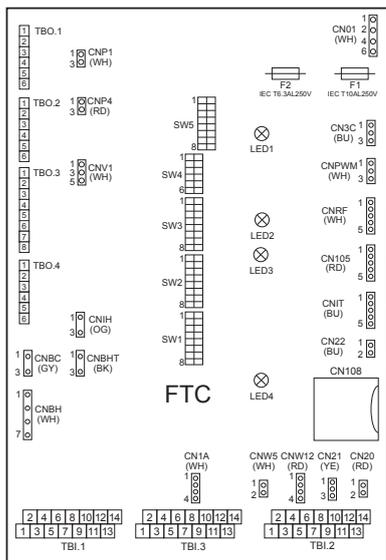

When the wires are wired to adjacent terminals use ring terminals and insulate the wires.

<Figure 3.1.2>

Signal inputs

Name	Terminal block	Connector	Item	OFF (Open)	ON (Short)
IN1	TBI.1 13-14	—	Room thermostat 1 input *1	Refer to SW2-1 in <5.1 DIP Switch Functions>.	
IN2	TBI.1 11-12	—	Flow switch 1 input	Refer to SW2-2 in <5.1 DIP Switch Functions>.	
IN3	TBI.1 9-10	—	Flow switch 2 input (Zone1)	Refer to SW3-2 in <5.1 DIP Switch Functions>.	
IN4	TBI.1 7-8	—	Demand control input	Normal	Heat source OFF/ Boiler operation *3
IN5	TBI.1 5-6	—	Outdoor thermostat input *2	Standard operation	Heater operation/ Boiler operation *3
IN6	TBI.1 3-4	—	Room thermostat 2 input *1	Refer to SW3-1 in <5.1 DIP Switch Functions>.	
IN7	TBI.1 1-2	—	Flow switch 3 input (Zone2)	Refer to SW3-3 in <5.1 DIP Switch Functions>.	
IN8	TBI.3 1-2	—	Electric energy meter 1	*4	
IN9	TBI.3 3-4	—	Electric energy meter 2		
IN10	TBI.3 5-6	—	Heat meter	*5	
IN11	TBI.3 7-8	—	Smart grid ready input		
IN12	TBI.3 9-10	—	Smart grid ready input		
IN1A	TBI.3 12-14	CN1A	Flow sensor	—	—

*1. Set the ON/OFF cycle time of the room thermostat for 10 minutes or more; otherwise the compressor may be damaged.

*2. If using outdoor thermostat for controlling operation of heaters, the lifetime of the heaters and related parts may be reduced.

*3. To turn on the boiler operation, use the main remote controller to select "Boiler" in "External input setting" screen in the service menu.

*4. Connectable electric energy meter and heat meter

- Pulse type: Voltage free contact for 12VDC detection by FTC (TBI.3 1, 3 and 5 pins have a positive voltage.)
- Pulse duration: Minimum ON time: 40ms, Minimum OFF time: 100ms
- Possible unit of pulse: 0.1 pulse/kWh, 1 pulse/kWh, 10 pulse/kWh, 100 pulse/kWh, 1000 pulse/kWh

Those values can be set by the main remote controller. (Refer to the menu tree in "6. System Set Up".)

*5. As for the SG ready, refer to "5.6 Smart grid ready" in Installation Manual.

Wiring specification and local supply parts

Item	Name	Model and specifications
Signal input function	Signal input wire	Use sheathed vinyl coated cord or cable. Max. 30 m Wire type: CV, CVS or equivalent Wire size: Stranded wire 0.13 mm ² to 1.25 mm ² Solid wire: ø0.4 mm to ø1.2 mm
	Switch	Non-voltage "a" contact signals Remote switch: minimum applicable load 12V DC, 1mA

Thermistor inputs

Name	Terminal block	Connector	Item	Optional part model
TH1	—	CN20	Thermistor (Room temp.) (Option)	PAC-SE41TS-E
TH2	—	CN21	Thermistor (Ref. liquid temp.)	—
THW1	—	CNW12 1-2	Thermistor (Flow water temp.)	—
THW2	—	CNW12 3-4	Thermistor (Return water temp.)	—
THW5	—	CNW5	Thermistor (DHW tank water temp.)	—
THW6	TBI.2 3-4	—	Thermistor (Zone1 flow water temp.) (Option) *1	PAC-TH011-E
THW7	TBI.2 5-6	—	Thermistor (Zone1 return water temp.) (Option) *1	
THW8	TBI.2 7-8	—	Thermistor (Zone2 flow water temp.) (Option) *1	PAC-TH011-E
THW9	TBI.2 9-10	—	Thermistor (Zone2 return water temp.) (Option) *1	
THWB1	TBI.2 11-12	—	Thermistor (Boiler flow water temp.) (Option) *1	PAC-TH011HT-E
THWB2	TBI.2 13-14	—	Thermistor (Boiler return water temp.) (Option) *1	

Ensure to wire thermistor wirings away from the power line and/or OUT1 to 15 wirings.

*1. The maximum length of the thermistor wiring is 30 m. When the wires are wired to adjacent terminals, use ring terminals and insulate the wires.

The length of the optional thermistors are 5 m. If you need to splice and extend the wirings, following points must be carried out.

- 1) Connect the wirings by soldering.
- 2) Insulate each connecting point against dust and water.

Outputs

Name	Terminal block	Connector	Item	OFF	ON	Signal/Max. current	Max. total current
OUT1	TBO.1 1-2	CNP1	Water circulation pump 1 output (Space heating/cooling & DHW)	OFF	ON	230V AC 1.0A Max.	4.0A (a)
OUT2	TBO.1 3-4	—	Water circulation pump 2 output (Space heating/cooling for Zone1)	OFF	ON	230V AC 1.0A Max.	
OUT3	TBO.1 5-6	—	Water circulation pump 3 output (Space heating/cooling for Zone2) *1 2-way valve 2b output *2	OFF	ON	230V AC 1.0A Max.	
OUT14	—	CNP4	Water circulation pump 4 output (DHW)	OFF	ON	230V AC 1.0A Max.	3.0A (b)
OUT4	TBO.2 4-6	CNV1	3-way valve output	Heating	DHW	230V AC 0.1A Max.	
OUT5	TBO.2 1-2 TBO.2 2-3	—	Mixing valve output *1	Stop	Close Open	230V AC 0.1A Max.	
OUT6	—	CNBH 1-3	Booster heater 1 output	OFF	ON	230V AC 0.5A Max. (Relay)	
OUT7	—	CNBH 5-7	Booster heater 2 output	OFF	ON	230V AC 0.5A Max. (Relay)	
OUT8	TBO.4 5-6	—	Cooling signal output	OFF	ON	230V AC 0.5A Max.	
OUT9	TBO.4 3-4	CNIH	Immersion heater output	OFF	ON	230V AC 0.5A Max. (Relay)	
OUT11	TBO.3 3-4	—	Error output	Normal	Error	230V AC 0.5A Max.	
OUT12	TBO.3 5-6	—	Defrost output	Normal	Defrost	230V AC 0.5A Max.	
OUT13	TBO.4 1-2	—	2-way valve 2a output *2	OFF	ON	230V AC 0.1A Max.	
OUT15	TBO.3 7-8	—	Comp ON signal	OFF	ON	230V AC 0.5A Max.	
OUT10	TBO.3 1-2	—	Boiler output	OFF	ON	non-voltage contact ·220-240V AC (30V DC) 0.5A or less ·10mA 5V DC or more	—

Do not connect to the terminals that are indicated as “—” in the “Terminal block” field.

*1 For 2-zone temperature control.

*2 For 2-zone valve ON/OFF control.

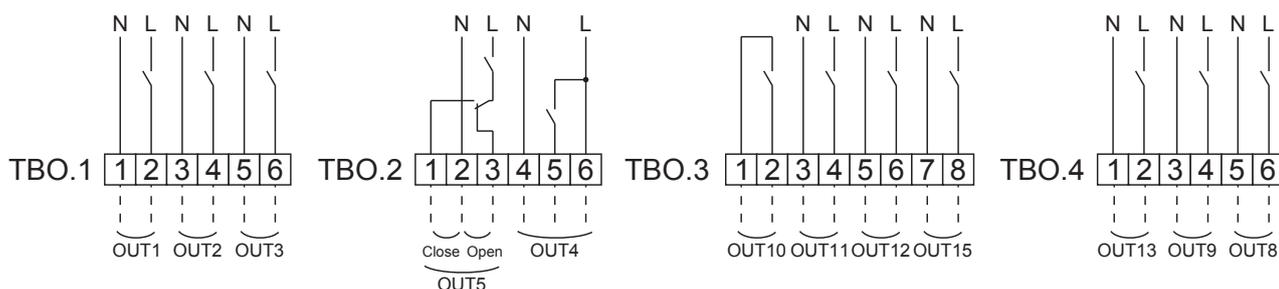

Wiring specification and local supply parts

Item	Name	Model and specifications
External output function	Outputs wire	Use sheathed vinyl coated cord or cable. Max. 30 m Wire type: CV, CVS or equivalent Wire size: Stranded wire 0.25 mm ² to 1.5 mm ² Solid wire: ø0.57 mm to ø1.2 mm

How to use TBO.1 to 4

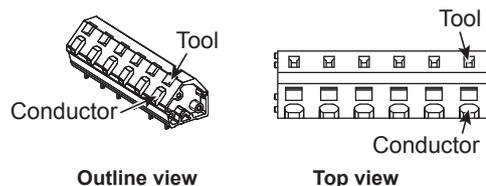

Connect them using either way as shown above.

Note:

1. When the cylinder unit is powered via outdoor unit, the maximum grand total current of (a)+(b) is 3.0 A.
2. Do not connect multiple water circulation pumps directly to each output (OUT1, OUT2, and OUT3). In such a case, connect them via (a) relay(s).
3. Do not connect water circulation pumps to both TBO.1 1-2 and CNP1 at the same time.
4. Connect an appropriate surge absorber to OUT10 (TBO.3 1-2) depending on the load at site.
5. Stranded wire should be processed with insulation-covered bar terminal (DIN46228-4 standard compatible type).

3.1.4 Electrical Connection (Cylinder unit)

All electrical work should be carried out by a suitably qualified technician. Failure to comply with this could lead to electrocution, fire, and death. It will also invalidate product warranty. All wiring should be according to national wiring regulations.

Breaker abbreviation	Meaning
ECB1	Earth leakage circuit breaker for booster heater
ECB2	Earth leakage circuit breaker for immersion heater
TB1	Terminal block 1

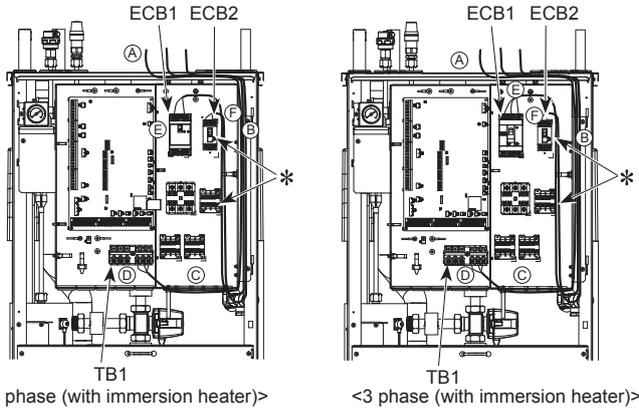

The cylinder unit can be powered in two ways.

1. Power cable is run from the outdoor unit to the cylinder unit.
2. Cylinder unit has independent power source

Connections should be made to the terminals indicated in the figures to the left below depending on the phase.

Booster heater and immersion heater should be connected independently from one another to dedicated power supplies.

- Ⓐ Locally supplied wiring should be inserted through the inlets situated on the top of the cylinder unit. (Refer to <Table 2.1.1>.)
- Ⓑ Wiring should be fed down the right hand side of the control and electrical box and clamped in place using clips provided.
- Ⓒ The wires should be inserted individually through the cable inlets as below.
 - ③ Outputs wire
 - ④ Signal input wire
 - ⑤ Wireless receiver (option) wire (PAR-WR51R-E)
 - ⑦⑨ and ⑩ Power line and indoor-outdoor wire
- Ⓓ Connect the outdoor unit – cylinder unit connecting cable to TB1.
- Ⓔ Connect the power cable for the booster heater to ECB1.
- Ⓕ If immersion heater is present, connect the power cable to ECB2.

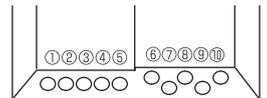

- Avoid contact between wiring and parts (*).
- Make sure that ECB1 and ECB2 are ON.
- On completion of wiring ensure main remote controller cable is connected to the relay connector.

Option 1: Cylinder unit powered via outdoor unit

<1 phase>

Affix label A that is included with the manuals near each wiring diagram for cylinder unit and outdoor units.

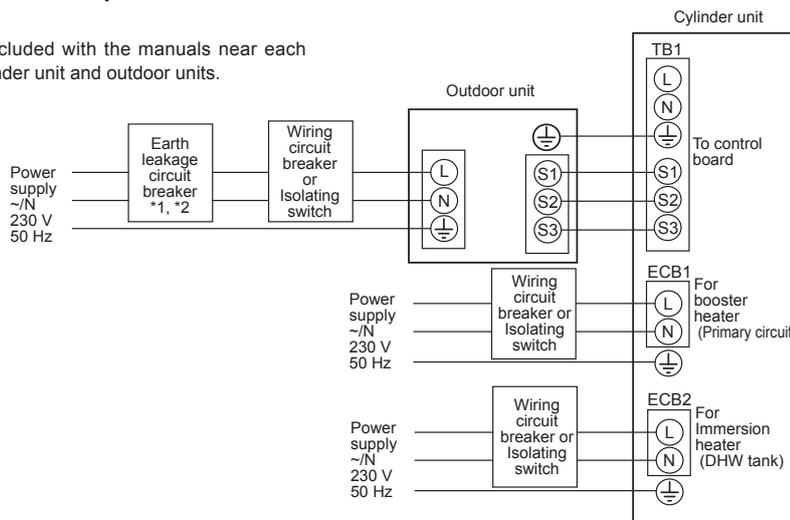

<Figure 3.1.3>

Electrical connections 1 phase

Description	Power supply	Capacity	Breaker	Wiring
Booster heater (Primary circuit)	~N 230 V 50 Hz	2 kW	16 A *2	2.5 mm ²
		6 kW	32 A *2	6.0 mm ²
Immersion heater (DHW tank)	~N 230 V 50 Hz	3 kW	16 A *2	2.5 mm ²

Wiring No. x size (mm ²)	Description	Quantity	Capacity
Cylinder unit - Outdoor unit	Cylinder unit - Outdoor unit	*3	3 × 1.5 (polar)
	Cylinder unit - Outdoor unit earth	*3	1 × Min. 1.5
Circuit rating	Cylinder unit - Outdoor unit S1 - S2	*4	230 V AC
	Cylinder unit - Outdoor unit S2 - S3	*4	24 V DC

- *2. A breaker with at least 3.0 mm contact separation in each pole shall be provided. Use earth leakage breaker (NV). The breaker shall be provided to ensure disconnection of all active phase conductors of the supply.
- *3. Max. 45 m
If 2.5 mm² used, Max. 50 m
If 2.5 mm² used and S3 separated, Max. 80 m
- *4. The values given in the table above are not always measured against the ground value.

- Note:**
1. Wiring size must comply with the applicable local and national codes.
 2. Indoor unit/outdoor unit connecting cords shall not be lighter than polychloroprene sheathed flexible cord. (Design 60245 IEC 57)
Indoor unit power supply cords shall not be lighter than polychloroprene sheathed flexible cord. (Design 60227 IEC 53)
 3. Install an earth longer than other cables.
 4. Please keep enough output capacity of power supply for each heater. Insufficient power supply capacity might cause chattering.

<3 phase>

Affix label A that is included with the manuals near each wiring diagram for cylinder unit and outdoor units.

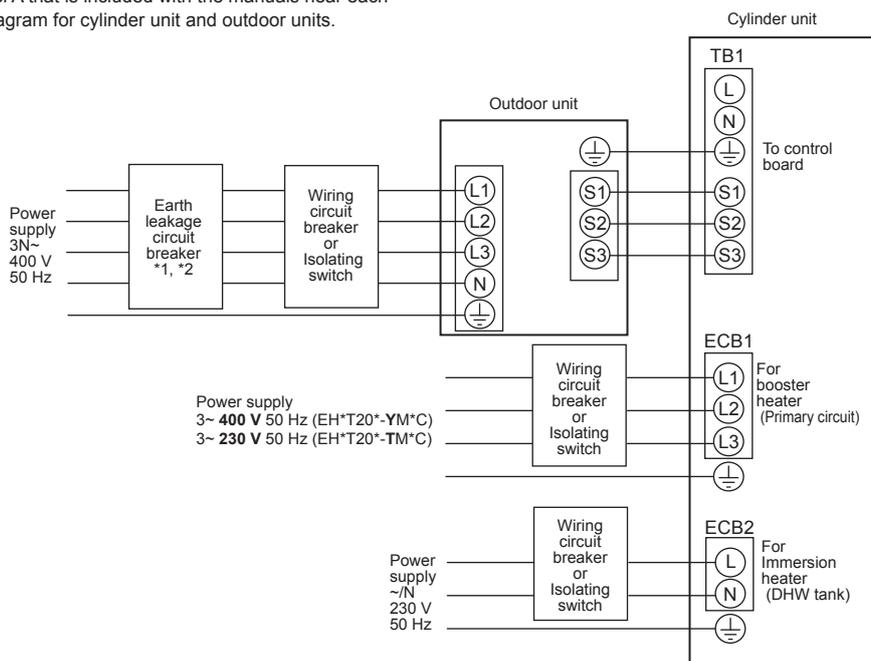

*1 If the installed earth leakage circuit breaker does not have an over-current protection function, install a breaker with that function along the same power line.

<Figure 3.1.4>
Electrical connections 3 phase

Description	Power supply	Capacity (Indoor unit Ref.)	Breaker	Wiring
Booster heater (Primary circuit)	3~ 400 V 50 Hz	9 kW	16 A *2	2.5 mm ²
	3~ 230 V 50 Hz	9 kW	32 A *2	6.0 mm ²
Immersion heater (DHW tank)	~/N 230 V 50 Hz	3 kW	16 A *2	2.5 mm ²

Wiring No. x size (mm ²)	Cylinder unit - Outdoor unit	*3	3 x 1.5 (polar)
	Cylinder unit - Outdoor unit earth	*3	1 x Min. 1.5
Circuit rating	Cylinder unit - Outdoor unit S1 - S2	*4	230 V AC
	Cylinder unit - Outdoor unit S2 - S3	*4	24 V DC

*2. A breaker with at least 3.0 mm contact separation in each pole shall be provided. Use earth leakage breaker (NV). The breaker shall be provided to ensure disconnection of all active phase conductors of the supply.

*3. Max. 45 m

If 2.5 mm² used, Max. 50 m

If 2.5 mm² used and S3 separated, Max. 80 m

*4. The values given in the table above are not always measured against the ground value.

- Note:**
1. Wiring size must comply with the applicable local and national codes.
 2. Indoor unit/outdoor unit connecting cords shall not be lighter than polychloroprene sheathed flexible cord. (Design 60245 IEC 57)
Indoor unit power supply cords shall not be lighter than polychloroprene sheathed flexible cord. (Design 60227 IEC 53)
 3. Install an earth longer than other cables.
 4. Please keep enough output capacity of power supply for each heater. Insufficient power supply capacity might cause chattering.

Option 2: Cylinder unit powered by independent source.

If the cylinder unit and outdoor unit have separate power supplies, the following requirements MUST be carried out:

- Change the interconnected wiring in the control and electrical box of the cylinder unit (see Figure 3.1.5)
- Turn the outdoor unit DIP switch SW8-3 to ON
- Turn on the outdoor unit BEFORE the cylinder unit.
- Power by independent source is not available for particular models of outdoor unit model. For more detail, refer to the connecting outdoor unit Installation Manual.

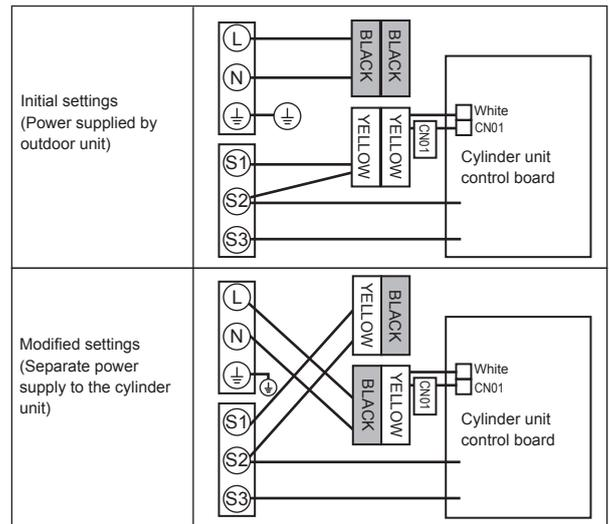

<Figure 3.1.5>

<1 phase>

Affix label B that is included with the manuals near each wiring diagram for cylinder unit and outdoor units.

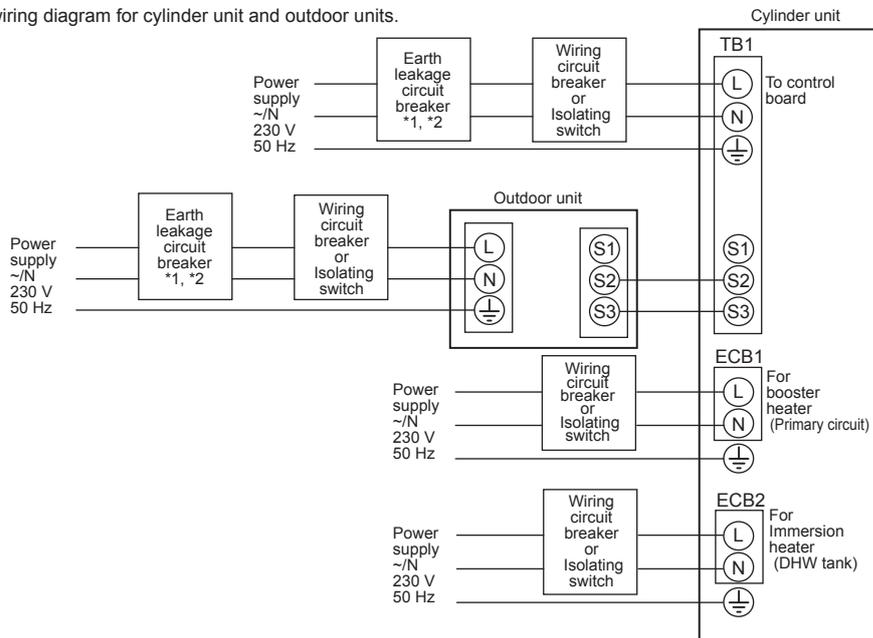

*1 If the installed earth leakage circuit breaker does not have an over-current protection function, install a breaker with that function along the same power line.

<Figure 3.1.6>
Electrical connections 1 phase

Description	Power supply	Capacity	Breaker	Wiring
Booster heater (Primary circuit)	~/N 230 V 50 Hz	2 kW	16 A *2	2.5 mm ²
		6 kW	32 A *2	6.0 mm ²
Immersion heater (DHW tank)	~/N 230 V 50 Hz	3 kW	16 A *2	2.5 mm ²

Cylinder unit power supply		~/N 230 V 50 Hz
Cylinder unit input capacity		*2 16 A
Main switch (Breaker)		
Wiring No. x size (mm ²)	Cylinder unit power supply	2 x Min. 1.5
	Cylinder unit power supply earth	1 x Min. 1.5
	Cylinder unit - Outdoor unit	*3 2 x Min. 0.3
	Cylinder unit - Outdoor unit earth	—
Circuit rating	Cylinder unit L - N	*4 230 V AC
	Cylinder unit - Outdoor unit S1 - S2	*4 —
	Cylinder unit - Outdoor unit S2 - S3	*4 24 V DC

*2. A breaker with at least 3.0 mm contact separation in each pole shall be provided. Use earth leakage breaker (NV). The breaker shall be provided to ensure disconnection of all active phase conductors of the supply.

*3. Max. 120 m

*4. The values given in the table above are not always measured against the ground value.

- Note:**
1. Wiring size must comply with the applicable local and national codes.
 2. Indoor unit/outdoor unit connecting cords shall not be lighter than polychloroprene sheathed flexible cord. (Design 60245 IEC 57)
Indoor unit power supply cords shall not be lighter than polychloroprene sheathed flexible cord. (Design 60227 IEC 53)
 3. Install an earth longer than other cables.
 4. Please keep enough output capacity of power supply for each heater. Insufficient power supply capacity might cause chattering.

<3 phase>

Affix label B that is included with the manuals near each wiring diagram for cylinder unit and outdoor units.

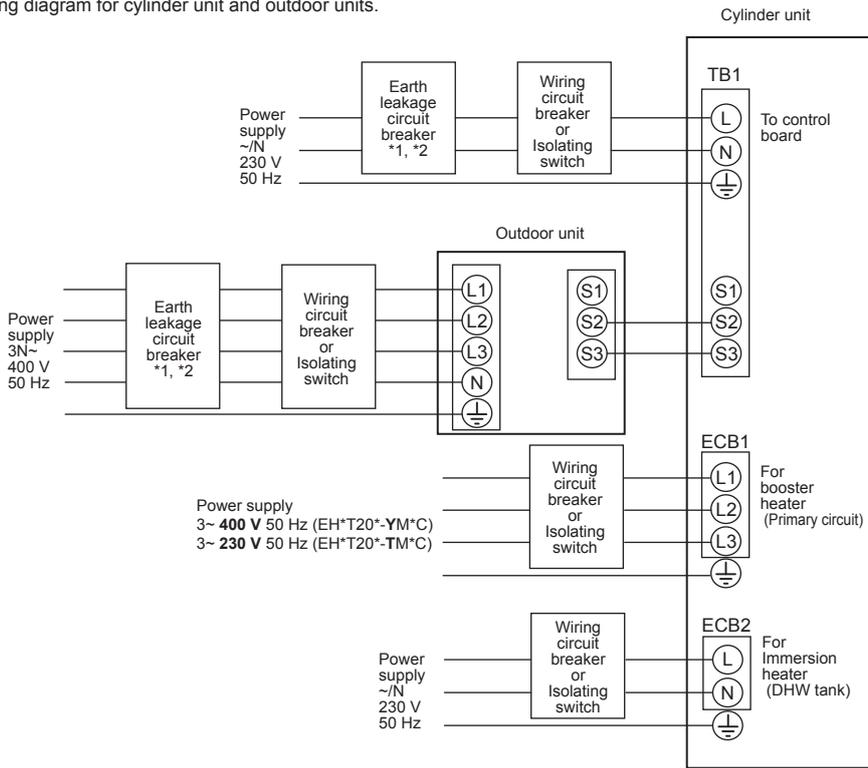

*1 If the installed earth leakage circuit breaker does not have an over-current protection function, install a breaker with that function along the same power line.

<Figure 3.1.7>
Electrical connections 3 phase

Description	Power supply	Capacity (Indoor unit Ref.)	Breaker	Wiring
Booster heater (Primary circuit)	3~ 400 V 50 Hz	9 kW	16 A *2	2.5 mm ²
	3~ 230 V 50 Hz	9 kW	32 A *2	6.0 mm ²
Immersion heater (DHW tank)	~N 230 V 50 Hz	3 kW	16 A *2	2.5 mm ²

Cylinder unit power supply		~N 230 V 50 Hz
Cylinder unit input capacity	*2	16 A
Main switch (Breaker)		
Wiring No. x size (mm ²)	Cylinder unit power supply	2 x Min. 1.5
	Cylinder unit power supply earth	1 x Min. 1.5
	Cylinder unit - Outdoor unit	*3 2 x Min. 0.3
	Cylinder unit - Outdoor unit earth	—
Circuit rating	Cylinder unit L - N	*4 230 V AC
	Cylinder unit - Outdoor unit S1 - S2	*4 —
	Cylinder unit - Outdoor unit S2 - S3	*4 24 V DC

*2. A breaker with at least 3.0 mm contact separation in each pole shall be provided. Use earth leakage breaker (NV).

The breaker shall be provided to ensure disconnection of all active phase conductors of the supply.

*3. Max. 120 m

*4. The values given in the table above are not always measured against the ground value.

- Note:**
1. Wiring size must comply with the applicable local and national codes.
 2. Indoor unit/outdoor unit connecting cords shall not be lighter than polychloroprene sheathed flexible cord. (Design 60245 IEC 57)
Indoor unit power supply cords shall not be lighter than polychloroprene sheathed flexible cord. (Design 60227 IEC 53)
 3. Install an earth longer than other cables.
 4. Please keep enough output capacity of power supply for each heater. Insufficient power supply capacity might cause chattering.

<Before system set up>

1. At factory setting, the main remote controller cable (Fig. 3.1.8) on the main unit is not connected to the connector (Fig. 3.1.9) on the front panel. After completing installation and wiring in the field, connect the main remote controller cable to the connector, then turn on the power.
2. Insert the included SD memory card into the FTC control board.
(Refer to section 3.3.)

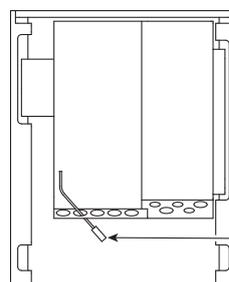

<Figure 3.1.8>

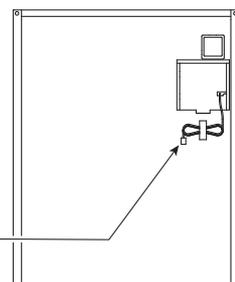

<Figure 3.1.9>

3.2 Hydrobox

3.2.1 Wiring diagrams

EHSC-MEC, EHSD-MEC, EHSD-MC, ERSC-MEC

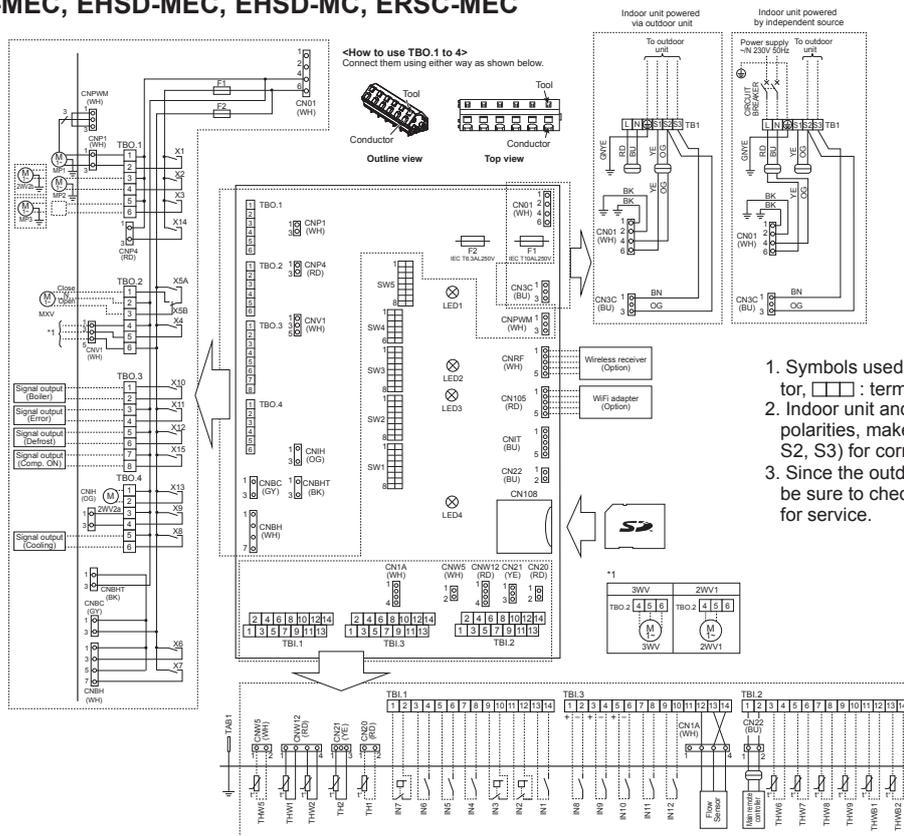

1. Symbols used in wiring diagram are, : connector, : terminal block.
2. Indoor unit and outdoor unit connecting wires have polarities, make sure to match terminal numbers (S1, S2, S3) for correct wirings.
3. Since the outdoor unit side electric wiring may change, be sure to check the outdoor unit electric wiring diagram for service.

Table 1 Signal Inputs

Name	Terminal block	Connector	Item	OFF (Open)	ON (Short)
IN1	TBI.1 13-14	—	Room thermostat 1 input *1	Refer to SW2-1 in <3.2.2 DIP switch functions>.	
IN2	TBI.1 11-12	—	Flow switch 1 input	Refer to SW2-2 in <3.2.2 DIP switch functions>.	
IN3	TBI.1 9-10	—	Flow switch 2 input (Zone1)	Refer to SW3-2 in <3.2.2 DIP switch functions>.	
IN4	TBI.1 7-8	—	Demand control input	Normal	Heater source OFF/ Boiler operation *3
IN5	TBI.1 5-6	—	Outdoor thermostat input *2	Standard operation Heater operation/ Boiler operation *3	
IN6	TBI.1 3-4	—	Room thermostat 2 input *1	Refer to SW3-1 in <3.2.2 DIP switch functions>.	
IN7	TBI.1 1-2	—	Flow switch 3 input (Zone2)	Refer to SW3-3 in <3.2.2 DIP switch functions>.	
IN8	TBI.3 1-2	—	Electric energy meter 1	Refer to installation manual.	
IN9	TBI.3 3-4	—	Electric energy meter 2		
IN10	TBI.3 5-6	—	Heat meter		
IN11	TBI.3 7-8	—	Smart grid ready input		
IN12	TBI.3 9-10	—	Smart grid ready input		
IN1A	TBI.3 12-14	CN1A	Flow sensor		

- *1. Set the ON/OFF cycle time of the room thermostat for 10 minutes or more; otherwise the compressor may be damaged.
- *2. If using outdoor thermostat for controlling operation of heaters, the lifetime of the heaters and related parts may be reduced.
- *3. To turn on the boiler operation, use the main remote controller to select "Boiler" in "External input setting" screen in the service menu.

Table 2 Outputs

Name	Terminal block	Connector	Item	OFF	ON
OUT1	TBO.1 1-2	CNP1	Water circulation pump 1 output (Space heating/cooling & DHW)	OFF	ON
OUT2	TBO.1 3-4	—	Water circulation pump 2 output (Space heating/cooling for Zone1)	OFF	ON
OUT3	TBO.1 5-6	—	Water circulation pump 3 output (Space heating/cooling for Zone2) *1	OFF	ON
			2-way valve 2b output *2		
OUT4	TBO.2 4-6	CNV1	3-way valve (2-way valve) output	Heating	DHW
OUT5	TBO.2 1-2	—	Mixing valve output *1	Stop	Close
				Open	
OUT6	—	CNBH 1-3	Booster heater 1 output	OFF	ON
OUT7	—	CNBH 5-7	Booster heater 2 output	OFF	ON
OUT8	TBO.4 5-6	—	Cooling signal output	OFF	ON
OUT9	TBO.4 3-4	CNIH	Immersion heater output	OFF	ON
OUT10	TBO.3 1-2	—	Boiler output	OFF	ON
OUT11	TBO.3 3-4	—	Error output	Normal	Error
OUT12	TBO.3 5-6	—	Defrost output	Normal	Defrost
OUT13	TBO.4 1-2	—	2-way valve 2a output *2	OFF	ON
OUT14	—	CNP4	Water circulation pump 4 output (DHW)	OFF	ON
OUT15	TBO.3 7-8	—	Comp. ON signal	OFF	ON

Do not connect to the terminals that are indicated as "—" in the "Terminal block" field.

- *1. For 2-zone temperature control.
- *2. For 2-zone valve ON/OFF control.

Symbol	Name
TB1	Terminal block <Power supply, Outdoor unit>
MP1	Water circulation pump 1 (Space heating/cooling & DHW)
MP2	Water circulation pump 2 (Space heating/cooling for Zone1)(Local supply)
MP3	Water circulation pump 3 (Space heating/cooling for Zone2)(Local supply)
MP4	Water circulation pump 4 (DHW)(Local supply)
3WV(2WV1)	3-way valve (2-way valve 1)(Local supply)
2WV2a	2-way valve (For Zone 1)(Local supply)
2WV2b	2-way valve (For Zone 2)(Local supply)
MXV	Mixing valve (Local supply)
TH1	Thermistor (Room temp.)(Option)
TH2	Thermistor (Ref. liquid temp.)
THW1	Thermistor (Flow water temp.)
THW2	Thermistor (Return water temp.)
THW5	Thermistor (DHW tank water temp.)(Option)
THW6	Thermistor (Zone1 flow temp.)(Option)
THW7	Thermistor (Zone1 return temp.)(Option)
THW8	Thermistor (Zone2 flow temp.)(Option)
THW9	Thermistor (Zone2 return temp.)(Option)
THWB1	Thermistor (Boiler flow temp.)(Option)
THWB2	Thermistor (Boiler return temp.)(Option)
IN1	Room thermostat 1 (Local supply)
IN2	Flow switch 1 (Local supply)
IN3	Flow switch 2 (Local supply)
IN4	Demand control (Local supply)
IN5	Outdoor thermostat (Local supply)
IN6	Room thermostat 2 (Local supply)
IN7	Flow switch 3 (Local supply)
IN8	Electric energy meter 1 (Local supply)
IN9	Electric energy meter 2 (Local supply)
IN10	Heat meter (Local supply)
IN11	Smart grid ready input (Local supply)
IN12	Smart grid ready input (Local supply)
IN1A	Flow sensor
FLOW TEMP. CONTROLLER (FTC5)	
TBO.1-4	Terminal block <Outputs>
TBI.1-3	Terminal block <Signal Inputs, Thermistor>
F1	Fuse (IEC T10AL250V)
F2	Fuse (IEC T6.3AL250V)
SW1-5	DIP switch *See <3.2.2 DIP switch functions>.
X1-15	Relay
LED1	Power supply (FTC5)
LED2	Power supply (Main remote controller)
LED3	Communication (FTC5-Outdoor unit)
LED4	Reading or writing data to SD card
CNPWM	Pump speed control signal for MP1
CN108	SD card connector

EHSC-VM2C, EHSC-VM2EC, EHSD-VM2C, ERSC-VM2C, ERSD-VM2C, EHPX-VM2C

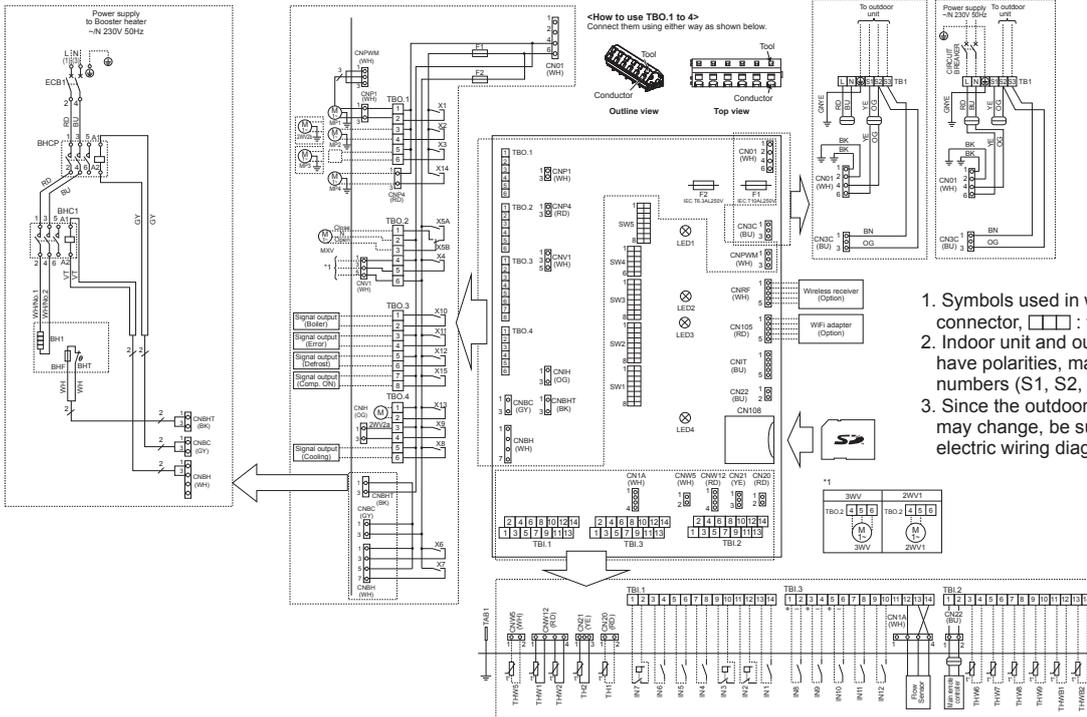

1. Symbols used in wiring diagram are, : connector, : terminal block.
2. Indoor unit and outdoor unit connecting wires have polarities, make sure to match terminal numbers (S1, S2, S3) for correct wirings.
3. Since the outdoor unit side electric wiring may change, be sure to check the outdoor unit electric wiring diagram for service.

Table 1 Signal Inputs

Name	Terminal block	Connector	Item	OFF (Open)	ON (Short)
IN1	TBI.1 13-14	—	Room thermostat 1 input *1	Refer to SW2-1 in <3.2.2 DIP switch functions>.	
IN2	TBI.1 11-12	—	Flow switch 1 input	Refer to SW2-2 in <3.2.2 DIP switch functions>.	
IN3	TBI.1 9-10	—	Flow switch 2 input (Zone1)	Refer to SW3-2 in <3.2.2 DIP switch functions>.	
IN4	TBI.1 7-8	—	Demand control input	Normal	Heat source OFF/Boiler operation *3
IN5	TBI.1 5-6	—	Outdoor thermostat input *2	Standard operation	Heater operation/Boiler operation *3
IN6	TBI.1 3-4	—	Room thermostat 2 input *1	Refer to SW3-1 in <3.2.2 DIP switch functions>.	
IN7	TBI.1 1-2	—	Flow switch 3 input (Zone2)	Refer to SW3-3 in <3.2.2 DIP switch functions>.	
IN8	TBI.3 1-2	—	Electric energy meter 1	Refer to installation manual.	
IN9	TBI.3 3-4	—	Electric energy meter 2		
IN10	TBI.3 5-6	—	Heat meter		
IN11	TBI.3 7-8	—	Smart grid ready input		
IN12	TBI.3 9-10	—	Smart grid ready input		
IN1A	TBI.3 12-14	CN1A	Flow sensor		

- *1. Set the ON/OFF cycle time of the room thermostat for 10 minutes or more; otherwise the compressor may be damaged.
- *2. If using outdoor thermostat for controlling operation of heaters, the lifetime of the heaters and related parts may be reduced.
- *3. To turn on the boiler operation, use the main remote controller to select "Boiler" in "External input setting" screen in the service menu.

Table 2 Outputs

Name	Terminal block	Connector	Item	OFF	ON
OUT1	TBO.1 1-2	CNP1	Water circulation pump 1 output (Space heating/cooling & DHW)	OFF	ON
OUT2	TBO.1 3-4	—	Water circulation pump 2 output (Space heating/cooling for Zone1)	OFF	ON
OUT3	TBO.1 5-6	—	Water circulation pump 3 output (Space heating/cooling for Zone2) *1	OFF	ON
OUT4	TBO.2 4-6	CNV1	3-way valve (2-way valve) output	Heating	DHW
OUT5	TBO.2 1-2	—	Mixing valve output *1	Stop	Close
OUT5	TBO.2 2-3	—		Open	
OUT6	—	CNBH 1-3	Booster heater 1 output	OFF	ON
OUT7	—	CNBH 5-7	Booster heater 2 output	OFF	ON
OUT8	TBO.4 5-6	—	Cooling signal output	OFF	ON
OUT9	TBO.4 3-4	CNIH	Immersion heater output	OFF	ON
OUT10	TBO.3 1-2	—	Boiler output	OFF	ON
OUT11	TBO.3 3-4	—	Error output	Normal	Error
OUT12	TBO.3 5-6	—	Defrost output	Normal	Defrost
OUT13	TBO.4 1-2	—	2-way valve 2a output *2	OFF	ON
OUT14	—	CNP4	Water circulation pump 4 output (DHW)	OFF	ON
OUT15	TBO.3 7-8	—	Comp. ON signal	OFF	ON

Do not connect to the terminals that are indicated as "—" in the "Terminal block" field.

- *1. For 2-zone temperature control.
- *2. For 2-zone valve ON/OFF control.

Symbol	Name
TB1	Terminal block <Power supply, Outdoor unit>
ECB1	Earth leakage circuit breaker for booster heater
MP1	Water circulation pump 1(Space heating & DHW)
MP2	Water circulation pump 2 (Space heating for Zone1)(Local supply)
MP3	Water circulation pump 3 (Space heating for Zone2)(Local supply)
MP4	Water circulation pump 4 (DHW)(Local supply)
3W(2WV1)	3-way valve (2-way valve 1)(Local supply)
2WV2a	2-way valve (For Zone 1)(Local supply)
2WV2b	2-way valve (For Zone 2)(Local supply)
MXV	Mixing valve (Local supply)
BHT	Thermostat for booster heater
BHF	Thermal fuse for booster heater
BH1	Booster heater 1
BHC1	Contact for booster heater 1
BHCP	Contact for booster heater protection
TH1	Thermistor (Room temp.)(Option)
TH2	Thermistor (Ref. liquid temp.)
THW1	Thermistor (Flow water temp.)
THW2	Thermistor (Return water temp.)
THW5	Thermistor (DHW tank water temp.)(Option)
THW6	Thermistor (Zone1 flow temp.)(Option)
THW7	Thermistor (Zone1 return temp.)(Option)
THW8	Thermistor (Zone2 flow temp.)(Option)
THW9	Thermistor (Zone2 return temp.)(Option)
THWB1	Thermistor (Boiler flow temp.)(Option)
THWB2	Thermistor (Boiler return temp.)(Option)
IN1	Room thermostat 1 (Local supply)
IN2	Flow switch 1 (Local supply)
IN3	Flow switch 2 (Local supply)
IN4	Demand control (Local supply)
IN5	Outdoor thermostat (Local supply)
IN6	Room thermostat 2 (Local supply)
IN7	Flow switch 3 (Local supply)
IN8	Electric energy meter 1 (Local supply)
IN9	Electric energy meter 2 (Local supply)
IN10	Heat meter (Local supply)
IN11	Smart grid ready input (Local supply)
IN12	Smart grid ready input (Local supply)
IN1A	Flow sensor
FLOW TEMP. CONTROLLER (FTC5)	
TBO.1-4	Terminal block <Outputs>
TBI.1-3	Terminal block <Signal Inputs, Thermistor>
F1	Fuse (IEC T10AL250V)
F2	Fuse (IEC T6.3AL250V)
SW1-5	DIP switch *See <3.2.2 DIP switch functions>.
X1-15	Relay
LED1	Power supply (FTC5)
LED2	Power supply (Main remote controller)
LED3	Communication (FTC5-Outdoor unit)
LED4	Reading or writing data to SD card
CNPWM	Pump speed control signal for MP1
CN108	SD card connector

EHSC-VM6C, EHSC-VM6EC, EHPX-VM6C

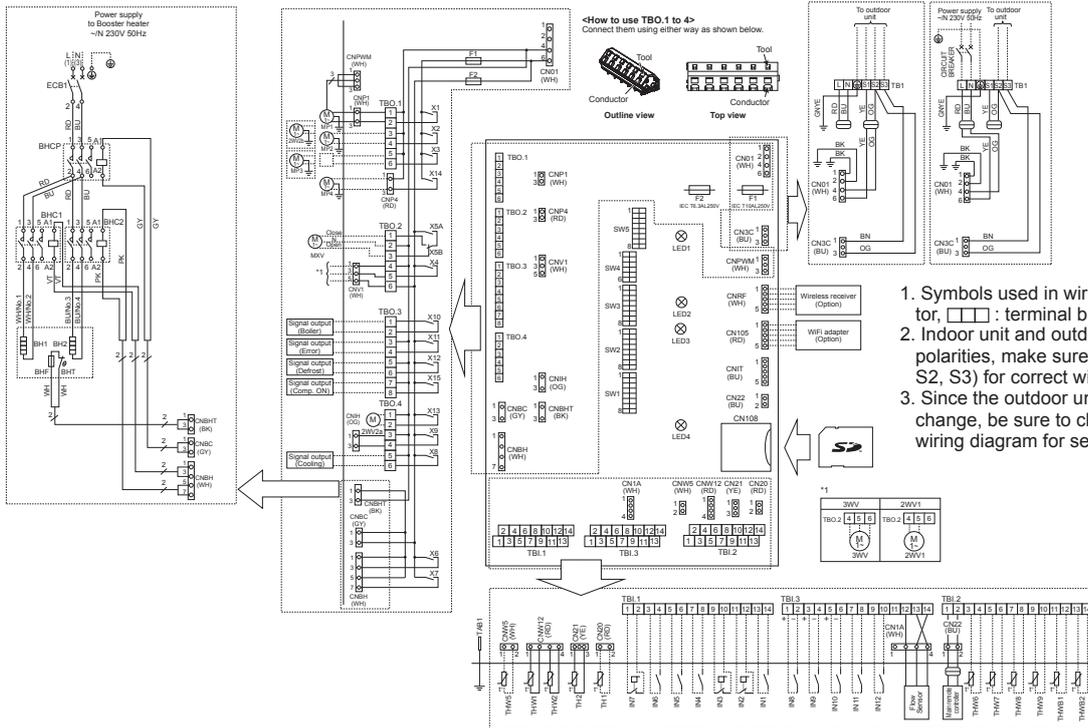

1. Symbols used in wiring diagram are, : connector, : terminal block.
2. Indoor unit and outdoor unit connecting wires have polarities, make sure to match terminal numbers (S1, S2, S3) for correct wirings.
3. Since the outdoor unit side electric wiring may change, be sure to check the outdoor unit electric wiring diagram for service.

Table 1 Signal Inputs

Name	Terminal block	Connector	Item	OFF (Open)	ON (Short)
IN1	TBI.1 13-14	—	Room thermostat 1 input *1	Refer to SW2-1 in <3.2.2 DIP switch functions>.	
IN2	TBI.1 11-12	—	Flow switch 1 input	Refer to SW2-2 in <3.2.2 DIP switch functions>.	
IN3	TBI.1 9-10	—	Flow switch 2 input (Zone1)	Refer to SW3-2 in <3.2.2 DIP switch functions>.	
IN4	TBI.1 7-8	—	Demand control input	Normal	Heat source OFF / Boiler operation *3
IN5	TBI.1 5-6	—	Outdoor thermostat input *2	Standard operation Heater operation/ Boiler operation *3	
IN6	TBI.1 3-4	—	Room thermostat 2 input *1	Refer to SW3-1 in <3.2.2 DIP switch functions>.	
IN7	TBI.1 1-2	—	Flow switch 3 input (Zone2)	Refer to SW3-3 in <3.2.2 DIP switch functions>.	
IN8	TBI.3 1-2	—	Electric energy meter 1	Refer to installation manual.	
IN9	TBI.3 3-4	—	Electric energy meter 2		
IN10	TBI.3 5-6	—	Heat meter		
IN11	TBI.3 7-8	—	Smart grid ready input		
IN12	TBI.3 9-10	—	Flow sensor		
IN1A	TBI.3 12-14	CN1A	Flow sensor		

- *1. Set the ON/OFF cycle time of the room thermostat for 10 minutes or more; otherwise the compressor may be damaged.
- *2. If using outdoor thermostat for controlling operation of heaters, the lifetime of the heaters and related parts may be reduced.
- *3. To turn on the boiler operation, use the main remote controller to select "Boiler" in "External input setting" screen in the service menu.

Table 2 Outputs

Name	Terminal block	Connector	Item	OFF	ON
OUT1	TBO.1 1-2	CNP1	Water circulation pump 1 output (Space heating/cooling & DHW)	OFF	ON
OUT2	TBO.1 3-4	—	Water circulation pump 2 output (Space heating/cooling for Zone1)	OFF	ON
OUT3	TBO.1 5-6	—	Water circulation pump 3 output (Space heating/cooling for Zone2) *1	OFF	ON
OUT4	TBO.2 4-6	CNV1	3-way valve (2-way valve) output	Heating	DHW
OUT5	TBO.2 1-2	—	Mixing valve output *1	Stop	Close
OUT6	—	CNBH1-3	Booster heater 1 output	OFF	ON
OUT7	—	CNBH5-7	Booster heater 2 output	OFF	ON
OUT8	TBO.4 5-6	—	Cooling signal output	OFF	ON
OUT9	TBO.4 3-4	CNIH	Immersion heater output	OFF	ON
OUT10	TBO.3 1-2	—	Boiler output	OFF	ON
OUT11	TBO.3 3-4	—	Error output	Normal	Error
OUT12	TBO.3 5-6	—	Defrost output	Normal	Defrost
OUT13	TBO.4 1-2	—	2-way valve 2a output *2	OFF	ON
OUT14	—	CNP4	Water circulation pump 4 output (DHW)	OFF	ON
OUT15	TBO.3 7-8	—	Comp. ON signal	OFF	ON

Do not connect to the terminals that are indicated as "—" in the "Terminal block" field.

- *1. For 2-zone temperature control.
*2. For 2-zone valve ON/OFF control.

Symbol	Name
TB1	Terminal block <Power supply, Outdoor unit>
ECB1	Earth leakage circuit breaker for booster heater
MP1	Water circulation pump 1 (Space heating & DHW)
MP2	Water circulation pump 2 (Space heating for Zone1)(Local supply)
MP3	Water circulation pump 3 (Space heating for Zone2)(Local supply)
MP4	Water circulation pump 4 (DHW)(Local supply)
3WV(2WV1)	3-way valve (2-way valve 1)(Local supply)
2WV2a	2-way valve (For Zone 1)(Local supply)
2WV2b	2-way valve (For Zone 2)(Local supply)
MXV	Mixing valve (Local supply)
BHT	Thermostat for booster heater
BHF	Thermal fuse for booster heater
BH1	Booster heater 1
BH2	Booster heater 2
BHC1	Contactor for booster heater 1
BHC2	Contactor for booster heater 2
BHCP	Contactor for booster heater protection
TH1	Thermistor (Room temp.)(Option)
TH2	Thermistor (Ref. liquid temp.)
THW1	Thermistor (Flow water temp.)
THW2	Thermistor (Return water temp.)
THW5	Thermistor (DHW tank water temp.)(Option)
THW6	Thermistor (Zone1 flow temp.)(Option)
THW7	Thermistor (Zone1 return temp.)(Option)
THW8	Thermistor (Zone2 flow temp.)(Option)
THW9	Thermistor (Zone2 return temp.)(Option)
THWB1	Thermistor (Boiler flow temp.)(Option)
THWB2	Thermistor (Boiler return temp.)(Option)
IN1	Room thermostat 1 (Local supply)
IN2	Flow switch 1 (Local supply)
IN3	Flow switch 2 (Local supply)
IN4	Demand control (Local supply)
IN5	Outdoor thermostat (Local supply)
IN6	Room thermostat 2 (Local supply)
IN7	Flow switch 3 (Local supply)
IN8	Electric energy meter 1 (Local supply)
IN9	Electric energy meter 2 (Local supply)
IN10	Heat meter (Local supply)
IN11	Smart grid ready input (Local supply)
IN12	Smart grid ready input (Local supply)
IN1A	Flow sensor
FLOW TEMP. CONTROLLER (FTC5)	
TBO.1-4	Terminal block <Outputs>
TBI.1-3	Terminal block <Signal Inputs, Thermistor>
F1	Fuse (IEC T10AL250V)
F2	Fuse (IEC T6.3AL250V)
SW1-5	DIP switch *See <3.2.2 DIP switch functions>.
X1-15	Relay
LED1	Power supply (FTC5)
LED2	Power supply (Main remote controller)
LED3	Communication (FTC5-Outdoor unit)
LED4	Reading or writing data to SD card
CNPWM	Pump speed control signal for MP1
CN108	SD card connector

EHSC-YM9C, EHSC-YM9EC, EHSD-YM9C, EHPX-YM9C

Cylinder / Hydrobox

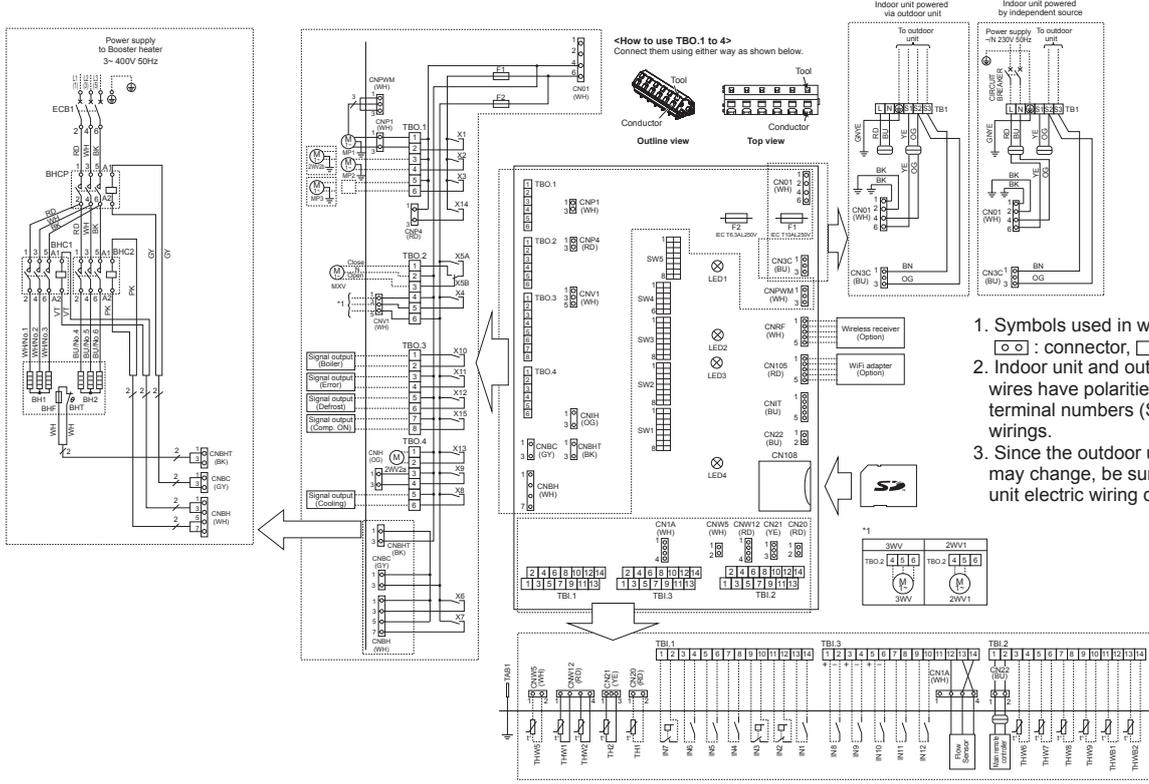

- Symbols used in wiring diagram are, : connector, : terminal block.
- Indoor unit and outdoor unit connecting wires have polarities, make sure to match terminal numbers (S1, S2, S3) for correct wirings.
- Since the outdoor unit side electric wiring may change, be sure to check the outdoor unit electric wiring diagram for service.

Table 1 Signal Inputs

Name	Terminal block	Connector	Item	OFF (Open)	ON (Short)
IN1	TBI.1 13-14	—	Room thermostat 1 input *1	Refer to SW2-1 in <3.2.2 DIP switch functions>.	
IN2	TBI.1 11-12	—	Flow switch 1 input	Refer to SW2-2 in <3.2.2 DIP switch functions>.	
IN3	TBI.1 9-10	—	Flow switch 2 input (Zone1)	Refer to SW3-2 in <3.2.2 DIP switch functions>.	
IN4	TBI.1 7-8	—	Demand control input	Normal	Heat source OFF/ Boiler operation *3
IN5	TBI.1 5-6	—	Outdoor thermostat input *2	Standard operation	Heater operation/ Boiler operation *3
IN6	TBI.1 3-4	—	Room thermostat 2 input *1	Refer to SW3-1 in <3.2.2 DIP switch functions>.	
IN7	TBI.1 1-2	—	Flow switch 3 input (Zone2)	Refer to SW3-3 in <3.2.2 DIP switch functions>.	
IN8	TBI.3 1-2	—	Electric energy meter 1		
IN9	TBI.3 3-4	—	Electric energy meter 2		
IN10	TBI.3 5-6	—	Heat meter		
IN11	TBI.3 7-8	—	Smart grid ready input		
IN12	TBI.3 9-10	—			
IN1A	TBI.3 12-14	CN1A	Flow sensor		

*1. Set the ON/OFF cycle time of the room thermostat for 10 minutes or more; otherwise the compressor may be damaged.
 *2. If using outdoor thermostat for controlling operation of heaters, the lifetime of the heaters and related parts may be reduced.
 *3. To turn on the boiler operation, use the main remote controller to select "Boiler" in "External input setting" screen in the service menu.

Table 2 Outputs

Name	Terminal block	Connector	Item	OFF	ON
OUT1	TBO.1 1-2	CNP1	Water circulation pump 1 output (Space heating/cooling & DHW)	OFF	ON
OUT2	TBO.1 3-4	—	Water circulation pump 2 output (Space heating/cooling for Zone1)	OFF	ON
OUT3	TBO.1 5-6	—	Water circulation pump 3 output (Space heating/cooling for Zone2) *1	OFF	ON
OUT4	TBO.2 4-6	CNV1	3-way valve (2-way valve) output	Heating	DHW
OUT5	TBO.2 1-2	—	Mixing valve output *1	Stop	Close
OUT6	—	CNBH 1-3	Booster heater 1 output	OFF	ON
OUT7	—	CNBH 5-7	Booster heater 2 output	OFF	ON
OUT8	TBO.4 5-6	—	Cooling signal output	OFF	ON
OUT9	TBO.4 3-4	CNIH	Immersion heater output	OFF	ON
OUT10	TBO.3 1-2	—	Boiler output	OFF	ON
OUT11	TBO.3 3-4	—	Error output	Normal	Error
OUT12	TBO.3 5-6	—	Defrost output	Normal	Defrost
OUT13	TBO.4 1-2	—	2-way valve 2a output *2	OFF	ON
OUT14	—	CNP4	Water circulation pump 4 output (DHW)	OFF	ON
OUT15	TBO.3 7-8	—	Comp. ON signal	OFF	ON

Do not connect to the terminals that are indicated as "—" in the "Terminal block" field.
 *1. For 2-zone temperature control.
 *2. For 2-zone valve ON/OFF control.

Symbol	Name
TB1	Terminal block <Power supply, Outdoor unit>
ECB1	Earth leakage circuit breaker for booster heater
MP1	Water circulation pump 1 (Space heating & DHW)
MP2	Water circulation pump 2 (Space heating for Zone1)(Local supply)
MP3	Water circulation pump 3 (Space heating for Zone2)(Local supply)
MP4	Water circulation pump 4 (DHW)(Local supply)
3WV/2WV1	3-way valve (2-way valve 1)(Local supply)
2WV2a	2-way valve (For Zone 1)(Local supply)
2WV2b	2-way valve (For Zone 2)(Local supply)
MXV	Mixing valve (Local supply)
BHT	Thermostat for booster heater
BHF	Thermal fuse for booster heater
BH1	Booster heater 1
BH2	Booster heater 2
BHC1	Contact for booster heater 1
BHC2	Contact for booster heater 2
BHCP	Contact for booster heater protection
TH1	Thermistor (Room temp.)(Option)
TH2	Thermistor (Ref. liquid temp.)
THW1	Thermistor (Flow water temp.)
THW2	Thermistor (Return water temp.)
THW5	Thermistor (DHW tank water temp.)(Option)
THW6	Thermistor (Zone1 flow temp.)(Option)
THW7	Thermistor (Zone1 return temp.)(Option)
THW8	Thermistor (Zone2 flow temp.)(Option)
THW9	Thermistor (Zone2 return temp.)(Option)
THWB1	Thermistor (Boiler flow temp.)(Option)
THWB2	Thermistor (Boiler return temp.)(Option)
IN1	Room thermostat 1 (Local supply)
IN2	Flow switch 1 (Local supply)
IN3	Flow switch 2 (Local supply)
IN4	Demand control (Local supply)
IN5	Outdoor thermostat (Local supply)
IN6	Room thermostat 2 (Local supply)
IN7	Flow switch 3 (Local supply)
IN8	Electric energy meter 1 (Local supply)
IN9	Electric energy meter 2 (Local supply)
IN10	Heat meter (Local supply)
IN11	Smart grid ready input (Local supply)
IN12	
IN1A	Flow sensor
FLOW TEMP. CONTROLLER (FTC5)	
TBO.1-4	Terminal block <Outputs>
TBI.1-3	Terminal block <Signal Inputs, Thermistor>
F1	Fuse (IEC T10AL250V)
F2	Fuse (IEC T6.3AL250V)
SW1-5	DIP switch *See <3.2.2 DIP switch functions>.
X1-15	Relay
LED1	Power supply (FTC5)
LED2	Power supply (Main remote controller)
LED3	Communication (FTC5-Outdoor unit)
LED4	Reading or writing data to SD card
CNPWM	Pump speed control signal for MP1
CN108	SD card connector

EHSC-TM9C

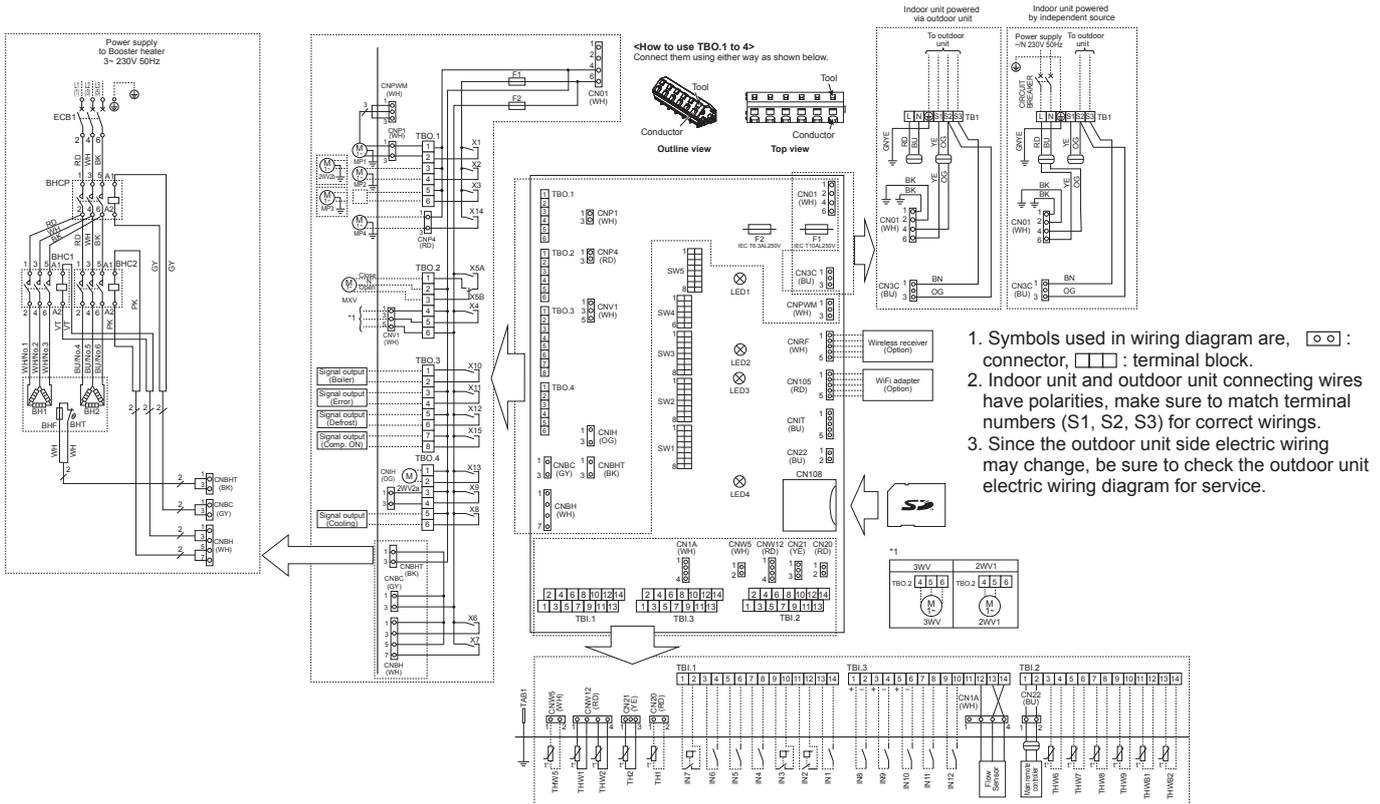

Table 1 Signal Inputs

Name	Terminal block	Connector	Item	OFF (Open)	ON (Short)
IN1	TBI.1 13-14	—	Room thermostat 1 input *1	Refer to SW2-1 in <3.2.2 DIP switch functions>.	
IN2	TBI.1 11-12	—	Flow switch 1 input	Refer to SW2-2 in <3.2.2 DIP switch functions>.	
IN3	TBI.1 9-10	—	Flow switch 2 input (Zone1)	Refer to SW3-2 in <3.2.2 DIP switch functions>.	
IN4	TBI.1 7-8	—	Demand control input	Normal	Heat source OFF/ Boiler operation *3
IN5	TBI.1 5-6	—	Outdoor thermostat input *2	Standard operation	Heater operation/ Boiler operation *3
IN6	TBI.1 3-4	—	Room thermostat 2 input *1	Refer to SW3-1 in <3.2.2 DIP switch functions>.	
IN7	TBI.1 1-2	—	Flow switch 3 input (Zone2)	Refer to SW3-3 in <3.2.2 DIP switch functions>.	
IN8	TBI.3 1-2	—	Electric energy meter 1	Refer to installation manual.	
IN9	TBI.3 3-4	—	Electric energy meter 2		
IN10	TBI.3 5-6	—	Heat meter		
IN11	TBI.3 7-8	—	Smart grid ready input		
IN12	TBI.3 9-10	—	—		
IN1A	TBI.3 12-14	CN1A	Flow sensor		

- *1. Set the ON/OFF cycle time of the room thermostat for 10 minutes or more; otherwise the compressor may be damaged.
- *2. If using outdoor thermostat for controlling operation of heaters, the lifetime of the heaters and related parts may be reduced.
- *3. To turn on the boiler operation, use the main remote controller to select "Boiler" in "External input setting" screen in the service menu.

Table 2 Outputs

Name	Terminal block	Connector	Item	OFF	ON
OUT1	TBO.1 1-2	CNP1	Water circulation pump 1 output (Space heating/cooling & DHW)	OFF	ON
OUT2	TBO.1 3-4	—	Water circulation pump 2 output (Space heating/cooling for Zone1)	OFF	ON
OUT3	TBO.1 5-6	—	Water circulation pump 3 output (Space heating/cooling for Zone2) *1	OFF	ON
OUT4	TBO.2 4-6	CNV1	3-way valve (2-way valve) output	Heating	DHW
OUT5	TBO.2 1-2	—	Mixing valve output *1	Stop	Close
OUT6	—	CNBH 1-3	Booster heater 1 output	OFF	ON
OUT7	—	CNBH 5-7	Booster heater 2 output	OFF	ON
OUT8	TBO.4 5-6	—	Cooling signal output	OFF	ON
OUT9	TBO.4 3-4	CNIH	Immersion heater output	OFF	ON
OUT10	TBO.3 1-2	—	Boiler output	OFF	ON
OUT11	TBO.3 3-4	—	Error output	Normal	Error
OUT12	TBO.3 5-6	—	Defrost output	Normal	Defrost
OUT13	TBO.4 1-2	—	2-way valve 2a output *2	OFF	ON
OUT14	—	CNP4	Water circulation pump 4 output (DHW)	OFF	ON
OUT15	TBO.3 7-8	—	Comp. ON signal	OFF	ON

Do not connect to the terminals that are indicated as "—" in the "Terminal block" field.

- *1. For 2-zone temperature control.
- *2. For 2-zone valve ON/OFF control.

Symbol	Name
TB1	Terminal block <Power supply, Outdoor unit>
ECB1	Earth leakage circuit breaker for booster heater
MP1	Water circulation pump 1 (Space heating & DHW)
MP2	Water circulation pump 2 (Space heating for Zone1)(Local supply)
MP3	Water circulation pump 3 (Space heating for Zone2)(Local supply)
MP4	Water circulation pump 4 (DHW)(Local supply)
3WV/2W1	3-way valve (2-way valve 1)(Local supply)
2WV2a	2-way valve (For Zone 1)(Local supply)
2WV2b	2-way valve (For Zone 2)(Local supply)
MXV	Mixing valve (Local supply)
BHT	Thermostat for booster heater
BHF	Thermal fuse for booster heater
BH1	Booster heater 1
BH2	Booster heater 2
BHC1	Contact for booster heater 1
BHC2	Contact for booster heater 2
BHCP	Contact for booster heater protection
TH1	Thermistor (Room temp.)(Option)
TH2	Thermistor (Ref. liquid temp.)
THW1	Thermistor (Flow water temp.)
THW2	Thermistor (Return water temp.)
THW5	Thermistor (DHW tank water temp.)(Option)
THW6	Thermistor (Zone1 flow temp.)(Option)
THW7	Thermistor (Zone1 return temp.)(Option)
THW8	Thermistor (Zone2 flow temp.)(Option)
THW9	Thermistor (Zone2 return temp.)(Option)
THWB1	Thermistor (Boiler flow temp.)(Option)
THWB2	Thermistor (Boiler return temp.)(Option)
IN1	Room thermostat 1 (Local supply)
IN2	Flow switch 1 (Local supply)
IN3	Flow switch 2 (Local supply)
IN4	Demand control (Local supply)
IN5	Outdoor thermostat (Local supply)
IN6	Room thermostat 2 (Local supply)
IN7	Flow switch 3 (Local supply)
IN8	Electric energy meter 1 (Local supply)
IN9	Electric energy meter 2 (Local supply)
IN10	Heat meter (Local supply)
IN11	Smart grid ready input (Local supply)
IN12	—
IN1A	Flow sensor
FLOW TEMP. CONTROLLER (FTC5)	
TBO.1-4	Terminal block <Outputs>
TBI.1-3	Terminal block <Signal Inputs, Thermistor>
F1	Fuse (IEC T10AL250V)
F2	Fuse (IEC T6.3AL250V)
SW1-5	DIP switch *See <3.2.2 DIP switch functions>.
X1-15	Relay
LED1	Power supply (FTC5)
LED2	Power supply (Main remote controller)
LED3	Communication (FTC5-Outdoor unit)
LED4	Reading or writing data to SD card
CNPWM	Pump speed control signal for MP1
CN108	SD card connector

EHSE-MEC, ERSE-MEC

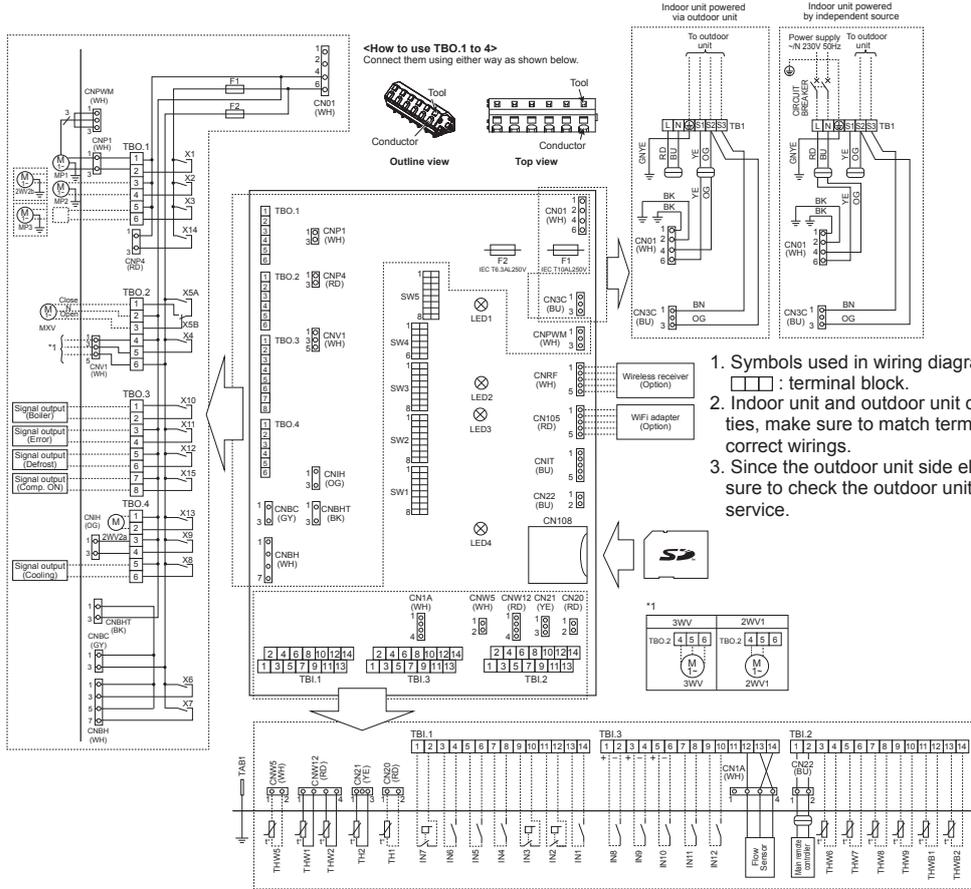

1. Symbols used in wiring diagram are, : connector, : terminal block.
2. Indoor unit and outdoor unit connecting wires have polarities, make sure to match terminal numbers (S1, S2, S3) for correct wirings.
3. Since the outdoor unit side electric wiring may change, be sure to check the outdoor unit electric wiring diagram for service.

Symbol	Name
TB1	Terminal block <Power supply, Outdoor unit>
MP1	Water circulation pump 1 (Space heating/cooling & DHW)
MP2	Water circulation pump 2 (Space heating/cooling for Zone1)(Local supply)
MP3	Water circulation pump 3 (Space heating/cooling for Zone2)(Local supply)
3WV(2WV1)	3-way valve (2-way valve 1)(Local supply)
2WV2a	2-way valve (For Zone 1)(Local supply)
2WV2b	2-way valve (For Zone 2)(Local supply)
MXV	Mixing valve (Local supply)
TH1	Thermistor (Room temp.)(Option)
TH2	Thermistor (Ref. liquid temp.)
THW1	Thermistor (Flow water temp.)
THW2	Thermistor (Return water temp.)
THW5	Thermistor (DHW tank water temp.)(Option)
THW6	Thermistor (Zone1 flow temp.)(Option)
THW7	Thermistor (Zone1 return temp.)(Option)
THW8	Thermistor (Zone2 flow temp.)(Option)
THW9	Thermistor (Zone2 return temp.)(Option)
THWB1	Thermistor (Boiler flow temp.)(Option)
THWB2	Thermistor (Boiler return temp.)(Option)
IN1	Room thermostat 1 (Local supply)
IN2	Flow switch 1 (Local supply)
IN3	Flow switch 2 (Local supply)
IN4	Demand control (Local supply)
IN5	Outdoor thermostat (Local supply)
IN6	Room thermostat 2 (Local supply)
IN7	Flow switch 3 (Local supply)
IN8	Electric energy meter 1 (Local supply)
IN9	Electric energy meter 2 (Local supply)
IN10	Heat meter (Local supply)
IN11	Smart grid ready input (Local supply)
IN12	Flow sensor
IN1A	Flow sensor
FLOW TEMP. CONTROLLER (FTC5)	
TBO.1-4	Terminal block <Outputs>
TBI.1-3	Terminal block <Signal Inputs, Thermistor>
F1	Fuse (IEC T10AL250V)
F2	Fuse (IEC T6.3AL250V)
SW1-5	DIP switch *See "3.2.3 DIP switch setting".
X1-15	Relay
LED1	Power supply (FTC5)
LED2	Power supply (Main remote controller)
LED3	Communication (FTC5-Outdoor unit)
LED4	Reading or writing data to SD card
CNPWM	Pump speed control signal for MP1
CN108	SD card connector

Table 1 Signal Inputs

Name	Terminal block	Connector	Item	OFF (Open)	ON (Short)
IN1	TBI.1 13-14	—	Room thermostat 1 input *1	Refer to SW2-1 in "3.2.3 DIP switch setting".	
IN2	TBI.1 11-12	—	Flow switch 1 input	Refer to SW2-2 in "3.2.3 DIP switch setting".	
IN3	TBI.1 9-10	—	Flow switch 2 input (Zone1)	Refer to SW3-2 in "3.2.3 DIP switch setting".	
IN4	TBI.1 7-8	—	Demand control input	Normal	Heat source OFF/ Boiler operation *3
IN5	TBI.1 5-6	—	Outdoor thermostat input *2	Standard operation	Heater operation/ Boiler operation *3
IN6	TBI.1 3-4	—	Room thermostat 2 input *1	Refer to SW3-1 in "3.2.3 DIP switch setting".	
IN7	TBI.1 1-2	—	Flow switch 3 input (Zone2)	Refer to SW3-3 in "3.2.3 DIP switch setting".	
IN8	TBI.3 1-2	—	Electric energy meter 1	Refer to installation manual.	
IN9	TBI.3 3-4	—	Electric energy meter 2		
IN10	TBI.3 5-6	—	Heat meter		
IN11	TBI.3 7-8	—	Smart grid ready input		
IN12	TBI.3 9-10	—	Flow sensor		
IN1A	TBI.3 12-14	CN1A	Flow sensor		

- *1. Set the ON/OFF cycle time of the room thermostat for 10 minutes or more; otherwise the compressor may be damaged.
- *2. If using outdoor thermostat for controlling operation of heaters, the lifetime of the heaters and related parts may be reduced.
- *3. To turn on the boiler operation, use the main remote controller to select "Boiler" in "External input setting" screen in the service menu.

Table 2 Outputs

Name	Terminal block	Connector	Item	OFF	ON
OUT1	TBO.1 1-2	CNP1	Water circulation pump 1 output (Space heating/cooling & DHW)	OFF	ON
OUT2	TBO.1 3-4	—	Water circulation pump 2 output (Space heating/cooling for Zone1)	OFF	ON
OUT3	TBO.1 5-6	—	Water circulation pump 3 output (Space heating/cooling for Zone2) *1 2-way valve 2b output *2	OFF	ON
OUT4	TBO.2 4-6	CNV1	3-way valve (2-way valve) output	Heating	DHW
OUT5	TBO.2 1-2 TBO.2 2-3	—	Mixing valve output *1	Stop	Close Open
OUT6	—	CNBH 1-3	Booster heater 1 output	OFF	ON
OUT7	—	CNBH 5-7	Booster heater 2 output	OFF	ON
OUT8	TBO.4 5-6	—	Cooling signal output	OFF	ON
OUT9	TBO.4 3-4	CNIH	Immersion heater output	OFF	ON
OUT10	TBO.3 1-2	—	Boiler output	OFF	ON
OUT11	TBO.3 3-4	—	Error output	Normal	Error
OUT12	TBO.3 5-6	—	Defrost output	Normal	Defrost
OUT13	TBO.4 1-2	—	2-way valve 2a output *2	OFF	ON
OUT14	—	CNP4	Water circulation pump 4 output (DHW)	OFF	ON
OUT15	TBO.3 7-8	—	Comp. ON signal	OFF	ON

Do not connect to the terminals that are indicated as "—" in the "Terminal block" field.

- *1. For 2-zone temperature control.
- *2. For 2-zone valve ON/OFF control.

3.2.2 Dip switch functions (1) (Hydrobox, except for EHSE/ERSE series)

Located on the FTC printed circuit board are 5 sets of small white switches known as DIP switches. The DIP switch number is printed on the circuit board next to the relevant switches. The word ON is printed on the circuit board and on the DIP switch block itself. To move the switch you will need to use a pin or the corner of a thin metal ruler or similar.

DIP switch settings are listed in the table below.
Only an authorised installer can change DIP switch setting under one's own responsibility according to the installation condition.
Make sure to turn off both indoor unit and outdoor unit power supplies before changing the switch settings.

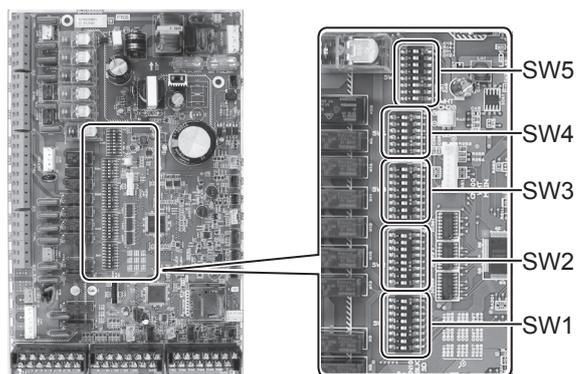

<Figure 3.2.1>

DIP switch	Function	OFF	ON	Default settings: Indoor unit model			
SW1	SW1-1	Boiler	WITHOUT Boiler	WITH Boiler	OFF		
	SW1-2	Heat pump maximum outlet water temperature	55°C	60°C	ON *1		
	SW1-3	DHW tank	WITHOUT DHW tank	WITH DHW tank	OFF		
	SW1-4	Immersion heater	WITHOUT Immersion heater	WITH Immersion heater	OFF		
	SW1-5	Booster heater	WITHOUT Booster heater	WITH Booster heater	OFF: E***-M°C ON : E***-M2/6/9C		
	SW1-6	Booster heater function	For heating only	For heating and DHW	OFF: E***-M°C ON : E***-M2/6/9C		
	SW1-7	Outdoor unit type	Split type	Packaged type	OFF: E*S*-M°C ON : EHPX-*M°C		
	SW1-8	Wireless remote controller	WITHOUT Wireless remote controller	WITH Wireless remote controller	OFF		
SW2	SW2-1	Room thermostat1 input (IN1) logic change	Zone1 operation stop at thermostat short	Zone1 operation stop at thermostat open	OFF		
	SW2-2	Flow switch1 input (IN2) logic change	Failure detection at short	Failure detection at open	OFF		
	SW2-3	Booster heater capacity restriction	Inactive	Active	OFF: Except E***-VM2°C ON : E***-VM2°C		
	SW2-4	Cooling mode function	Inactive	Active	OFF: Except ERS*-M**C ON : ERS*-M**C		
	SW2-5	Automatic switch to backup heat source operation (When outdoor unit stops by error)	Inactive	Active *2	OFF		
	SW2-6	Mixing tank	WITHOUT Mixing tank	WITH Mixing tank	OFF		
	SW2-7	2-zone temperature control	Inactive	Active *6	OFF		
	SW2-8	Flow sensor	WITHOUT Flow sensor	WITH Flow sensor	ON		
SW3	SW3-1	Room thermostat 2 input (IN6) logic change	Zone2 operation stop at thermostat short	Zone2 operation stop at thermostat open	OFF		
	SW3-2	Flow switch 2 input (IN3) logic change	Failure detection at short	Failure detection at open	OFF		
	SW3-3	Flow switch 3 input (IN7) logic change	Failure detection at short	Failure detection at open	OFF		
	SW3-4	Electric energy meter	WITHOUT Electric energy meter	WITH Electric energy meter	OFF		
	SW3-5	Heating mode function *3	Inactive	Active	ON		
	SW3-6	2-zone valve ON/OFF control	Inactive	Active	OFF		
	SW3-7	Heat exchanger for DHW	Coil in tank	External plate HEX	OFF		
	SW3-8	Heat meter	WITHOUT Heat meter	WITH Heat meter	OFF		
SW4	SW4-1	Multiple outdoor units control	Inactive	Active	OFF		
	SW4-2	Position of multiple outdoor units control *7	Slave	Master	OFF		
	SW4-3	—	—	—	OFF		
	SW4-4	Indoor unit only operation (during installation work) *4	Inactive	Active	OFF		
	SW4-5	Emergency mode (Heater only operation)	Normal	Emergency mode (Heater only operation)	OFF *5		
	SW4-6	Emergency mode (Boiler operation)	Normal	Emergency mode (Boiler operation)	OFF *5		
SW5	SW5-1	DHW tank water temperature over heat protection (L4)	Active	Inactive *8	OFF		
	SW5-2	Advanced auto adaptation *9	Inactive	Active	OFF: Other than R1/R2 models ON: R1/R2 models		
	SW5-3	Capacity code					
	SW5-4		SW5-3	SW5-4	SW5-5	SW5-6	SW5-7
	SW5-5	E*SC-*M°C	ON	ON	ON	ON	OFF
	SW5-6	E*SD-*M°C	ON	OFF	OFF	ON	OFF
	SW5-7	EHPX-*M°C	OFF	OFF	OFF	OFF	OFF
	SW5-8	—	—	—	—	—	OFF

<Table 3.2.1>

Notes:

- *1. When the hydrobox is connected with a PUMY-P/SUHZ-SW outdoor unit of which maximum outlet water temperature is 55°C, DIP SW1-2 must be changed to OFF.
- *2. OUT11 will be available. For safety reasons, this function is not available for certain errors. (In that case, system operation must be stopped and only the water circulation pump keeps running.)
- *3 This switch functions only when the hydrobox is connected with a PUIHZ-FRP outdoor unit. When another type of outdoor unit is connected, the heating mode function is active regardless of the fact that this switch is ON or OFF.
- *4. Space heating and DHW can be operated only in indoor unit, like an electric boiler. (Refer to "5.5 Indoor unit only operation" in Installation Manual.)
- *5. If emergency mode is no longer required, return the switch to OFF position.
- *6. Active only when SW3-6 is set to OFF.
- *7. Active only when SW4-1 is set to ON.
- *8. Please make sure to have necessary overheat protection on locally supplied solar thermal system side to secure safety, as the tank temperature could be much higher (than current).
- *9. SW5-2, "Advanced auto adaptation" is available only for R1 and R2 models.

3.2.3 Dip switch functions (2) (Hydrobox, EHSE/ERSE series)

Located on the FTC printed circuit board are 5 sets of small white switches known as DIP switches. The DIP switch number is printed on the circuit board next to the relevant switches. The word ON is printed on the circuit board and on the DIP switch block itself. To move the switch you will need to use a pin or the corner of a thin metal ruler or similar.

DIP switch settings are listed in the table below.

Only an authorised installer can change DIP switch setting under one's own responsibility according to the installation condition.

Make sure to turn off both indoor unit and outdoor unit power supplies before changing the switch settings.

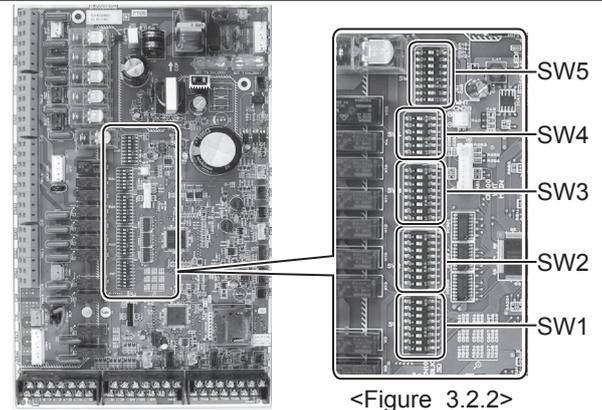

<Figure 3.2.2>

DIP switch	Function	OFF	ON	Default settings: Indoor unit model
SW1	SW1-1 Boiler	WITHOUT Boiler	WITH Boiler	OFF
	SW1-2 Heat pump maximum outlet water temperature	55°C	60°C	ON *1
	SW1-3 DHW tank	WITHOUT DHW tank	WITH DHW tank	OFF
	SW1-4 Immersion heater	WITHOUT Immersion heater	WITH Immersion heater	OFF
	SW1-5 Booster heater	WITHOUT Booster heater	WITH Booster heater	OFF: E*SE-MEC ON: E*SE-YM9EC
	SW1-6 Booster heater function	For heating only	For heating and DHW	OFF: E*SE-MEC ON: E*SE-YM9EC
	SW1-7 Outdoor unit type	Split type	Packaged type	OFF
	SW1-8 Wireless remote controller	WITHOUT Wireless remote controller	WITH Wireless remote controller	OFF
SW2	SW2-1 Room thermostat1 input (IN1) logic change	Zone1 operation stop at thermostat short	Zone1 operation stop at thermostat open	OFF
	SW2-2 Flow switch1 input (IN2) logic change	Failure detection at short	Failure detection at open	OFF
	SW2-3 Booster heater capacity restriction	Inactive	Active	OFF
	SW2-4 Cooling mode function	Inactive	Active	OFF: EHSE-*M*EC ON: ERSE-*M*EC
	SW2-5 Automatic switch to backup heat source operation (When outdoor unit stops by error)	Inactive	Active *2	OFF
	SW2-6 Mixing tank	WITHOUT Mixing tank	WITH Mixing tank	OFF
	SW2-7 2-zone temperature control	Inactive	Active *6	OFF
	SW2-8 Flow sensor	WITHOUT Flow sensor	WITH Flow sensor	ON
SW3	SW3-1 Room thermostat 2 input (IN6) logic change	Zone2 operation stop at thermostat short	Zone2 operation stop at thermostat open	OFF
	SW3-2 Flow switch 2 input (IN3) logic change	Failure detection at short	Failure detection at open	OFF
	SW3-3 Flow switch 3 input (IN7) logic change	Failure detection at short	Failure detection at open	OFF
	SW3-4 Electric energy meter	WITHOUT Electric energy meter	WITH Electric energy meter	OFF
	SW3-5 Heating mode function *3	Inactive	Active	ON
	SW3-6 2-zone valve ON/OFF control	Inactive	Active	OFF
	SW3-7 Heat exchanger for DHW	Coil in tank	External plate HEX	OFF
	SW3-8 Heat meter	WITHOUT Heat meter	WITH Heat meter	OFF
SW4	SW4-1 Multiple outdoor units control	Inactive	Active	OFF
	SW4-2 Position of multiple outdoor units control *7	Slave	Master	OFF
	SW4-3	—	—	OFF
	SW4-4 Indoor unit only operation (during installation work) *4	Inactive	Active	OFF
	SW4-5 Emergency mode (Heater only operation)	Normal	Emergency mode (Heater only operation)	OFF *5
	SW4-6 Emergency mode (Boiler operation)	Normal	Emergency mode (Boiler operation)	OFF *5
SW5	SW5-1	—	—	OFF
	SW5-2 Advanced auto adaptation *8	Inactive	Active	OFF: Other than R1/R2 models ON: R1/R2 models
	SW5-3	—	—	OFF
	SW5-4	—	—	ON
	SW5-5 Capacity code	—	—	ON
	SW5-6	—	—	OFF
	SW5-7	—	—	ON
	SW5-8	—	—	OFF

<Table 3.2.2>

*1 When the hydrobox is connected with a outdoor unit of which maximum outlet water temperature is 55°C, DIP SW1-2 must be changed to OFF.

*2 OUT11 will be available. For safety reasons, this function is not available for certain errors. (In that case, system operation must be stopped and only the water circulation pump keeps running.)

*3 This switch functions only when the hydrobox is connected with a PUHZ-FRP outdoor unit. When another type of outdoor unit is connected, the heating mode function is active regardless of the fact that this switch is ON or OFF.

*4 Space heating and DHW can be operated only in indoor unit, like an electric boiler. (Refer to "5.5 Indoor unit only operation" in Installation Manual.)

*5 If emergency mode is no longer required, return the switch to OFF position.

*6 Active only when SW3-6 is set to OFF.

*7 Active only when SW4-1 is set to ON.

*8. SW5-2, "Advanced auto adaptation" is available for R1 and R2 models.

Automatic switch to heat source only operation

Back-up heat source operation (*1) will automatically run when the outdoor unit stops abnormally. To enable the function, switch DIP SW 2-5 to ON. During the back-up operation, an error code(s) and the contact number will be displayed alternately. External output (OUT11) will be available. To clear the fault(s), reset the power breakers on the indoor and outdoor units.

<Applicable error codes (*2)>

E6 to E9, ED, P6, P8, U1 to U8, UD, UE, UF, UL, UP

(*1) Prolonged running of the back-up operation may affect the life of the heat source.

(*2) For safety reasons, this function is not available for certain faults. (System operation must be stopped and only pump keeps running.)

3.2.4 Connecting inputs/outputs (Hydrobox)

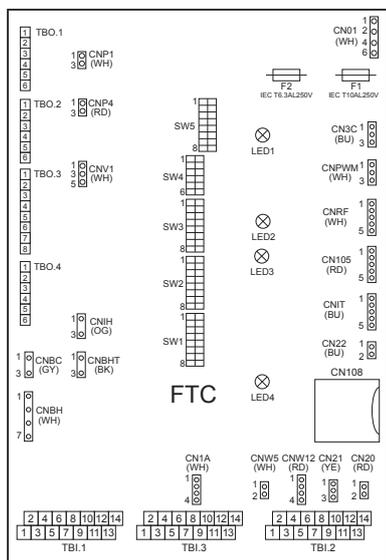

When the wires are wired to adjacent terminals use ring terminals and insulate the wires.

<Figure 3.2.3>

Signal inputs

Name	Terminal block	Connector	Item	OFF (Open)	ON (Short)
IN1	TBI.1 13-14	—	Room thermostat 1 input *1	Refer to SW2-1 in <5.1 DIP Switch Functions>.	
IN2	TBI.1 11-12	—	Flow switch 1 input	Refer to SW2-2 in <5.1 DIP Switch Functions>.	
IN3	TBI.1 9-10	—	Flow switch 2 input (Zone1)	Refer to SW3-2 in <5.1 DIP Switch Functions>.	
IN4	TBI.1 7-8	—	Demand control input	Normal	Heat source OFF/ Boiler operation *3
IN5	TBI.1 5-6	—	Outdoor thermostat input *2	Standard operation	Heater operation/ Boiler operation *3
IN6	TBI.1 3-4	—	Room thermostat 2 input *1	Refer to SW3-1 in <5.1 DIP Switch Functions>.	
IN7	TBI.1 1-2	—	Flow switch 3 input (Zone2)	Refer to SW3-3 in <5.1 DIP Switch Functions>.	
IN8	TBI.3 1-2	—	Electric energy meter 1	*4	
IN9	TBI.3 3-4	—	Electric energy meter 2		
IN10	TBI.3 5-6	—	Heat meter		
IN11	TBI.3 7-8	—	Smart grid ready input	*5	
IN12	TBI.3 9-10	—			
IN1A	TBI.3 12-14	CN1A	Flow sensor	—	—

*1. Set the ON/OFF cycle time of the room thermostat for 10 minutes or more; otherwise the compressor may be damaged.

*2. If using outdoor thermostat for controlling operation of heaters, the lifetime of the heaters and related parts may be reduced.

*3. To turn on the boiler operation, use the main remote controller to select "Boiler" in "External input setting" screen in the service menu.

*4. Connectable electric energy meter and heat meter

- Pulse type Voltage free contact for 12VDC detection by FTC (TBI.3 1, 3 and 5 pins have a positive voltage.)
- Pulse duration Minimum ON time: 40ms
Minimum OFF time: 100ms
- Possible unit of pulse 0.1 pulse/kWh 1 pulse/kWh 10 pulse/kWh
100 pulse/kWh 1000 pulse/kWh

Those values can be set by the main remote controller. (Refer to the menu tree in "6. System Set Up".)

*5. As for the smart grid ready, refer to "5.6 Smart grid ready" in Installation Manual.

Wiring specification and local supply parts

Item	Name	Model and specifications
Signal input function	Signal input wire	Use sheathed vinyl coated cord or cable. Max. 30 m Wire type: CV, CVS or equivalent Wire size: Stranded wire 0.13 mm ² to 1.25 mm ² Solid wire: ø0.4 mm to ø1.2 mm
	Switch	Non-voltage "a" contact signals Remote switch: minimum applicable load 12V DC, 1mA

■ Thermistor inputs

Name	Terminal block	Connector	Item	Optional part model
TH1	—	CN20	Thermistor (Room temp.) (Option)	PAC-SE41TS-E
TH2	—	CN21	Thermistor (Ref. liquid temp.)	—
THW1	—	CNW12 1-2	Thermistor (Flow water temp.)	—
THW2	—	CNW12 3-4	Thermistor (Return water temp.)	—
THW5	—	CNW5	Thermistor (DHW tank water temp.) (Option) *1	PAC-TH011TK-E (5 m) / PAC-TH011TKL-E (30 m)
THW6	TBI.2 3-4	—	Thermistor (Zone1 flow water temp.) (Option) *1	PAC-TH011-E
THW7	TBI.2 5-6	—	Thermistor (Zone1 return water temp.) (Option) *1	—
THW8	TBI.2 7-8	—	Thermistor (Zone2 flow water temp.) (Option) *1	PAC-TH011-E
THW9	TBI.2 9-10	—	Thermistor (Zone2 return water temp.) (Option) *1	—
THWB1	TBI.2 11-12	—	Thermistor (Boiler flow water temp.) (Option) *1	PAC-TH011HT-E
THWB2	TBI.2 13-14	—	Thermistor (Boiler return water temp.) (Option) *1	—

Ensure to wire thermistor wirings away from the power line and/or OUT1 to 15 wirings.

*1. The maximum length of the thermistor wiring is 30 m. When the wires are wired to adjacent terminals, use ring terminals and insulate the wires. The length of the optional thermistors are 5 m. If you need to splice and extend the wirings, following points must be carried out.

- 1) Connect the wirings by soldering.
- 2) Insulate each connecting point against dust and water.

■ Outputs

Name	Terminal block	Connector	Item	OFF	ON	Signal/Max. current	Max. total current	
OUT1	TBO.1 1-2	CNP1	Water circulation pump 1 output (Space heating/cooling & DHW)	OFF	ON	230V AC 1.0A Max.	4.0A (a)	
OUT2	TBO.1 3-4	—	Water circulation pump 2 output (Space heating/cooling for Zone1)	OFF	ON	230V AC 1.0A Max.		
OUT3	TBO.1 5-6	—	Water circulation pump 3 output (Space heating/cooling for Zone2) *2 2-way valve 2b output *3	OFF	ON	230V AC 1.0A Max.		
OUT14 *1	—	CNP4	Water circulation pump 4 output (DHW)	OFF	ON	230V AC 1.0A Max.	3.0A (b)	
OUT4	TBO.2 4-6	CNV1	3-way valve (2-way valve 1) output	Heating	DHW	230V AC 0.1A Max.		
OUT5	TBO.2 1-2 TBO.2 2-3	—	Mixing valve output *2	Stop	Close Open	230V AC 0.1A Max.		
OUT6	—	CNBH 1-3	Booster heater 1 output	OFF	ON	230V AC 0.5A Max. (Relay)		
OUT7	—	CNBH 5-7	Booster heater 2 output	OFF	ON	230V AC 0.5A Max. (Relay)		
OUT8	TBO.4 5-6	—	Cooling signal output	OFF	ON	230V AC 0.5A Max.		
OUT9	TBO.4 3-4	CNIH	Immersion heater output	OFF	ON	230V AC 0.5A Max. (Relay)		
OUT11	TBO.3 3-4	—	Error output	Normal	Error	230V AC 0.5A Max.		
OUT12	TBO.3 5-6	—	Defrost output	Normal	Defrost	230V AC 0.5A Max.		
OUT13	TBO.4 1-2	—	2-way valve 2a output *3	OFF	ON	230V AC 0.1A Max.		
OUT15	TBO.3 7-8	—	Comp ON signal	OFF	ON	230V AC 0.5A Max.		
OUT10	TBO.3 1-2	—	Boiler output	OFF	ON	non-voltage contact · 220-240V AC (30V DC) · 0.5A or less · 10mA 5V DC or more		—

Do not connect to the terminals that are indicated as “—” in the “Terminal block” field.

*1 Except for EHSE/ERSE series.

*2 For 2-zone temperature control.

*3 For 2-zone valve ON/OFF control.

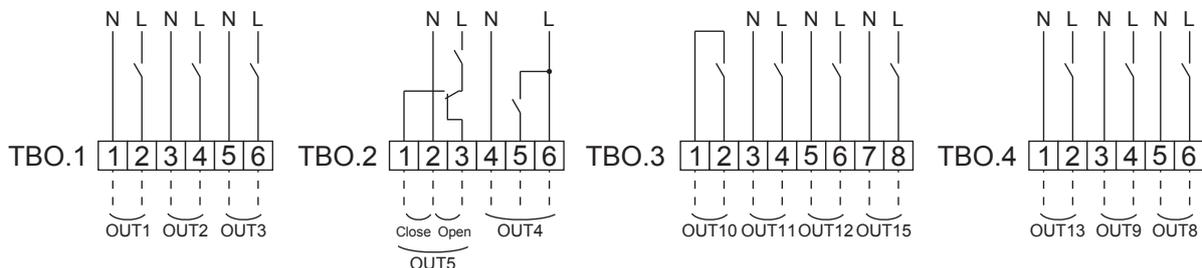

Wiring specification and local supply parts

Item	Name	Model and specifications
External output function	Outputs wire	Use sheathed vinyl coated cord or cable. Max. 30 m Wire type: CV, CVS or equivalent Wire size: Stranded wire 0.25 mm ² to 1.5 mm ² Solid wire: 0.25 mm ² to 1.5 mm ²

Note:

1. When the hydrobox is powered via outdoor unit, the maximum grand total current of (a)+(b) is 3.0 A.
2. Do not connect multiple water circulation pumps directly to each output (OUT1, OUT2, and OUT3). In such a case, connect them via (a) relay(s).
3. Do not connect water circulation pumps to both TBO.1 1-2 and CNP1 at the same time.
4. Connect an appropriate surge absorber to OUT10 (TBO.3 1-2) depending on the load at site.
5. Stranded wire should be processed with insulation-covered bar terminal (DIN46228-4 standard compatible type).

How to use TBO.1 to 4

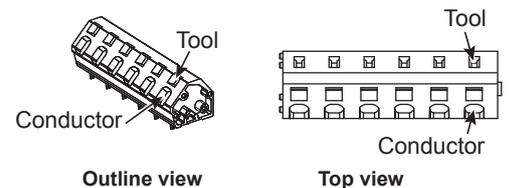

Connect them using either way as shown above.

3.2.5 Electrical Connection

All electrical work should be carried out by a suitably qualified technician. Failure to comply with this could lead to electrocution, fire, and death. It will also invalidate product warranty. All wiring should be according to national wiring regulations.

Breaker abbreviation	Meaning
ECB1	Earth leakage circuit breaker for booster heater
TB1	Terminal block 1

Except for EHSE/ERSE series

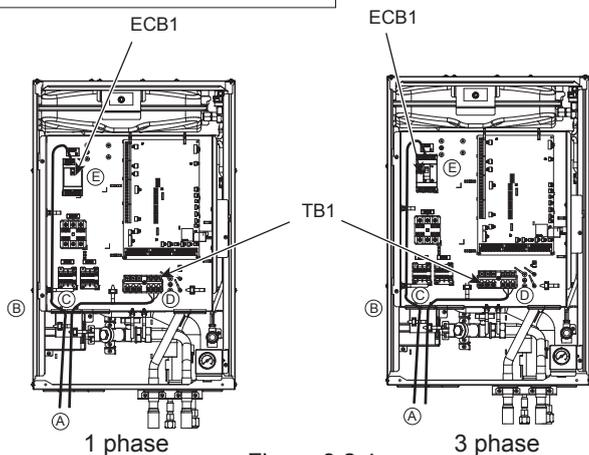

<Figure 3.2.4>

EHSE/ERSE series

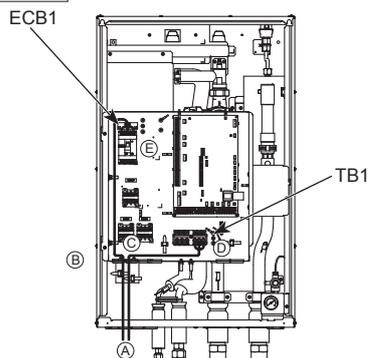

<Figure 3.2.5>

The hydrobox can be powered in two ways.

1. Power cable is run from the outdoor unit to the hydrobox.
2. Hydrobox has independent power source.

Connections should be made to the terminals indicated in the figures to the left below depending on the phase.

Booster heater and immersion heater should be connected independently from one another to dedicated power supplies.

- Locally supplied wiring should be inserted through the inlets situated on the base of the hydrobox. (Refer to <Table 2.2.1 and 2.2.2>.
- Wiring should be fed down the left hand side of the control and electrical box and clamped in place using clips provided.
- The wires should be inserted individually through the cable inlets as below.
 - Power line (B.H.)
 - Power line (I.H.) (option)
 - Indoor-Outdoor wire
 - Output wires
 - Signal input wires
 - Wireless receiver (option) wire (PAR-WR51R-E)
- Connect the outdoor unit – hydrobox connecting cable to TB1.
- Connect the power cable for the booster heater to ECB1.

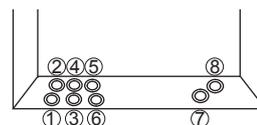

• Make sure that ECB1 is ON.

Hydrobox NOTICE

1. When the hydrobox leaves the factory, the main remote controller cable (Fig. 3.2.6) on the main unit is not connected to the controller's relay connector (Fig. 3.2.7) on the front panel. After completing installation and wiring in the field, connect the main remote controller cable to the relay connector, then turn on the power.

2. Before setting up the system, insert the included SD memory card. (For more details, refer to section 3.3.)

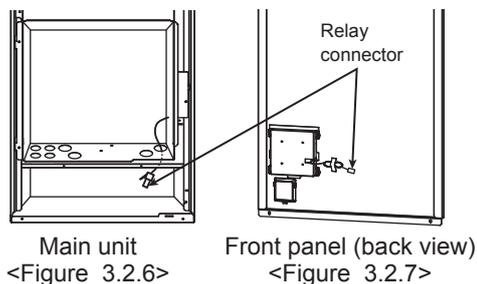

Main unit
<Figure 3.2.6>

Front panel (back view)
<Figure 3.2.7>

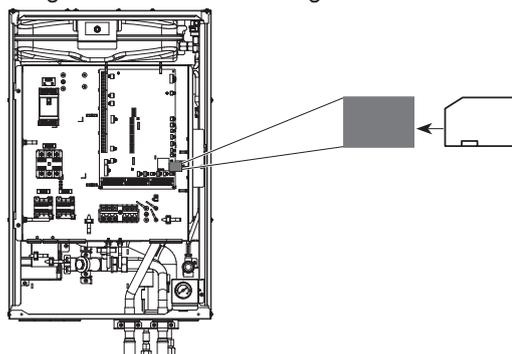

Main unit
<Figure 3.2.8>

Except for EHSE/ERSE series

Option 1: Hydrobox powered via outdoor unit

<1 phase>

Affix label A that is included with the manuals near each wiring diagram for hydrobox and outdoor units.

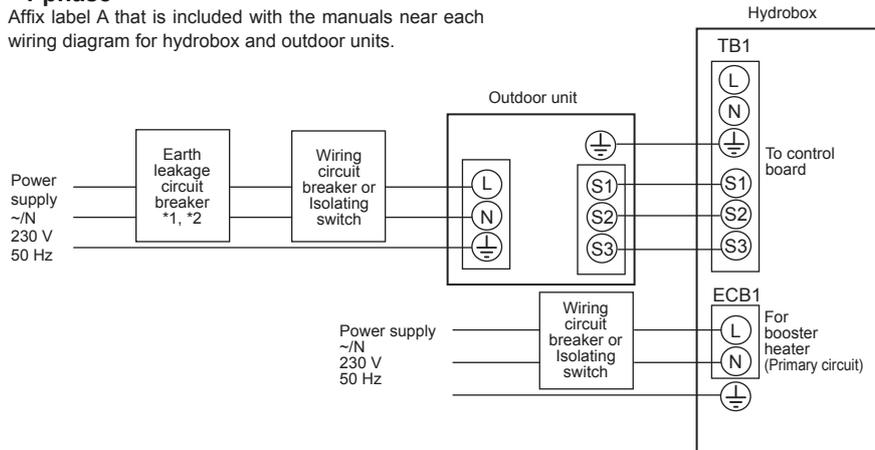

*1 If the installed earth leakage circuit breaker does not have an over-current protection function, install a breaker with that function along the same power line.

Description	Power supply	Capacity	Breaker	Wiring
Booster heater (Primary circuit)	~N 230 V	2 kW	16 A *2	2.5 mm ²
	50 Hz	6 kW	32 A *2	6.0 mm ²

<Figure 3.2.9>
Electrical connections 1 phase

<3 phase>

Affix label A that is included with the manuals near each wiring diagram for hydrobox and outdoor units.

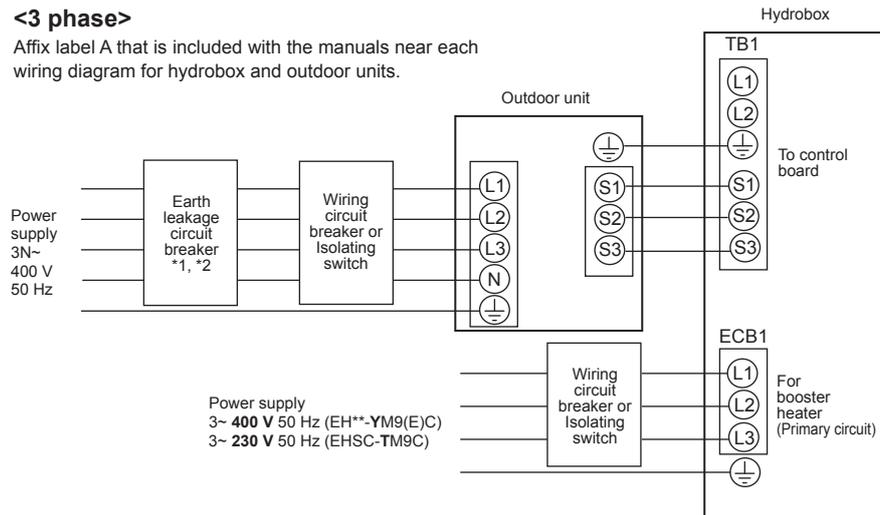

*1 If the installed earth leakage circuit breaker does not have an over-current protection function, install a breaker with that function along the same power line.

Description	Power supply	Capacity	Breaker	Wiring
Booster heater (Primary circuit)	3~ 400 V	9 kW	16 A *2	2.5 mm ²
	50 Hz			
	3~ 230 V	9 kW	32 A *2	6.0 mm ²
	50 Hz			

<Figure 3.2.10>
Electrical connections 3 phase

Wiring No. x size (mm ²)	Hydrobox - Outdoor unit	*3	3 × 1.5 (polar)
	Hydrobox - Outdoor unit earth	*3	1 × Min. 1.5
Circuit rating	Hydrobox - Outdoor unit S1 - S2	*4	230 V AC
	Hydrobox - Outdoor unit S2 - S3	*4	24 V DC

*2. A breaker with at least 3.0 mm contact separation in each pole shall be provided. Use earth leakage breaker (NV). The breaker shall be provided to ensure disconnection of all active phase conductors of the supply.

*3. Max. 45 m

If 2.5 mm² used, Max. 50 m

If 2.5 mm² used and S3 separated, Max. 80 m

*4. The values given in the table above are not always measured against the ground value.

- Notes:**
1. Wiring size must comply with the applicable local and national codes.
 2. Indoor unit/outdoor unit connecting cords shall not be lighter than polychloroprene sheathed flexible cord. (Design 60245 IEC 57)
Indoor unit power supply cords shall not be lighter than polychloroprene sheathed flexible cord. (Design 60227 IEC 53)
 3. Install an earth longer than other cables.
 4. Please keep enough output capacity of power supply for each heater. Insufficient power supply capacity might cause chattering.

Except for EHSE/ERSE series

Option2: Hydrobox powered by independent source

If the hydrobox and outdoor units have separate power supplies, the following requirements MUST be carried out:

- Change connector connections in hydrobox control and electrical box (see Figure 3.2.11).
- Turn the outdoor unit DIP switch SW8-3 to ON.
- Turn on the outdoor unit BEFORE the hydrobox.
- Power by independent source is not available for particular models of outdoor unit model.

For more detail, refer to the connecting outdoor unit installation manual.

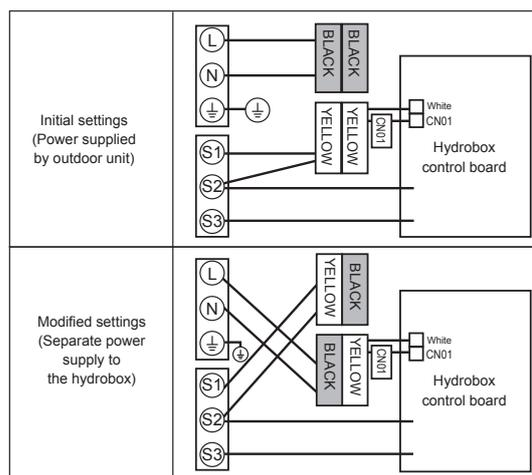

<Figure 3.2.11>

<1 phase>

Affix label B that is included with the manuals near each wiring diagram for hydrobox and outdoor units.

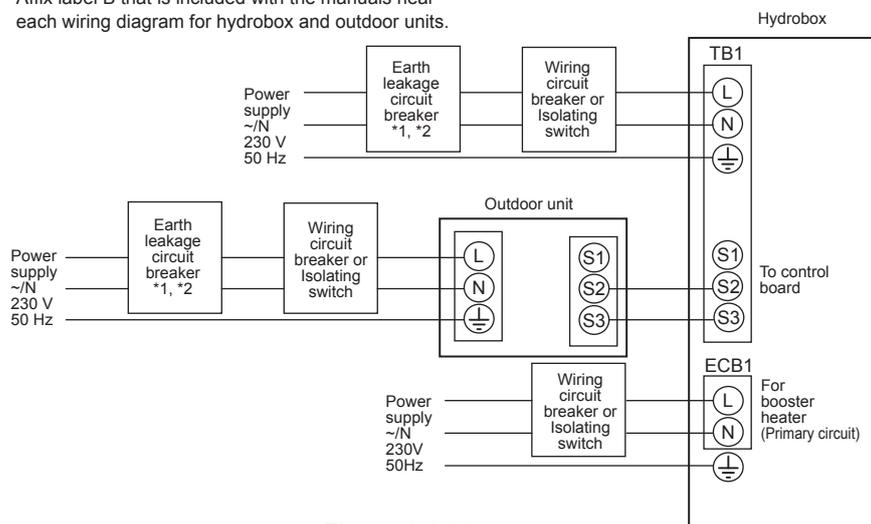

<Figure 3.2.12>

Electrical connections 1 phase

*1 If the installed earth leakage circuit breaker does not have an over-current protection function, install a breaker with that function along the same power line.

Description	Power supply	Capacity	Breaker	Wiring
Booster heater (Primary circuit)	~N 230 V 50 Hz	2 kW	16 A *2	2.5 mm ²
		6 kW	32 A *2	6.0 mm ²

Hydrobox power supply		~N 230 V 50 Hz
Hydrobox input capacity	*2	16 A
Main switch (Breaker)		
Wiring No. x size (mm ²)	Hydrobox power supply	2 x Min. 1.5
	Hydrobox power supply earth	1 x Min. 1.5
	Hydrobox - Outdoor unit	*3 2 x Min. 0.3
	Hydrobox - Outdoor unit earth	—
Circuit rating	Hydrobox L - N	*4 230 V AC
	Hydrobox - Outdoor unit S1 - S2	*4 —
	Hydrobox - Outdoor unit S2 - S3	*4 24 V DC

*2. A breaker with at least 3.0 mm contact separation in each pole shall be provided. Use earth leakage breaker (NV).

The breaker shall be provided to ensure disconnection of all active phase conductors of the supply.

*3. Max. 120 m

*4. The values given in the table above are not always measured against the ground value.

Notes: 1. Wiring size must comply with the applicable local and national codes.

2. Indoor unit/outdoor unit connecting cords shall not be lighter than polychloroprene sheathed flexible cord. (Design 60245 IEC 57)

Indoor unit power supply cords shall not be lighter than polychloroprene sheathed flexible cord. (Design 60227 IEC 53)

3. Install an earth longer than other cables.

4. Please keep enough output capacity of power supply for each heater. Insufficient power supply capacity might cause chattering.

Except for EHSE/ERSE series

<3 phase>

Affix label B that is included with the manuals near each wiring diagram for hydrobox and outdoor units.

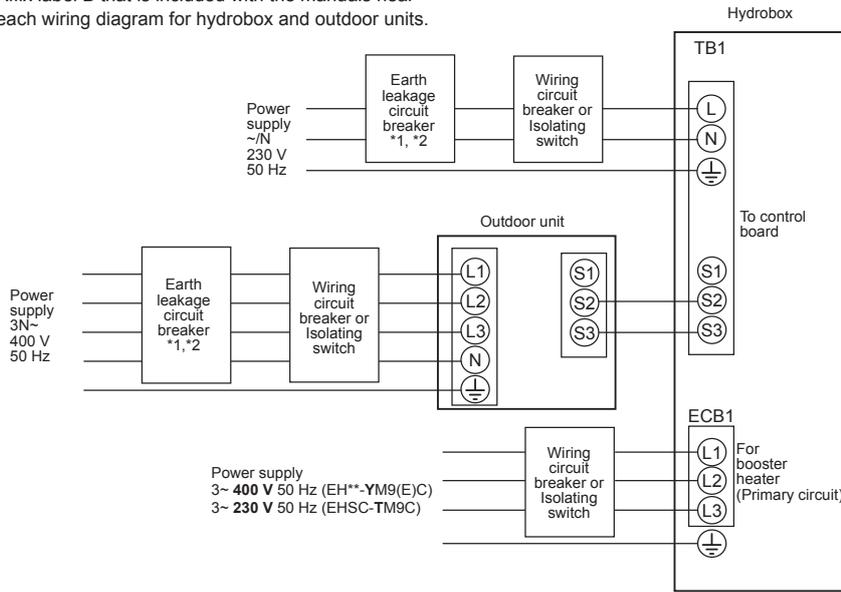

*1 If the installed earth leakage circuit breaker does not have an over-current protection function, install a breaker with that function along the same power line.

Description	Power supply	Capacity	Breaker	Wiring
Booster heater (Primary circuit)	3~ 400 V 50 Hz	9 kW	16 A *2	2.5 mm ²
	3~ 230 V 50 Hz	9 kW	32 A *2	6.0 mm ²

<Figure 3.2.13>
Electrical connections 3 phase

Hydrobox power supply		~N 230 V 50 Hz
Hydrobox input capacity Main switch (Breaker)		*2 16 A
Wiring No. x size (mm ²)	Hydrobox power supply	2 x Min. 1.5
	Hydrobox power supply earth	1 x Min. 1.5
Circuit rating	Hydrobox - Outdoor unit	*3 2 x Min. 0.3
	Hydrobox - Outdoor unit earth	—
Circuit rating	Hydrobox L - N	*4 230 V AC
	Hydrobox - Outdoor unit S1 - S2	*4 —
	Hydrobox - Outdoor unit S2 - S3	*4 24 V DC

*2. A breaker with at least 3.0 mm contact separation in each pole shall be provided. Use earth leakage breaker (NV). The breaker shall be provided to ensure disconnection of all active phase conductors of the supply.

*3. Max. 120 m

*4. The values given in the table above are not always measured against the ground value.

- Notes:**
1. Wiring size must comply with the applicable local and national codes.
 2. Indoor unit/outdoor unit connecting cords shall not be lighter than polychloroprene sheathed flexible cord. (Design 60245 IEC 57)
Indoor unit power supply cords shall not be lighter than polychloroprene sheathed flexible cord. (Design 60227 IEC 53)
 3. Install an earth longer than other cables.
 4. Please keep enough output capacity of power supply for each heater. Insufficient power supply capacity might cause chattering.

EHSE/ERSE series

Option 1: Hydrobox powered via outdoor unit

<1 phase>

Affix label A that is included with the manuals near each wiring diagram for hydrobox and outdoor units.

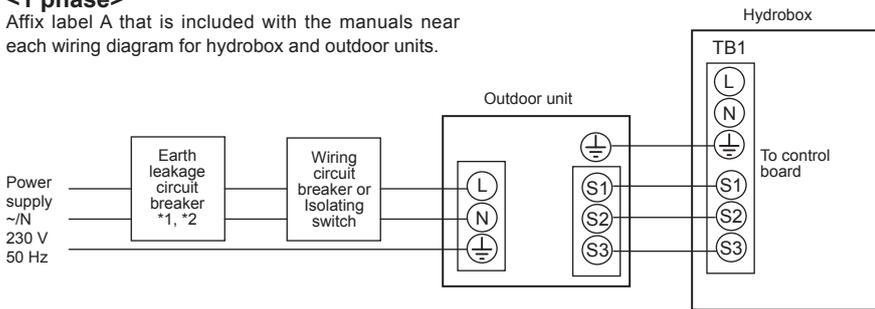

*1 If the installed earth leakage circuit breaker does not have an over-current protection function, install a breaker with that function along the same power line.

<Figure 3.2.14>
Electrical connections 1 phase

<3 phase>

Affix label A that is included with the manuals near each wiring diagram for hydrobox and outdoor units.

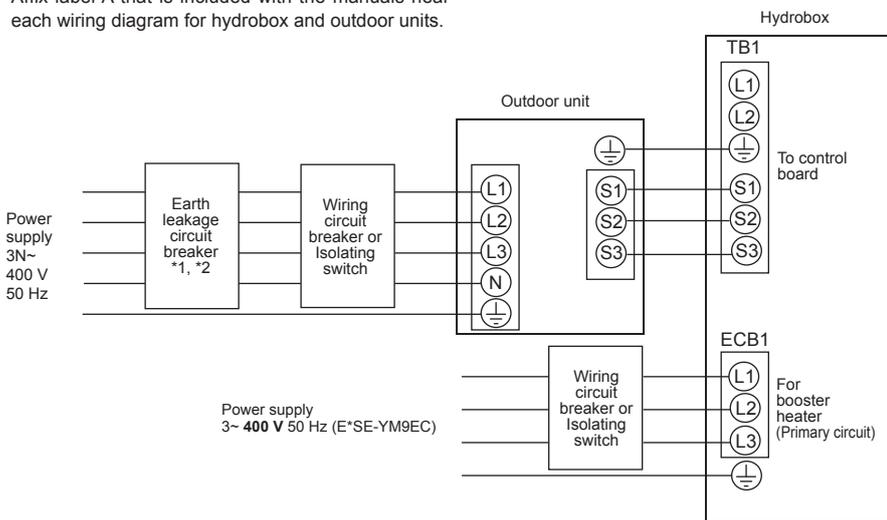

*1 If the installed earth leakage circuit breaker does not have an over-current protection function, install a breaker with that function along the same power line.

Description	Power supply	Capacity	Breaker	Wiring
Booster heater (Primary circuit)	3~ 400 V 50 Hz	9 kW	16 A *2	2.5 mm ²

<Figure 3.2.15>
Electrical connections 3 phase

Wiring No. × size (mm ²)	Hydrobox - Outdoor unit	*3	3 × 1.5 (polar)
	Hydrobox - Outdoor unit earth	*3	1 × Min. 1.5
Circuit rating	Hydrobox - Outdoor unit S1 - S2	*4	230 V AC
	Hydrobox - Outdoor unit S2 - S3	*4	24 V DC

*2. A breaker with at least 3.0 mm contact separation in each pole shall be provided. Use earth leakage breaker (NV). The breaker shall be provided to ensure disconnection of all active phase conductors of the supply.

*3. Max. 45 m

If 2.5 mm² used, Max. 50 m

If 2.5 mm² used and S3 separated, Max. 80 m

*4. The values given in the table above are not always measured against the ground value.

- Notes:**
1. Wiring size must comply with the applicable local and national codes.
 2. Indoor unit/outdoor unit connecting cords shall not be lighter than polychloroprene sheathed flexible cord. (Design 60245 IEC 57)
Indoor unit power supply cords shall not be lighter than polychloroprene sheathed flexible cord. (Design 60227 IEC 53)
 3. Install an earth longer than other cables.
 4. Please keep enough output capacity of power supply for each heater. Insufficient power supply capacity might cause chattering.

EHSE/ERSE series

Option2: Hydrobox powered by independent source

If the hydrobox and outdoor units have separate power supplies, the following requirements MUST be carried out:

- Change connector connections in hydrobox control and electrical box (see Figure 3.2.16).
 - Turn the outdoor unit DIP switch SW8-3 to ON.
 - Turn on the outdoor unit BEFORE the hydrobox.
 - Power by independent source is not available for particular models of outdoor unit model.
- For more detail, refer to the connecting outdoor unit installation manual.

<1 phase>

Affix label B that is included with the manuals near each wiring diagram for hydrobox and outdoor units.

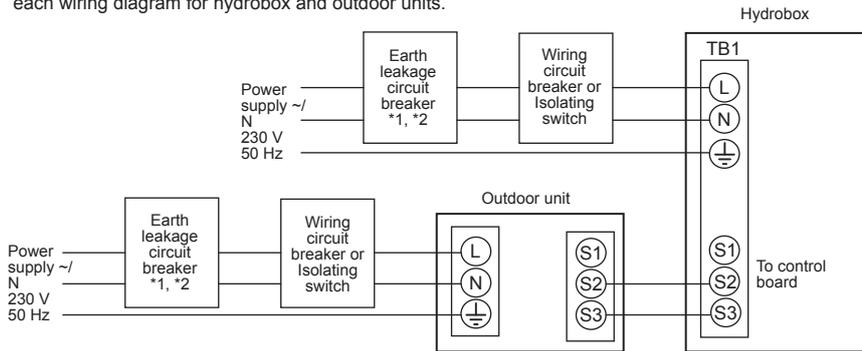

<Figure 3.2.17>
Electrical connections 1 phase

<3 phase>

Affix label B that is included with the manuals near each wiring diagram for hydrobox and outdoor units.

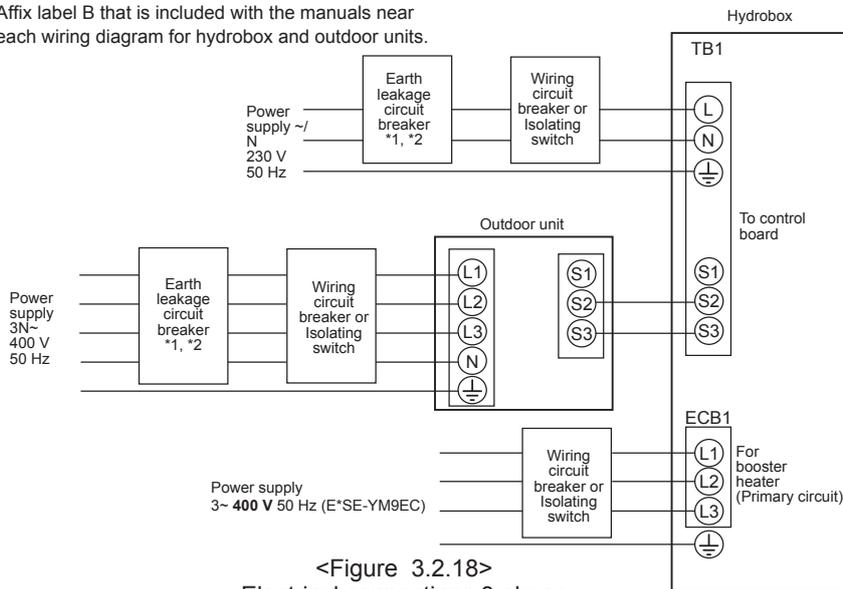

<Figure 3.2.18>
Electrical connections 3 phase

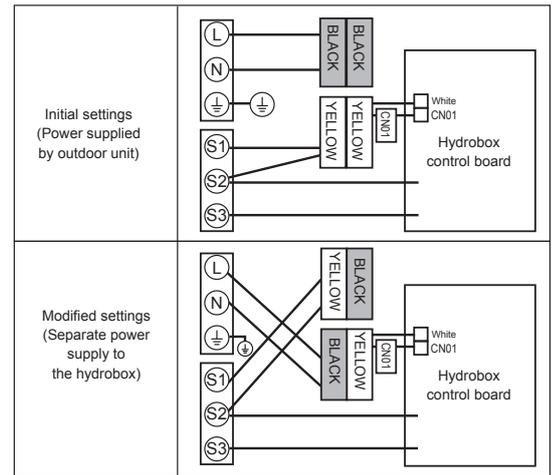

<Figure 3.2.16>

*1 If the installed earth leakage circuit breaker does not have an over-current protection function, install a breaker with that function along the same power line.

*1 If the installed earth leakage circuit breaker does not have an over-current protection function, install a breaker with that function along the same power line.

Description	Power supply	Capacity	Breaker	Wiring
Booster heater (Primary circuit)	3~ 400 V 50 Hz	9 kW	16 A *2	2.5 mm ²

Hydrobox power supply		~N 230 V 50 Hz
Hydrobox input capacity		~2 16 A
Wiring No. x size (mm ²)	Hydrobox power supply	2 x Min. 1.5
	Hydrobox power supply earth	1 x Min. 1.5
	Hydrobox - Outdoor unit	*3 2 x Min. 0.3
	Hydrobox - Outdoor unit earth	—
Circuit rating	Hydrobox L - N	*4 230 V AC
	Hydrobox - Outdoor unit S1 - S2	*4 —
	Hydrobox - Outdoor unit S2 - S3	*4 24 V DC

Notes: 1. Wiring size must comply with the applicable local and national codes.

2. Indoor unit/outdoor unit connecting cords shall not be lighter than polychloroprene sheathed flexible cord. (Design 60245 IEC 57)
Indoor unit power supply cords shall not be lighter than polychloroprene sheathed flexible cord. (Design 60227 IEC 53)

3. Install an earth longer than other cables.

4. Please keep enough output capacity of power supply for each heater. Insufficient power supply capacity might cause chattering.

*2. A breaker with at least 3.0 mm contact separation in each pole shall be provided. Use earth leakage breaker (NV). The breaker shall be provided to ensure disconnection of all active phase conductors of the supply.

*3. Max. 120 m

*4. The values given in the table above are not always measured against the ground value.

3.3 Using SD memory card

The hydrobox is equipped with an SD memory card interface in FTC. Using an SD memory card can simplify main remote controller settings and can store operating logs. *1

- (a) For insertion, push on the SD memory card until it clicks into place.
- (b) For ejection, push on the SD memory card until it clicks.

Note: To avoid cutting fingers, do not touch sharp edges of the SD memory card connector (CN108) on the FTC control board.

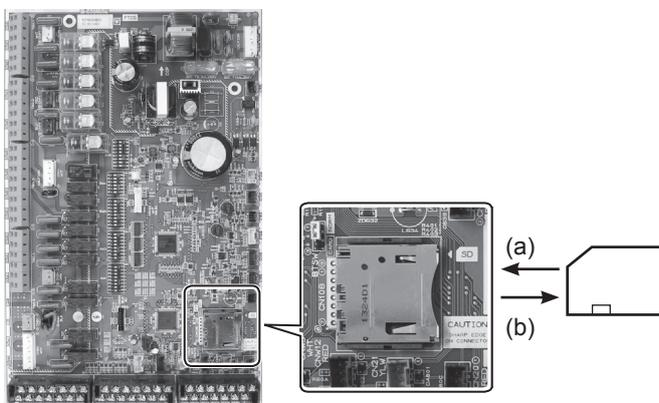

<Handling precautions>

- (1) Use an SD memory card that complies with the SD standards. Check that the SD memory card has a logo on it of those shown to the right.
- (2) SD memory cards to the SD standards include SD, SDHC, miniSD, micro SD, and microSDHC memory cards. The capacities are available up to 32 GB. Choose that with a maximum allowable temperature of 55°C.
- (3) When the SD memory card is a miniSD, miniSDHC, microSD, or micro SDHC memory card, use an SD memory card converter adapter.
- (4) Before writing to the SD memory card, release the write-protect switch.

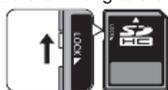

- (5) Before inserting or ejecting an SD memory card, make sure to power off the system. If an SD memory card is inserted or ejected with the system powered on, the stored data could be corrupted or the SD memory card be damaged. *An SD memory card is live for a short duration after the system is powered off. Before insertion or ejection wait until the LED lamps on the FTC control board are all off.
- (6) The read and write operations have been verified using the following SD memory cards, however, these operations are not always guaranteed as the specifications of these SD memory cards could change.

Manufacturer	Model	Tested in
Verbatim	#44015	Mar. 2012
SanDisk	SDSDB-002G-B35	Oct. 2011
Panasonic	RP-SDP04GE1K	Oct. 2011
Arvato	2GB PS8032 TSB 24nm MLC	Jun. 2012
Arvato	2GB PS8035 TSB A19nm MLC	Jul. 2014
SanDisk	SDSDUN-008G-G46	Oct. 2016
Verbatim	#43961	Oct. 2016
Verbatim	#44018	Oct. 2016

Before using a new SD memory card (including the card that comes with the unit), always check that the SD memory card can be safely read and written to by the FTC controller.

<How to check read and write operations>

- a) Check for correct wiring of power supply to the system. For more details, refer to section 3.1.4 or 3.2.5. (Do not power on the system at this point.)
- b) Insert an SD memory card.
- c) Power on the system.
- d) The LED4 lamp lights if the read and write operations are successfully completed. If the LED4 lamp continues blinking or does not light, the SD memory card cannot be read or written to by the FTC controller.
- (7) Make sure to follow the instruction and the requirement of the SD memory card's manufacturer.
- (8) Format the SD memory card if determined unreadable in step (6). This could make it readable. Download an SD card formatter from the following site. SD Association homepage: <https://www.sdcard.org/home/>
- (9) FTC supports FAT file system but not NTFS file system.
- (10) Mitsubishi Electric is not liable for any damages, in whole or in part, including failure of writing to an SD memory card, and corruption and loss of the saved data, or the like. Back up saved data as necessary.
- (11) Do not touch any electronic parts on the FTC control board when inserting or ejecting an SD memory card, or else the control board could fail.

Logos



Capacities

2 GB to 32 GB *2

SD speed classes

All

- * The SD Logo is a trademark of SD-3C, LLC.
- The miniSD logo is a trademark of SD-3C, LLC.
- The microSD logo is a trademark of SD-3C, LLC.

*1 To edit main remote controller settings or to check operating data, an Ecodan service tool (for use with PC) is required.

*2 A 2-GB SD memory card stores up to 30 days of operation logs.

3.4 Caution on connecting DHW tank (Hydrobox)

Note:

- Be aware that the respective DHW operations are greatly effected by the selections of the components such as tank, immersion heater, or the like.
- Follow your local regulations to perform system configuration.

1. To enable switching of the water circulation circuit between the DHW mode and the heating mode, install a 3-way valve (local supply). The 3-way valve and the DHW tank should be positioned as shown in the system diagram on the page B-53, Figure 4.5 or 4.6 as applicable.
The use of two 2-way valves can perform the same function as a 3-way valve.
2. Install the optional thermistor THW5 (optional part PAC-TH011TK-E/PAC-TH011TKL-E) on the DHW tank.
It is recommended to position the thermistor at the mid point of the DHW tank capacity. Insulate thermistor from ambient air. Especially for double (insulated) tank, thermistor should be attached to the inner side (to detect the water temperature).
3. Connect the thermistor lead to the CNW5 connector on the FTC.
If the thermistor lead is too long bundle it with a strap to adjust the length.
4. The output terminals for the 3-way valve is TBO.2 4-5 (OUT4).
The TBO.2 4-5 terminals on the FTC are shown in the wiring diagram on B-38.
Choose the terminals that the 3-way valve is connected to between TBO.2 4-5, or TBO.2 4-6, according to the rated voltage.
When the rated current of the 3-way valve exceeds 0.1A, be sure to use a relay with maximum voltage and current ratings of 230V AC / 0.1A when connecting to the FTC. Do not directly connect the 3-way valve cable to the FTC. Connect the relay cable to the TBO.2 4-5 terminals.
3-way valve must be of SPST type. SPDT type can NOT be used.
For systems using 2-way valves instead of a 3-way valve please read the following;

Specification of 2-way valve (local supply)

- Power supply: 230V AC
- Current: 0.1A Max (If over 0.1A you must use a relay)
- Type: Normally closed

	Installation position	Electrical connection terminal block	Output signal		
			Heating	DHW	System OFF
2-way valve1	DHW	TBO.2 4-5	OFF (closed)	ON (open)	OFF (closed)
2-way valve2	Heating	TBO.4 1-2	ON (open)	OFF (closed)	OFF (closed)

Note: Should the 2-way valve become blocked the water circulation will stop. A by-pass valve or circuit should be installed between pump and 2-way valve for safety.

The TBO.4 1-2 terminals on the FTC are shown in the wiring diagram. The 2-way valve (local supply) should be installed according to the instructions supplied with it. Follow 2-way valve's manufacturer's instructions as to whether to connect an earth cable or not.

- For the 2-way valve, choose the one that slowly opens and shuts off to prevent water hammer sound.
- Choose the 2-way valve equipped with manual override, which is necessary for topping up or draining of water.

5. Turn the DIP SW1-3 on the FTC to ON.

6. When using an immersion heater (local supply), connect a contact relay cable for the immersion heater to TBO.4 3-4 (OUT9), and turn the DIP SW1-4 to ON. Do NOT directly connect the power cable to the FTC.

Note:

- When an immersion heater is installed, select appropriate breaker capacity and a cable with appropriate diameter on the basis of heater output.
- When wiring an immersion heater in the field, always install an earth leakage breaker to prevent accidental electric shock.

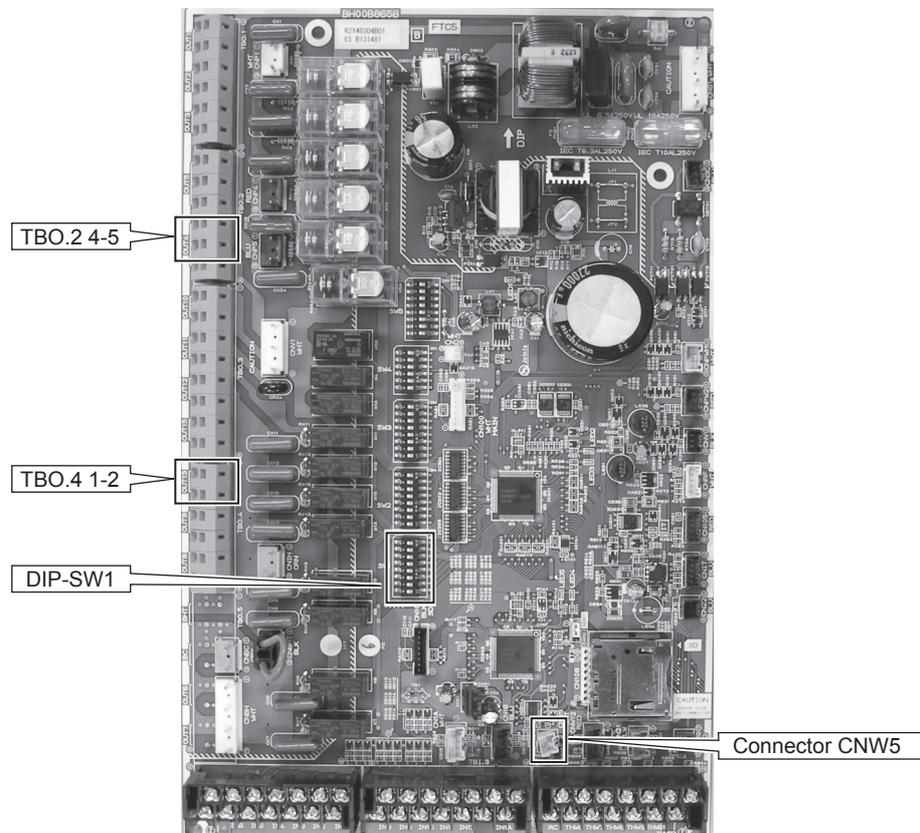

- ⚠ WARNING: When connecting DHW tank**
- (1) Attach the optional thermistor THW5 (PAC-TH011TK-E / PAC-TH011TKL-E).
 - (2) Always use earth leakage breaker when connecting immersion heater.
 - (3) When installing an immersion heater, be sure that the immersion heater has a built-in direct cut-off thermostat.
 - (4) Connect a pressure relief valve on the sanitary water side.
 - (5) It is essential that no check valve or isolating valve is fitted between the hydrobox and the pressure relief valve.

Recommended DHW system

Where system involves a DHW tank:

DHW tank	Immersion heater	Booster heater	BH function	System diagram	Thermistor
Present	Absent	Present	For space heating/ cooling and DHW		THW1: Flow water temp. THW2: Return water temp. THW5: Tank water temp. (optional part PAC-TH011TK-E / PAC-TH011TKL-E)
Present	Present	Present	For space heating/ cooling and DHW		THW1: Flow water temp. THW2: Return water temp. THW5: Tank water temp. (optional part PAC-TH011TK-E / PAC-TH011TKL-E)

*The use of two 2-way valves can perform same function as a 3-way valve.

3.5 Wiring for 2-zone temperature control

1. Water circulation pump 2 (Zone1 water circulation pump) / Water circulation pump 3 (Zone2 water circulation pump)
Electrically wire water circulation pumps 2 and 3 to the appropriate output terminals. (Refer to "Outputs" in 3.1.3 or 3.2.4.)
2. Flow switch 2 (Zone1 flow switch) / Flow switch 3 (Zone2 flow switch)
Connect flow switches 2 and 3 to the appropriate terminals. (Refer to "Signal inputs" in 3.1.3 or 3.2.4.)
Set DIP switches 3-2 and 3-3 according to the functions of individual flow switches 2 and 3.
(Refer to "DIP switch functions" in 3.1.2, 3.2.2. or 3.2.3)
3. Thermistor
Connect the thermistor to monitor the Zone1 flow temperature to the THW6 (TBI. 2-3 and 2-4) terminals.
Connect the thermistor to monitor the Zone1 return temperature to the THW7 (TBI. 2-5 and 2-6) terminals.
Connect the thermistor to monitor the Zone2 flow temperature to the THW8 (TBI. 2-7 and 2-8) terminals.
Connect the thermistor to monitor the Zone2 return temperature to the THW9 (TBI. 2-9 and 2-10) terminals.

The maximum length of the thermistor wiring is 30 m. The length of the optional thermistors are 5 m. If you need to splice and extend the wirings, following points must be carried out.

- 1) Connect the wirings by soldering.
- 2) Insulate each connecting point against dust and water.

4. Motorized mixing valve

Connect three wires coming from the motorized mixing valve to the appropriate terminals referring to "Outputs" in 3.1.3 or 3.2.4.

Note: Connect the signal line to open Port A (hot water inlet port) to TBO. 2-3 (Open), the signal line to open Port B (cold water inlet port) to TBO. 2-1 (Close), and the neutral terminal wire to TBO. 2-2 (N).

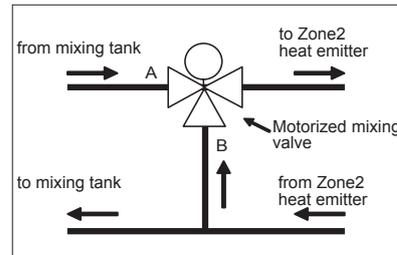
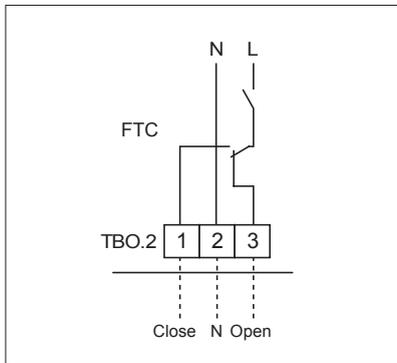

Cylinder unit

No.	Part name	E*ST20*-M2/6/9C	E*ST20*-M2/6/9EC	E*ST20*-MEC	EHST20D-MHC	EHPT20X*-M2/6/9C	EHPT20X-MHCW	EHST20*-MHCW
A	DHW outlet pipe	✓	✓	✓	✓	✓	✓	✓
B	Cold water inlet pipe	✓	✓	✓	✓	✓	✓	✓
C	Water pipe (Space heating/cooling return connection)	✓	✓	✓	✓	✓	✓	✓
D	Water pipe (Space heating/cooling flow connection)	✓	✓	✓	✓	✓	✓	✓
E	Water pipe (Flow from heat pump connection)	—	—	—	—	✓	✓	—
F	Water pipe (Return to heat pump connection)	—	—	—	—	✓	✓	—
G	Refrigerant pipe (Gas)	✓	✓	✓	✓	—	—	✓
H	Refrigerant pipe (Liquid)	✓	✓	✓	✓	—	—	✓
1	Control and electrical box	✓	✓	✓	✓	✓	✓	✓
2	Main remote controller	✓	✓	✓	✓	✓	✓	✓
3	Plate heat exchanger (Refrigerant - Water)	✓	✓	✓	✓	—	—	✓
4	Booster heater 1,2	✓	✓	—	—	✓	—	—
5	3-way valve	✓	✓	✓	✓	✓	✓	✓
6	Manual air vent	✓	✓	✓	✓	✓	✓	✓
7	Drain cock (Primary circuit)	✓	✓	✓	✓	✓	✓	✓
8	Manometer	✓	✓	✓	✓	✓	✓	✓
9	Pressure relief valve (3bar)	✓	✓	✓	✓	✓	✓	✓
10	Automatic air vent	✓	✓	✓	✓	✓	✓	✓
11	Expansion vessel	✓	—	—	✓	✓	✓	✓
12	Flow sensor	✓	✓	✓	✓	✓	✓	✓
13	Strainer valve	✓	✓	✓	✓	✓	✓	✓
14	Water circulation pump 1 (Primary circuit)	✓	✓	✓	✓	✓	✓	✓
15	Pump valve	✓	✓	✓	✓	✓	✓	✓
16	DHW tank	✓	✓	✓	✓	✓	✓	✓
17	Plate heat exchanger (Water - Water)	✓	✓	✓	✓	✓	✓	✓
18	Scale trap	✓	✓	✓	✓	✓	✓	✓
19	Water circulation pump (Sanitary circuit)	✓	✓	✓	✓	✓	✓	✓
20	Immersion heater	—	—	—	✓	—	✓	✓
21	Temperature and pressure relief valve	—	—	—	—	—	—	✓
22	Pressure relief valve (10bar) (DHW Tank)	✓	✓	—	✓	—	—	—
23	Drain cock (DHW tank)	✓	✓	✓	✓	✓	✓	✓
24	Drain cock (Sanitary circuit)	✓	✓	✓	✓	✓	✓	✓
25	Flow water temp. thermistor (THW1)	✓	✓	✓	✓	✓	✓	✓
26	Return water temp. thermistor (THW2)	✓	✓	✓	✓	✓	✓	✓
27	DHW tank water temp. thermistor (THW5)	✓	✓	✓	✓	✓	✓	✓
28	Refrigerant liquid temp. thermistor (TH2)	✓	✓	✓	✓	—	—	✓
29	Outdoor unit	—	—	—	—	—	—	—
30	Drain pipe (Local supply)	—	—	—	—	—	—	—
31	Back flow prevention device (Local supply)	—	—	—	—	—	—	—
32	Isolating valve (Local supply)	—	—	—	—	—	—	—
33	Magnetic filter (Local supply) (Recommended)	—	—	—	—	—	—	—
34	Strainer (Local supply)	—	—	—	—	—	—	—
35	Inlet control group *1	—	—	—	—	—	—	—
36	Filling loop (Ball valves, check valves and flexible hose) *1	—	—	—	—	—	—	—
37	Potable expansion vessel *1	—	—	—	—	—	—	—

*1 Supplied with UK model ONLY. Please refer to PAC-WK01UK-E Installation Manual for more information on accessories.

<Note> For installation of E*ST20*-M*EC model, make sure to install a primary-side expansion vessel in the field. (See figure 4.2.3)

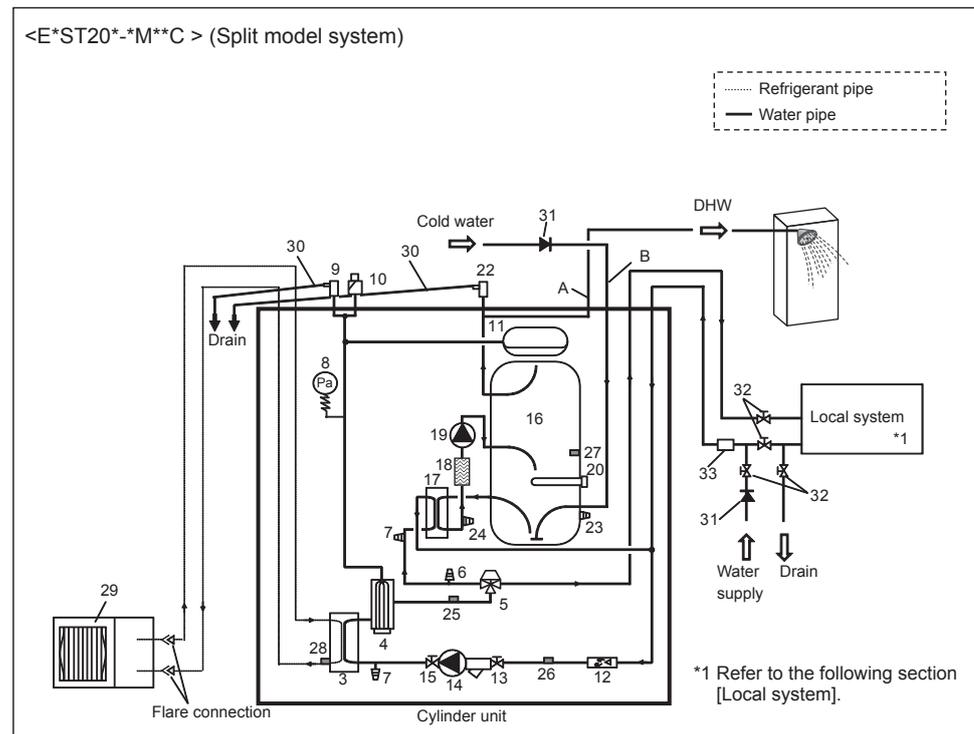

Note

- To enable draining of the cylinder unit an isolating valve should be positioned on both the inlet and outlet pipework.
- Be sure to install a strainer on the inlet pipework to the cylinder unit.
- Suitable drain pipework should be attached to all relief valves in accordance with your country's regulations.
- A backflow prevention device must be installed on the cold water supply pipework (IEC 61770)
- When using components made from different metals or connecting pipes made of different metals insulate the joints to prevent any corrosive reaction taking place which may damage the pipework.

<Figure 4.1>

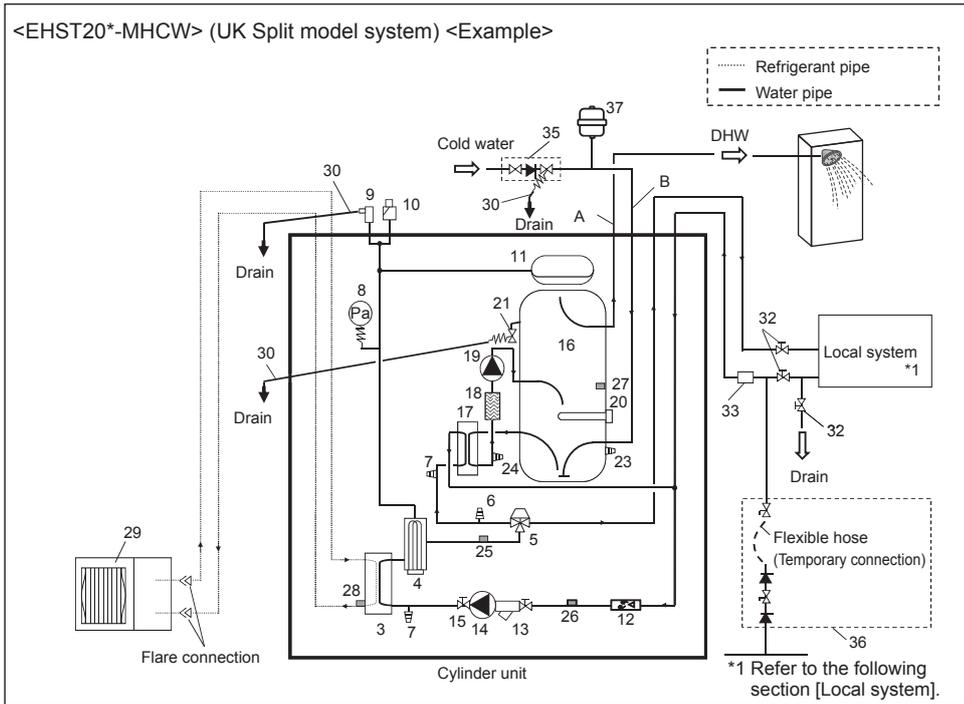

Note

- To enable draining of the cylinder unit an isolating valve should be positioned on both the inlet and outlet pipework. No valve should be fitted between the expansion valve (item 35) and the cylinder unit (safety matter).
- Be sure to install a strainer on the inlet pipework to the cylinder unit.
- Suitable drain pipework should be attached to all relief valves in accordance with your country's regulations.
- When using components made from different metals or connecting pipes made of different metals insulate the joints to prevent any corrosive reaction taking place which may damage any pipework.
- Filling loop's flexible hose must be removed following the filling procedure. Item provided with unit as loose accessory.
- Install the inlet control group (item 35) above the level of the T&P relief valve (item 21). This will ensure DHW tank will not require drain-down to service/maintain the inlet control group.

<Figure 4.2>

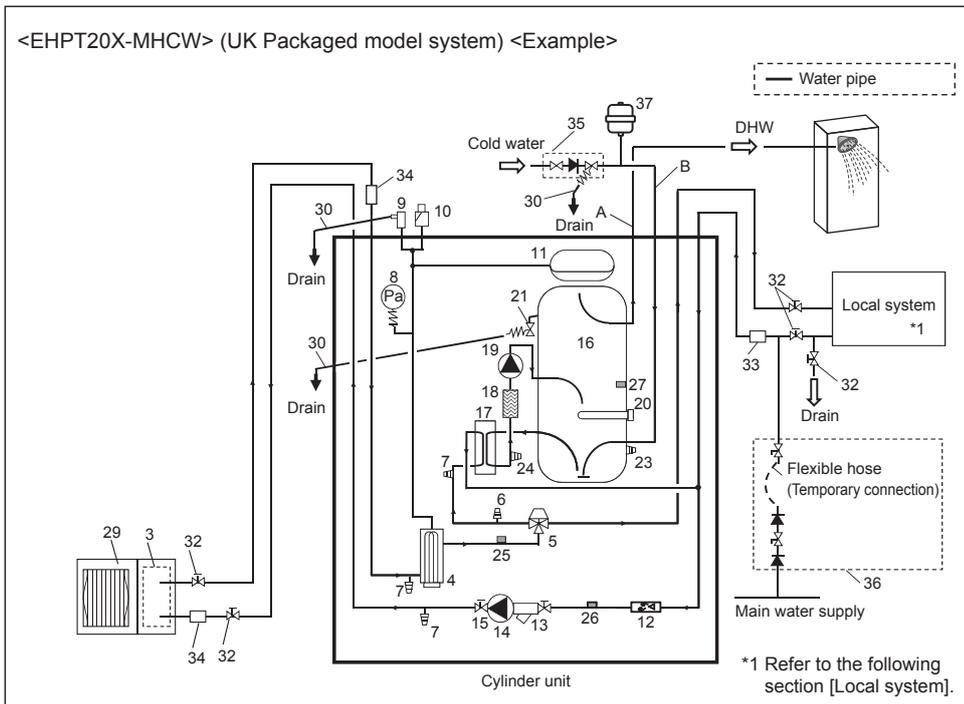

Note

- To enable draining of the cylinder unit an isolating valve should be positioned on both the inlet and outlet pipework. No valve should be fitted between the expansion valve (item 35) and the cylinder unit (safety matter).
- Be sure to install a strainer on the inlet pipework to the cylinder unit.
- Suitable drain pipework should be attached to all relief valves in accordance with your country's regulations.
- When using components made from different metals or connecting pipes made of different metals insulate the joints to prevent any corrosive reaction taking place which may damage any pipework.
- Filling loop's flexible hose must be removed following the filling procedure. Item provided with unit as loose accessory.
- Install the inlet control group (item 35) above the level of the T&P relief valve (item 21). This will ensure DHW tank will not require drain-down to service/maintain the inlet control group.

<Figure 4.3>

Model name	EHPT20X-MHCW	EHST20C-MHCW	EHST20D-MHCW
Maximum supply pressure to the pressure reducing valve	16 bar	16 bar	16 bar
Operating pressure (Potable side)	3.5 bar	3.5 bar	3.5 bar
Expansion vessel charge setting pressure (Potable side)	3.5 bar	3.5 bar	3.5 bar
Expansion valve setting pressure (Potable side)	6.0 bar	6.0 bar	6.0 bar
Immersion heater specification (Potable side) *	3000 W, 230 V	3000 W, 230 V	3000 W, 230 V
DHW tank capacity	200 L	200 L	200 L
Mass of the unit when full	307 kg	320 kg	312 kg
Maximum primary working pressure	2.5 bar	2.5 bar	2.5 bar

* EN60335/Type 3000W single phase 230V 50Hz, length 460 mm.
Use only Mitsubishi Electric service parts as a direct replacement.

<Table 4.1>

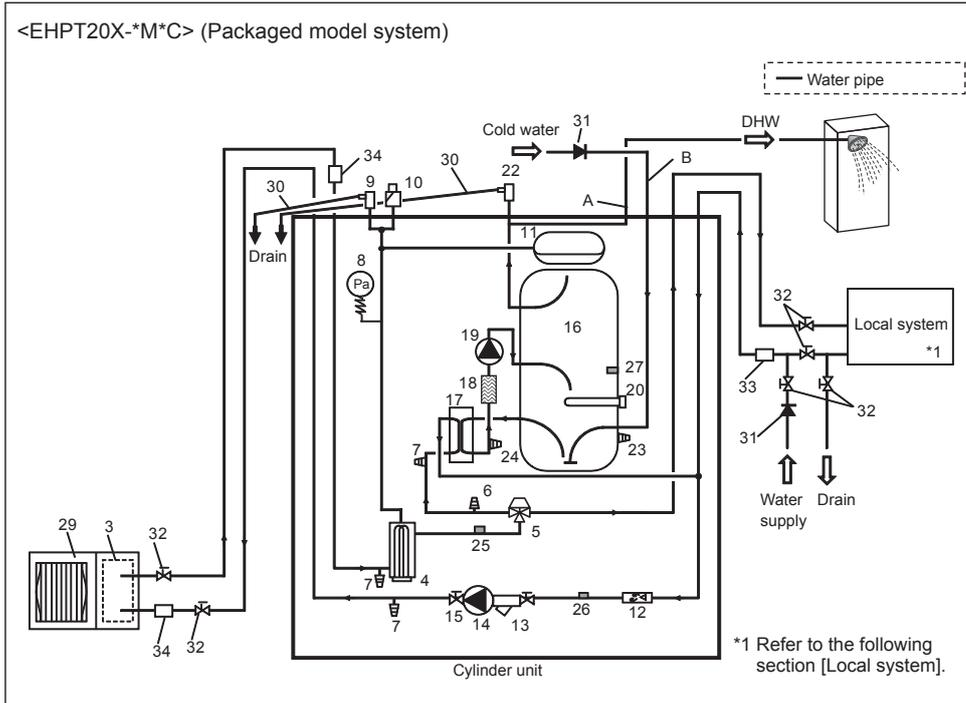

Note

- To enable draining of the cylinder unit an isolating valve should be positioned on both the inlet and outlet pipework.
- Be sure to install a strainer on the inlet pipework to the cylinder unit.
- Suitable drain pipework should be attached to all relief valves in accordance with your country's regulations.
- A backflow prevention device must be installed on the cold water supply pipework (IEC 61770)
- When using components made from different metals or connecting pipes made of different metals insulate the joints to prevent any corrosive reaction taking place which may damage the pipework.)

<Figure 4.4>

Hydrobox (Except for EHSE/ERSE series)

No.	Part name	EHS*-MEC	EHSD-MC	EHS*-M°C	EHSC-*M°EC	ERS*-VM2C	ERSC-MEC	EHPX-*M°C
1	Control and electrical box	✓	✓	✓	✓	✓	✓	✓
2	Main remote controller	✓	✓	✓	✓	✓	✓	✓
3	Plate heat exchanger (Refrigerant - Water)	✓	✓	✓	✓	✓	✓	-
4	Water circulation pump 1	✓	✓	✓	✓	✓	✓	✓
5	Pump valve	✓	✓	✓	✓	✓	✓	✓
6	Drain cock (Primary circuit)	✓	✓	✓	✓	✓	✓	✓
7	Booster heater 1, 2	-	-	✓	✓	✓	-	✓
8	Flow sensor	✓	✓	✓	✓	✓	✓	✓
9	Manometer	✓	✓	✓	✓	✓	✓	✓
10	Pressure relief valve (3 bar)	✓	✓	✓	✓	✓	✓	✓
11	Automatic air vent	✓	✓	✓	✓	✓	✓	✓
12	Expansion vessel	-	✓	✓	-	✓	-	✓
13	Strainer valve	✓	✓	✓	✓	✓	✓	✓
14	Drain pan	-	-	-	-	✓	✓	-
15	THW1	✓	✓	✓	✓	✓	✓	✓
16	THW2	✓	✓	✓	✓	✓	✓	✓
17	TH2	✓	✓	✓	✓	✓	✓	-
18	THW5 (Optional part PAC-TH011TK-E or PAC-TH011TKL-E)	-	-	-	-	-	-	-
19	Outdoor unit	-	-	-	-	-	-	-
20	Drain pipe (Local supply)	-	-	-	-	-	-	-
21	3-way valve (Local supply)	-	-	-	-	-	-	-
22	DHW indirect unvented tank (Local supply)	-	-	-	-	-	-	-
23	Cold water inlet pipe (Local supply)	-	-	-	-	-	-	-
24	DHW outlet pipe (Local supply)	-	-	-	-	-	-	-
25	Back flow prevention device (Local supply)	-	-	-	-	-	-	-
26	Isolating valve (Local supply)	-	-	-	-	-	-	-
27	Magnetic filter (Local supply) (Recommended)	-	-	-	-	-	-	-
28	Strainer (Local supply)	-	-	-	-	-	-	-

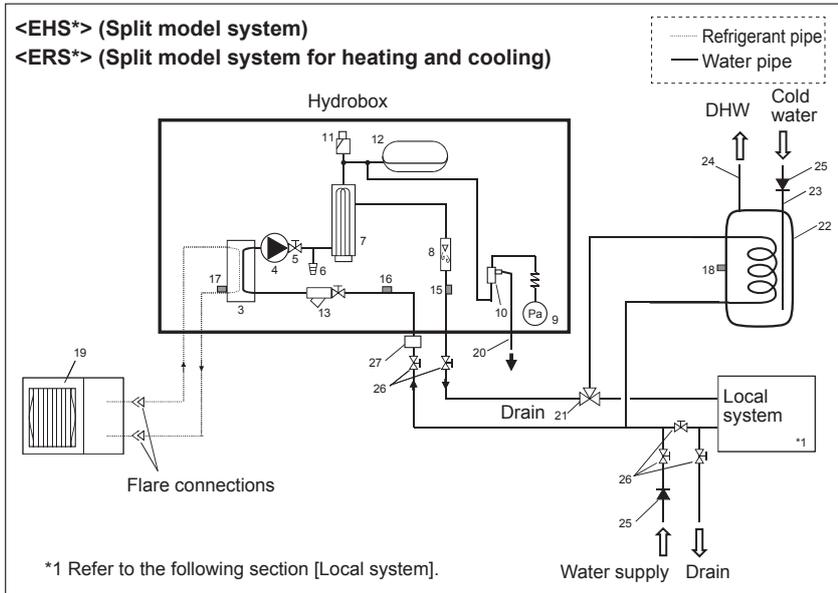

<Figure 4.5>

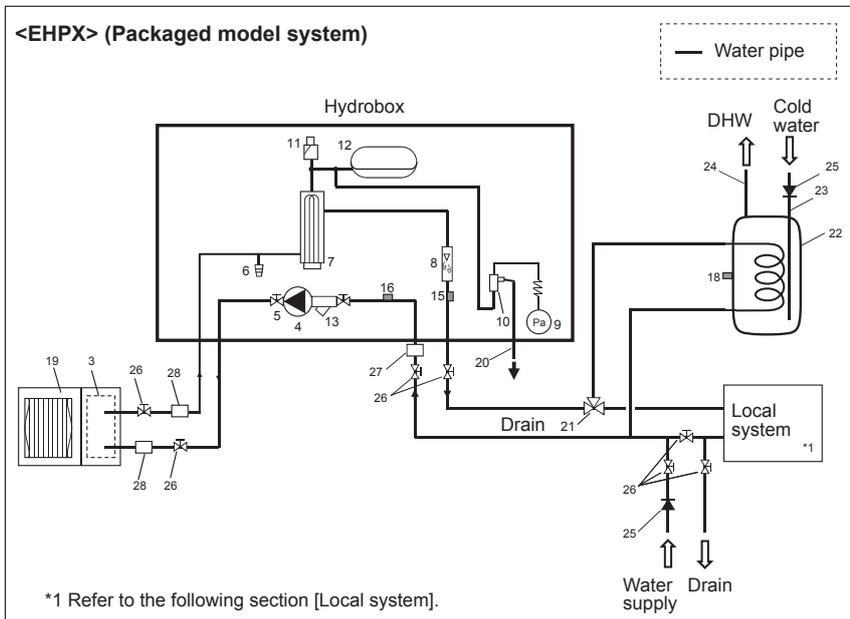

<Figure 4.6>

Note

- Be sure to follow your local regulations to perform system configuration of the DHW connections.
- DHW connections are not included in the hydrobox package. All required parts are to be sourced locally.
- To enable draining of the hydrobox an isolating valve should be positioned on both the inlet and outlet pipework.
- Be sure to install a strainer on the inlet pipe work to the hydrobox.
- Suitable drain pipework should be attached to all relief valves in accordance with your country's regulations.
- A backflow prevention device must be installed on water supply pipework (IEC 61770).
- When using components made of different metals or connecting pipes made of different metals insulate the joints to prevent a corrosive reaction taking place which will damage the pipework.

Hydrobox (EHSE/ERSE series)

No.	Part name	EHSE-YM9EC	EHSE-MEC	ERSE-YM9EC	ERSE-MEC
1	Control and electrical box	✓	✓	✓	✓
2	Main remote controller	✓	✓	✓	✓
3	Plate heat exchanger (Refrigerant - Water)	✓	✓	✓	✓
4	Water circulation pump	✓	✓	✓	✓
5	Pump valve	✓	✓	✓	✓
6	Drain cock (Primary circuit)	✓	✓	✓	✓
7	Booster heater 1, 2	✓	—	✓	—
8	Flow sensor	✓	✓	✓	✓
9	Manometer	✓	✓	✓	✓
10	Pressure relief valve (3 bar)	✓	✓	✓	✓
11	Automatic air vent	✓	✓	✓	✓
12	Strainer valve	✓	✓	✓	✓
13	Drain pan	—	—	✓	✓
14	THW1	✓	✓	✓	✓
15	THW2	✓	✓	✓	✓
16	TH2	✓	✓	✓	✓
17	THW5 (Optional part PAC-TH011TK-E or PAC-TH011TKL-E)	—	—	—	—
18	Outdoor unit	—	—	—	—
19	Drain pipe (Local supply)	—	—	—	—
20	3-way valve (Local supply)	—	—	—	—
21	DHW indirect unvented tank (Local supply)	—	—	—	—
22	Cold water inlet pipe (Local supply)	—	—	—	—
23	DHW outlet pipe (Local supply)	—	—	—	—
24	Back flow prevention device (Local supply)	—	—	—	—
25	Isolating valve (Local supply)	—	—	—	—
26	Magnetic filter (Local supply) (Recommended)	—	—	—	—
27	Strainer (Local supply)	—	—	—	—

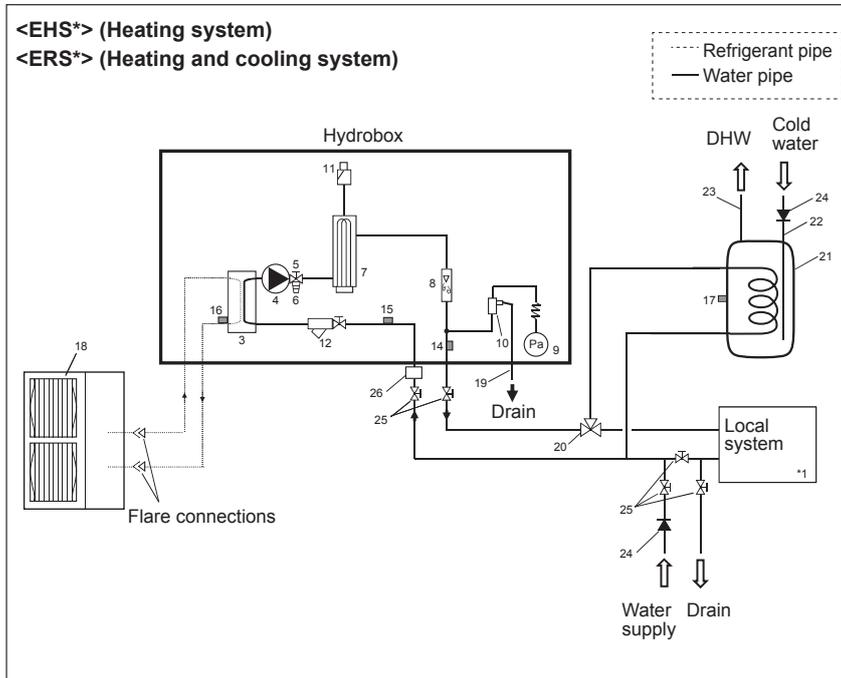

<Figure 4.7>

Note

- Be sure to follow your local regulations to perform system configuration of the DHW connections.
- DHW connections are not included in the hydrobox package. All required parts are to be sourced locally.
- To enable draining of the hydrobox an isolating valve should be positioned on both the inlet and outlet pipework.
- Be sure to install a strainer on the inlet pipe work to the hydrobox.
- Suitable drain pipework should be attached to all relief valves in accordance with your country's regulations.
- A backflow prevention device must be installed on water supply pipework (IEC 61770).
- When using components made from different metals or connecting pipes made of different metals insulate the joints to prevent a corrosive reaction taking place which will damage the pipework.

Local system

1-zone temperature control

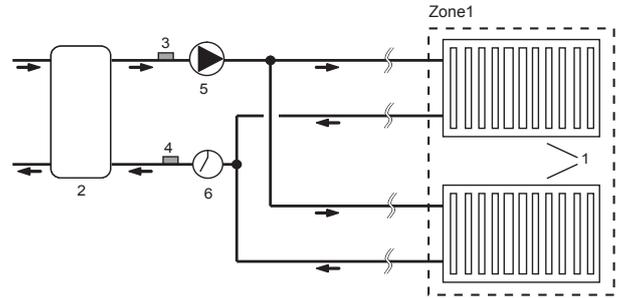
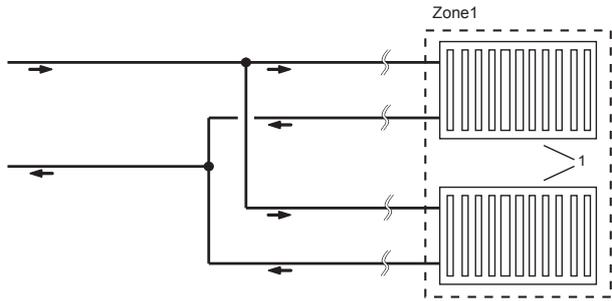

2-zone temperature control

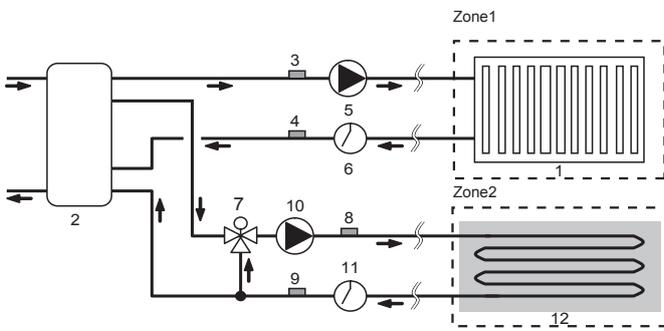

1-zone temperature control with boiler

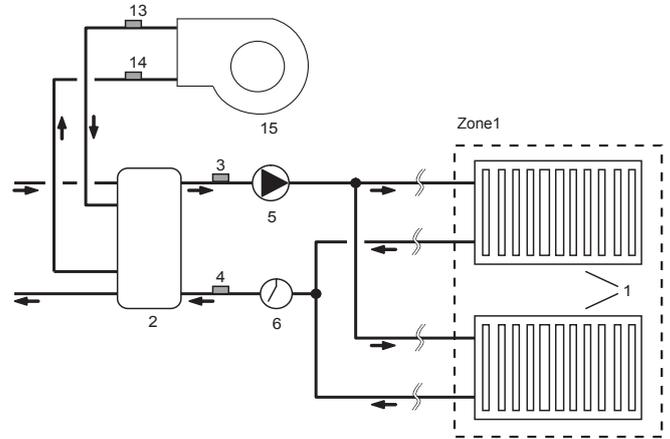

2-zone temperature control with boiler

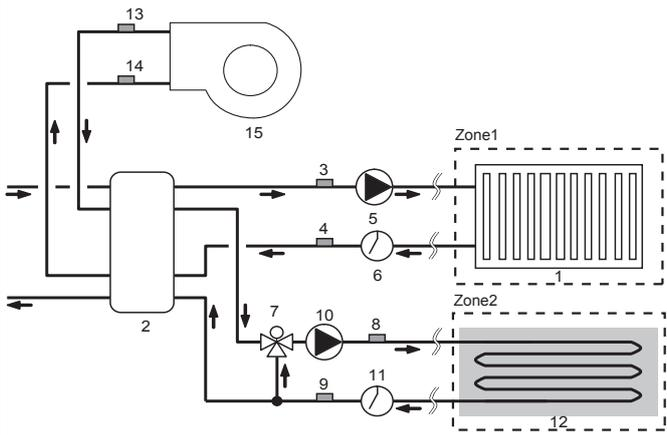

1-zone temperature control (2-zone valve ON/OFF control)

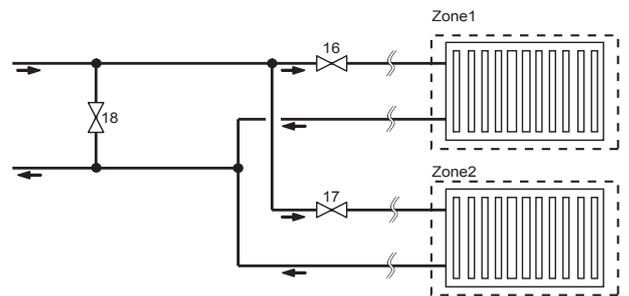

- 1. Zone1 heat emitters (e.g. radiator, fan coil unit) (local supply)
- 2. Mixing tank (local supply)
- 3. Zone1 flow water temp. thermistor (THW6)
- 4. Zone1 return water temp. thermistor (THW7) } Optional part : PAC-TH011-E
- 5. Zone1 water circulation pump (local supply)
- 6. Zone1 flow switch (local supply) *
- 7. Motorized mixing valve (local supply)
- 8. Zone2 flow water temp. thermistor (THW8)
- 9. Zone2 return water temp. thermistor (THW9) } Optional part : PAC-TH011-E

- 10. Zone2 water circulation pump (local supply)
- 11. Zone2 flow switch (local supply) *
- 12. Zone2 heat emitters (e.g. underfloor heating) (local supply)
- 13. Boiler flow water temp. thermistor (THWB1) } Optional part :
- 14. Boiler return water temp. thermistor (THWB2) } PAC-TH011HT-E
- 15. Boiler (local supply)
- 16. Zone1 2-way valve (local supply)
- 17. Zone2 2-way valve (local supply)
- 18. Bypass valve (local supply)

* Flow switch specifications: 12 V DC / 1 mA / Both normally-open and normally-closed types can be used. (Set DIP switch 3 to select the logics. Refer to "3.1.2 DIP switch setting (cylinder)" or "3.2.2/3.2.3 DIP switch setting (hydrobox)".)

4.1 Water Quality and System Preparation

■ General

- The water in both primary and sanitary circuit should be clean and with pH value of 6.5-8.0
- The followings are the maximum values;
 - Calcium: 100mg/L, Ca hardness: 250mg/L
 - Chlorine: 100mg/L, Copper: 0.3mg/L
- Other constituents should be to European Directive 98/83 EC standards.
- In known hard water areas, to prevent/minimise scaling, it is beneficial to restrict the routine stored water temperature (DHW max. temp.) to 55°C.

■ Anti-Freeze

Anti-freeze solutions should use propylene glycol with a toxicity rating of Class 1 as listed in Clinical Toxicology of Commercial Products, 5th Edition.

Note:

1. Ethylene glycol is toxic and should NOT be used in the primary water circuit in case of any cross-contamination of the potable circuit.
2. For 2-zone valve ON/OFF control, propylene glycol should be used.

■ New Installation (primary water circuit)

- Before connecting outdoor unit, thoroughly cleanse pipework of building debris, solder etc using a suitable chemical cleansing agent.
- Flush the system to remove chemical cleanser.
- For all packaged model systems add a combined inhibitor and anti-freeze solution to prevent damage to the pipework and system components.
- For split model systems the responsible installer should decide if anti-freeze solution is necessary for each site's conditions. Corrosion inhibitor however should always be used.

■ Existing Installation (primary water circuit)

- Before connecting outdoor unit the existing heating circuit MUST be chemically cleansed to remove existing debris from the heating circuit.
- Flush the system to remove chemical cleanser.
- For all packaged model systems, and the split model without booster heater, add a combined inhibitor and anti-freeze solution to prevent damage to the pipework and system components.
- For split model systems the responsible installer should decide if anti-freeze solution is necessary for each site's conditions. Corrosion inhibitor however should always be used.

When using chemical cleansers and inhibitors always follow manufacturer's instructions and ensure the product is appropriate for the materials used in the water circuit

4.2 Water Pipe Work

Note: Prevent the field piping from straining the piping on the cylinder unit/ hydrobox by fixing it to a wall or applying other methods.

■ Hot Water Pipework

The function of the following safety components of the cylinder unit/hydrobox should be checked on installation for any abnormalities;

- Pressure relief valve
- Expansion vessel pre-charge (gas charge pressure)

The instruction on the following pages regarding safe discharge of hot water from Safety devices should be followed carefully.

- The pipework will become very hot, so should be insulated to prevent burns.
- When connecting pipework, ensure that no foreign objects such as debris or the like do not enter the pipe.

■ Hydraulic Filter Work (ONLY EHPX series)

Install a hydraulic filter or strainer (local supply) at the water intake ("Pipe E" in Table 2.1.1)

■ Negative pressure prevention (ONLY CYLINDER unit)

To prevent negative pressure effecting DHW tank, installer should install appropriate pipework or use appropriate devices.

■ Pipework Connections (Except for EHSE/ERSE series)

Connections to the cylinder unit / hydrobox should be made using the 22 mm or 28 mm compression as appropriate. (except for ERSC series)

Do not over-tighten compression fittings as this will lead to deformation of the olive ring and potential leaks.

Note: To weld the pipes in the field, cool the pipes on the cylinder unit / hydrobox using wet towel etc.

ERSC series have G1 (male) thread connections.

■ Minimum amount of water required in the space heating / cooling circuit

Outdoor heat pump unit		Minimum water quantity [L]
Packaged model	PUHZ-W50	29
	PUHZ-W85	37
	PUHZ-W112	48
	PUHZ-HW112	48
	PUHZ-HW140	60
Split model	SUHZ-SW45	17
	PUHZ-SW50	22
	PUHZ-FRP71	32
	PUHZ-SW75	32
	PUHZ-SW100	43
	PUHZ-SW120	54
	PUHZ-SW160	69
	PUHZ-SW200	86
	PUHZ-SHW80	34
	PUHZ-SHW112	48
	PUHZ-SHW140	60
	PUHZ-SHW230	99
	PUMY-P112	80
	PUMY-P125	80
	PUMY-P140	80

Note:

For 2-zone temperature control system, the value in the table above excludes the amount of stored water in zone 2.

■ Pipework Connections (EHSE/ERSE series)

Connections to the hydrobox should be made using the G1-1/2 nut as appropriate. (The hydrobox has G1-1/2 (male) thread connections.) Please apply a gasket not to leak water.

Use two wrenches to tighten piping connection (see <Figure 4.2.1>).

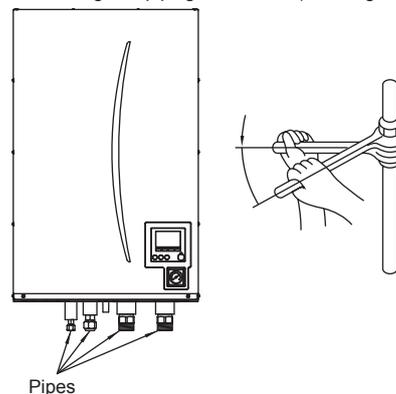

<Figure 4.2.1>

■ Insulation of Pipework

- All exposed water pipework should be insulated to prevent unnecessary heat loss and condensation. To prevent condensate entering the hydrobox, the pipework and connections at the top of the cylinder unit / hydrobox should be carefully insulated.
- Cold and hot water pipework should not be run close together where possible, to avoid unwanted heat transfer.
- Pipework between outdoor heat pump unit and cylinder unit / hydrobox should be insulated with suitable pipe insulation material with a thermal conductivity of ≤ 0.04 W/m.K.

■ Filling the System (Primary Circuit)

1. Check and charge expansion vessel.
2. Check all connections including factory fitted ones are tight.
3. Insulate pipework between cylinder unit/hydrobox and outdoor unit.
4. Thoroughly clean and flush, system of all debris. (see section 4.1 for instruction.)
5. Fill cylinder unit/hydrobox with potable water. Fill primary heating circuit with water and suitable anti-freeze and inhibitor as necessary. **Always use a filling loop with double check valve when filling the primary circuit to avoid back flow contamination of water supply.**

- Anti-freeze should always be used for packaged model systems (see section 4.1 for instruction). It is the responsibility of the installer to decide if anti-freeze solution should be used in split model systems depending on each site's conditions. Corrosion inhibitor should be used in both split model and packaged model systems. Figure 4.2.2 shows freezing temperature against anti-freeze concentration. This figure is an example for FERNOX ALPHI-11. For other anti-freeze, please refer to relevant manual.
- When connecting metal pipes of different materials insulate the joints to prevent a corrosive reaction taking place which will damage the pipework.

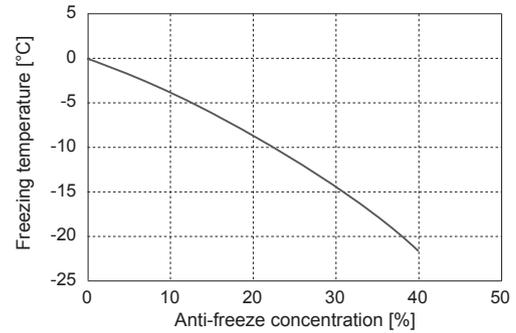

<Figure 4.2.2>

6. Check for leakages. If leakage is found, retighten the nut onto the connections.
7. Pressurise system to 1 bar.
8. Release all trapped air using air vents during and following heating period.
9. Top up with water as necessary. (If pressure is below 1 bar)

■ Sizing Expansion Vessels

Expansion vessel volume must fit the local system water volume. To size an expansion vessel both for the heating and cooling circuits the following formula and graph can be used.

<Except for EHSE/ERSE series>

When the necessary expansion vessel volume exceeds the volume of an built-in expansion vessel, install an additional expansion vessel so that the sum of the volumes of the expansion vessels exceeds the necessary expansion vessel volume.

- For installation of an E*S*-M*EC model, provide and install an expansion vessel in the field as the model does not come fitted with an expansion vessel.

$$V = \frac{\epsilon \times G}{1 - \frac{P_1 + 0.098}{P_2 + 0.098}}$$

Where;

- V : Necessary expansion vessel volume [L]
- ϵ : Water expansion coefficient
- G : Total volume of water in the system [L]
- P₁ : Expansion vessel setting pressure [MPa]
- P₂ : Max pressure during operation [MPa]

Graph to the right is for the following values

ϵ : at 70 °C = 0.0229

P₁ : 0.1 MPa

P₂ : 0.3 MPa

Note: 30% safety margin has been added.

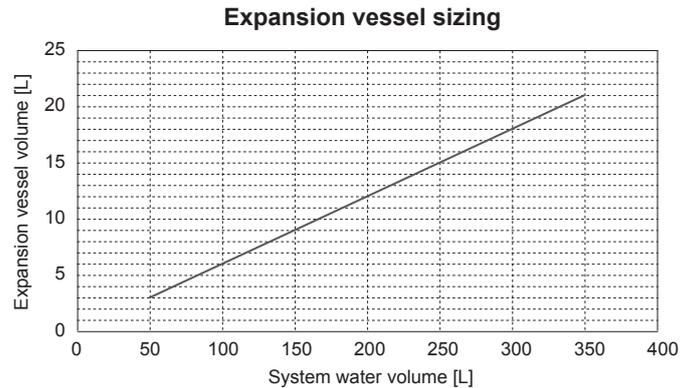

<Figure 4.2.3>

Water Circulation Pump Characteristics (Except for EHSE/ERSE series)

1. Primary circuit

Pump speed can be selected by main remote controller setting (see Section 4.3). Adjust the pump speed setting so that the flow rate in the primary circuit is appropriate for the outdoor unit installed (see Table 4.2.1). It may be necessary to add an additional pump to the system depending on the length and lift of the primary circuit. For outdoor unit model not listed in the <Table 4.2.1>, refer to Water flow rate range in the specification table of outdoor unit Data Book. In such case, make sure that the flow rate is greater than 7.1 L/min and less than 27.7 L/min.

<Second pump >

If a second pump is required for the installation please read the following carefully. If a second pump is used in the system it can be positioned in 2 ways. The position of the pump influences which terminal of the FTC the signal cable should be wired to. If the additional pump(s) have current greater than 1A please use appropriate relay. Pump signal cable can either be wired to TBO.1 1-2 or CNP1 but not both.

Option 1 (Space heating/cooling only)

If the second pump is being used for the heating circuit only then the signal cable should be wired to TBO.1 terminals 3 and 4 (OUT2). In this position the pump can be run at a different speed to the hydrobox's in-built pump.

Option 2 (Primary circuit DHW and space heating/cooling)

If the second pump is being used in the primary circuit between the hydrobox and the outdoor unit (Package system ONLY) then the signal cable should be wired to TBO.1 terminals 1 and 2 (OUT1). In this position the pump speed **MUST** match the speed of the hydrobox's in-built pump.

Note: Refer to 3.1.3 (cylinder) or 3.2.4 (hydrobox) Connecting inputs/outputs.

	Outdoor heat pump unit	Water flow rate range [L/min]
Packaged model	PUHZ-W50	6.5 - 14.3
	PUHZ-W85	10.8 - 25.8
	PUHZ-W112	14.4 - 27.7
	PUHZ-HW112	14.4 - 27.7
	PUHZ-HW140	17.9 - 27.7
Split model	SUHZ-SW45	7.1 - 12.9
	PUHZ-SW50	6.5 - 17.2
	PUHZ-FRP71	11.5 - 22.9
	PUHZ-SW75	9.5 - 22.9
	PUHZ-SW100	13.0 - 27.7
	PUHZ-SW120	17.9 - 27.7
	PUHZ-SHW80	10.2 - 22.9
	PUHZ-SHW112	14.4 - 27.7
	PUHZ-SHW140	17.9 - 27.7
	PUMY-P112	17.9 - 27.7
	PUMY-P125	17.9 - 27.7
	PUMY-P140	17.9 - 27.7

<Table 4.2.1>

* If the water flow rate is less than 7.1 L/min, the flow rate error will be activated.

If the water flow rate exceeds 27.7 L/min, the flow speed will be greater than 1.5 m/s, which could erode the pipes.

2. Sanitary circuit

Default setting: Speed 2

DHW circulation pump **MUST** be set to speed 2.

Water Circulation Pump Characteristics (EHSE/ERSE series)

Pump speed can be selected by main remote controller setting (see Section 4.3). Adjust the pump speed setting so that the flow rate in the primary circuit is appropriate for the outdoor unit installed (see Table 4.2.2). It may be necessary to add an additional pump to the system depending on the length and lift of the primary circuit.

<Second pump>

If a second pump is required for the installation please read the following carefully.

If a second pump is used in the system it can be positioned in 2 ways.

The position of the pump influences which terminal of the FTC the signal cable should be wired to. If the additional pump(s) have current greater than 1A please use appropriate relay. Pump signal cable can either be wired to TBO.1 1-2 or CNP1 but not both.

Option 1 (Space heating/cooling only)

If the second pump is being used for the heating circuit only then the signal cable should be wired to TBO.1 terminals 3 and 4 (OUT2). In this position the pump can be run at a different speed to the hydrobox's in-built pump.

Option 2 (Primary circuit DHW and space heating/cooling)

If the second pump is being used in the primary circuit between the hydrobox and the outdoor unit (Package system ONLY) then the signal cable should be wired to TBO.1 terminals 1 and 2 (OUT1). In this position the pump speed **MUST** match the speed of the hydrobox's in-built pump.

Note: Refer to 3.2.4 (hydrobox) Connecting inputs/outputs.

Outdoor heat pump unit	Water flow rate range [L/min]
PUHZ-SW160	23.0 - 61.5
PUHZ-SW200	28.7 - 61.5
PUHZ-SHW230	28.7 - 61.5

<Table 4.2.2>

* If the water flow rate is less than 7.1 L/min, the flow rate error will be activated.

* If the water flow rate exceeds 61.5 L/min, the flow speed will be greater than 1.5 m/s, which could erode the pipes.

4.3 Performance curve external pressure

■ Cylinder unit

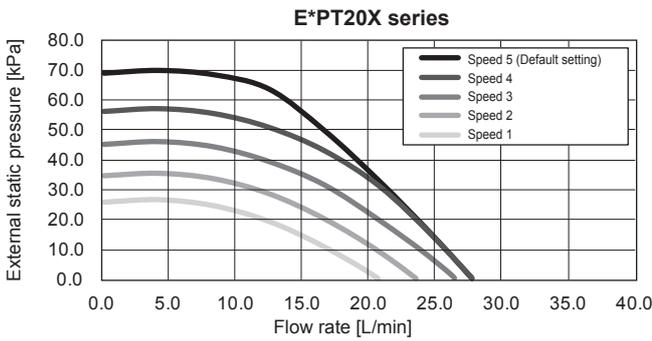
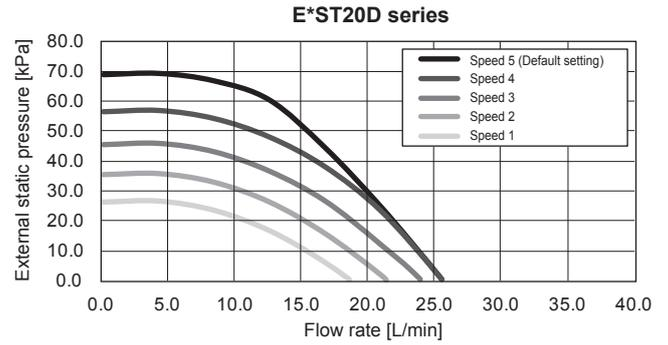
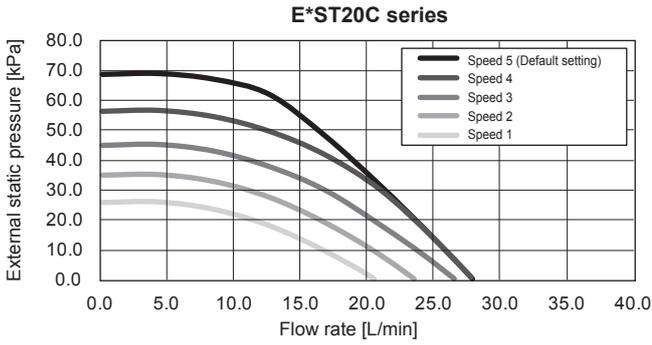

*For installation of EHPT20 series, set its pump speed with a pressure drop between the cylinder unit and the outdoor unit factored into the external static pressure.

■ Hydrobox

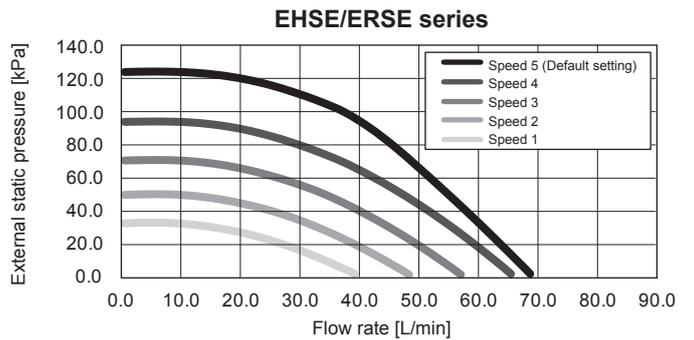
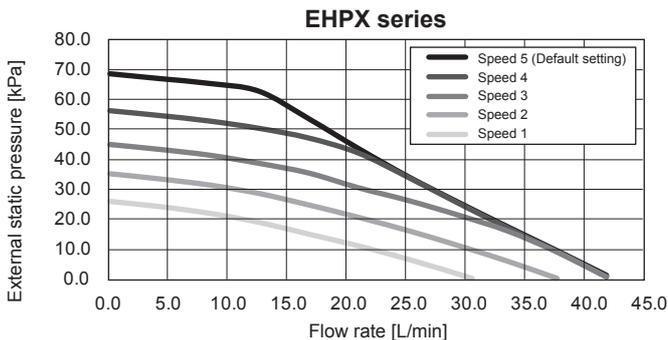
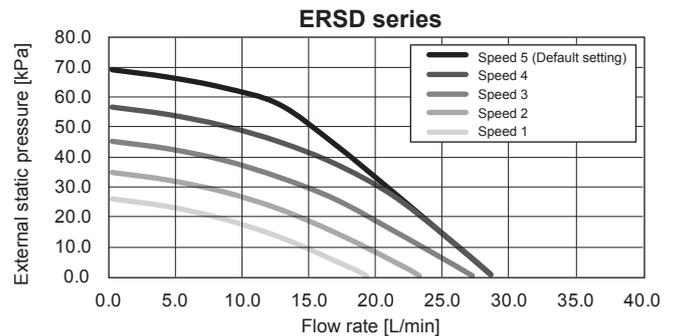
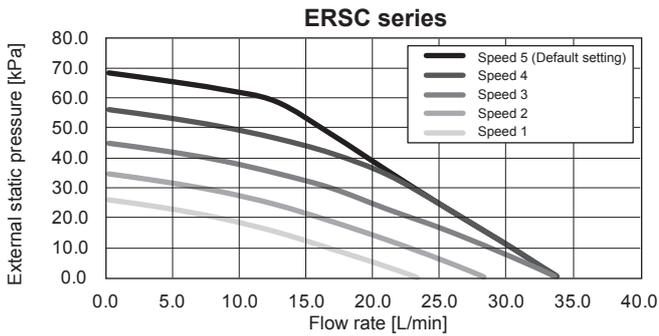
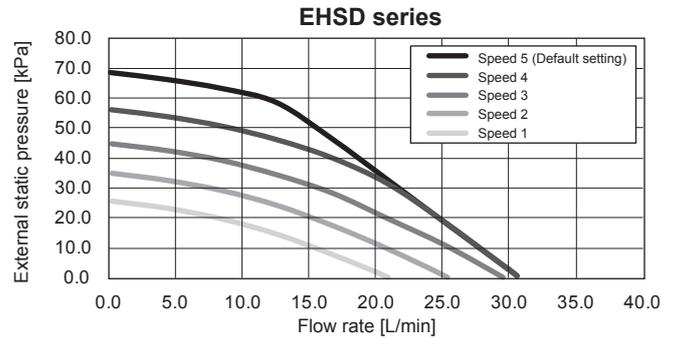
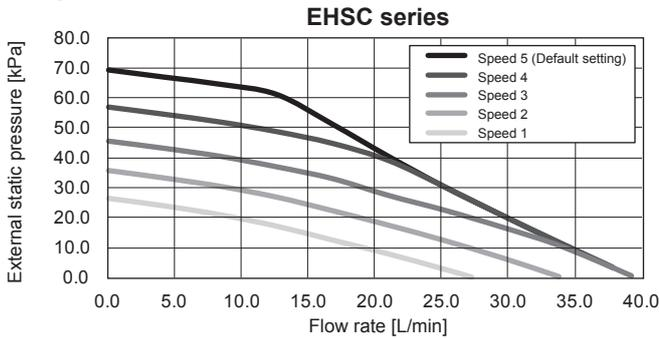

* For installation of EHPX series, set its pump speed with a pressure drop between the hydrobox and the outdoor unit factored into the external static pressure.

Safety Device Connections <Cylinder unit>

The expansion relief valve on the secondary hot water side, and the temperature and pressure (T&P) relief valve (*1), both need appropriate discharge pipework.

*1 EHPT20X-MHCW, EHST20C-MHCW and EHST20D-MHCW are equipped with T & P relief valve, and any other models are equipped with Pressure relief valve.

Note : 1. Do not secure the screws excessively when connecting the Discharge pipe, otherwise it may result in damage to the cylinder unit.

<For UK>

The right side panel has a window (*2) so that connection can be made to the factory fitted temperature and pressure relief valve. If you wish to make the connection in a different position you will have to cut a hole in the side panel yourself. However it remains necessary that the drainage parameters outlined in the appropriate Building Regulations are complied with.

*2 Unscrew the plate on the right-side panel, connect the Pressure relief valve to the discharge pipework, and refit the plate. Always replace the plate so that no gaps exist between the plate and side panel and the plate and drain pipe to avoid heat loss.

In accordance with Building Regulations a tundish must be fitted into the pipework within 500 mm of the safety device (also see Figure 4.4.1). Due to the distance between the two safety devices it may be necessary to fit each safety device with its own tundish before you run the pipework together to a safe discharge (see Figure 4.3.1).

Note : 2. Alternatively the discharges from the expansion relief valve and T&P relief valve may commonly discharge to a singular tundish, so long as this tundish is located within 500 mm of the T&P relief valve in UK. When connecting discharge pipes to the safety devices, beware not to strain the inlet connections.

Diagram part No.	Description	Connection size	Connection type
1	Expansion relief valve (part of inlet control group)	15 mm	Compression
2	Pressure relief valve	G 1/2	Female
3	T&P relief valve	15 mm /G 1/2	Compression/ Female
4	Pressure relief valve	G 1/2	Female

<Table 4.3.1>

Always refer to local regulations when installing discharge pipework. Install discharge pipework in a frost-free environment. It is necessary to provide appropriate drainage from the pressure relief valve situated on top of the cylinder unit to prevent damage to the unit and the surrounding area from any steam or hot water released. Relief valves MUST NOT be used for any other purpose.

For UK use WK01UK-E kit, for other countries please see below;

- Any discharge pipework should be capable of withstanding discharge of hot water. Discharge pipework should be installed in a continuously downward direction. Discharge pipework must be left open to the environment.

<UK models> EHPT20X-MHCW EHST20C-MHCW EHST20D-MHCW

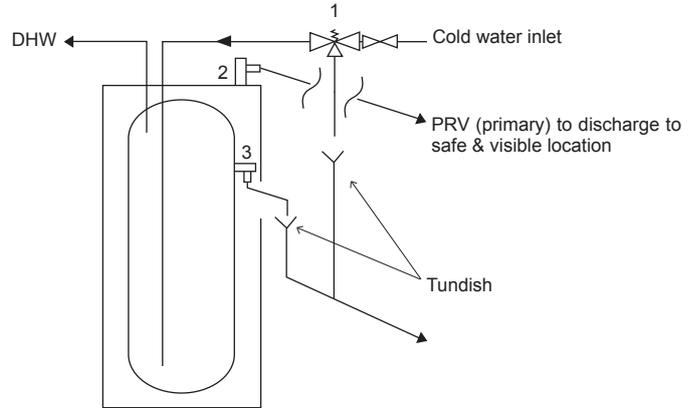

<Other models>

The expansion vessel on the sanitary water side shall be installed as necessary in accordance with your local regulations.

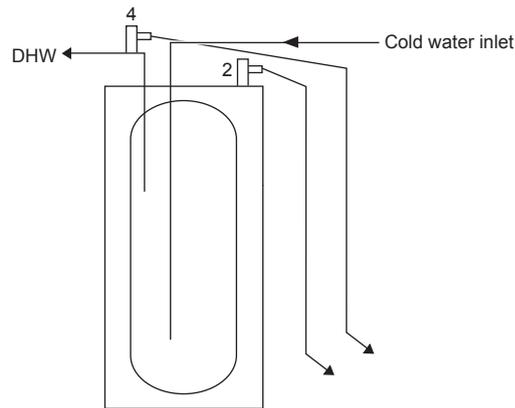

<Figure 4.3.1>

4.4 Safety Device Discharge Arrangements (G3)

The following instructions are a requirement of UK Building Regulations and must be adhered to. For other countries please refer to local legislation. If you are in any doubt please seek advice from local building planning office.

1. Position the inlet control group so that discharge from both safety valves can be joined together via a 15 mm end feed Tee.
2. Connect the tundish and route the discharge pipe as shown in Figure 4.4.1.
3. The tundish should be fitted vertically and as close to the safety device as possible and within 500 mm of the device.
4. The tundish should be visible to occupants and positioned away from electrical devices.
5. The discharge pipe (D2) from the tundish should terminate in a safe place where there is no risk to persons in the vicinity of the discharge, be of metal construction and:
 - A) Be at least one pipe size larger than the nominal outlet size of the safety device unless its total equivalent hydraulic resistance exceeds that of a straight pipe 9 m long i.e. discharge pipes between 9 m and 18 m equivalent resistance length should be at least two sizes larger than the nominal outlet size of the safety device, between 18 and 27 m at least 3 sizes larger, and so on. Bends must be taken into account in calculating the flow resistance. Refer to Figure 4.4.1, Table 4.4.1 and the worked example. An alternative approach for sizing discharge pipes would be to follow BS 6700: 1987 specification for design installation, testing and maintenance of services supplying water for domestic use within buildings and their cartilages.
 - B) Have a vertical section of pipe at least 300 mm long, below the tundish before any elbows or bends in the pipework.
 - C) Be installed with a continuous fall.
 - D) Have discharges visible at both the tundish and the final point of discharge but where this is not possible or is practically difficult there should be clear visibility at one or other of these locations. Examples of acceptable discharge arrangements are:

- i. Ideally below a fixed grating and above the water seal in a trapped gully.
- ii. Downward discharges at low level; i.e. up to 100 mm above external surfaces such as car parks, hard standings, grassed areas etc. are acceptable providing that where children may play or otherwise come into contact with discharges a wire cage or similar guard is positioned to prevent contact, whilst maintaining visibility.
- iii. Discharges at high level; e.g. into a metal hopper and metal down pipe with the end of the discharge pipe clearly visible (tundish visible or not) or onto a roof capable of withstanding high temperature discharges of water and 3 m from any plastic guttering system that would collect such discharges (tundish visible).
- iv. Where a single pipe serves a number of discharges, such as in blocks of flats, the number served should be limited to not more than 6 systems so that any installation discharging can be traced reasonably easily. The single common discharge pipe should be at least one pipe size larger than the largest individual discharge pipe (D2) to be connected. If unvented hot water storage systems are installed where discharges from safety devices may not be apparent i.e. in dwellings occupied by blind, infirm or disabled people, consideration should be given to the installation of an electronically operated device to warn when discharge takes place.

Note: The discharge will consist of scalding water and steam. Asphalt, roofing felt and nonmetallic rainwater goods may be damaged by such discharges.

Worked example: The example below is for a G½ temperature relief valve with a discharge pipe (D2) having 4 No. elbows and length of 7 m from the tundish to the point of discharge.

From Table 4.4.1: Maximum resistance allowed for a straight length of 22 mm copper discharge pipe (D2) from a G½ temperature relief valve is: 9.0 m subtract the resistance for 4 No. 22 mm elbows at 0.8 m each = 3.2 m. Therefore the maximum permitted length equates to: 5.8 m. 5.8 m is less than the actual length of 7 m, therefore calculate the next largest size. Maximum resistance allowed for a straight length of 28 mm pipe (D2) from a G½ temperature relief valve equates to: 18 m Subtract the resistance for 4 No. 28 mm elbows at 1.0 m each = 4 m. Therefore the maximum permitted length equates to: 14 m. As the actual length is 7 m, a 28 mm (D2) copper pipe will be satisfactory.

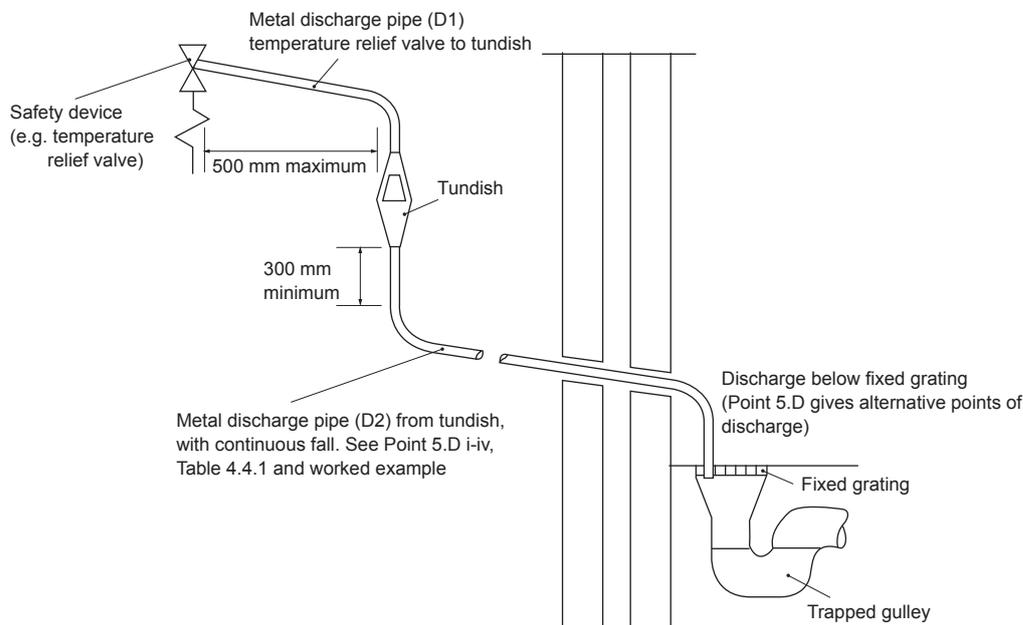

<Figure 4.4.1>

Valve outlet size	Minimum size of discharge pipe D1	Minimum size of discharge pipe D2 from tundish	Maximum resistance allowed, expressed as a length of straight pipe (no elbows or bends)	Resistance created by each elbow or bend
G 1/2	15 mm	22 mm	Up to 9 m	0.8 m
		28 mm	Up to 18 m	1.0 m
		35 mm	Up to 27 m	1.4 m
G 3/4	22 mm	28 mm	Up to 9 m	1.0 m
		35 mm	Up to 18 m	1.4 m
		42 mm	Up to 27 m	1.7 m
G1	28 mm	35 mm	Up to 9 m	1.4 m
		42 mm	Up to 18 m	1.7 m
		54 mm	Up to 27 m	2.3 m

<Table 4.4.1>

■ Safety Device Connections <Hydrobox>

The hydrobox contains a pressure relief valve. (see <Figure 4.4.2/4.4.3>) The connection size is G1/2" female. The installer MUST connect appropriate discharge pipework from this valve in accordance with local and national regulations.

Failure to do so will result in discharge from the pressure relief valve directly into the hydrobox and cause serious damage to the product.

All pipework used should be capable of withstanding discharge of hot water. Relief valves should NOT be used for any other purpose, and their discharges should terminate in a safe and appropriate manner in accordance with local regulation requirements.

Note: Beware that the manometer and the pressure relief valve are NOT strained on its capillary side and on its inlet side respectively. If a pressure relief valve is added, it is essential that no check valve or isolation valve is fitted between the hydrobox connection and the added pressure relief valve (safety matter).

(Except for EHSE/ERSE series)

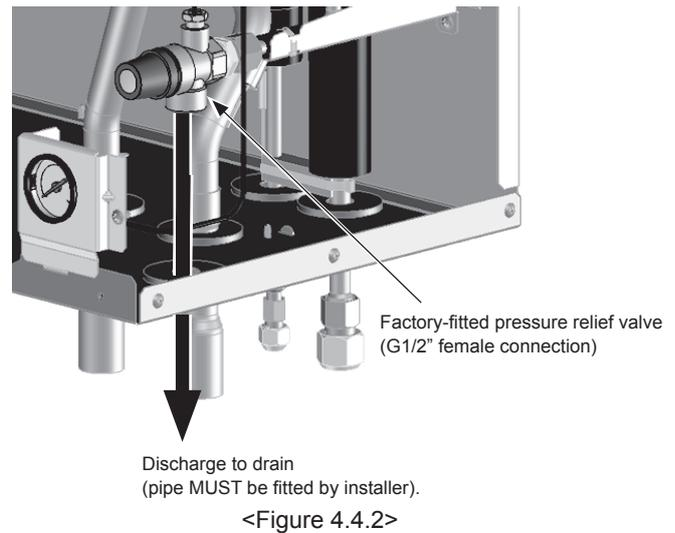

(EHSE/ERSE series)

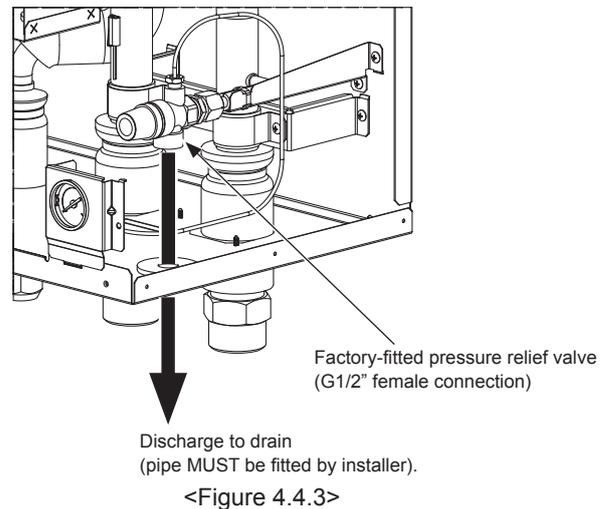

■ Piping diagram for 2-zone temperature control

Connect the pipe work and locally supplied parts according to the relevant circuit diagram shown in Section 3. Technical Information, of this manual. For more details on wiring, refer to "3.5 Wiring for 2-zone temperature controls".

Note: Do not install the thermistors on the mixing tank. This could affect correct monitoring of flow and return temperatures through each zone. Install the Zone2 flow temp. thermistor (THW8) near the mixing valve.

5.1 Combination performance

■ Combination performance (Split type)

			Cylindr unit						Hydrobox				
			ERST20D-VM2C	ERST20D-MEC	EHST20D-VM2C	EHST20D-VM2EC	EHST20D-YM9C	EHST20D-MEC	EHST20D-MHC	EHST20D-MHCW	ERSD-VM2C	EHSD-VM2C	EHSD-YM9C
Outdoor unit			SUHZ-SW45VA/VAH										
Heating A7/W35	Capacity	kW											4.50
	COP	-											5.06
	Power input(*)	kW											0.89
Heating A7/W45	Capacity	kW											4.50
	COP	-											3.70
	Power input(*)	kW											1.22
Heating A2/W35	Capacity	kW											3.50
	COP	-											3.40 / 3.04
	Power input(*)	kW											1.03 / 1.15
Cooling A35/W7	Capacity	kW	4.00							4.00			
	EER	-	2.73						2.73				
	Power input(*)	kW	1.47						1.47				
Cooling A35/W18	Capacity	kW	3.80						3.80				
	EER	-	4.28						4.28				
	Power input(*)	kW	0.89						0.89				
Outdoor unit			PUHZ-SW50VKA(-BS)										
Heating A7/W35	Capacity	kW											5.50
	COP	-											4.42
	Power input(*)	kW											1.24
Heating A7/W45	Capacity	kW											5.50
	COP	-											3.32
	Power input(*)	kW											1.66
Heating A2/W35	Capacity	kW											5.00
	COP	-											2.97
	Power input(*)	kW											1.68
Cooling A35/W7	Capacity	kW	4.50						4.50				
	EER	-	2.76						2.76				
	Power input(*)	kW	1.63						1.63				
Cooling A35/W18	Capacity	kW	5.00						5.00				
	EER	-	4.60						4.60				
	Power input(*)	kW	1.09						1.09				
Outdoor unit			PUHZ-SW75VHA(-BS)										
Heating A7/W35	Capacity	kW											8.00
	COP	-											4.40
	Power input(*)	kW											1.82
Heating A7/W45	Capacity	kW											8.00
	COP	-											3.40
	Power input(*)	kW											2.35
Heating A2/W35	Capacity	kW											7.50
	COP	-											3.40
	Power input(*)	kW											2.21
Cooling A35/W7	Capacity	kW	6.60						6.60				
	EER	-	2.82						2.82				
	Power input(*)	kW	2.34						2.34				
Cooling A35/W18	Capacity	kW	7.10						7.10				
	EER	-	4.43						4.43				
	Power input(*)	kW	1.60						1.60				
Outdoor unit			PUHZ-SW75VAA/YAA(-BS)										
Heating A7/W35	Capacity	kW											8.00
	COP	-											4.40
	Power input(*)	kW											1.82
Heating A7/W45	Capacity	kW											8.00
	COP	-											3.40
	Power input(*)	kW											2.35
Heating A2/W35	Capacity	kW											7.50
	COP	-											3.40
	Power input(*)	kW											2.21
Cooling A35/W7	Capacity	kW	7.10						7.10				
	EER	-	2.70						2.70				
	Power input(*)	kW	2.63						2.63				
Cooling A35/W18	Capacity	kW	7.10						7.10				
	EER	-	4.43						4.43				
	Power input(*)	kW	1.60						1.60				

* The pump input value is not included.

Heating A7W35: Heating outside air DB 7°C/WB 6°C, Water outlet temperature 35°C (ΔT=5°C)

A7W45: Heating outside air DB 7°C/WB 6°C, Water outlet temperature 45°C (ΔT=5°C)

A2W35: Heating outside air DB 2°C/WB 1°C, Water outlet temperature 35°C (ΔT=5°C)

Cooling A35/W7: Cooling outside air DB 35°C, Water outlet temperature 7°C (ΔT=5°C)

A35/W18: Cooling outside air DB 35°C, Water outlet temperature 18°C (ΔT=5°C)

■ Combination performance (Split type)

			Cylinder unit										Hydrobox													
			ERST20C-VM2C	ERST20C-MEC	EHST20C-VM2C	EHST20C-VM6C	EHST20C-VM9C	EHST20C-TM9C	EHST20C-VM2EC	EHST20C-VM6EC	EHST20C-VM9EC	EHST20C-MEC	EHST20C-MHCW	ERSC-VM2C	ERSC-MEC	EHSC-VM2C	EHSC-VM6C	EHSC-VM9C	EHSC-TM9C	EHSC-VM2EC	EHSC-VM6EC	EHSC-VM9EC	EHSC-MEC			
Outdoor unit			PUHZ-SW75VHA(-BS)																							
Heating A7/W35	Capacity	kW																		8.00						
	COP	-																		4.40						
	Power input(*)	kW																		1.82						
Heating A7/W45	Capacity	kW																		8.00						
	COP	-																		3.40						
	Power input(*)	kW																		2.35						
Heating A2/W35	Capacity	kW																		7.50						
	COP	-																		3.40						
	Power input(*)	kW																		2.21						
Cooling A35/W7	Capacity	kW	6.60																				6.60			
	EER	-	2.82																					2.82		
	Power input(*)	kW	2.34																					2.34		
Cooling A35/W18	Capacity	kW	7.10																					7.10		
	EER	-	4.43																					4.43		
	Power input(*)	kW	1.60																					1.60		
Outdoor unit			PUHZ-SW100VHA/YHA(-BS)																							
Heating A7/W35	Capacity	kW																		11.20						
	COP	-																		4.45						
	Power input(*)	kW																		2.51						
Heating A7/W45	Capacity	kW																		11.20						
	COP	-																		3.42						
	Power input(*)	kW																		3.28						
Heating A2/W35	Capacity	kW																		10.00						
	COP	-																		3.32						
	Power input(*)	kW																		3.01						
Cooling A35/W7	Capacity	kW	9.10																					9.10		
	EER	-	2.75																					2.75		
	Power input(*)	kW	3.31																					3.31		
Cooling A35/W18	Capacity	kW	10.00																					10.00		
	EER	-	4.35																					4.35		
	Power input(*)	kW	2.30																					2.30		
Outdoor unit			PUHZ-SW120VHA/YHA(-BS)																							
Heating A7/W35	Capacity	kW																		16.00						
	COP	-																		4.10						
	Power input(*)	kW																		3.90						
Heating A7/W45	Capacity	kW																		16.00						
	COP	-																		3.23						
	Power input(*)	kW																		4.95						
Heating A2/W35	Capacity	kW																		12.00						
	COP	-																		3.24						
	Power input(*)	kW																		3.70						
Cooling A35/W7	Capacity	kW	12.50																					12.50		
	EER	-	2.32																					2.32		
	Power input(*)	kW	5.39																					5.39		
Cooling A35/W18	Capacity	kW	14.00																					14.00		
	EER	-	4.08																					4.08		
	Power input(*)	kW	3.43																					3.43		
Outdoor unit			PUHZ-SW100VAA/YAA(-BS)																							
Heating A7/W35	Capacity	kW																		11.20						
	COP	-																		4.46						
	Power input(*)	kW																		2.51						
Heating A7/W45	Capacity	kW																		11.20						
	COP	-																		3.42						
	Power input(*)	kW																		3.27						
Heating A2/W35	Capacity	kW																		10.0						
	COP	-																		3.32						
	Power input(*)	kW																		3.01						
Cooling A35/W7	Capacity	kW	10.00																					10.00		
	EER	-	2.83																					2.83		
	Power input(*)	kW	3.53																					3.53		
Cooling A35/W18	Capacity	kW	10.00																					10.00		
	EER	-	4.47																					4.47		
	Power input(*)	kW	2.24																					2.24		
Outdoor unit			PUHZ-FRP71VHA2																							
Heating A7/W35	Capacity	kW																		8.00						
	COP	-																		4.08						
	Power input(*)	kW																		1.96						
Heating A7/W45	Capacity	kW																		8.00						
	COP	-																		3.22						
	Power input(*)	kW																		2.48						
Heating A2/W35	Capacity	kW																		7.50						
	COP	-																		2.83						
	Power input(*)	kW																		2.65						
Cooling A35/W7	Capacity	kW																		-						
	EER	-																		-						
	Power input(*)	kW																		-						
Cooling A35/W18	Capacity	kW																		-						
	EER	-																		-						
	Power input(*)	kW																		-						

* The pump input value is not included.

Heating A7W35: Heating outside air DB 7°C/WB 6°C, Water outlet temperature 35°C (ΔT=5°C)
 A7W45: Heating outside air DB 7°C/WB 6°C, Water outlet temperature 45°C (ΔT=5°C)
 A2W35: Heating outside air DB 2°C/WB 1°C, Water outlet temperature 35°C (ΔT=5°C)

Cooling A35W7: Cooling outside air DB 35°C, Water outlet temperature 7°C (ΔT=5°C)
 A35W18: Cooling outside air DB 35°C, Water outlet temperature 18°C (ΔT=5°C)

■ Combination performance (Split type)

			Cylinder unit										Hydrobox														
			ERST20C-VM2C	ERST20C-MEC	EHST20C-VM2C	EHST20C-VM6C	EHST20C-VM9C	EHST20C-TM9C	EHST20C-VM2EC	EHST20C-VM6EC	EHST20C-VM9EC	EHST20C-MEC	EHST20C-MHCW	ERSC-VM2C	ERSC-MEC	EHSC-VM2C	EHSC-VM6C	EHSC-VM9C	EHSC-TM9C	EHSC-VM2EC	EHSC-VM6EC	EHSC-VM9EC	EHSC-MEC				
Outdoor unit			PUHZ-SHW80VHA(-BS)																								
Heating A7/W35	Capacity	kW																					8.00				
	COP	-																					4.65				
	Power input(*)	kW																					1.72				
Heating A7/W45	Capacity	kW																					8.00				
	COP	-																					3.42				
	Power input(*)	kW																					2.34				
Heating A2/W35	Capacity	kW																					8.00				
	COP	-																					3.55				
	Power input(*)	kW																					2.25				
Cooling A35/W7	Capacity	kW	7.10																					7.10			
	EER	-	3.31																						3.31		
	Power input(*)	kW	2.15																						2.15		
Cooling A35/W18	Capacity	kW	7.10																						7.10		
	EER	-	4.52																						4.52		
	Power input(*)	kW	1.57																						1.57		
Outdoor unit			PUHZ-SHW112VHA/YHA(-BS)																								
Heating A7/W35	Capacity	kW																					11.20				
	COP	-																					4.46				
	Power input(*)	kW																					2.51				
Heating A7/W45	Capacity	kW																					11.20				
	COP	-																					3.51				
	Power input(*)	kW																					3.20				
Heating A2/W35	Capacity	kW																					11.20				
	COP	-																					3.34				
	Power input(*)	kW																					3.35				
Cooling A35/W7	Capacity	kW	10.00																						10.00		
	EER	-	2.83																						2.83		
	Power input(*)	kW	3.53																						3.53		
Cooling A35/W18	Capacity	kW	10.00																						10.00		
	EER	-	4.74																						4.74		
	Power input(*)	kW	2.11																						2.11		
Outdoor unit			PUHZ-SHW140YHA(-BS)																								
Heating A7/W35	Capacity	kW																					14.00				
	COP	-																					4.22				
	Power input(*)	kW																					3.32				
Heating A7/W45	Capacity	kW																					14.00				
	COP	-																					3.28				
	Power input(*)	kW																					4.27				
Heating A2/W35	Capacity	kW																					14.00				
	COP	-																					2.96				
	Power input(*)	kW																					4.73				
Cooling A35/W7	Capacity	kW	12.50																						12.50		
	EER	-	2.17																						2.17		
	Power input(*)	kW	5.76																						5.76		
Cooling A35/W18	Capacity	kW	12.50																						12.50		
	EER	-	4.26																						4.26		
	Power input(*)	kW	2.93																						2.93		
Outdoor unit			PUHZ-SHW80VAA/YAA(-BS)																								
Heating A7/W35	Capacity	kW																					8.00				
	COP	-																					4.65				
	Power input(*)	kW																					1.72				
Heating A7/W45	Capacity	kW																					8.00				
	COP	-																					3.42				
	Power input(*)	kW																					2.34				
Heating A2/W35	Capacity	kW																					8.00				
	COP	-																					3.55				
	Power input(*)	kW																					2.25				
Cooling A35/W7	Capacity	kW	7.10																						7.10		
	EER	-	3.31																						3.31		
	Power input(*)	kW	2.15																						2.15		
Cooling A35/W18	Capacity	kW	7.10																						7.10		
	EER	-	4.52																						4.52		
	Power input(*)	kW	1.57																						1.57		
Outdoor unit			PUHZ-SHW112VAA/YAA(-BS)																								
Heating A7/W35	Capacity	kW																					11.20				
	COP	-																					4.46				
	Power input(*)	kW																					2.51				
Heating A7/W45	Capacity	kW																					11.20				
	COP	-																					3.42				
	Power input(*)	kW																					3.27				
Heating A2/W35	Capacity	kW																					11.20				
	COP	-																					3.22				
	Power input(*)	kW																					3.48				
Cooling A35/W7	Capacity	kW	10.00																						10.00		
	EER	-	2.83																						2.83		
	Power input(*)	kW	3.53																						3.53		
Cooling A35/W18	Capacity	kW	10.00																						10.00		
	EER	-	4.74																						4.74		
	Power input(*)	kW	2.11																						2.11		

* The pump input value is not included.

Heating A7W35: Heating outside air DB 7°C/WB 6°C, Water outlet temperature 35°C (ΔT=5°C)
 A7W45: Heating outside air DB 7°C/WB 6°C, Water outlet temperature 45°C (ΔT=5°C)
 A2W35: Heating outside air DB 2°C/WB 1°C, Water outlet temperature 35°C (ΔT=5°C)

Cooling A35/W7: Cooling outside air DB 35°C, Water outlet temperature 7°C (ΔT=5°C)
 A35/W18: Cooling outside air DB 35°C, Water outlet temperature 18°C (ΔT=5°C)

■ Combination performance (Split type)

■ Combination performance (Package type)

Cylinder / Hydrobox

			Hydrobox			
			ERSE-YM9EC	ERSE-MEC	EHSE-YM9EC	EHSE-MEC
Outdoor unit			PUHZ-SW160YKA(-BS)			
Heating A7/W35	Capacity	kW	22.00			
	COP	-	4.20			
	Power input(*)	kW	5.24			
Heating A7/W45	Capacity	kW	22.00			
	COP	-	3.20			
	Power input(*)	kW	6.88			
Heating A2/W35	Capacity	kW	16.00			
	COP	-	3.11			
	Power input(*)	kW	5.14			
Cooling A35/W7	Capacity	kW	16.00	-	-	
	EER	-	2.76	-	-	
	Power input(*)	kW	5.80	-	-	
Cooling A35/W18	Capacity	kW	18.00	-	-	
	EER	-	4.56	-	-	
	Power input(*)	kW	3.95	-	-	
Outdoor unit			PUHZ-SW200YKA(-BS)			
Heating A7/W35	Capacity	kW	25.00			
	COP	-	4.00			
	Power input(*)	kW	6.25			
Heating A7/W45	Capacity	kW	25.00			
	COP	-	3.10			
	Power input(*)	kW	8.06			
Heating A2/W35	Capacity	kW	20.00			
	COP	-	2.80			
	Power input(*)	kW	7.14			
Cooling A35/W7	Capacity	kW	20.00	-	-	
	EER	-	2.25	-	-	
	Power input(*)	kW	8.89	-	-	
Cooling A35/W18	Capacity	kW	22.00	-	-	
	EER	-	4.10	-	-	
	Power input(*)	kW	5.37	-	-	
Outdoor unit			PUHZ-SHW230YKA2			
Heating A7/W35	Capacity	kW	23.00			
	COP	-	3.65			
	Power input(*)	kW	6.31			
Heating A7/W45	Capacity	kW	23.00			
	COP	-	3.02			
	Power input(*)	kW	7.62			
Heating A2/W35	Capacity	kW	23.00			
	COP	-	2.37			
	Power input(*)	kW	9.71			
Cooling A35/W7	Capacity	kW	20.00	-	-	
	EER	-	2.22	-	-	
	Power input(*)	kW	9.01	-	-	
Cooling A35/W18	Capacity	kW	20.00	-	-	
	EER	-	3.55	-	-	
	Power input(*)	kW	5.63	-	-	

* The pump input value is not included.

Heating A7/W35: Heating outside air DB 7°C/WB 6°C, Water outlet temperature 35°C (ΔT=5°C)
 A7/W45: Heating outside air DB 7°C/WB 6°C, Water outlet temperature 45°C (ΔT=5°C)
 A2/W35: Heating outside air DB 2°C/WB 1°C, Water outlet temperature 35°C (ΔT=5°C)
 Cooling A35/W7: Cooling outside air DB 35°C, Water outlet temperature 7°C (ΔT=5°C)
 A35/W18: Cooling outside air DB 35°C, Water outlet temperature 18°C (ΔT=5°C)

			Cylinder unit					Hydrobox		
			EHPT20X-VM2C	EHPT20X-VM6C	EHPT20X-VM9C	EHPT20X-TM9C	EHPT20X-MHCW	EHPX-VM2C	EHPX-VM6C	EHPX-VM9C
Outdoor unit			PUHZ-W50VHA2(-BS)							
Heating A7/W35	Capacity	kW	5.00							
	COP	-	4.50							
	Power input(**)	kW	1.11							
Heating A7/W45	Capacity	kW	5.00							
	COP	-	3.52							
	Power input(**)	kW	1.42							
Heating A2/W35	Capacity	kW	5.00							
	COP	-	3.50							
	Power input(**)	kW	1.43							
Outdoor unit			PUHZ-W85VHA2(-BS)							
Heating A7/W35	Capacity	kW	9.00							
	COP	-	4.18							
	Power input(**)	kW	2.15							
Heating A7/W45	Capacity	kW	9.00							
	COP	-	3.24							
	Power input(**)	kW	2.78							
Heating A2/W35	Capacity	kW	8.50							
	COP	-	3.17							
	Power input(**)	kW	2.68							
Outdoor unit			PUHZ-W85VAA/YAA							
Heating A7/W35	Capacity	kW	9.00							
	COP	-	4.51							
	Power input(**)	kW	2.00							
Heating A7/W45	Capacity	kW	9.00							
	COP	-	3.41							
	Power input(**)	kW	2.64							
Heating A2/W35	Capacity	kW	8.50							
	COP	-	3.36							
	Power input(**)	kW	2.53							
Outdoor unit			PUHZ-W112VAA/YAA							
Heating A7/W35	Capacity	kW	11.2							
	COP	-	4.54							
	Power input(**)	kW	2.47							
Heating A7/W45	Capacity	kW	11.2							
	COP	-	3.42							
	Power input(**)	kW	3.28							
Heating A2/W35	Capacity	kW	11.2							
	COP	-	3.34							
	Power input(**)	kW	3.35							
Outdoor unit			PUHZ-HW112YHA2(-BS)							
Heating A7/W35	Capacity	kW	11.20							
	COP	-	4.47							
	Power input(**)	kW	2.51							
Heating A7/W45	Capacity	kW	11.20							
	COP	-	3.45							
	Power input(**)	kW	3.25							
Heating A2/W35	Capacity	kW	11.20							
	COP	-	3.34							
	Power input(**)	kW	3.35							
Outdoor unit			PUHZ-HW112YHA2(-BS)							
Heating A7/W35	Capacity	kW	11.20							
	COP	-	4.43							
	Power input(**)	kW	2.53							
Heating A7/W45	Capacity	kW	11.20							
	COP	-	3.39							
	Power input(**)	kW	3.30							
Heating A2/W35	Capacity	kW	11.20							
	COP	-	3.11							
	Power input(**)	kW	3.60							
Outdoor unit			PUHZ-HW140VHA2/YHA2(-BS)							
Heating A7/W35	Capacity	kW	14.00							
	COP	-	4.26							
	Power input(**)	kW	3.29							
Heating A7/W45	Capacity	kW	14.00							
	COP	-	3.35							
	Power input(**)	kW	4.18							
Heating A2/W35	Capacity	kW	14.00							
	COP	-	3.11							
	Power input(**)	kW	4.50							

** The pump input value is included (based on EN 14511).

Heating A7/W35: Heating outside air DB 7°C/WB 6°C, Water outlet temperature 35°C (ΔT=5°C)
 A7/W45: Heating outside air DB 7°C/WB 6°C, Water outlet temperature 45°C (ΔT=5°C)
 A2/W35: Heating outside air DB 2°C/WB 1°C, Water outlet temperature 35°C (ΔT=5°C)

■ Combination performance (Split type)

			Cylinder unit								Hydrobox					
			EHST20C-VM2C	EHST20C-VM6C	EHST20C-VM9C	EHST20C-TM9C	EHST20C-VM2EC	EHST20C-VM6EC	EHST20C-VM9EC	EHST20C-MHCW	EHSC-VM2C	EHSC-VM2EC	EHSC-VM6C	EHSC-VM6EC	EHSC-VM9C	EHSC-VM9EC
Outdoor unit			PUMY-P112V/YKM(E)4(-BS)													
Heating A7/W35	Capacity	kW	12.50													
	COP(*)	-	4.08													
	Power input(**)	kW	3.06													
Heating A7/W45	Capacity	kW	12.50													
	COP(*)	-	3.06													
	Power input(**)	kW	4.08													
Heating A2/W35	Capacity	kW	10.00													
	COP(*)	-	2.86													
	Power input(**)	kW	3.50													
Outdoor unit			PUMY-P125V/YKM(E)4(-BS)													
Heating A7/W35	Capacity	kW	12.50													
	COP(*)	-	4.08													
	Power input(**)	kW	3.06													
Heating A7/W45	Capacity	kW	12.50													
	COP(*)	-	3.06													
	Power input(**)	kW	4.08													
Heating A2/W35	Capacity	kW	10.00													
	COP(*)	-	2.86													
	Power input(**)	kW	3.50													
Outdoor unit			PUMY-P140V/YKM(E)4(-BS)													
Heating A7/W35	Capacity	kW	12.50													
	COP(*)	-	4.08													
	Power input(**)	kW	3.06													
Heating A7/W45	Capacity	kW	12.50													
	COP(*)	-	3.06													
	Power input(**)	kW	4.08													
Heating A2/W35	Capacity	kW	10.00													
	COP(*)	-	2.86													
	Power input(**)	kW	3.50													

* In case of ATW unit single connection.

** The pump input value is not included.

A7W35: Heating outside air DB 7°C/WB 6°C, Water outlet temperature 35°C (ΔT=5°C)

A7W45: Heating outside air DB 7°C/WB 6°C, Water outlet temperature 45°C (ΔT=5°C)

A2W35: Heating outside air DB 2°C/WB 1°C, Water outlet temperature 35°C (ΔT=5°C)

5.2 Heat time data (DHW mode)

■ PUAZ-W50VHA2(-BS)

Heat time

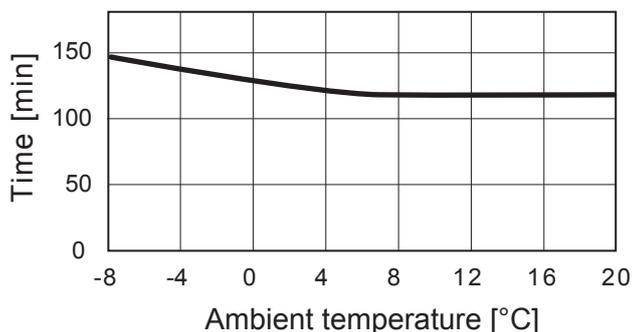

- Mitsubishi's domestic hot water tank (200 [L])
- Time to raise DHW tank temperature 15 – 55[°C]

Reheat time

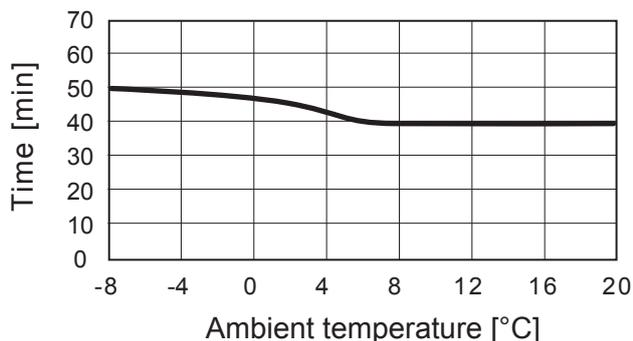

- Mitsubishi's domestic hot water tank (200 [L])
- Time to reheat 50% (100 [L]) of DHW tank to 55 [°C]

■ PUAZ-W85VHA2(-BS)

Heat time

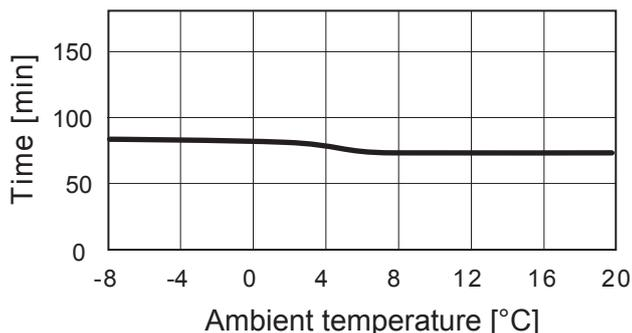

- Mitsubishi's domestic hot water tank (200 [L])
- Time to raise DHW tank temperature 15 – 55 [°C]

Reheat time

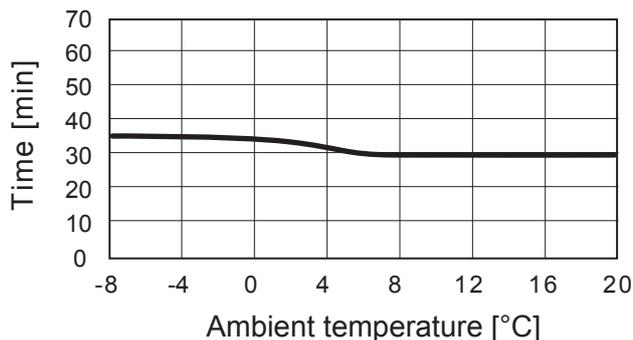

- Mitsubishi's domestic hot water tank (200 [L])
- Time to reheat 50% (100 [L]) of DHW tank to 55 [°C]

■ PUAZ-W112VHA(-BS)

Heat time

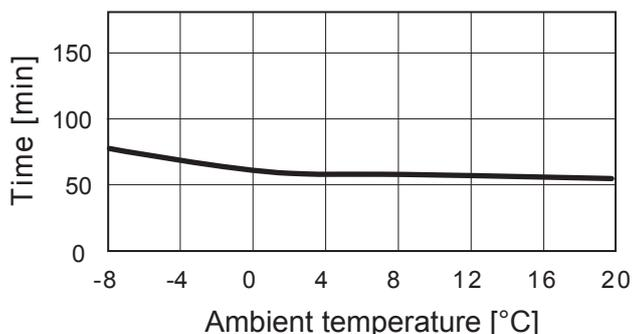

- Mitsubishi's domestic hot water tank (200 [L])
- Time to raise DHW tank temperature 15 – 55 [°C]

Reheat time

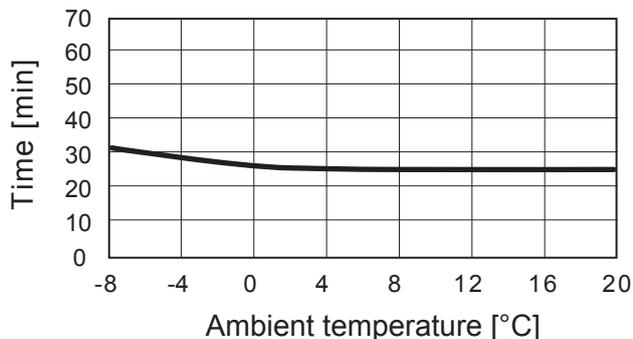

- Mitsubishi's domestic hot water tank (200 [L])
- Time to reheat 50% (100 [L]) of DHW tank to 55 [°C]

■ PUAZ-HW112YHA2(-BS)

Heat time

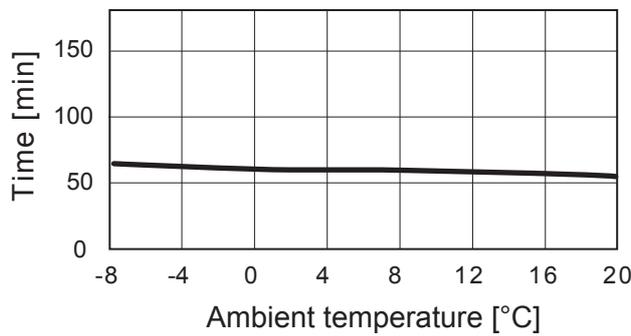

	Ambient temperature [°C]			
	-7	2	7	20
Heat time(min)	65	60	60	55

- Mitsubishi's domestic hot water tank (200 [L])
- Time to raise DHW tank temperature 15 – 55 [°C]

Reheat time

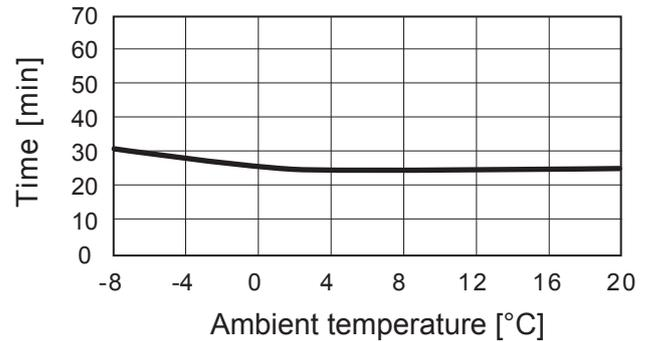

	Ambient temperature [°C]			
	-7	2	7	20
Reheat time(min)	30	25	25	25

- Mitsubishi's domestic hot water tank (200 [L])
- Time to reheat 50% (100 [L]) of DHW tank to 55 [°C]

■ PUAZ-HW140VHA2/YHA2(-BS)

Heat time

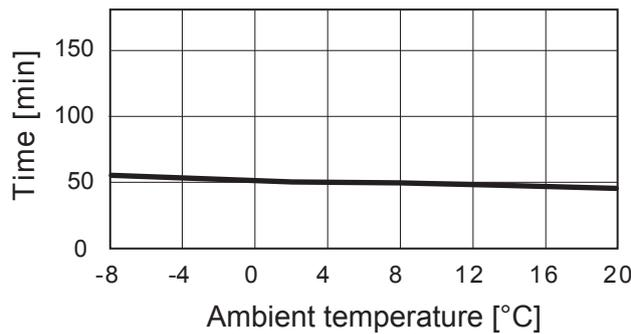

	Ambient temperature [°C]			
	-7	2	7	20
Heat time(min)	55	50	50	45

- Mitsubishi's domestic hot water tank (200 [L])
- Time to raise DHW tank temperature 15 – 55 [°C]

Reheat time

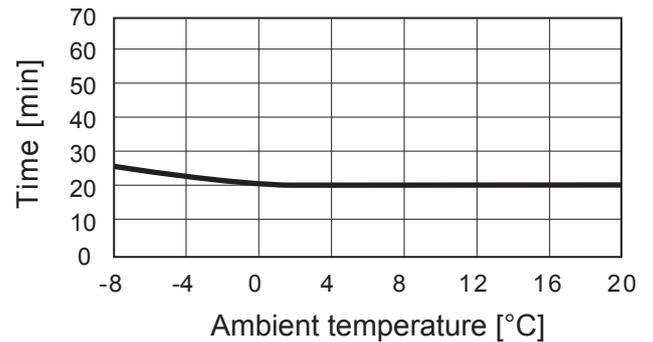

	Ambient temperature [°C]			
	-7	2	7	20
Reheat time(min)	25	20	20	20

- Mitsubishi's domestic hot water tank (200 [L])
- Time to reheat 50% (100 [L]) of DHW tank to 55 [°C]

■ PUAZ-W85VAA/YAA(-BS)

Heat time

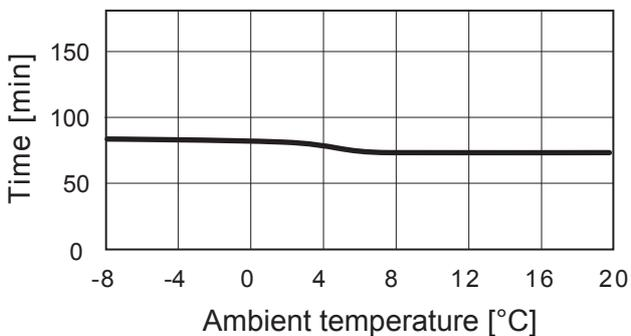

	Ambient temperature [°C]			
	-7	2	7	20
Heat time (min)	85	80	75	75

- Mitsubishi's domestic hot water tank (200 [L])
- Time to raise DHW tank temperature 15 – 55 [°C]

Reheat time

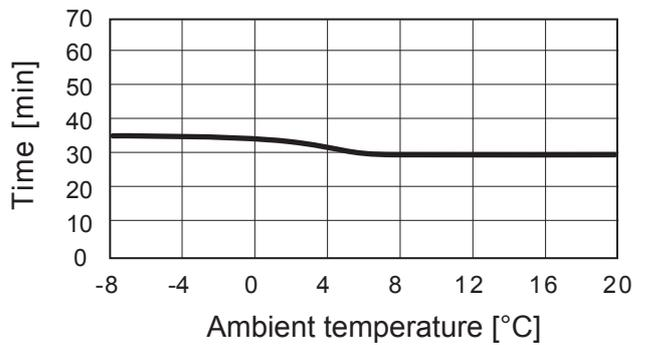

	Ambient temperature [°C]			
	-7	2	7	20
Reheat time (min)	35	35	30	30

- Mitsubishi's domestic hot water tank (200 [L])
- Time to reheat 50% (100 [L]) of DHW tank to 55 [°C]

■ PUAZ-W112VAA/YAA(-BS)

Heat time

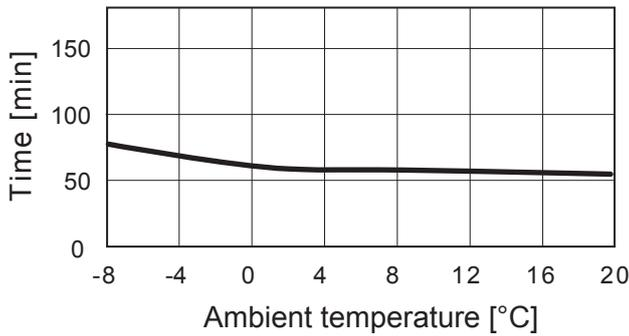

	Ambient temperature [°C]			
	-7	2	7	20
Heat time (min)	75	60	60	55

- Mitsubishi's domestic hot water tank (200 [L])
- Time to raise DHW tank temperature 15 – 55 [°C]

Reheat time

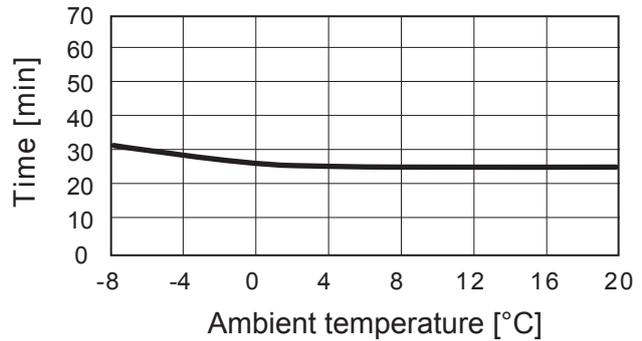

	Ambient temperature [°C]			
	-7	2	7	20
Reheat time (min)	31	25	25	25

- Mitsubishi's domestic hot water tank (200 [L])
- Time to reheat 50% (100 [L]) of DHW tank to 55 [°C]

■ SUHZ-SW45VA(H)

Heat time

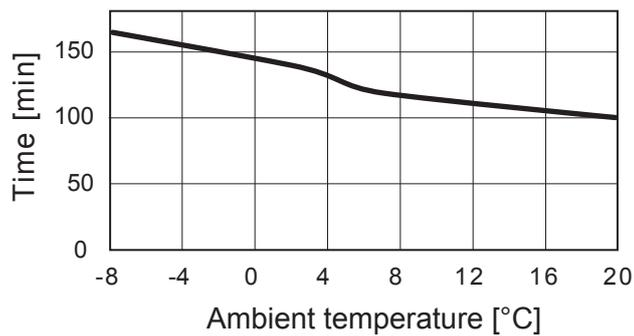

	Ambient temperature [°C]			
	-7	2	7	20
Heat time (min)	165	140	120	100

- Mitsubishi's domestic hot water tank (200 [L])
- Time to raise DHW tank temperature 15 – 55 [°C]

Reheat time

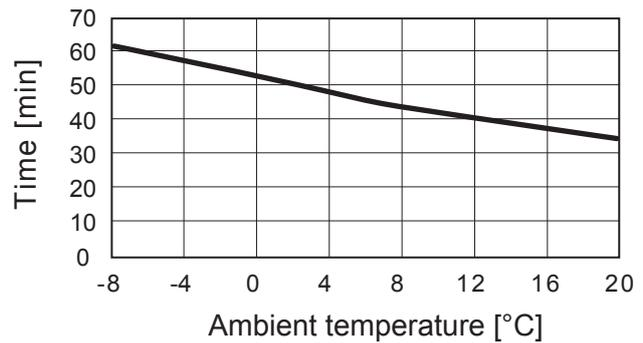

	Ambient temperature [°C]			
	-7	2	7	20
Reheat time (min)	60	50	44	35

- Mitsubishi's domestic hot water tank (200 [L])
- Time to reheat 50% (100 [L]) of DHW tank to 55 [°C]

■ PUAZ-SW50VKA(-BS)

Heat time

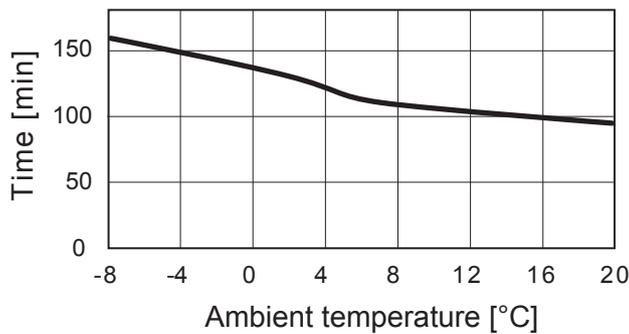

	Ambient temperature [°C]			
	-7	2	7	20
Heat time (min)	160	130	110	95

- Mitsubishi's domestic hot water tank (200 [L])
- Time to raise DHW tank temperature 15 – 55 [°C]

Reheat time

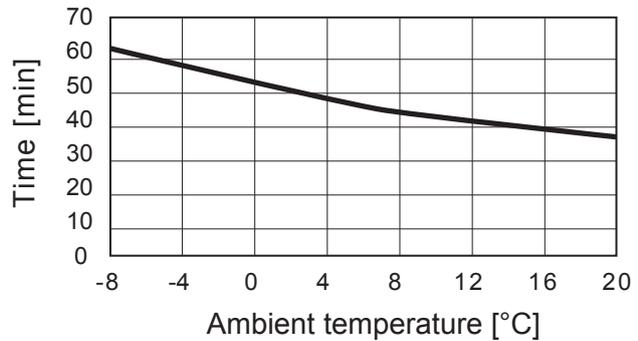

	Ambient temperature [°C]			
	-7	2	7	20
Reheat time (min)	58	48	42	34

- Mitsubishi's domestic hot water tank (200 [L])
- Time to reheat 50% (100 [L]) of DHW tank to 55 [°C]

■ PUAZ-SW75VHA(-BS)

Heat time

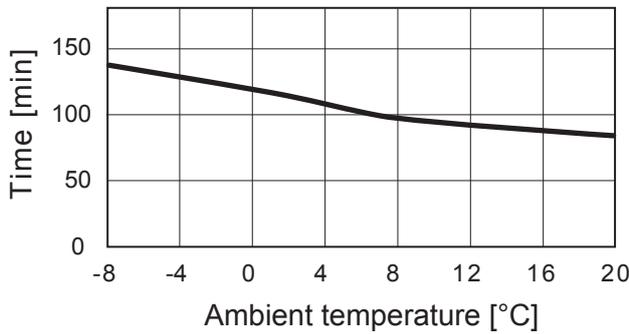

	Ambient temperature [°C]			
	-7	2	7	20
Heat time (min)	135	115	100	85

- Mitsubishi's domestic hot water tank (200 [L])
- Time to raise DHW tank temperature 15 – 55 [°C]

Reheat time

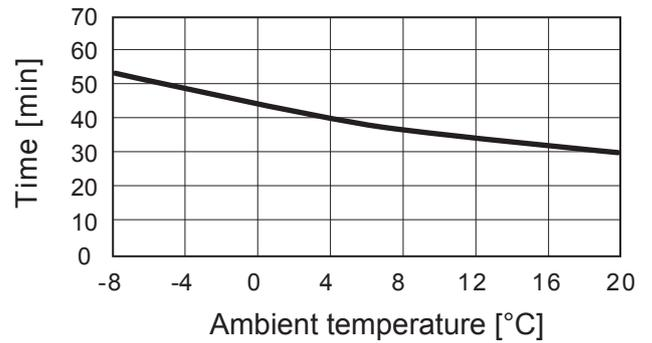

	Ambient temperature [°C]			
	-7	2	7	20
Reheat time (min)	52	44	36	30

- Mitsubishi's domestic hot water tank (200 [L])
- Time to reheat 50% (100 [L]) of DHW tank to 55 [°C]

■ PUAZ-SW100VHA/YHA(-BS)

Heat time

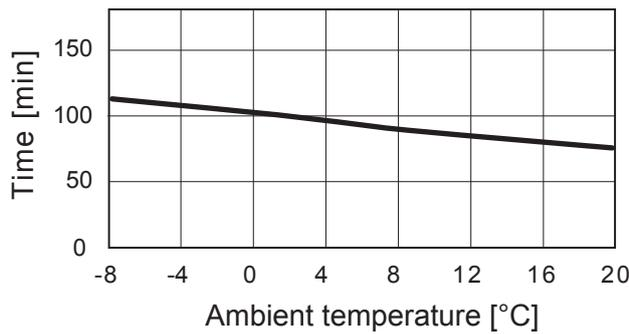

	Ambient temperature [°C]			
	-7	2	7	20
Heat time (min)	110	100	90	75

- Mitsubishi's domestic hot water tank (200 [L])
- Time to raise DHW tank temperature 15 – 55 [°C]

Reheat time

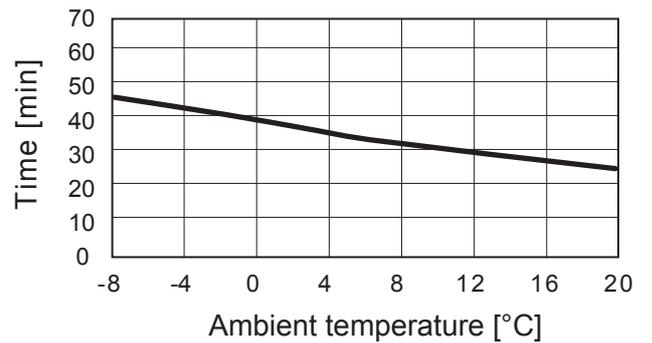

	Ambient temperature [°C]			
	-7	2	7	20
Reheat time (min)	46	40	34	26

- Mitsubishi's domestic hot water tank (200 [L])
- Time to reheat 50% (100 [L]) of DHW tank to 55 [°C]

■ PUAZ-SW120VHA/YHA(-BS)

Heat time

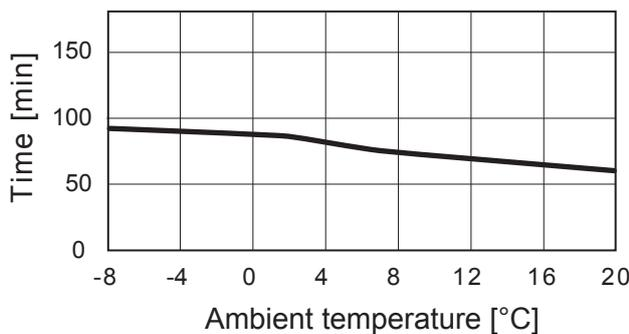

	Ambient temperature [°C]			
	-7	2	7	20
Heat time(min)	90	85	75	60

- Mitsubishi's domestic hot water tank (200 [L])
- Time to raise DHW tank temperature 15 – 55 [°C]

Reheat time

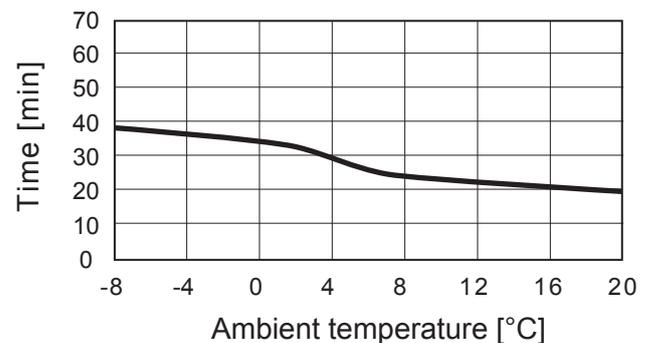

	Ambient temperature [°C]			
	-7	2	7	20
Reheat time(min)	38	32	25	20

- Mitsubishi's domestic hot water tank (200 [L])
- Time to reheat 50% (100 [L]) of DHW tank to 55 [°C]

■ PUAZ-SW75VAA/YAA(-BS)

Heat time

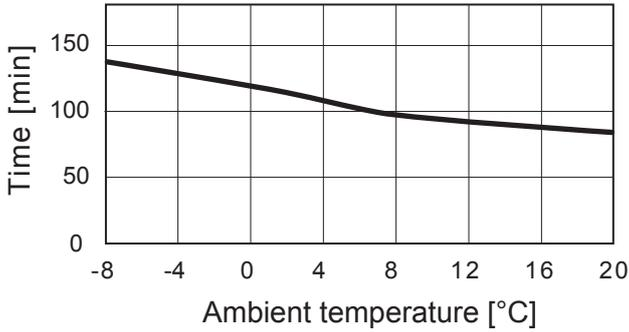

- Mitsubishi's domestic hot water tank (200 [L])
- Time to raise DHW tank temperature 15 – 55 [°C]

Reheat time

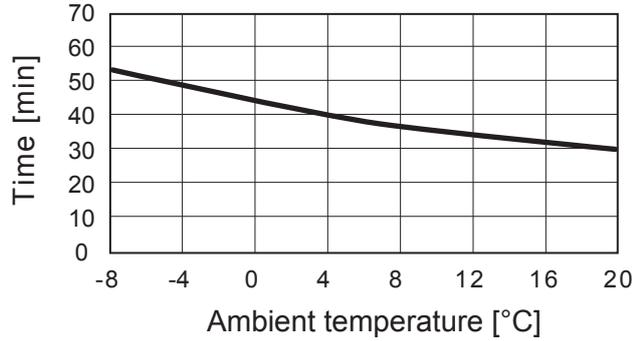

- Mitsubishi's domestic hot water tank (200 [L])
- Time to reheat 50% (100 [L]) of DHW tank to 55 [°C]

■ PUAZ-SW100VAA/YAA(-BS)

Heat time

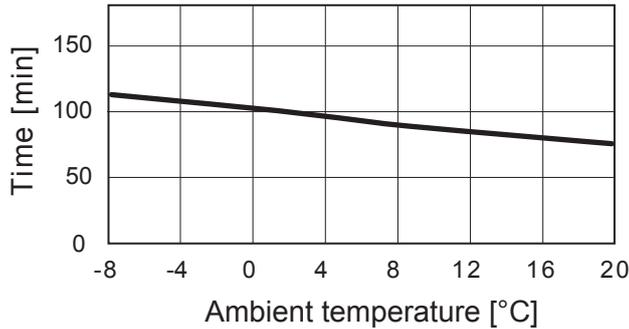

- Mitsubishi's domestic hot water tank (200 [L])
- Time to raise DHW tank temperature 15 – 55 [°C]

Reheat time

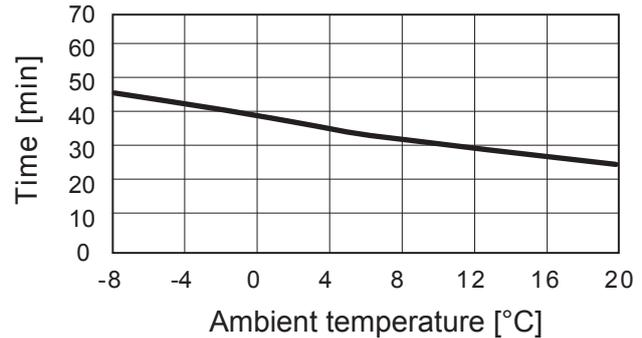

- Mitsubishi's domestic hot water tank (200 [L])
- Time to reheat 50% (100 [L]) of DHW tank to 55 [°C]

■ PUAZ-FRP71VHA2

Heat time

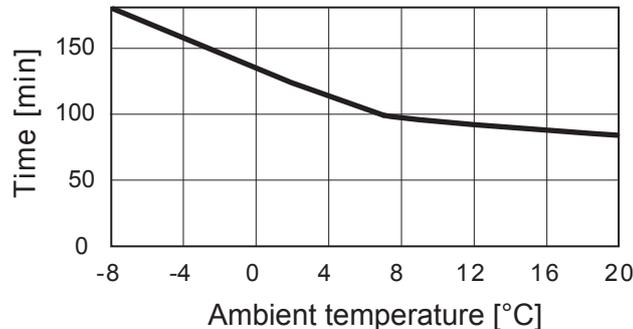

- Mitsubishi's domestic hot water tank (200 [L])
- Time to raise DHW tank temperature 15 – 55 [°C]

Reheat time

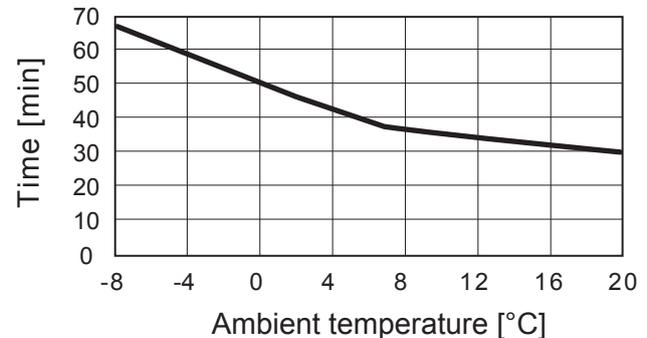

- Mitsubishi's domestic hot water tank (200 [L])
- Time to reheat 50% (100 [L]) of DHW tank to 55 [°C]

■ PUAZ-SHW80VHA(-BS)

Heat time

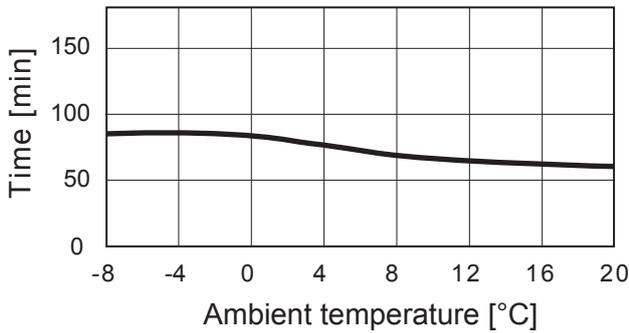

	Ambient temperature [°C]			
	-7	2	7	20
Heat time (min)	85	80	70	60

- Mitsubishi's domestic hot water tank (200 [L])
- Time to raise DHW tank temperature 15 – 55[°C]

Reheat time

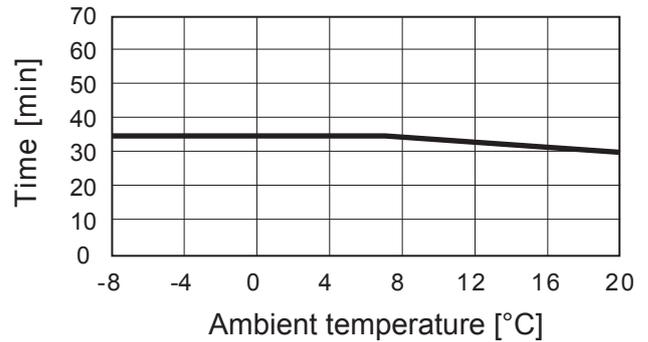

	Ambient temperature [°C]			
	-7	2	7	20
Reheat time (min)	35	35	35	30

- Mitsubishi's domestic hot water tank (200 [L])
- Time to reheat 50%(100 [L]) of DHW tank to 55 [°C]

■ PUAZ-SHW112VHA/YHA(-BS)

Heat time

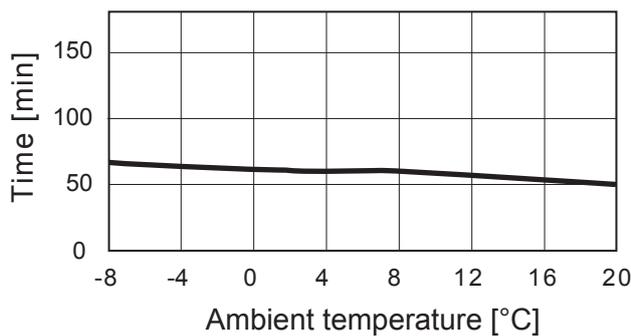

	Ambient temperature [°C]			
	-7	2	7	20
Heat time (min)	65	60	60	50

- Mitsubishi's domestic hot water tank (200 [L])
- Time to raise DHW tank temperature 15 – 55[°C]

Reheat time

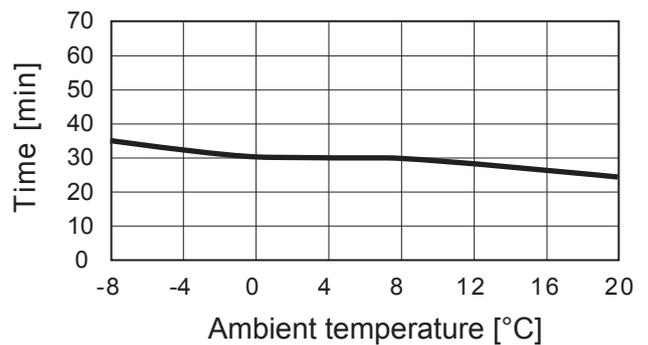

	Ambient temperature [°C]			
	-7	2	7	20
Reheat time (min)	35	30	30	25

- Mitsubishi's domestic hot water tank (200 [L])
- Time to reheat 50%(100 [L]) of DHW tank to 55 [°C]

■ PUAZ-SHW140YHA(-BS)

Heat time

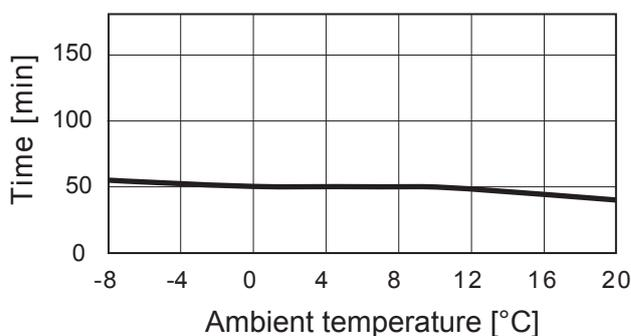

	Ambient temperature [°C]			
	-7	2	7	20
Heat time (min)	55	50	50	40

- Mitsubishi's domestic hot water tank (200 [L])
- Time to raise DHW tank temperature 15 – 55[°C]

Reheat time

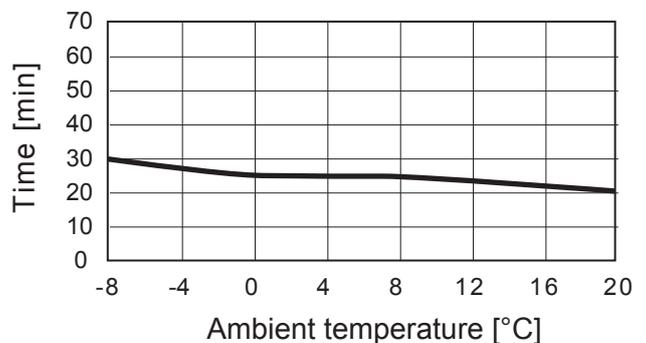

	Ambient temperature [°C]			
	-7	2	7	20
Reheat time (min)	30	25	25	20

- Mitsubishi's domestic hot water tank (200 [L])
- Time to reheat 50%(100 [L]) of DHW tank to 55 [°C]

■ PUAZ-SHW80VAA/YAA(-BS)

Heat time

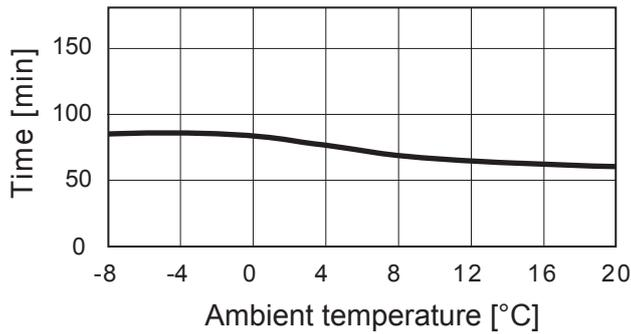

- Mitsubishi's domestic hot water tank (200 [L])
- Time to raise DHW tank temperature 15 – 55[°C]

Reheat time

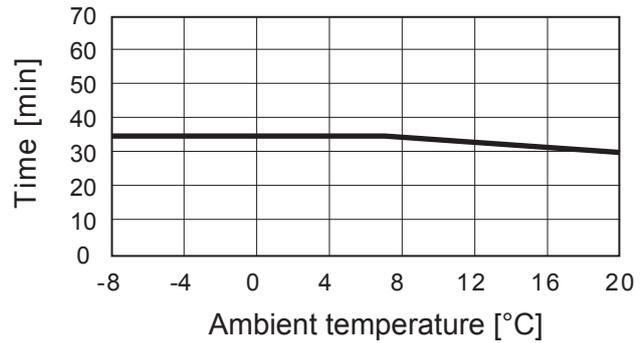

- Mitsubishi's domestic hot water tank (200 [L])
- Time to reheat 50%(100 [L]) of DHW tank to 55 [°C]

■ PUAZ-SHW112VAA/YAA(-BS)

Heat time

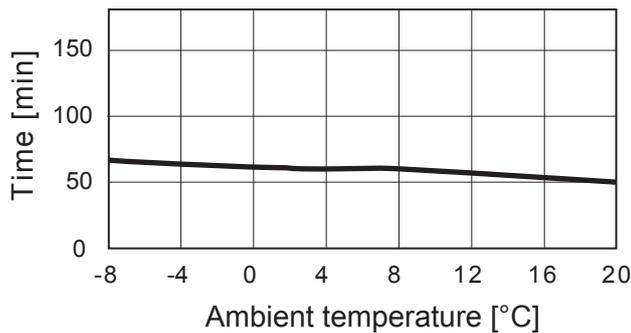

- Mitsubishi's domestic hot water tank (200 [L])
- Time to raise DHW tank temperature 15 – 55[°C]

Reheat time

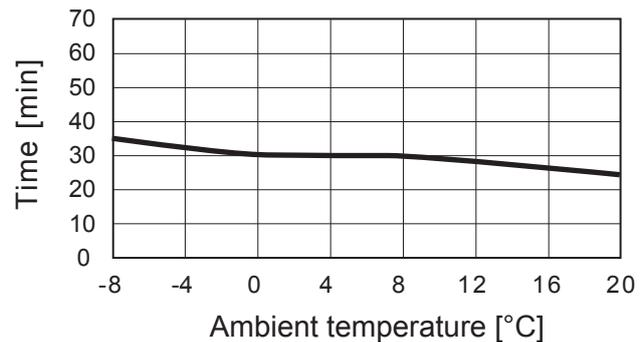

- Mitsubishi's domestic hot water tank (200 [L])
- Time to reheat 50%(100 [L]) of DHW tank to 55 [°C]

■ PUMY-P112/125/140V/YKM(E)4(-BS)

Heat time

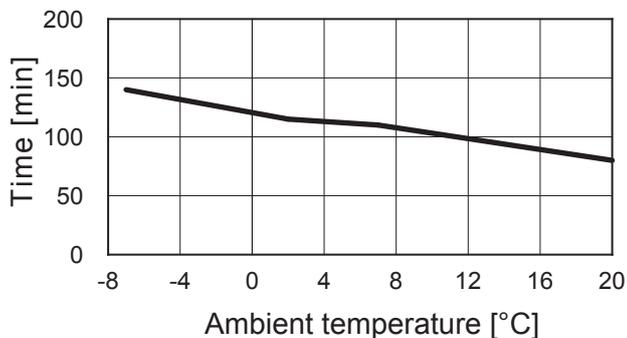

- Mitsubishi's domestic hot water tank (200 [L])
- Time to raise DHW tank temperature 15 – 55 [°C]

Reheat time

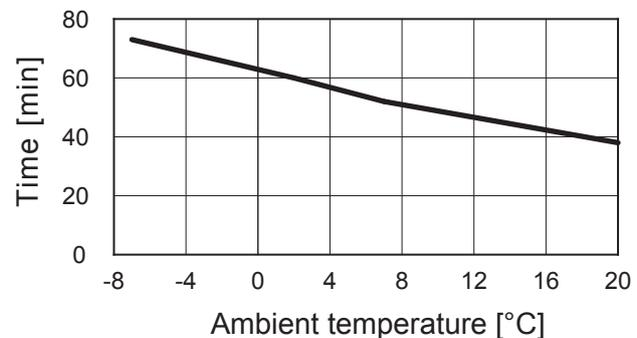

- Mitsubishi's domestic hot water tank (200 [L])
- Time to reheat 50% (100 [L]) of DHW tank to 55 [°C]

■ Cylinder unit <E**T20*.*M**C>

Pump speed (primary circuit): 5
 Pump speed (sanitary circuit): 2
 Flow rate: 20L/min
 SPL: 28dB

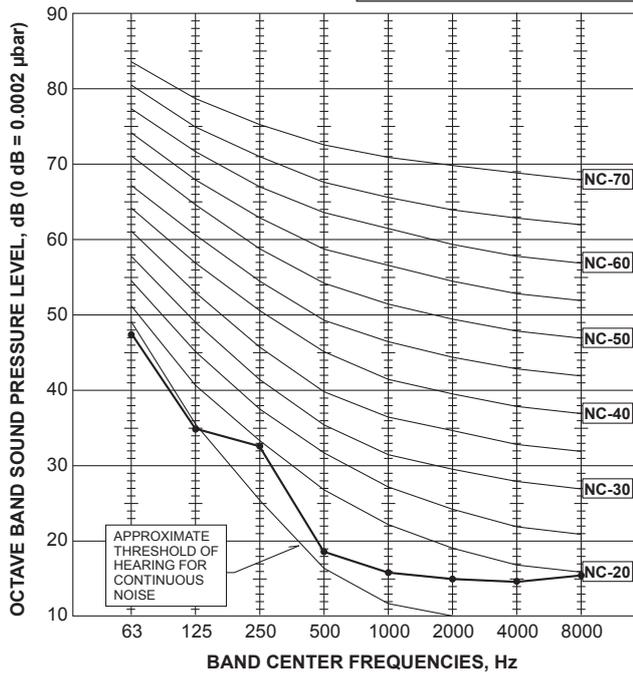

■ Hydrobox <E*SC/D> <EHPX>

Pump speed: 5
 Flow rate: 20L/min
 SPL: 28dB

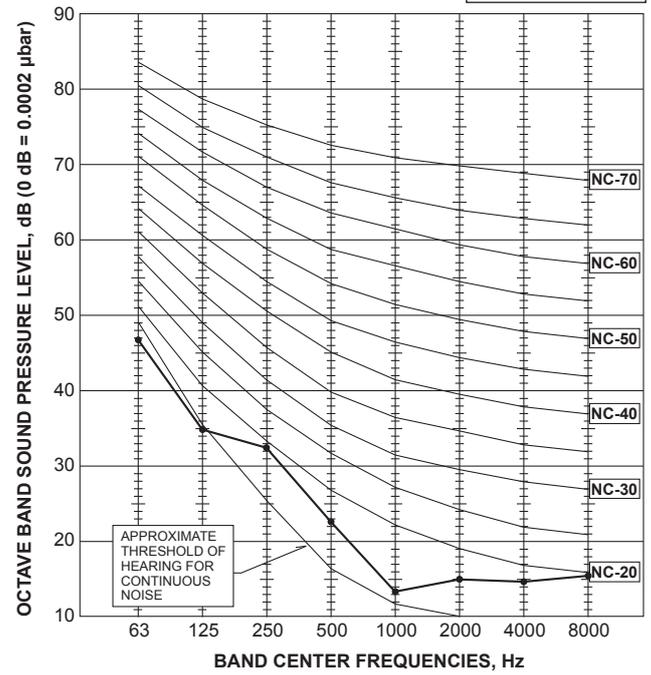

■ Large Hydrobox <E*SE>

Pump speed: 5
 Flow rate: 44L/min
 SPL: 30dB

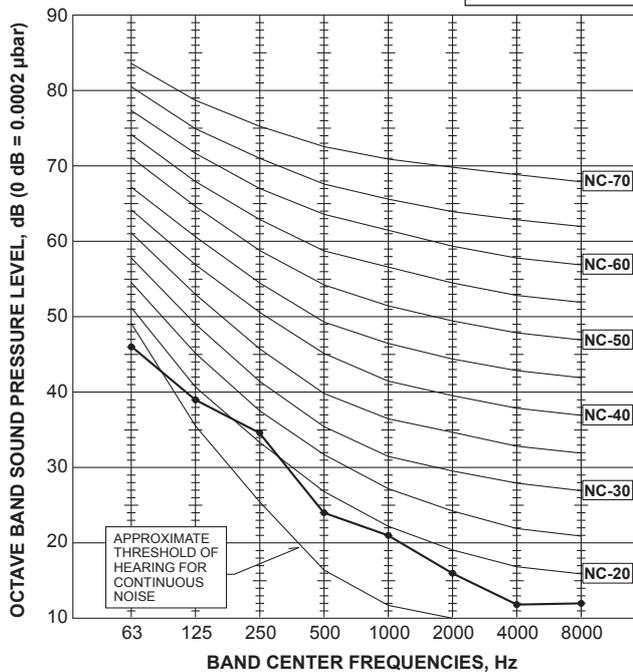

■ Cylinder unit

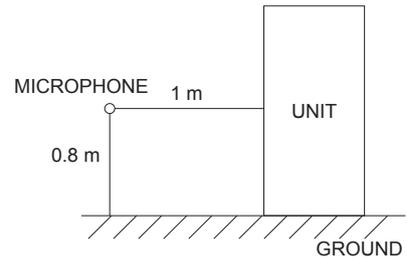

■ Hydrobox

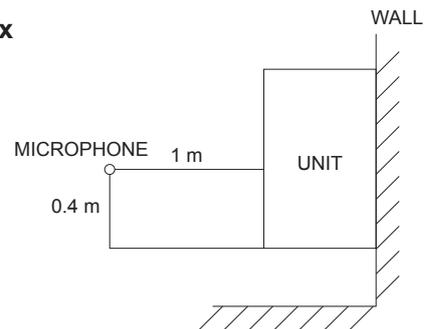

■ Large Hydrobox

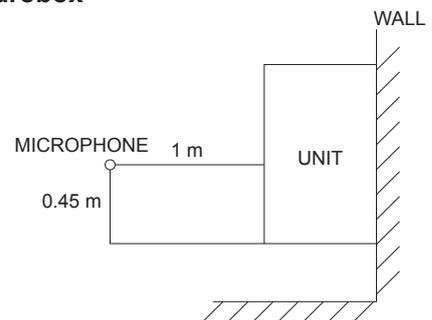

■ Main remote controller

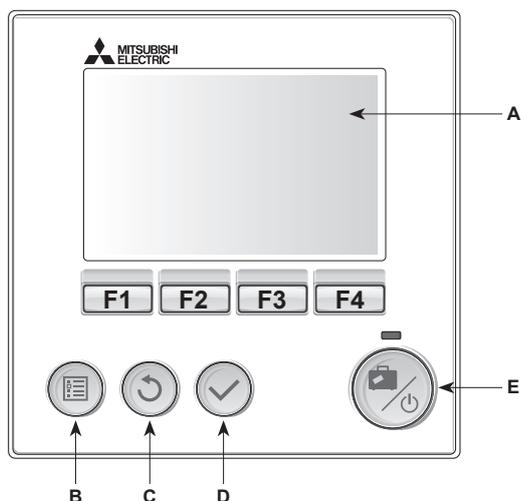

<Main remote controller parts>

Letter	Name	Function
A	Screen	Screen in which all information is displayed
B	Menu	Access to system settings for initial set up and modifications.
C	Back	Return to previous menu.
D	Confirm	Used to select or save. (Enter key)
E	Power/Holiday	If system is switched off pressing once will turn system on. Pressing again when system is switched on will enable Holiday Mode. Holding the button down for 3 seconds will turn the system off. (*1)
F1-4	Function keys	Used to scroll through menu and adjust settings. Function is determined by the menu screen visible on screen A.

*1

When the system is switched off or the power supply is disconnected, the cylinder unit/hydrobox protection functions (e.g. freeze stat function) will NOT operate. Please beware that without these safety functions enabled the cylinder unit/hydrobox may potentially become exposed to damage.

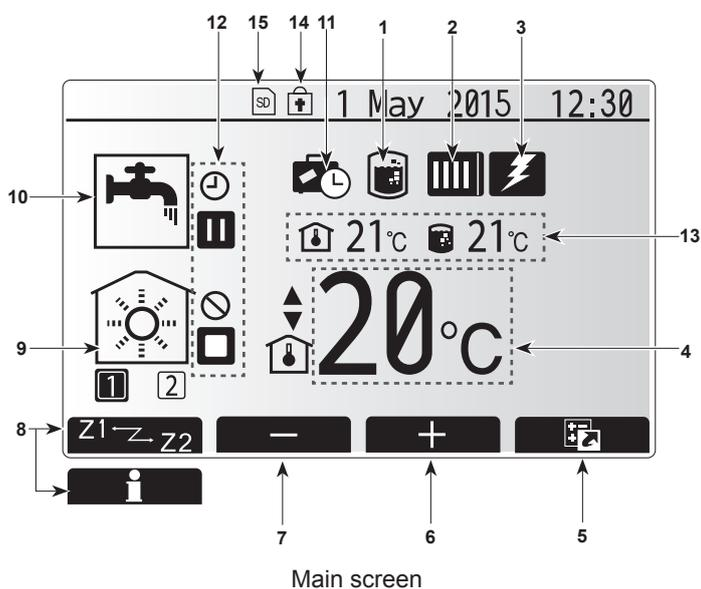

<Main screen icons>

	Icon	Description
1	Legionella prevention icon	When this icon is displayed 'Legionella prevention mode' is active.
2	Heat pump icons	'Heat pump' is running.
		Defrosting
		Emergency heating
3	Electric heater icon	When this icon is displayed the 'Electric heaters' (booster or immersion heater) are in use.
4	Target temperature icons	Target flow temperature
		Target room temperature
		Compensation curve
5	OPTION	Pressing the function button below this icon will display the option screen.
6	+	Increase desired temperature.
7	-	Decrease desired temperature.
8	Z1 Z2	Pressing the function button below this icon switches between Zone1 and Zone2.
	Information icon	Pressing the function button below this icon displays the information screen.
9	Space heating/cooling mode icons	Heating mode Zone1 or Zone2
		Cooling mode Zone1 or Zone2
10	DHW mode icon	Normal or ECO mode
11	Holiday mode icon	When this icon is displayed 'Holiday mode' activated.
12	Status icons	Timer
		Prohibited
		Server control
		Stand-by
		Stand-by (*2)
		Operating
13	Current temperature icons	Current room temperature
		Current water temperature of DHW tank
14	Lock icon	The Menu button is locked or the switching of the operation modes between DHW and Heating operations are disabled in the Option screen. (*3)
15	SD card icons	SD memory card is inserted. Normal operation.
		SD memory card is inserted. Abnormal operation.

*2 This unit is in Stand-by whilst other indoor unit(s) is in operation by priority.

*3 To lock or unlock the Menu, press the BACK and CONFIRM keys simultaneously for 3 seconds.

■ Setting the Main remote controller

After the power has been connected to the outdoor and hydrobox (See chapter 3.1.4 (cylinder) or 3.2.4 (hydrobox)) the initial system settings can be entered via the main remote controller.

1. Check all breakers and other safety devices are correctly installed and turn on power to the system.
2. When the main remote controller switched on for the first time, the screen automatically goes to Initial settings menu, Language setting screen and Date/Time setting screen in order.
3. Main remote controller will automatically start up. Wait approximately 6 minutes whilst the control menus load.
4. When the controller is ready a blank screen with a line running across the top will be displayed.
5. Press button E (Power) (refer to page B-76) to turn on the system. Before turning on the system, perform initial settings as instructed below.

■ Main Settings Menu

The main settings menu can be accessed by pressing the MENU button. To reduce the risk of untrained end users altering the settings accidentally there are 2 access levels to the main settings; and the service section menu is password protected.

User Level – Short press

If the MENU button is pressed once for a short time the main settings will be displayed but without the edit function. This will enable the user to view current settings but **NOT** change the parameters.

Installer Level – Long press

If the MENU button is pressed down for 3 seconds the main settings will be displayed with all functionality available. The color of ◀▶ buttons is inverted as per right figure.

The following items can be viewed and/or edited (dependent on access level).

- Domestic Hot water (DHW)
- Heating/Cooling
- Schedule timer
- Holiday mode
- Initial settings
- Service (Password protected)

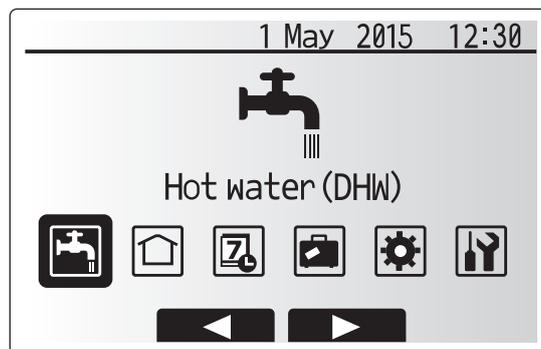

Main menu

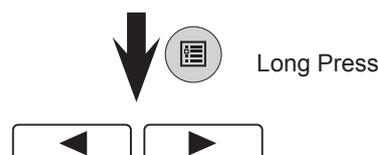

General Operation

- To find the icon that you wish to set, use the F2 and F3 buttons to move between the icons.
- The highlighted icon will appear as a larger version of the center of the screen.
- Press CONFIRM to select and edit the highlighted mode.
- Follow the <Main remote controller Menu Tree> for further setting, using ◀▶ buttons for scrolling or F1 to F4 for selecting.

<Main remote controller Menu Tree>

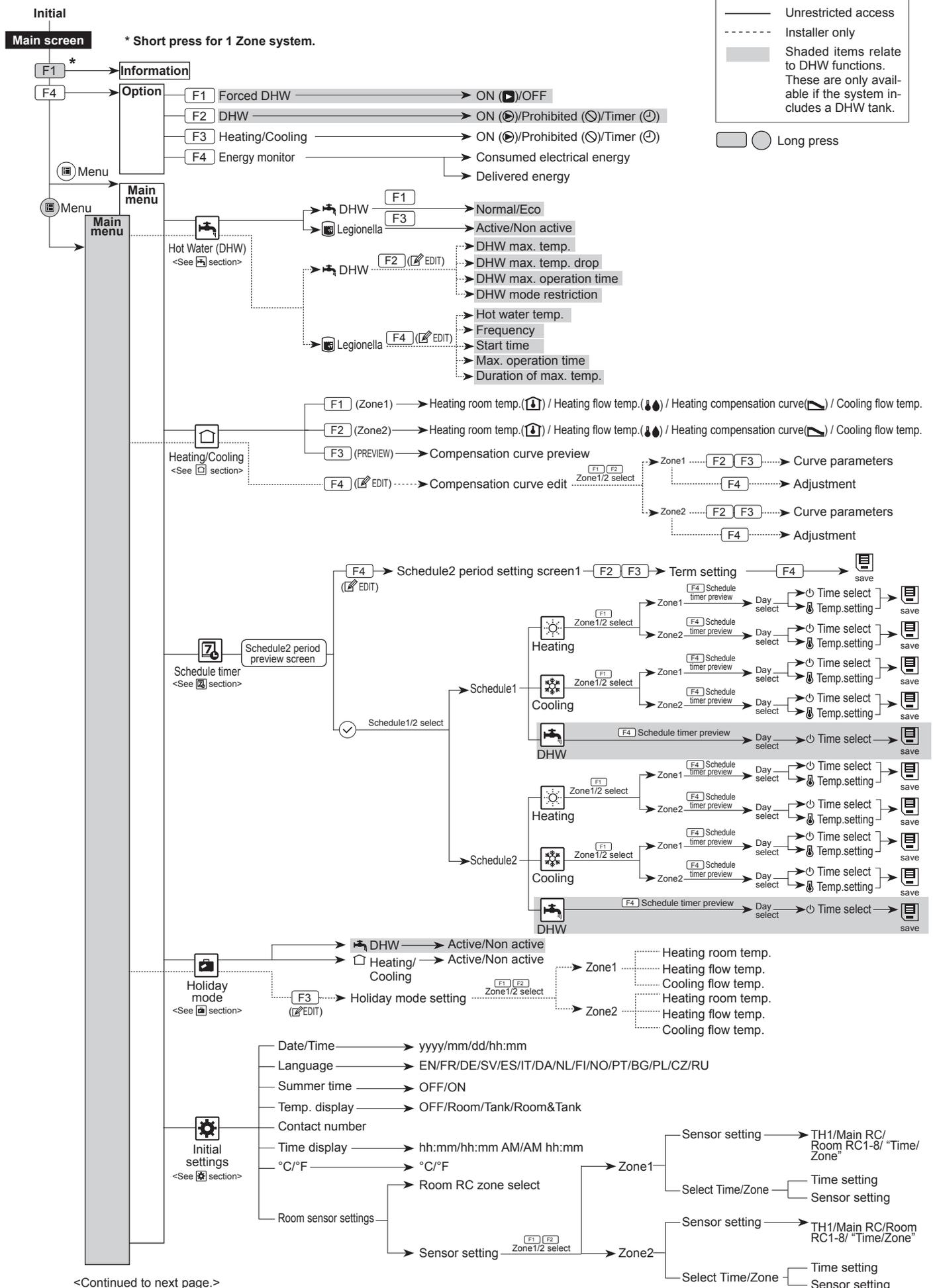

- Unrestricted access
- - - - - Installer only
- Shaded items relate to DHW functions. These are only available if the system includes a DHW tank.
- ⬤ ○ Long press

Cylinder / Hydrobox

<Continued to next page.>

<Main remote controller Menu Tree>

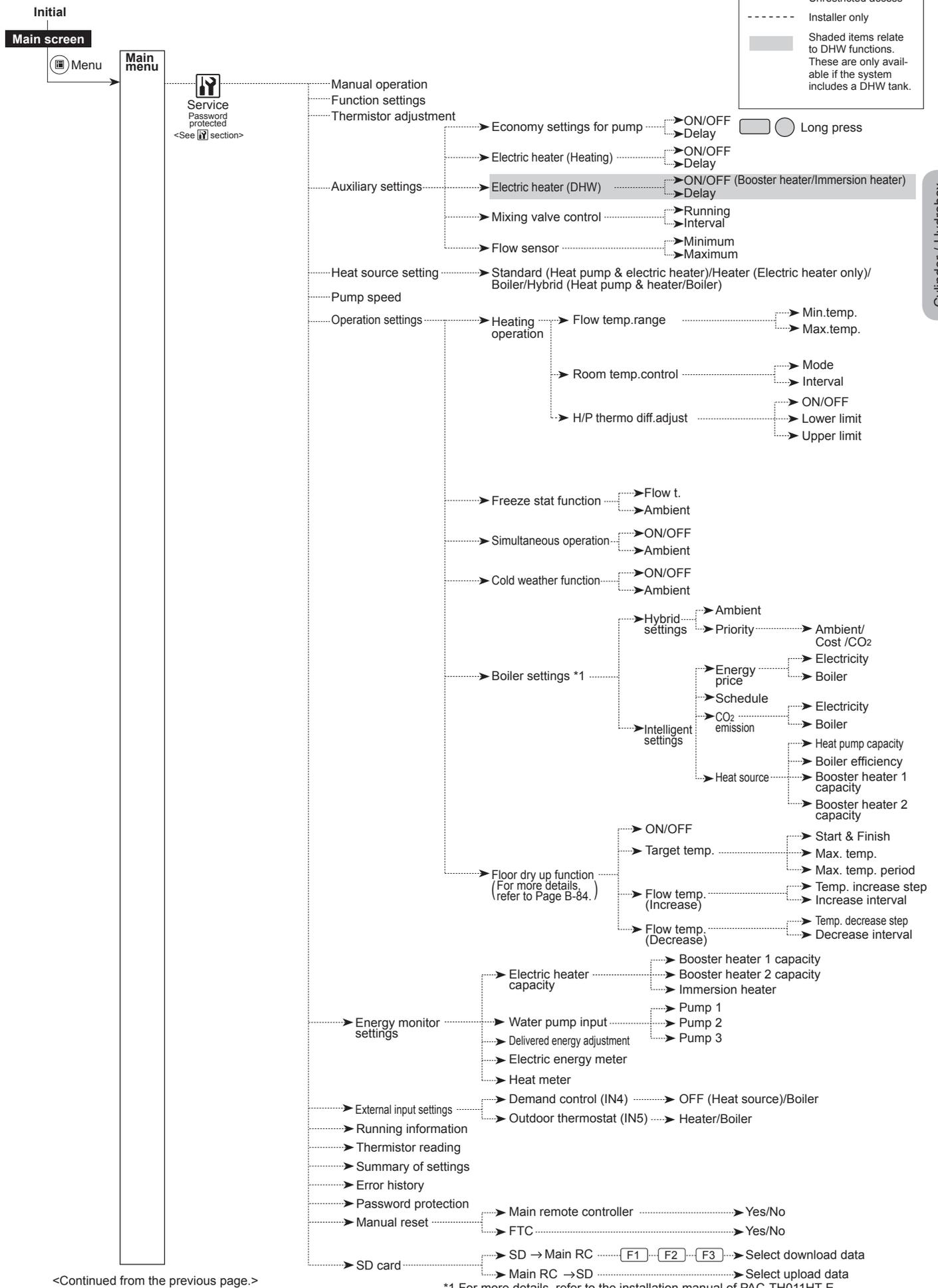

<Continued from the previous page.>

*1 For more details, refer to the installation manual of PAC-TH011HT-E.

Domestic Hot Water (DHW)/Legionella Prevention

► For further detail about operation, refer to Operation manual.

Please note that LP mode uses the assistance of electric heaters (if present) to supplement the energy input of the heat pump. Heating water for long periods of time is not efficient and will increase running costs. The installer should give careful consideration to the necessity of legionella prevention treatment whilst not wasting energy by heating the stored water for excessive time periods. The end user should understand the importance of this feature.
ALWAYS COMPLY WITH LOCAL AND NATIONAL GUIDANCE FOR YOUR COUNTRY REGARDING LEGIONELLA PREVENTION.

Heating/Cooling

► For further detail about operation, refer to Operation manual.

Schedule timer

Scheduled timer can be set in two ways, for example; one for summer and the other for winter. (Refer to as "Schedule 1" and "Schedule 2" respectively.) Once the term (months) for the Schedule 1 is specified, rest of the term will be specified as Schedule 2. In each Schedule, an operational pattern of modes (Heating / DHW) can be set. If no operational pattern is set for Schedule2, only the pattern for Schedule 1 will be valid. If Schedule 2 is set to full-year (i.e. March to Feb.), only the operational pattern for Schedule 2 will be valid.

Follow the procedure described in General Operation (Page B-77) for the set up operation.

Setting the schedule timer

The preview screen allows you to view the current settings. In 2-zone heating operation, press F1 to switch between Zone1 and Zone2. Days of the week are displayed across the top of the screen. Where day appears underlined the settings are the same for all those days underlined.

Hours of the day and night are represented as a bar across the main part of the screen. Where the bar is solid black, space heating/cooling and DHW (whichever is selected) is allowed.

When scheduling heating, button F1 changes the scheduled variable between time and temperature. This enables a lower temperature to be set for a number of hours e.g. a lower temperature may be required at night when the occupants are sleeping.

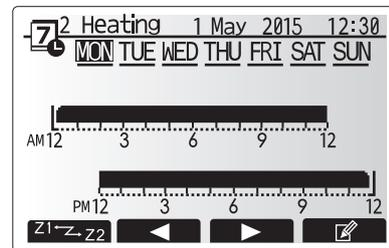

Preview screen

- The schedule timer for space heating/cooling and DHW are set in the same way. However for DHW only time can be used as scheduling variable.
- A small rubbish bin character is also displayed choosing this icon will delete the last unsaved action.
- It is necessary to use the SAVE function F4 button to save settings. CONFIRM does not act as SAVE for this menu.

Holiday mode

► For further detail about operation, refer to Operation manual.

Initial Settings

From the Initial settings menu the installer can set the following.

- Date/Time *Be sure to set it to the local standard time.
- Language
- Summer time
- Temp. display
- Contact number
- Time display
- °C/°F
- Room sensor settings

Follow the procedure described in General Operation for the set up operation.

<Room sensor settings>

For room sensor settings it is important to choose the correct room sensor depending on the heating mode the system will operate in.

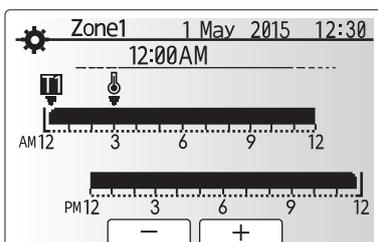

Time/Zone schedule setting screen

Menu subtitle	Description		
Room RC zone select	When 2-zone temperature control is active and wireless remote controllers are available, from Room RC zone select screen, select zone no. to assign to each remote controller.		
Sensor setting	From sensor setting screen, select a room sensor to be used for monitoring the room temperature from Zone1 and Zone2 separately.		
	Control option ('Main remote controller options' in Installation Manual)	Corresponding initial settings room sensor	
		Zone 1	Zone 2
	A	Room RC 1-8 (one each for Zone1 and Zone2)	*1
	B	TH1	*1
	C	Main remote controller	*1
	D	*1	*1
	When different room sensors are used according to the time schedule	Time/ Zone*2	*1
<p>*1. Not specified (if a locally-supplied room thermostat is used) Room RC 1-8 (one each for Zone1 and Zone2) (if a wireless remote controller is used as a room thermostat)</p> <p>*2. From sensor setting screen, select Time/Zone to make it possible to use different room sensors according to the time schedule set in the Select Time/ Zone menu. The room sensors can be switched up to 4 times within 24 hours.</p>			

Service Menu

The service menu provides functions for use by installer or service engineer. It is NOT intended the home owner alters settings within this menu. It is for this reason password protection is required to prevent unauthorised access to the service settings.

The factory default password is "0000".

Follow the procedure described in General Operation for the set up operation.

The service menu is navigated using the F1 and F2 buttons to scroll through the functions. The menu is split across two screens and is comprised of the following functions;

1. Manual operation
2. Function settings
3. Thermistor adjustment
4. Auxiliary settings
5. Heat source setting
6. Pump speed
7. Operation settings
8. Energy monitor settings
9. External input settings
10. Running information
11. Thermistor reading
12. Summary of settings
13. Error history
14. Password protection
15. Manual reset
16. SD card

Many functions can not be set whilst the indoor unit is running. The installer should turn off the unit before trying to set these functions. If the installer attempts to change the settings whilst the unit is running the main remote controller will display a reminder message prompting the installer to stop operation before continuing. By selecting "Yes" the unit will cease operation.

<Manual operation>

During the filling of the system the water circulation pump and 3-way valve can be manually overridden using manual operation mode.

When manual operation is selected a small timer icon appears in the screen. The function selected will only remain in manual operation for a maximum of 2 hours. This is to prevent accidental permanent override of the FTC.

► Example

Pressing F3 button will switch manual operation mode ON for the main 3-way valve. When filling of the DHW tank is complete the installer should access this menu again and press F3 to deactivate manual operation of the part.

Alternatively after 2 hours manual operation mode will no longer be active and FTC will resume control of the part.

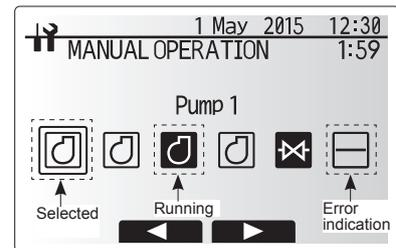

Manual operation menu screen

Manual operation and heat source setting can not be selected if the system is running. A screen will be displayed asking the installer to stop the system before these modes can be activated. The system automatically stops 2 hours after last operation.

<Function settings>

Function Setting allows the setting of auto recovery after power failure and of smart grid ready.

1. From the service menu use F1 and F2 to highlight Function Setting.
2. Press CONFIRM.
3. Ensure the Ref address and unit number are displayed to the right.
4. Press CONFIRM.
5. Use F3 and F4 to highlight either 1/2/3 (see below).
6. Press CONFIRM.

Setting	Unit	Mode	Number
Auto recovery after power failure	Grp	Mode1	1 - Inactive 2 - Active *1 3 - NO FUNCTION
Smart grid ready *2 (Hot water operation)	1	Mode7 *3	1 - Inactive 2 - Target temp. +3°C 3 - Target temp. +5°C
Smart grid ready *2 (Heating operation)	1	Mode8 *3	1 - Inactive 2 - Thermo ON temp. +2°C 3 - Thermo ON temp. +3°C

*1 Approx. 4-minute delay after power is restored.

*2 Refer to "Smart grid ready" in the indoor unit installation manual.

*3 If the mode is not displayed, Function Setting must be initialised. Enter Request code "200" in "Running Information".

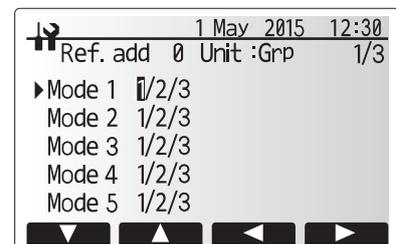
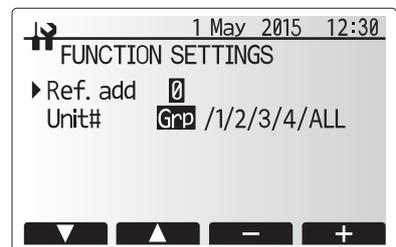

<Thermistor adjustment>

This function allows adjustments to be made to the thermistor readings from -10 – 10 °C in 0.5 °C intervals.

- THW1: Thermistor (Flow water temp.)
- THW2: Thermistor (Return water temp.)
- THW5: Thermistor (DHW tank water temp.)
- THW6: Thermistor (Zone1 flow temp.)(Option)
- THW7: Thermistor (Zone1 return temp.)(Option)
- THW8: Thermistor (Zone2 flow temp.)(Option)
- THW9: Thermistor (Zone2 return temp.)(Option)
- THWB1: Thermistor (Boiler flow temp.)(Option)
- THWB2: Thermistor (Boiler return temp.)(Option)

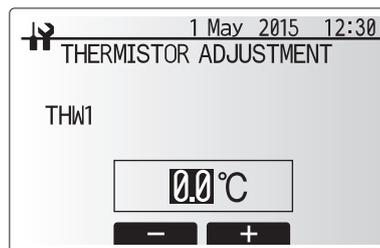

<Auxiliary settings>

This function is used to set the parameters for any auxiliary parts used in the system

Menu subtitle	Function/ Description
Economy settings for pump	Water pump stops automatically in certain period of time from when operation is finished.
Delay	Time before pump switched off*1
Electric heater (Heating)	To select "WITH booster heater (ON)" or "WITHOUT booster heater (OFF)" in Heating mode.
Delay	The minimum time required for the booster heater to turn ON from after Heating mode has started.
Electric heater (DHW)	To select "WITH (ON)" or "WITHOUT (OFF)" booster heater or immersion heater individually in DHW mode.
Delay	The minimum time required for the booster heater or immersion heater to turn ON from after DHW mode has started. (This setting is applied for both booster and immersion heater.)
Mixing valve control *2	Period from valve fully open (at a hot water mixing ratio of 100%) to valve fully closed (at a cold water mixing ratio of 100%)
Interval	Interval (min) to control the Mixing valve.
Flow sensor *3	The minimum flow rate to be detected at Flow sensor.
Maximum	The maximum flow rate to be detected at Flow sensor.

- *1. Decreasing "time before pump switched off" may increase the duration of stand-by in Heating/Cooling mode.
- *2. Set the Running time according to the specifications of the actuator of each mixing valve. It is recommended to set the interval to 2 minutes that is a default value. With the interval set longer, it could take longer to warm up a room.
- *3. Do not change the setting since it is set according to the specification of Flow sensor attached to the hydrobox.

Economy settings for pump

1. From the Auxiliary settings menu highlight Economy Settings for water circulation pump.
2. Press CONFIRM.
3. The economy settings for water circulation pump screen is displayed.
4. Use button F1 to switch the economy settings ON/OFF.
5. Use buttons F3 and F4 to adjust the time the water circulation pump will run. (3 - 60 minutes)

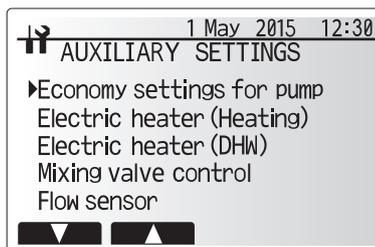

Auxiliary settings menu screen

Electric heater (Heating)

1. From the Auxiliary settings menu highlight Electric heater (Heating).
2. Press CONFIRM.
3. The Electric heater (Heating) screen is displayed.
4. Press F1 button to switch the function ON/OFF.
5. Use F3 and F4 buttons to adjust the time period of heat pump only operation before the booster heater will assist in space heating. (5 -180minutes)

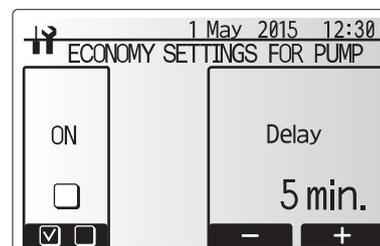

Economy settings for pump screen

Electric heater (DHW)

1. From the Auxiliary settings menu highlight Electric heater (DHW).
2. Press CONFIRM.
3. The Electric heater (DHW) screen is displayed.
4. Press F1 button to switch the function ON/OFF.
5. Use F3 and F4 buttons to adjust the time period of heat pump only operation before the booster heater and the immersion heater (if present) will assist in DHW heating. (15 -30minutes)

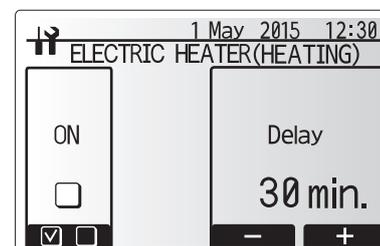

Electric heater (Heating) screen

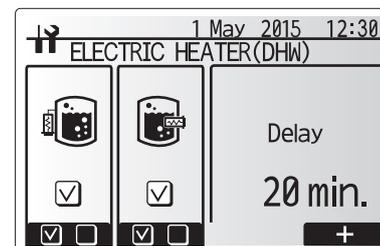

Electric heater (DHW) screen

Mixing valve control

1. From the Auxiliary settings menu highlight Mixing valve control.
2. Press CONFIRM.
3. The Mixing valve control screen is displayed.
4. Use F1 and F2 buttons to set Running time between 10 to 240 seconds. The Running time equals to a period from full open of the valve (at a hot water mixing ratio of 100%) to full close (at a cold water mixing ratio of 100%).

Note: Set the Running time according to the specifications of the actuator of each mixing valve.

1. From the Auxiliary settings menu highlight Mixing valve control.
2. Press CONFIRM.
3. The Mixing valve control screen is displayed.
4. Press F3 and F4 buttons to set the interval between 2-zone temperature controls of the mixing valve between 1 to 30 minutes.

Note: It is recommended to set the interval to 2 minutes that is a default value. With the interval set longer, it could take longer to warm up a room.



Mixing valve setting screen

Flow sensor

1. From the Auxiliary settings menu highlight Flow sensor.
2. Press CONFIRM.
3. Press F3 or F4 buttons to select a refrigerant address of which you wish to configure or check the settings, and press CONFIRM. *1.
4. The Flow sensor screen is displayed.
5. Use F1 and F2 buttons to set the minimum flow rate of flow sensor between 0 to maximum L/min.
6. Use F1 and F2 buttons to set the maximum flow rate of flow sensor between minimum to 100L/min.

*1 For multiple outdoor units control system only.

Note: Do not change the setting since it is set according to the specification of Flow sensor attached to the hydrobox.

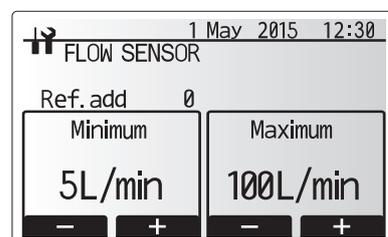

Flow sensor setting screen

<Heat source setting>

The default heat source setting is heat pump and all electric heaters present in the system to be operational. This is referred to as Standard operation on the menu.



Heat source setting screen

<Pump speed>

1. From the Service menu highlight water pump speed.
2. Press CONFIRM.
3. Press F3 and F4 buttons to select a refrigerant address of which you wish to configure or check the settings, and press CONFIRM. *1
4. The Pump speed screen is displayed.
5. Use F2 and F3 buttons to set the pump speed of the water circulation pump between 1 and 5.

*1 For multiple outdoor units control system only.

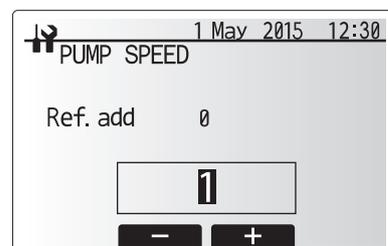

Pump speed setting screen

<Operation settings>

Heating operation

This function allows operational setting of flow temperature range from the Ecodan and also the time interval at which the FTC collects and processes data for the auto adaptation mode.

Menu subtitle	Function	Range	Unit	Default	
Flow temp. range	Minimum temp.	To minimize the loss by frequent ON and OFF in mild outdoor ambient temperature seasons.	25 - 45	°C	30
	Maximum temp.	To set max. possible flow temperature according to the type of heat emitters.	35 - 60	°C	50
Room temp. control	Mode	Setting for Room temp. control At Fast mode, target outlet water temperature is set higher than the one set at normal mode. This reduces the time to reach the target room temperature when the room temperature is relatively low.*	Normal/ Fast	—	Normal
	Interval	Selectable according to the heat emitter type and the materials of floor (i.e. radiators, floor heating-thick, -thin concrete, wood, etc.)	10 - 60	minutes	10
Heat pump thermo diff.adjust	On/Off	To minimize the loss by frequent ON and OFF in mild outdoor ambient temperature seasons.	On/Off	—	On
	Lower limit	Prohibits heat pump operation until the flow temperature drops below the target flow temperature plus lower limit value.	-9 - -1	°C	-5
	Upper limit	Allows heat pump operation until the flow temperature rises above the target flow temperature plus upper limit value.	+3 - +5	°C	+5

< Heating operation (Room temp. control table) >

Note:

- The minimum flow temperature that prohibits heat pump operation is 20°C.
When the cylinder unit/hydrobox is connected with a PUMY outdoor unit; To conduct a simultaneous operation of ATA heating and ATW space heating, set the minimum flow temperature above 45°C.
 - The maximum flow temperature that allows heat pump operation equals to the maximum temperature set in the Flow temp. range menu.
- * Fast mode is not efficient and will increase running cost compared to normal mode.

Freeze stat function

Menu subtitle	Function/ Description
Freeze stat function*1	An operational function to prevent the water circuit from freezing when outdoor ambient temperature drops.
Flow t.	The target outlet water temperature at water circuit when operating in Freeze stat function. *2
Outdoor ambient temp.	Minimum outdoor ambient temperature which freeze stat function will begin to operate, (3 - 20°C) or choose**. If asterisk (**) is chosen freeze stat function is deactivated. (i.e. primary water freeze risk)"

*1. When the system is turned off, freeze stat function is not enabled.

*2. Flow t. is fixed to 20°C and unchangeable.

Simultaneous Operation

For periods of very low outside temperature this mode can be used. Simultaneous operation allows both DHW and space heating to run together by using the heat pump and/or booster heater to provide space heating whilst only the immersion heater provides heating for DHW. This operation is only available if BOTH a DHW tank AND immersion heater are present on the system.

- Range of outdoor ambient temperature at which simultaneous operation starts is -30°C to 10°C (default -15°C).
- System shall automatically return to routine operation. This will happen when the outdoor ambient temperature rises above the selected temperature for this specific mode of operation.

Cold weather function

For extremely low outdoor ambient temperature conditions when the heat pump's capacity is restricted the heating or DHW is provided only by the electric booster heater (and immersion if present). This function is intended for use during extreme cold periods only. Extensive use of direct electrical heaters ONLY will result in higher power consumption and may reduce working life of heaters and related parts.

- Range of outdoor ambient temperature at which cold weather function starts is -30°C to -10°C (default -15°C).
- System shall automatically return to routine operation. This will happen when the outdoor ambient temperature rises above the selected temperature for this specific mode of operation.

Floor dry up function

The Floor dry up function automatically changes the target hot water temperature in stages to gradually dry concrete when this particular type of underfloor heating system is installed.

Upon completion of the operation the system stops all the operations except the Freeze stat.

For Floor dry up function, the target flow temp. of Zone 1 is the same as that of Zone 2.

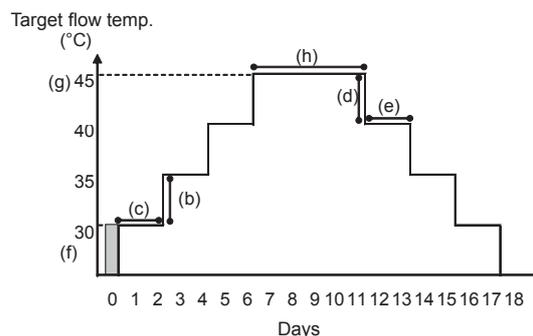

- This function is not available when a PUAHZ-FRP outdoor unit is connected.
- Disconnect wiring to external inputs of room thermostat, demand control, and outdoor thermostat, or the target flow temperature may not be maintained.

Functions	Symbol	Description	Option/Range	Unit	Default	
Floor dry up function	a	Sets the function to ON and power on the system using the main remote controller, and the dry up heating operation will start.	On/Off	—	Off	
Flow temp. (increase)	Flow temp. increase step	b	Sets the increase step of the target flow temperature.	+1 - +10	°C	+5
	Increase interval	c	Sets the period for which the same target flow temperature is maintained.	1 - 7	day	2
Flow temp. (decrease)	Flow temp. decrease step	d	Sets the decrease step of the target flow temperature.	-1 - -10	°C	-5
	Decrease interval	e	Sets the period for which the same target flow temperature is maintained.	1 - 7	day	2
Target temperature	Start & Finish	f	Sets the target flow temperature at the start and the finish of the operation.	25 - 60	°C	30
	Max. target temp.	g	Sets the maximum target flow temperature.	25 - 60	°C	45
	Max. temp. period	h	Sets the period for which the maximum target flow temperature is maintained.	1 - 20	day	5

<Energy monitor settings> (Except for EHSE/ERSE series)

1. General description

End user can monitor accumulated*1 'Consumed electrical energy' and 'Delivered heat energy' in each operation mode*2 on the main remote controller.

*1 Monthly and Year to date

*2 - DHW operation

- Space heating
- Space cooling

Refer to the menu tree on the page B-78 and B-79 for how to check the energy, and "3.1.2, 3.2.2 and 3.2.3 DIP switch setting" for the details on DIP-SW setting. Either one of the following two method is used for monitoring.

Note: Method 1 should be used as a guide. If a certain accuracy is required, the 2nd method should be used.

(1) Calculation internally

Electricity consumption is calculated internally based on the energy consumption of outdoor unit, electric heater, water pump(s) and other auxiliaries.(*3)

Delivered heat is calculated internally by multiplying delta T (Flow and Return temp.) and flow rate measured by the factory fitted sensors.

Set the electric heater capacity and water pump(s) input according to indoor unit model and specs of additional pump(s) supplied locally. (Refer to the menu tree on the page B-78 and B-79.)

<Cylinder unit>

	Booster heater 1	Booster heater 2	Immersion heater *1	Pump 1 *2	Pump 2	Pump 3
Default	2kW	4kW	0kW	*** (factory fitted pump)	0kW	0kW
EHST20C-VM2C	2kW	0kW	0kW	***	When additional pumps supplied locally are connected as Pump2/3, change setting according to specs of the pumps.	
EHST20C-VM6C	2kW	4kW	0kW	***		
EHST20C-YM9C	3kW	6kW	0kW	***		
EHST20C-TM9C	3kW	6kW	0kW	***		
EHST20C-VM2EC	2kW	0kW	0kW	***		
EHST20C-VM6EC	2kW	4kW	0kW	***		
EHST20C-YM9EC	3kW	6kW	0kW	***		
EHST20C-MEC	0kW	0kW	0kW	***		
EHST20D-VM2C	2kW	0kW	0kW	***		
EHST20D-MEC	0kW	0kW	0kW	***		
EHST20D-MHC	0kW	0kW	3kW	***		
EHST20D-VM2EC	2kW	0kW	0kW	***		
EHST20D-YM9C	3kW	6kW	0kW	***		
ERST20C-MEC	0kW	0kW	0kW	***		
ERST20C-VM2C	2kW	0kW	0kW	***		
ERST20D-MEC	0kW	0kW	0kW	***		
ERST20D-VM2C	2kW	0kW	0kW	***		
EHPT20X-VM2C	2kW	0kW	0kW	***		
EHPT20X-VM6C	2kW	4kW	0kW	***		
EHPT20X-YM9C	3kW	6kW	0kW	***		
EHPT20X-TM9C	3kW	6kW	0kW	***		
EHPT20X-MHCW	0kW	0kW	3kW	***		
EHST20C-MHCW	0kW	0kW	3kW	***		
EHST20D-MHCW	0kW	0kW	3kW	***		

<Hydrobox>

	Booster heater 1	Booster heater 2	Immersion heater *1	Pump 1 *2	Pump 2	Pump 3
Default	2kW	4kW	0kW	*** (factory fitted pump)	0kW	0kW
EHSD-MEC	0kW	0kW	0kW *1	***	When additional pumps supplied locally are connected as Pump2/3, change setting according to specs of the pumps.	
EHSD-MC	0kW	0kW	0kW *1	***		
EHSD-VM2C	2kW	0kW	0kW *1	***		
EHSD-YM9C	3kW	6kW	0kW *1	***		
EHSC-MEC	0kW	0kW	0kW *1	***		
EHSC-VM2C	2kW	0kW	0kW *1	***		
EHSC-VM2EC	2kW	0kW	0kW *1	***		
EHSC-VM6C	2kW	4kW	0kW *1	***		
EHSC-VM6EC	2kW	4kW	0kW *1	***		
EHSC-YM9C	3kW	6kW	0kW *1	***		
EHSC-YM9EC	3kW	6kW	0kW *1	***		
EHSC-TM9C	3kW	6kW	0kW *1	***		
ERSD-VM2C	2kW	0kW	0kW *1	***		
ERSC-MEC	0kW	0kW	0kW *1	***		
ERSC-VM2C	2kW	0kW	0kW *1	***		
EHPX-VM2C	2kW	0kW	0kW *1	***		
EHPX-VM6C	2kW	4kW	0kW *1	***		
EHPX-YM9C	3kW	6kW	0kW *1	***		

*1 Change setting to 3kW when connecting optional immersion heater "PAC-IH03V2-E".

*2 "****" displayed in the energy monitor setting mode means the factory fitted pump is connected as Pump 1 so that the input is automatically calculated.

*3 When the cylinder unit / hydrobox is connected with a PUHZ-FRP models, electricity consumption is not calculated internally. To display the electricity consumption, conduct the 2nd method.

When anti-freeze solution (propylene glycol) is used for primary water circuit, set the delivered energy adjustment if necessary. For further detail of above, refer to the menu tree on the page B-78 and B-79.

(2) Actual measurement by external meter (locally supplied)

FTC has external input terminals for 2 'Electric energy meters' and a 'Heat meter'.

If two 'Electric energy meters' are connected, the 2 recorded values will be combined at the FTC and shown on the main remote controller.

(e.g. Meter 1 for H/P power line, Meter 2 for heater power line)

Refer to the [Signal inputs] in section "3.1.1 and 3.2.1 Wiring diagrams" for more information on connectable electric energy meter and heat meter.

• Connectable electric energy meter and heat meter

- Pulse meter type Voltage free contact for 12VDC detection by FTC (TBI.3 1, 3 and 5 pin have a positive voltage.)
- Pulse duration Minimum ON time: 40ms
Minimum OFF time: 100ms
- Possible unit of pulse 0.1 pulse/kWh 1 pulse/kWh 10 pulse/kWh
100 pulse/kWh 1000 pulse/kWh

Those values can be set by the main remote controller. (Refer to the menu tree on the page B-78 and B-79.)

<Energy monitor settings> (EHSE/ERSE series)

End user can monitor accumulated*1 'Consumed electrical energy' and 'Delivered heat energy' in each operation mode*2 on the main remote controller.

*1 Monthly and Year to date

*2 - DHW operation

- Space heating
- Space cooling

Refer to the menu tree on the page B-78 and B-79 for how to check the energy, and "3.2.3 DIP switch functions" for the details on DIP-SW setting.

Either one of the following two method is used for monitoring.

Note: Method 1 should be used as a guide. If a certain accuracy is required, the 2nd method should be used.

1. Calculation internally

Electricity consumption is calculated internally based on the energy consumption of outdoor unit, electric heater, water pump(s) and other auxiliaries.

Delivered heat is calculated internally by multiplying delta T (Flow and Return temp.) and flow rate measured by the factory fitted sensors.

Set the electric heater capacity and water pump(s) input according to indoor unit model and specs of additional pump(s) supplied locally. (Refer to the menu tree in on the page B-78 and B-79)

	Booster heater 1	Booster heater 2	Immersion heater *2	Pump 1	Pump 2	Pump 3
Default *1	2 kW	4 kW	0 kW	***	0 W	0 W
ERSE-YM9EC	3 kW	6 kW	0 kW *2	*3	When additional pumps supplied locally are connected as Pump2/3, change setting according to specs of the pumps.	
ERSE-MEC	0 kW	0 kW	0 kW *2	*3		
EHSE-YM9EC	3 kW	6 kW	0 kW *2	*3		
EHSE-MEC	0 kW	0 kW	0 kW *2	*3		

<Table 7.1>

Pump speed	Pump 1
Speed 5 (Default setting)	180 W
Speed 4	172 W
Speed 3	113 W
Speed 2	70 W
Speed 1	38 W

<Table 7.2>

*1 Default setting is used for E*SC(D)/EHPX models. Please change setting according to <Table 6.1>.

*2 Change setting to 3kW when connecting optional immersion heater "PAC-IH03V2-E".

*3 Please change setting according to <Table 6.2>.

When anti-freeze solution (propylene glycol) is used for primary water circuit, set the delivered energy adjustment if necessary.

For further detail of above, refer to refer to the menu tree on the page B-78 and B-79.

2. Actual measurement by external meter (locally supplied)

FTC has external input terminals for 2 'Electric energy meters' and a 'Heat meter'.

If two 'Electric energy meters' are connected, the 2 recorded values will be combined at the FTC and shown on the main remote controller.

(e.g. Meter 1 for H/P power line, Meter 2 for heater power line)

Refer to the [Signal inputs] section in "3.2.4 Connecting inputs/outputs" for more information on connectable electric energy meter and heat meter.

2. Settings using the main remote controller

In this menu, all parameters required to record the consumed electrical energy and the delivered heat energy which is displayed on the main remote controller can be set. The parameters are an electric heater capacity, supply power of water pump and heat meter pulse.

Follow the procedure described in General Operation for the set up operation.

For Pump 1, *** can be also set besides this setting.

In the case *** is selected, the system acknowledges "factory fitted pump" is selected.

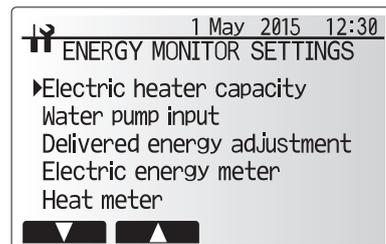

Energy monitor settings menu screen

<External input settings>

Demand control(IN4)

The selection of "OFF", whilst a signal is being sent to IN4, forcefully stops all the heat source operations and the selection of "Boiler" stops operations of heat pump and electric heater and performs boiler operation.

Outdoor thermostat (IN5)

The selection of "Heater", whilst a signal is being sent to IN5, performs electric-heater-only operation and the selection of "Boiler" performs boiler operation.

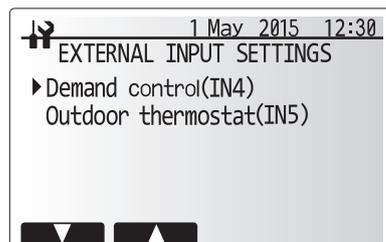

External input settings menu screen

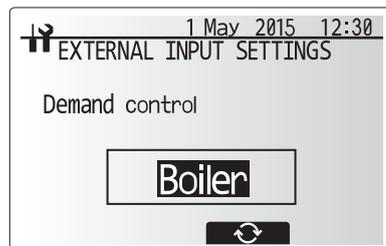

Demand control screen

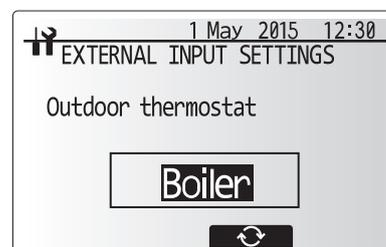

Outdoor thermostat setting screen

<Running information>

This function shows current temperature and other data of main component parts of both the indoor and outdoor units.

1. From the Service menu highlight Running information.
2. Press CONFIRM.
3. Press F3 and F4 buttons to set the Ref. address. *1
4. Use the function buttons to enter index code for the component to be viewed.
(See the Table 7.3 for component index codes.)
5. Press CONFIRM.

*1 For multiple outdoor units control system only.

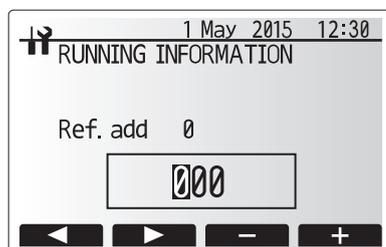

<Thermistor reading>

This function shows the current readings of thermistors located on the water and refrigerant circuit.

Thermistor	Description	Thermistor	Description
TH1A	Zone 1 room temperature	THW6	Zone 1 flow water temperature
TH1B	Zone 2 room temperature	THW7	Zone 1 return water temperature
TH2	Refrigerant return temperature	THW8	Zone 2 flow water temperature
THW1	Water flow temperature	THW9	Zone 2 return water temperature
THW2	Water return temperature	THWB1	Boiler flow water temperature
THW5	DHW tank water temperature	THWB2	Boiler return water temperature
TH7	Ambient (outdoor) temperature		

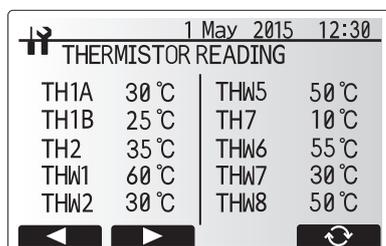

<Summary of settings>

This function shows the current installer/user entered settings.

Abbreviation	Explanation	Abbreviation	Explanation
HWtemp	DHW max. temperature	Z2 mode	Operation mode
HWdrop	DHW temperature drop		- HER (Heating room temperature)
HWtime	DHW max. operation time		- HE (Heating flow temperature)
NO HW	DHW mode restriction		- HCC (Heating compensation curve)
HWset	DHW operation mode (Normal/Eco)		- COR (—)
			- CO (Cooling flow temperature)
Ltemp	Legionella hot water temperature	Hroom 1	Heating target room temperature
Lfreq	Legionella operation Frequency	Hroom 2	Heating target room temperature
Lstart	Legionella mode start time	Hflow 1	Heating target flow temperature
Ltime	Legionella max. operation time	Hflow 2	Heating target flow temperature
Lkeep	Duration of max. (Legionella) hot water temperature	Croom 1	Cooling target room temperature
Z1 mode	Operation mode	Croom 2	Cooling target room temperature
	- HER (Heating room temperature)	Cflow 1	Cooling target flow temperature
	- HE (Heating flow temperature)	Cflow 2	Cooling target flow temperature
	- HCC (Heating compensation curve)	FSflow	Freeze stat function flow temperature
	- COR (—)	FSout	Freeze stat function ambient temperature
	- CO (Cooling flow temperature)		

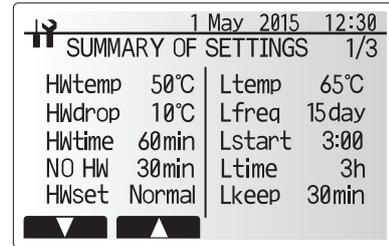

<Error history>

Error history allows the service engineer to view previous Error codes, the unit address and the date on which they occurred. Up to 16 Error codes can be stored in the history the most recent Error event is displayed at the top of the list.

1. From the service menu select Error history
 2. Press CONFIRM.
- Please see section 8. for error code diagnosis and actions.

To delete an Error history item;

1. From Error history screen press F4 button (Rubbish bin icon)
2. Then press F3 button (Yes).

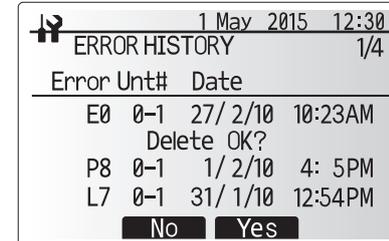
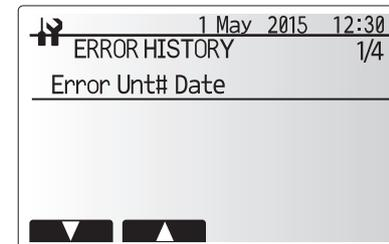

<Password protection>

Password protection is available to prevent unauthorised access to the service menu by untrained persons.

1. From the service menu use F1 and F2 buttons to scroll through list until Password protection is highlighted.
2. Press CONFIRM.
3. When password input screen is displayed use buttons F1 and F2 to move left and right between the 4 digits, F3 to lower the selected digit by 1, and F4 to increase the selected digit by 1.
4. When you have input your password press CONFIRM.
5. The password verify screen is displayed.
6. To verify your new password press button F3.
7. Your password is now set and the completion screen is displayed.



Password input screen



Password verify screen

Resetting the password

If you forget the password you entered, or have to service a unit somebody else installed, you can reset the password to the factory default of **0000**.

1. From the main settings menu scroll down the functions until Service Menu is highlighted.
2. Press CONFIRM.
3. You will be prompted to enter a password.
4. Hold down buttons F3 and F4 together for 3 seconds
5. You will be asked if you wish to continue and reset the password to default setting.
6. To reset press button F3.
7. The password is now reset to **0000**.



Completion screen

<Manual reset>

Should you wish to restore the factory settings at any time you should use the manual reset function. Please note this will reset ALL functions to the factory default settings.

1. From the service menu use F1 and F2 buttons to scroll through list until Manual Reset is highlighted.
2. Press CONFIRM.
3. The Manual reset screen is displayed.
4. Choose either Manual Reset for FTC or Main remote controller.
5. Press F3 button to confirm manual reset of chosen device.

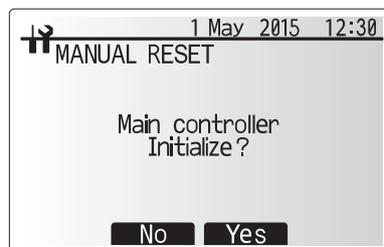
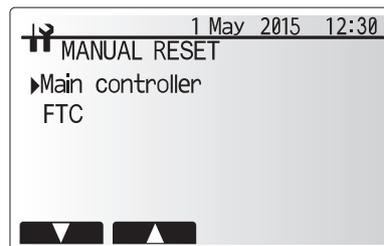

<SD card>

The use of an SD memory card simplifies the main remote controller settings in the field.

*Ecoda service tool (for use with PC tool) is necessary for the setting.

SD → Main RC

1. From the SD card setting use F1 and F2 buttons to scroll through list until "SD → Main RC" is highlighted.
 2. Press CONFIRM.
 3. Press F3 and F4 buttons to set the Ref. address. *1
 4. Use F1, F2 and F3 buttons to select a menu to write to the main remote controller.
 5. Press CONFIRM to start downloading.
 6. Wait for a few minutes until "Complete!" appears.
- *1 For multiple outdoor units control system only.

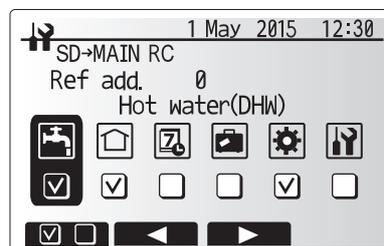
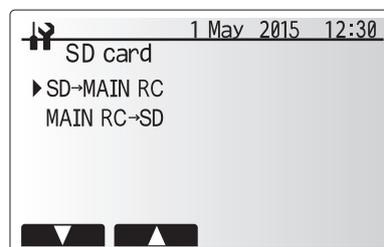

Main RC → SD

1. From the SD card setting use F1 and F2 buttons to scroll through list until Main RC → SD is highlighted.
 2. Press CONFIRM.
 3. Press F3 and F4 buttons to set the Ref. address. *1
 4. Use F1, F2 and F3 buttons to select a menu to write to the SD memory card.
 5. Press CONFIRM to start uploading.
 6. Wait for a few minutes until "Complete!" appears.
- *1 For multiple outdoor units control system only.

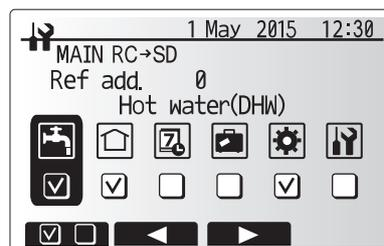

<Table 7.3>

Request code	Request content	Range	Unit
103	Error history 1 (latest)	Displays error history. ("—" is displays if no history is present.)	Code
104	Error history 2 (second to last)	Displays error history. ("—" is displays if no history is present.)	—
105	Error history 3 (third to last)	Displays error history. ("—" is displays if no history is present.)	—
154	Water circulation pump 1 - Accumulated operating time (after reset)	0 - 9999	10 hours
156	Water circulation pump 2 - Accumulated operating time (after reset)	0 - 9999	10 hours
157	Water circulation pump 3 - Accumulated operating time (after reset)	0 - 9999	10 hours
158	Water circulation pump 4 - Accumulated operating time (after reset)	0 - 9999	10 hours
162	Indoor unit - DIP SW1 setting information	Refer to detail contents described hereinafter.	—
163	Indoor unit - DIP SW2 setting information	Refer to detail contents described hereinafter.	—
164	Indoor unit - DIP SW3 setting information	Refer to detail contents described hereinafter.	—
165	Indoor unit - DIP SW4 setting information	Refer to detail contents described hereinafter.	—
166	Indoor unit - DIP SW5 setting information	Refer to detail contents described hereinafter.	—
175	Indoor unit - Output signal information	Refer to detail contents described hereinafter.	—
176	Indoor unit - Input signal information	Refer to detail contents described hereinafter.	—
177	Mixing valve opening step	0 - 10	Step
190	Indoor unit - Software version 1st 4 digits	Refer to Note below.	—
191	Indoor unit - Software version last 4 digits	Refer to Note below.	—
200	Initialisation of Function Setting	—	—
340	Water circulation pump 1 - Accumulated operating time reset	—	—
342	Water circulation pump 2 - Accumulated operating time reset	—	—
343	Water circulation pump 3 - Accumulated operating time reset	—	—
344	Water circulation pump 4 - Accumulated operating time reset	—	—
504	Indoor unit - Zone 1 room temp. (TH1A)	-39 - 88	°C
505	Indoor unit - Ref. liquid temp. (TH2)	-39 - 88	°C
506	Indoor unit - Return water temp. (THW2)	-39 - 88	°C
507	Indoor unit - Zone 2 room temp. (TH1B)	-39 - 88	°C
508	Indoor unit - DHW tank water temp. (THW5)	-39 - 88	°C
509	Indoor unit - Zone 1 flow water temp. (THW6)	-39 - 88	°C
510	Indoor unit - Outside air temp. (TH7)	-39 - 88	°C
511	Indoor unit - Flow water temp. (THW1)	-39 - 88	°C
512	Indoor unit - Zone 1 return water temp. (THW7)	-39 - 88	°C
513	Indoor unit - Zone 2 flow water temp. (THW8)	-39 - 88	°C
514	Indoor unit - Zone 2 return water temp. (THW9)	-39 - 88	°C
515	Indoor unit - Boiler flow water temp. (THWB1)	-40 - 140	°C
516	Indoor unit - Boiler return water temp. (THWB2)	-40 - 140	°C
540	Flow rate of the primary circuit	0 - 100	L/min.
550	Indoor unit - Error postponement history 1 (latest)	Displays postponement code. ("—" is displays if no postponement code is present.)	—
551	Indoor unit - Operation control at time of error	0 Standard, 1 Heater, 2 Boiler	—
552	Indoor unit - Operation mode at time of error	0 OFF, 1 DHW, 2 Heating, 3 Cooling, 4 Legionella prevention, 5 Freeze protection, 6 Operation stop, 7 Defrost	—
553	Indoor unit - Output signal information at time of error	Refer to detail contents described hereinafter	—
554	Indoor unit - Input signal information at time of error	Refer to detail contents described hereinafter	—
555	Indoor unit - Zone 1 room temp. (TH1A) at time of error	-39 - 88	°C
556	Indoor unit - Zone 2 room temp. (TH1B) at time of error	-39 - 88	°C
557	Indoor unit - Ref. liquid temp. (TH2) at time of error	-39 - 88	°C
558	Indoor unit - Flow water temp. (THW1) at time of error	-39 - 88	°C
559	Indoor unit - Return water temp. (THW2) at time of error	-39 - 88	°C
560	Indoor unit - DHW tank water temp. (THW5) at time of error	-39 - 88	°C
561	Indoor unit - Zone 1 flow water temp. (THW6) at time of error	-39 - 88	°C
562	Indoor unit - Zone 1 return water temp. (THW7) at time of error	-39 - 88	°C
563	Indoor unit - Zone 2 flow water temp. (THW8) at time of error	-39 - 88	°C
564	Indoor unit - Zone 2 return water temp. (THW9) at time of error	-39 - 88	°C
565	Indoor unit - Boiler flow water temp. (THWB1) at time of error	-40 - 140	°C
566	Indoor unit - Boiler return water temp. (THWB2) at time of error	-40 - 140	°C
567	Indoor unit - Failure (P1/P2/L5/L8/Ld) thermistor	0 Failure thermistor is none, 1 TH1A, 2 TH2, 3 THW1, 4 THW2, 5 THWB1, 6 THW5, 7 THWB2, 8 TH1B, A THW6, B THW7, C THW8, D THW9	—
568	Mixing valve opening step at time of error	0 - 10	Step
569	Operated Flow switch at time of failure (L9)	0 No operated flow switch, 1 Flow switch 1, 2 Flow switch 2, 3 Flow switch 3	—
571	Flow rate at time of error	0 - 100	L/min.

Note
Refer to outdoor unit service manual for request code 0 to 102, 106 to 149.
Request codes 103 to 105 indicate error histories of both indoor and outdoor units.
As only four digits can be displayed at one time the software version number is displayed in two halves.
Enter code 190 to see the first four digits and code 191 to see the last four digits.
For example software version No. 5.01 A000, when code 190 is entered 0501 is displayed, when code 191 is entered A000 is displayed.
Request code 200 resets all Function Setting to the factory default settings.

8.1 Cylinder unit

The indoor hydrobox must be serviced **once a year** by a qualified individual. Servicing and maintenance of the outdoor unit should only be done by a Mitsubishi Electric trained technician with relevant qualifications and experience. Any electrical work should be done by a trades person with the appropriate electrical qualifications. Any maintenance or 'DIY' fixes done by a non-accredited person could invalidate the Warranty and/or result in damage to the hydrobox and injury to the person.

Basic Troubleshooting for Cylinder unit

No.	Fault symptom	Possible cause	Explanation - Solution
1	Main remote controller display is blank.	<ol style="list-style-type: none"> There is no power supply to main remote controller. Power is supplied to main remote controller, however, the display on the main remote controller does not appear. 	<ol style="list-style-type: none"> Check LED2 on FTC. (See 3.1.1 Wiring Diagrams.) <ol style="list-style-type: none"> When LED2 is lit. Check for damage or contact failure of the main remote controller wiring. When LED2 is blinking. Refer to No. 5 below. When LED2 is not lit. Refer to No. 4 below. Check the following: <ul style="list-style-type: none"> Disconnection between the main remote controller cable and the FTC control board Failure of the main remote controller if "Please Wait" is not displayed. Refer to No. 2 below if "Please Wait" is displayed.
2	"Please Wait" remains displayed on the main remote controller.	<ol style="list-style-type: none"> "Please Wait" is displayed for up to 6 minutes. Communication failure between the main remote controller and FTC. Communication failure between FTC and outdoor unit. 	<ol style="list-style-type: none"> Normal operation. 3. Main remote controller start up checks/procedure. <ol style="list-style-type: none"> If "0%" or "50-99%" is displayed below "Please Wait" there is a communication error between the main remote controller and the FTC control board. <ul style="list-style-type: none"> Check wiring connections on the main remote controller. Replace the main remote controller or the FTC control board. If "1-49%" is displayed there is a communication error between the outdoor unit's and FTC's control boards. <ul style="list-style-type: none"> Check the wiring connections on the outdoor unit control board and the FTC control board. (Ensure S1 and S2 are not cross-wired and S3 is securely wired with no damage. (See 3.1.4 Electrical Connection.) Replace the outdoor unit's and/or the FTC's control boards.
3	The main screen appears with a press of the "ON" button, but disappears in a second.	The main remote controller operations do not work for a while after the settings are changed in the service menu. This is because the system takes time to apply the changes.	Normal operation. The indoor unit is applying updated settings made in the service menu. Normal operation will start shortly.
4	LED2 on FTC is off. (See 3.1.1 Wiring Diagrams.)	When LED1 on FTC is also off. (See 3.1.1 Wiring Diagrams.) <FTC powered via outdoor unit.> <ol style="list-style-type: none"> The outdoor unit is not supplied at the rated voltage. Defective outdoor controller circuit board. FTC is not supplied with 220 to 240V AC. FTC failure. Faulty connector wiring. 	<ol style="list-style-type: none"> Check the voltage across the terminals L and N or L3 and N on the outdoor power board. (See 3.1.4 Electrical Connection.) <ul style="list-style-type: none"> When the voltage is not 220 to 240V AC, check wiring of the outdoor unit and of the breaker. When the voltage is at 220 to 240V AC, go to "2." below. Check the voltage across the outdoor unit terminals S1 and S2. (See 3.1.4 Electrical Connection.) <ul style="list-style-type: none"> When the voltage is not 220 to 240V AC, check the fuse on the outdoor control board and check for faulty wiring. When the voltage is 220 to 240V AC, go to "3." below. Check the voltage across the indoor unit terminals S1 and S2. (See 3.1.4 Electrical Connection.) <ul style="list-style-type: none"> When the voltage is not 220 to 240V AC, check FTC-outdoor unit wiring for faults. When the voltage is 220 to 240V AC, go to "4." below. Check the FTC control board. <ul style="list-style-type: none"> Check the fuse on FTC control board. Check for faulty wiring. If no problem found with the wiring, the FTC control board is faulty. Check the connector wiring. <ul style="list-style-type: none"> When the connectors are wired incorrectly, re-wire the connectors referring to below. (See 3.1.4 Electrical Connection.)

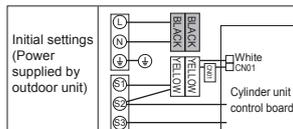

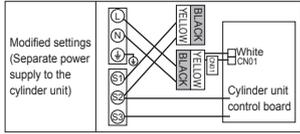
No.	Fault symptom	Possible cause	Explanation - Solution
4	LED2 on FTC is off. (See 3.1.1 Wiring Diagrams.)	<FTC powered on independent source> 1. FTC is not supplied with 220 to 240V AC. 2. There are problems in the method of connecting the connectors. 3. FTC failure.	1. Check the voltage across the L and N terminals on the indoor power supply terminal block. (See 3.1.4 Electrical Connection.) • When the voltage is not 220 to 240V AC, check for faulty wiring to power supply. • When the voltage is 220 to 240V AC, go to 2. below. 2. Check for faulty wiring between the connectors. • When the connectors are wired incorrectly re-wire them correctly referring to below. (See 3.1.4 Electrical Connection and a wiring diagram on the control and electrical box cover.)  • If no problem found with the wiring, go to 3. below. 3. Check the FTC control board. • Check the fuse on FTC control board. • Check for faulty wiring. • If no problem found with the wiring, the FTC control board is faulty.
		When LED1 on FTC is lit. Incorrect setting of refrigerant address for outdoor unit. (None of the refrigerant address is set to "0".)	Recheck the refrigerant address setting on the outdoor unit. Set the refrigerant address to "0". (Set refrigerant address using SW1(3 - 6) on outdoor controller circuit board.)
5	LED2 on FTC is blinking. (See 3.1.1 Wiring Diagrams.)	When LED1 is also blinking on FTC . Faulty wiring between FTC and outdoor unit	Check for faulty wiring between FTC and outdoor unit.
		When LED1 on FTC is lit. 1. Faulty wiring in main remote controller Multiple indoor units have been wired to a single outdoor unit. 2. Short-circuited wiring in main remote controller 3. Main remote controller failure	1. Check for faulty wiring in main remote controller. The number of indoor units that can be wired to a single outdoor unit is one. Additional indoor units must be wired individually to a single outdoor unit. 2,3. Remove main remote controller wires and check LED2 on FTC. (See 3.1.1 Wiring Diagrams.) • If LED2 is blinking check for short circuits in the main remote controller wiring . • If LED2 is lit, wire the main remote controller again and: - if LED2 is blinking, the main remote controller is faulty; - if LED2 is lit, faulty wiring of the main remote controller has been corrected.
6	LED4 on FTC is off. (See 3.1.1 Wiring Diagrams.)	1. SD memory card is NOT inserted into the memory card slot with correct orientation. 2. Not an SD standards compliant memory card.	1. Correctly insert SD memory card in place until a click is heard. 2. Use an SD standards compliant memory card. (Refer to 3.3 Using SD memory card.)
	LED4 on FTC is blinking. (See 3.1.1 Wiring Diagrams.)	1. Full of data. 2. Write-protected. 3. NOT formatted. 4. Formatted in NTFS file system.	1. Move or delete data, or replace SD memory card with a new one. 2. Release the write-protect switch. 3. Refer to 3.3 Using SD memory card. 4. FTC is Not compatible with NTFS file system. Use an SD memory card formatted in FAT file system.
7	No water at hot tap.	1. Cold main off 2. Strainer (local supply) blocked.	1. Check and open stop cock. 2. Isolate water supply and clean strainer.
8	Cold water at tap.	1. Hot water run out. 2. Prohibit, schedule timer or holiday mode selected or demand control input (IN4) or smart grid ready (switch-off command). 3. Heat pump not working. 4. Booster heater cut-out tripped.	1. Ensure DHW mode is operating and wait for DHW tank to re-heat. 2. Check settings and change as appropriate. 3. Check heat pump – consult outdoor unit service manual. 4. Check booster heater thermostat and press reset button if safe. Reset button is located on the side of booster heater, covered with white rubber cap. See 4. PART NAMES AND FUNCTIONS in Service Handbook or 3. Technical Parts in Installation Manual to find out its position. 5. Check the cause and reset if safe.
		5. The earth leakage circuit breaker for booster heater breaker (ECB1) tripped. 6. The booster heater thermal cut-out has tripped and cannot be reset using the manual reset button. 7. Immersion heater cut-out tripped. 8. Immersion heater breaker (ECB2) tripped. 9. 3-way valve fault	6. Check resistance across the thermal cut-out, if open then the connection is broken and the booster heater will have to be replaced. Contact your Mitsubishi Electric dealer. 7. Check immersion heater thermostat and press reset button, located on immersion heater thermostat, if safe. If the heater has been operated with no water inside it may have failed, so please replace it with a new one. 8. Check the cause and reset if safe. 9. Check plumbing/wiring to 3-way valve. (i) Manually override 3-way valve using the main remote controller. (Refer to <Manual operation> in 7. System Set Up.) If the valve does not still function, go to (ii) below. (ii) Replace 3-way valve coil. If the valve does not still function, go to (iii) below. (iii) Replace 3-way valve. (Refer to 11. DISASSEMBLY PROCEDURE in Service handbook.)

No.	Fault symptom	Possible cause	Explanation - Solution
9	Water heating takes longer.	<ol style="list-style-type: none"> Heat pump not working. Booster heater cut-out tripped. Booster heater breaker (ECB1) tripped. The booster heater thermal cut-out has tripped and cannot be reset using the manual reset button. Immersion heater cut-out has been triggered. Immersion heater breaker (ECB2) tripped. 	<ol style="list-style-type: none"> Check heat pump – consult outdoor unit service manual. Check booster heater thermostat and press reset button if safe. Reset button is located on the side of booster heater, covered with white rubber cap. See 4. PART NAMES AND FUNCTIONS in Service Handbook or 3. Technical Parts in Installation Manual to find out its position. Check the cause and reset if safe. Check resistance across the thermal cut-out, if open then connection is broken and the booster heater will have to be replaced. Contact your Mitsubishi Electric dealer. Check immersion heater thermostat and press reset button located on immersion heater boss, if safe. If the heater kept running with no water inside, this may have resulted in failure, so replace it with a new one. Check the cause and reset if safe.
10	Temperature of DHW tank water dropped.	<p>When DHW operation is not running, the DHW tank emits heat and the water temperature decreases to a certain level. If water in the DHW tank is reheated frequently because of a significant drop in water temperature, check for the following.</p> <ol style="list-style-type: none"> Water leakage in the pipes that connect to the DHW tank Insulation material coming loose or off. 3-way valve failure 	<ol style="list-style-type: none"> Take the following measures. <ul style="list-style-type: none"> Retighten the nuts holding the pipes onto the DHW tank. Replace seal materials. Replace the pipes. Fix insulation. Check plumbing/wiring to 3-way valve. <ol style="list-style-type: none"> Manually override 3-way valve using the main remote controller. (Refer to <Manual operation> in 7. System Set Up.) If the valve does not still function, go to (ii) below. Replace 3-way valve motor. If the valve does not still function, go to (iii) below. Replace 3-way valve. (Refer to 11. DISASSEMBLY PROCEDURE in Service handbook.)
11	Hot or warm water from cold tap.	Heat of hot water pipe is transferred to cold water pipe.	Insulate/re-route pipework.
12	Water leakage	<ol style="list-style-type: none"> Poorly sealed connections of water circuit components Water circuit components reaching the end of life 	<ol style="list-style-type: none"> Tighten connections as required. Refer to PARTS CATALOG for expected part lifetimes and replace them as necessary.
13	Heating system does not reach the set temperature.	<ol style="list-style-type: none"> Prohibit, schedule timer or holiday mode selected or demand control input (IN4) or smart grid ready (switch-off command). Check settings and change as appropriate. The temperature sensor is located in a room that has a different temperature relative to that of the rest of the house. Heat pump not working. Booster heater cut-out tripped. Booster heater breaker (ECB1) tripped. The booster heater thermal cut-out tripped and can not be reset using the manual reset button. Incorrectly sized heat emitter. 3-way valve failure Battery problem (*wireless control only) If a mixing tank is installed, the flow rate between the mixing tank and the cylinder unit is less than that between the mixing tank and the local system. 	<ol style="list-style-type: none"> Check settings and change as appropriate. Check the battery power and replace if flat. Relocate the temperature sensor to a more suitable room. Check heat pump – consult outdoor unit service manual. Check booster heater thermostat and press reset button if safe. Reset button is located on the side of booster heater, covered with white rubber cap. (See 4. PART NAMES AND FUNCTIONS in Service Handbook or 3. Technical Parts in Installation Manual to find out its position.) Check the cause of the trip and reset if safe. Check resistance across the thermal cut-out, if open then the connection is broken and the booster heater will have to be replaced. Contact your Mitsubishi Electric dealer. Check the heat emitter surface area is adequate. Increase size if necessary. Check plumbing/wiring to 3-way valve. <ol style="list-style-type: none"> Manually override 3-way valve using the main remote controller. (Refer to <Manual operation> in 7. System Set Up). If the 3-way valve does not function, go to (ii) below. Replace 3-way valve motor. If the 3-way valve coil is replaced but the 3-way valve does not function go to (iii) below. Replace 3-way valve. (Refer to 11. DISASSEMBLY PROCEDURE in Service handbook.) Check the battery power and replace if flat. Increase the flow rate between the mixing tank and the cylinder unit decrease that between the mixing tank and the local system.

No.	Fault symptom	Possible cause	Explanation - Solution
14	In 2-zone temperature control, only Zone2 does not reach the set temperature.	<ol style="list-style-type: none"> When Zone1 and Zone2 are both in heating mode, the hot water temperature in Zone2 does not exceed that in Zone1. Faulty wiring of motorized mixing valve Faulty installation of motorized mixing valve Incorrect setting of Running time Motorized mixing valve failure 	<ol style="list-style-type: none"> Normal action no action necessary. See 3.5 Wiring for 2-zone temperature control. Check for correct installation. (Refer to the manual included with each motorized mixing valve.) Check for correct setting of Running time. Inspect the mixing valve. (Refer to the manual included with each motorized mixing valve.)
15	When a PUHZ-FRP outdoor unit is connected, DHW or Heating operation cannot run.	The outdoor unit is set to have operation of the indoor unit of air conditioner take precedence over that of the cylinder unit, and in the main remote controller settings "Electric heater (Heating)" or "Electric heater (DHW)" is turned off.	Turn ON Electric heater (Heating) or Electric heater (DHW) using the main remote controller.
16	When a PUHZ-FRP outdoor unit is connected and is in heat recovery operation, the set temperature is not reached.	When the outdoor unit is set to have cooling operation of the indoor unit of air conditioner take precedence over that of the cylinder unit, the outdoor unit controls the frequency of the compressor according to the load of air conditioner. The DHW and heating run according to that frequency.	Normal operation no action necessary. If Air-to-Water system is given priority in operation, comp Hz can be regulated depending on the load of DHW or Heating. For more details, refer to the PUHZ-FRP installation manual.
17	After DHW operation room temperature rises slightly.	At the end of the DHW mode operation the 3-way valve diverts hot water away from the DHW circuit into space heating circuit. This is done to prevent the cylinder unit components from overheating. The amount of hot water directed into the space heating circuit varies according to the type of the system and of the pipe run between the plate heat exchanger and the cylinder unit.	Normal operation no action necessary.
18	The room temperature rises during DHW operation.	3-way valve failure	Check the 3-way valve. <ol style="list-style-type: none"> Manually override 3-way valve using the main remote controller. (Refer to <Manual operation> in 7. System Set Up). If the 3-way valve does not function, go to (ii) below. Replace 3-way valve coil. If the 3-way valve coil is replaced but the 3-way valve does not function go to (iii) below. Replace 3-way valve. (Refer to 11. DISASSEMBLY PROCEDURE in Service handbook.)
19	Water discharges from pressure relief valve. (Primary circuit)	<ol style="list-style-type: none"> If continual – pressure relief valve could bite foreign objects and the valve seat may be damaged. If intermittent – expansion vessel charge may have reduced/bladder perished. 	<ol style="list-style-type: none"> Turn the handle on the pressure relief valve several turns. If leakage persists, replace the pressure relief valve with a new one. Check pressure in expansion vessel. Recharge to 1 bar if necessary. If bladder perished replace expansion vessel with a new one.
20	Water discharges from pressure relief valve (accessory supplied item). (Sanitary circuit)	<ol style="list-style-type: none"> If continual – field supplied pressure reducing valve not working. If continual – pressure relief valve could bite foreign objects and the valve seat may be damaged. If intermittent – expansion vessel charge may have reduced/bladder perished. DHW tank may have subjected to backflow. 	<ol style="list-style-type: none"> Check function of pressure reducing valve and replace if necessary. Turn the handle on the pressure relief valve several turns. If leakage persists, replace the pressure relief valve with a new one. Check gas-side pressure in expansion vessel. Recharge to correct precharge pressure if necessary. If bladder perished replace expansion vessel with a new one with appropriate pre-charge. Check the pressure in DHW tank. If pressure in DHW tank is similar to that in the incoming mains, cold water supply that merges with incoming mains water supply could flow back to DHW tank. Investigate source of back-feed and rectify error in pipework/fitting configuration. Adjust pressure in cold supply.
21	Water discharges from temperature and pressure relief valve (EHPT20X-VM2HB only) (Sanitary circuit)	<ol style="list-style-type: none"> If continual – field supplied pressure reducing valve not working. If continual – temperature and pressure relief valve could bite foreign objects and the valve seat may be damaged. If intermittent – expansion vessel charge may have reduced/bladder perished. DHW tank may have subjected to backflow. Unit has overheated – thermal controls have failed. 	<ol style="list-style-type: none"> Check function of pressure reducing valve and replace if necessary. Turn the handle on the temperature and pressure relief valve several turns. If leakage persists, replace the temperature and pressure relief valve with a new one. Check gas-side pressure in expansion vessel. Recharge to correct precharge pressure if necessary. If bladder perished replace expansion vessel with a new one with appropriate pre-charge. Check pressure in DHW tank. If pressure in DHW tank is similar to that in the incoming mains, cold water supply that merges with incoming mains water supply could flow back to DHW tank. Investigate source of back-feed and rectify error in pipework/fitting configuration. Adjust pressure in cold supply. Switch off power to the heat pump and immersion heaters. Leave water running. Wait until discharge stops. Isolate water supply and replace if faulty.

No.	Fault symptom	Possible cause	Explanation - Solution																
22	Water discharges from expansion relief valve - part of Inlet Control Group (EHPT20X-VM2HB only) (sanitary circuit).	<ol style="list-style-type: none"> If continual – field supplied pressure reducing valve not working. If continual – expansion relief valve may be damaged. If intermittent – expansion vessel charge may have reduced/bladder perished. DHW tank may have subjected to backflow. Unit has overheated – thermal controls have failed. 	<ol style="list-style-type: none"> Check function of pressure reducing valve and replace if necessary. Turn the handle on the expansion relief valve to check for foreign objects inside. If the problem is not still solved, replace the expansion relief valve with a new one. Check gas-side pressure in expansion vessel. Recharge to correct precharge pressure if necessary. If bladder perished replace expansion vessel with a new one with appropriate precharge. Check pressure in DHW tank. If pressure in DHW tank is similar to that in the incoming mains, cold water supply that merges with incoming mains water supply could flow back to DHW tank. Investigate source of back-feed and rectify error in pipework/fitting configuration. Adjust pressure in cold supply. Switch off power to the heat pump and immersion heaters. Leave water running. Wait until discharge stops. Isolate water supply and replace if faulty. 																
23	Noisy water circulation pump	Air in water circulation pump.	Use manual and automatic air vents to remove air from system. Top up water if necessary to achieve 1 bar on primary circuit.																
24	Noise during hot water draw off typically worse in the morning.	<ol style="list-style-type: none"> Loose airing cupboard pipework. Heaters switching on/off. 	<ol style="list-style-type: none"> Install extra pipe fastening clips. Normal operation no action necessary. 																
25	Mechanical noise heard coming from the cylinder unit.	<ol style="list-style-type: none"> Heaters switching on/off. 3-way valve changing position between DHW and heating mode. 	Normal operation no action necessary.																
26	Water circulation pump runs for a short time unexpectedly.	Water circulation pump jam prevention mechanism (routine) to inhibit the build-up of scale.	Normal operation no action necessary.																
27	Milky/Cloudy water (Sanitary circuit)	Oxygenated water	Water from any pressurised system will release oxygen bubbles when water is running. The bubbles will settle out.																
28	Heating mode has been on standby for a long time (does not start operation smoothly.)	The time of "Delay" set in "Economy settings for pump" is too short. (Go to "Service menu" → "Auxiliary settings" → "Economy settings for pump").	Increase the time of "Delay" in "Economy settings for pump" .																
29	The cylinder unit that was running in the heating mode before power failure is running in the DHW mode after power recovery.	The cylinder unit is designed to run in an operation mode with a higher priority (i.e. DHW mode in this case) at power recovery.	<ul style="list-style-type: none"> Normal operation. After the DHW max. operation time has elapsed or the DHW max. temperature has been reached, the DHW mode switches to the other mode (ex. Heating mode). 																
30	Cooling mode is NOT available.	DIP SW2-4 is OFF.	Turn DIP SW2-4 to ON. (Refer to "3.1.2. DIP switch functions".)																
31	The cooling system does not cool down to the set temperature.	<ol style="list-style-type: none"> When the water in the circulation circuit is unduly hot, Cooling mode starts with a delay for the protection of the outdoor unit. When the outdoor ambient temperature is lower than the preset temperature that activates the freeze stat function, Cooling mode does not start running. 	<ol style="list-style-type: none"> Normal operation. To run Cooling mode overriding the freeze stat function, adjust the preset temperature that activates the freeze stat function. (Refer to "<Freeze stat function>" on Page B-84.) 																
32	The electric heaters are activated shortly after DHW or LP mode starts running after Cooling mode.	The setting time period of Heat-pump-only operation is short.	Adjust the setting time period of Heat-pump only operation. (Refer to "<Electric heater (DHW)>" on Page B-82.																
33	During DHW or LP mode following the cooling mode, error L6 (circulation water freeze protection error) occurs and the system stops all the operations.	The unit runs in Cooling mode when the outdoor ambient temperature is lower than 10°C (outside of the guaranteed operating range). (When defrosting operation is running at such a low outdoor ambient temperature after Cooling mode is switched to DHW or LP mode, the water temperature in the cooling circuit drops too low, which could result in L6 error to stop all the operations.	<p>Do not run Cooling operation when the outdoor ambient temperature is lower than 10°C.</p> <p>To automatically stop or recover only Cooling operation and keep other operations running, the freeze stat function can be used. Set the preset temperature that activates the freeze stat function to adjust the outdoor ambient temperature as follows. (Refer to "<Freeze stat function>" on Page B-84.)</p> <table border="1"> <thead> <tr> <th>Outdoor ambient temperature</th> <th>Cooling operation</th> </tr> </thead> <tbody> <tr> <td>3°C higher than the preset temperature</td> <td>Stop</td> </tr> <tr> <td>5°C higher than the preset temperature</td> <td>Recover</td> </tr> </tbody> </table>	Outdoor ambient temperature	Cooling operation	3°C higher than the preset temperature	Stop	5°C higher than the preset temperature	Recover										
Outdoor ambient temperature	Cooling operation																		
3°C higher than the preset temperature	Stop																		
5°C higher than the preset temperature	Recover																		
34	The energy monitor value seems not correct. Note: There could be some discrepancies between the actual and the calculated values. If you seek for accuracy, please make sure to connect power meter(s) and heat meter to FTC board. Both should be locally supplied.	<ol style="list-style-type: none"> Incorrect setting of the energy monitor Non-connectable type of external meter (local supply) is connected. External meter (local supply) failure FTC board failure 	<ol style="list-style-type: none"> Check the setting by following the procedure below. (1) Check if the DIP switch is set as the table below. <table border="1"> <thead> <tr> <th colspan="2">Consumed electric energy</th> <th colspan="2">Delivered heat energy</th> </tr> </thead> <tbody> <tr> <td>SW3-4</td> <td>Electric energy meter (Local supply)</td> <td>SW3-8</td> <td>Heat meter (Local supply)</td> </tr> <tr> <td>OFF</td> <td>Without</td> <td>OFF</td> <td>Without</td> </tr> <tr> <td>ON</td> <td>With</td> <td>ON</td> <td>With</td> </tr> </tbody> </table> In the case external electric energy meter and/or heat meter is not used, check if the setting for electric heater and water pump(s) input is correct by referring to <Energy monitor setting> in 6. System Set Up. In the case external electric energy meter and/or heat meter is used, check if the unit of output pulse on external meter matches with the one set at the main remote controller by referring to <Energy monitor setting> in 6. System Set Up. Check if the external meter (local supply) is connectable type by referring to <Energy monitor setting>" in section 6. System Set Up. Check if signal is sent to IN8 to IN10 properly. (Refer to section 3.1.1 Wiring Diagrams) Replace the external heat meter if defective. Check the FTC control board. <ul style="list-style-type: none"> Check for faulty wiring. If no problem found with the wiring, the FTC control board is faulty. Replace the board. 	Consumed electric energy		Delivered heat energy		SW3-4	Electric energy meter (Local supply)	SW3-8	Heat meter (Local supply)	OFF	Without	OFF	Without	ON	With	ON	With
Consumed electric energy		Delivered heat energy																	
SW3-4	Electric energy meter (Local supply)	SW3-8	Heat meter (Local supply)																
OFF	Without	OFF	Without																
ON	With	ON	With																
35	Heat pump is forced to turn ON and OFF.	Smart grid ready input (IN11 and IN12) is used, and switch-on and off commands are input.	Normal operation no action necessary.																

Annual Maintenance

It is essential that the cylinder unit is serviced at least once a year by a qualified individual. Any spare parts required should be purchased from Mitsubishi Electric. NEVER bypass safety devices or operate the unit without them being fully operational. For more details, refer to service handbook.

Annual Maintenance Log Book

Contractor name		Engineer name	
Site name		Site number	
Cylinder unit maintenance record sheet			
Warranty number		Model number	
		Serial number	
No.	Mechanical	Frequency	Notes
1	Turn OFF water supply, drain DHW tank, remove mesh from strainer clean and replace in strainer. *1		
2	Keep water supply OFF, open hot water taps and check the primary-side expansion vessel charge pressure. Top up if necessary (1 bar).		
3	Keep water supply OFF and check the potable vessel charge pressure. Top up if necessary (3.5 bar).		
4	Keep water supply OFF. In hard water areas de-scaling of the immersion heaters may be required.		
5	Drop the primary/heating system pressure to zero check and if necessary top up the expansion vessel (1 bar). Air valve of expansion vessel is TR-412.		
6	Turn water supply ON, open the pressure relief valve and then the expansion relief valve in turn. Check for unrestricted discharge to the tundish and that the valves reseal correctly. Check there are no blockages in the tundish and associated pipework.		
7	Check and if necessary top up the concentration of anti-freeze/inhibitor (if used in the system).		
8	Top up the primary/heating system using a temporary backflow prevention filling loop and re-pressurise to 1 bar.		
9	Heat system and check pressure does not rise above 3 bar and no water is released from the safety valves.		
10	Release any air from the system.		
11	To check the 3-way valve for inside leaks, confirm that the temperature of the heat emitter does not rise when running the DHW mode.		
Refrigerant models only [except EHPT20 series]		Frequency	Notes
1	Refer to outdoor unit manual.		
Electrical		Frequency	Notes
1	Check condition of cables.		
2	Check rating and fuse fitted on the electricity supply.		
Controller		Frequency	Notes
1	Check field settings against factory recommendations.		
2	Check operation of motorized valves ensure they reseal correctly.		
3	Check battery power of wireless thermostat and replace if necessary.		
Outdoor heat pump unit maintenance record sheet			
Model number		Serial number	
	Mechanical	Frequency	Notes
1	Inspect grill and air inlet for trapped debris/damage.		
2	Check condensate drain provision.		
3	Check integrity of water pipework and insulation.		
4	Check all electrical connections.		
5	Check and record the operation voltage.		

* Checks should be carried out once a year.

*1 Be sure to reattach the mesh after washing.

Note: Within the first couple of months of installation, remove and clean the cylinder unit's strainer mesh plus any that are fitted external to the cylinder unit. This is especially important when installing on an existing system.

In addition to annual servicing, it is necessary to replace or inspect some parts after a certain period of system operation. Please see tables below for detailed instructions. Replacement and inspection of parts should always be done by a competent person with relevant training and qualifications.

Parts which require regular replacement

Parts	Replace every	Possible failures
Pressure relief valve (PRV) Air vent (Auto/Manual) Drain cock (Primary/Sanitary circuit) Manometer Inlet control group (ICG)*	6 years	Water leakage

* OPTIONAL PARTS for UK

Parts which require regular inspection

Parts	Check every	Possible failures
Immersion heater	2 years	Earth leakage causing circuit breaker to activate (Heater is always OFF)
Water circulation pump	20,000 hrs (3 years)	Water circulation pump failure

Parts which must NOT be reused when servicing

* O-ring

* Gasket

Note: Always replace the gasket for pump with a new one at each regular maintenance (every 20,000 hours of use or every 3 years).

■ Error Codes

Code	Error	Action
L3	Circulation water temperature overheat protection	Flow rate may be reduced check for; <ul style="list-style-type: none"> • Water leakage • Strainer blockage • Water circulation pump function (Error code may display during filling of primary circuit, complete filling and reset error code.)
L4	DHW tank water temperature overheat protection	Check the immersion heater and it's contactor.
L5	Indoor unit temperature thermistor (THW1, THW2, THW5, THW6, THW7, THW8, THW9) failure	Check resistance across the thermistor.
L6	Circulation water freeze protection	See Action for L3.
L8	Heating operation error	Re-attach any thermistors that have become dislodged.
L9	Low primary circuit flow rate detected by flow sensor or flow switch (flow switches 1, 2, 3)	See Action for L3. If the flow sensor or flow switch itself does not work, replace it. Caution: The pump valves may be hot, please take care.
LC	Boiler circulation water temperature overheat protection	Check if the setting temperature of the Boiler for heating exceeds the restriction. (See the manual of the thermistors "PAC-TH011HT-E") Flow rate of the heating circuit from the boiler may be reduced. Check for <ul style="list-style-type: none"> • water leakage, • strainer blockage • water circulation pump function.
LD	Boiler temperature thermistor (THWB1, THWB2) failure	Check resistance across the thermistor.
LE	Boiler operation error	See Action for L8. Check the status of the boiler.
LF	Flow sensor failure	Check flow sensor cable for damage or loose connections.
LH	Boiler circulation water freeze protection	Flow rate of the heating circuit from the boiler may be reduced. Check for <ul style="list-style-type: none"> • water leakage • strainer blockage • water circulation pump function.
LJ	DHW operation error (type of external plate HEX)	<ul style="list-style-type: none"> • Check for disconnection of DHW tank water temp. thermistor (THW5). • Flow rate of the sanitary circuit may be reduced. • Check for water circulation pump function.
LL	Setting errors of DIP switches on FTC control board	For boiler operation, check that DIP SW1-1 is set to ON (With Boiler) and DIP SW2-6 is set to ON (With Mixing Tank). For 2-zone temperature control, check DIP SW2-7 is set to ON (2-zone) and DIP SW2-6 is set to ON (With Mixing Tank).
J0	Communication failure between FTC and wireless receiver	Check connection cable for damage or loose connections.
P1	Thermistor (Room temp.) (TH1) failure	Check resistance across the thermistor.
P2	Thermistor (Ref. liquid temp.) (TH2) failure	Check resistance across the thermistor.
P6	Anti-freeze protection of plate heat exchanger	See Action for L3. Check for correct amount of refrigerant.
J1 - J8	Communication failure between wireless receiver and wireless remote controller	Check wireless remote controller's battery is not flat. Check the pairing between wireless receiver to wireless remote controller. Test the wireless communication. (See the manual of wireless system)
E0 - E5	Communication failure between main remote controller and FTC	Check connection cable for damage or loose connections.
E6 - E9	Communication failure between FTC and outdoor unit	Check that the outdoor unit has not been turned off. Check connection cable for damage or loose connections. Refer to outdoor unit service manual.
E9	Outdoor unit receives no signal from indoor unit.	Check both units are switched on. Check connection cable for damage or loose connections. Refer to outdoor unit service manual.
U*, F*	Outdoor unit failure	Refer to outdoor unit service manual.
A*	M-NET communication error	Refer to outdoor unit service manual.

Note: To cancel error codes please switch system off (Press button E, on the main remote controller, for 3 seconds).

■ Engineers Forms (Cylinder unit)

Should settings be changed from default, please enter and record new setting in 'Field Setting' column. This will ease resetting in the future should the system use change or the circuit board need to be replaced.

Commissioning/Field settings record sheet

Main remote controller screen		Parameters	Default setting	Field setting	Notes	
Main	Zone1 heating room temp.		10°C - 30°C	20°C		
	Zone2 heating room temp. *13		10°C - 30°C	20°C		
	Zone1 heating flow temp.		25°C - 60°C	45°C		
	Zone2 heating flow temp. *1		25°C - 60°C	35°C		
	Zone1 cooling flow temp. *14		5°C - 25°C	15°C		
	Zone2 cooling flow temp. *14		5°C - 25°C	20°C		
	Zone1 heating compensation curve		-9°C - + 9°C	0°C		
	Zone2 heating compensation curve *1		-9°C - + 9°C	0°C		
Option	Holiday mode		Active/Non active/Set time	—		
	Forced DHW operation		On/Off	—		
	DHW		On/Off/Timer	On		
	Heating/Cooling *14		On/Off/Timer	On		
	Energy monitor		Consumed electrical energy/Delivered energy	—		
Setting	DHW	Operation mode		Normal/Eco *16	Normal	
		DHW max. temp.		40°C - 60°C *2	50°C	
		DHW temp. drop		5°C - 30°C	10°C	
		DHW max. operation time		30 - 120 min	60 min	
		DHW mode restriction		30 - 120 min	30 min	
		Duration of maximum temp.		1 - 120 min	30 min	
	Legionella prevention	Active		Yes/No	Yes	
		Hot water temp.		60°C - 70°C *2	65°C	
		Frequency		1 - 30 days	15 days	
		Start time		00.00 - 23.00	03.00	
		Max. operation time		1 - 5 hours	3 hours	
		Duration of maximum temp.		1 - 120 min	30 min	
		Zone1 operation mode		Heating room temp./ Heating flow temp./ Heating compensation curve/ Cooling flow temp.	Room temp.	
		Zone2 operation mode *1		Heating room temp./ Heating flow temp./ Heating compensation curve/ Cooling flow temp.	Compensation curve	
	Compensation curve	Hi flow temp. set point	Zone1 outdoor ambient temp.		-30°C - +33°C *3	-15°C
			Zone1 flow temp.		25°C - 60°C	50°C
			Zone2 outdoor ambient temp. *1		-30°C - +33°C *3	-15°C
			Zone2 flow temp. *1		25°C - 60°C	40°C
		Lo flow temp. set point	Zone1 outdoor ambient temp.		-28°C - +35°C *4	35°C
			Zone1 flow temp.		25°C - 60°C	25°C
			Zone2 outdoor ambient temp. *1		-28°C - +35°C *4	35°C
			Zone2 flow temp.		25°C - 60°C	25°C
		Adjust	Zone1 outdoor ambient temp.		-29°C - +34°C *5	—
			Zone1 flow temp.		25°C - 60°C	—
			Zone2 outdoor ambient temp. *1		-29°C - +34°C *5	—
			Zone2 flow temp. *1		25°C - 60°C	—
	Holiday	DHW		Active/Non active	Non active	
		Heating/Cooling *14		Active/Non active	Active	
Zone1 heating room temp.		10°C - 30°C	15°C			
Zone2 heating room temp. *13		10°C - 30°C	15°C			
Zone1 heating flow temp.		25°C - 60°C	35°C			
Zone2 heating flow temp. *1		25°C - 60°C	25°C			
Zone1 cooling flow temp. *14		5°C - 25°C	25°C			
Zone2 cooling flow temp. *14		5°C - 25°C	25°C			
Initial settings	Language		EN/FR/DE/SV/ES/IT/DA/NL/FI/NO/PT/BG/PL/CZ/RU	EN		
	°C/°F		°C/°F	°C		
	Summer time		On/Off	Off		
	Temp. display		Room/DHW tank/Room&DHW tank /Off	Off		
	Time display		hh:mm/hh:mm AM/AM hh:mm	hh:mm		
	Room sensor settings for Zone1		TH1/Main RC/Room RC1-8/"Time/Zone"	TH1		
	Room sensor settings for Zone2 *1		TH1/Main RC/Room RC1-8/"Time/Zone"	TH1		
	Room RC zone select *1		Zone1/Zone2	Zone1		
Service menu	Thermistor adjustment	THW1		-10°C - +10°C	0°C	
		THW2		-10°C - +10°C	0°C	
		THW5		-10°C - +10°C	0°C	
		THW6		-10°C - +10°C	0°C	
		THW7		-10°C - +10°C	0°C	
		THW8		-10°C - +10°C	0°C	
		THW9		-10°C - +10°C	0°C	
		THWB1		-10°C - +10°C	0°C	
		THWB2		-10°C - +10°C	0°C	
	Auxiliary settings	Economy settings for pump.		On/Off *7	On	
		Delay (3 - 60 min)			10 min	
		Electric heater (Heating)	Space heating: On (used)/Off (not used)		On	
			Electric heater delay timer (5 - 180 min)		30 min	
		Electric heater (DHW)	Booster heater DHW: On (used)/Off (not used)		On	
			Immersion heater DHW: On (used)/Off (not used)		On	
		Electric heater delay timer (15 - 30 min)			15 min	
		Mixing valve control	Running (10 - 240 sec)		120 sec	
			Interval (1 - 30 min)		2 min	
Flow sensor *6	Minimum(0 - 100L/min)		5 L/min			
	Maximum(0 - 100L/min)		100 L/min			

*1 The settings related to Zone2 can be switched only when 2 zone temperature control is enabled (when DIP SW2-6 and SW 2-7 are ON).

*2 For the model without both booster and immersion heater, it may not reach the set temperature depending on the outside ambient temperature.

*3 The lower limit is -15°C depending on the connected outdoor unit.

*4 The lower limit is -13°C depending on the connected outdoor unit.

*5 The lower limit is -14°C depending on the connected outdoor unit.

*6 Do not change the setting since it is set according to the specification of flow sensor attached to the cylinder unit.

(Continued to next page.)

■ Engineers Forms

Commissioning/Field settings record sheet (continued from the previous page)

Main remote controller screen			Parameters	Default setting	Field setting	Notes		
Service menu	Pump speed		Pump speed(1 - 5)	5				
	Heat source setting		Standard/Heater/Boiler/Hybrid *8	Standard				
	Operation settings	Heating operation *9	Flow temp.range *11	Min.temp.(25 - 45°C) *18	30°C			
				Max.temp.(35 - 60°C)	50°C			
			Room temp.control *15	Mode(Normal/Fast)	Normal			
				Interval(10 - 60min)	10min			
			Heat pump thermo diff.adjust	On/Off *7	On			
		Lower limit(-9 - -1°C)		-5°C				
		Upper limit(+3 - +5°C)		5°C				
		Freeze stat function *12		Outdoor ambient temp. (3 - 20°C) / **	5°C			
		Simultaneous operation (DHW/Heating)		On/Off *7	Off			
				Outdoor ambient temp. (-30 - +10°C) *4	-15°C			
	Cold weather function		On/Off *7	Off				
			Outdoor ambient temp. (-30 - -10°C) *4	-15°C				
	Boiler operation		Hybrid settings	Outdoor ambient temp. (-30 - +10°C) *4	-15°C			
				Priority mode (Ambient/ Cost/CO2) *17	Ambient			
			Intelligent settings	Energy price *10	Electricity (0.001 - 999 */kWh)	0.5 */kWh		
					Boiler (0.001 - 999 */kWh)	0.5 */kWh		
				CO2 emission	Electricity (0.001 - 999 kg -CO2/kWh)	0.5 kg -CO2/kWh		
					Boiler (0.001 - 999 kg -CO2/ kWh)	0.5 kg -CO2/kWh		
			Heat source	Heat pump capacity (1 - 40 kW)	11.2 kW			
				Boiler efficiency (25 - 150%)	80%			
				Booster heater 1 capacity (0 - 30 kW)	2 kW			
				Booster heater 2 capacity (0 - 30 kW)	4 kW			
	Floor dry up function		On/Off *7	Off				
			Target temp.	Start&Finish (25 - 60°C)	30°C			
				Max. temp. (25 - 60°C)	45°C			
				Max. temp. period (1 - 20 days)	5 days			
			Flow temp. (Increase)	Temp. increase step (+1 - +10°C)	+5°C			
				Increase interval (1 - 7 days)	2 days			
	Flow temp. (Decrease)	Temp. decrease step (-1 - -10°C)	-5°C					
		Decrease interval (1 - 7 days)	2 days					
	Energy monitor settings	Electric heater capacity	Booster heater 1 capacity	0 - 30kW	2kW			
Booster heater 2 capacity			0 - 30kW	4kW				
Immersion heater capacity			0 - 30kW	0kW				
Delivered energy adjustment		-50 - +50%	0%					
Water pump input		Pump 1	0 - 200W or ***(factory fitted pump)	***				
		Pump 2	0 - 200W	0W				
		Pump 3	0 - 200W	0W				
Electric energy meter		0.1/1/10/100/1000 pulse/kWh	1 pulse/kWh					
Heat meter		0.1/1/10/100/1000 pulse/kWh	1 pulse/kWh					
External input settings	Demand control (IN4)		Heat source OFF/Boiler operation	Boiler operation				
	Outdoor thermostat (IN5)		Heater operation/Boiler operation	Boiler operation				

*7 On: the function is active; Off: the function is inactive.

*8 When DIP SW1-1 is set to OFF "WITHOUT Boiler" or SW2-6 is set to OFF "WITHOUT Mixing tank", neither Boiler nor Hybrid can be selected.

*9 Valid only when operating in Room temp. control mode.

*10 *** of */kWh represents currency unit (e.g. € or £ or the like)

*11 Valid only when operating in Heating room temperature.

*12 If asterisk (**) is chosen freeze stat function is deactivated. (i.e. primary water freeze risk)

*13 The settings related to Zone2 can be switched only when 2-zone temperature control or 2-Zone valve ON/OFF control is active.

14 Cooling mode settings are available for ERST20 model only.

*15 When DIP SW5-2 is set to OFF, the function is active.

*16 When the cylinder unit is connected with a PUMY-P outdoor unit, the mode is fixed to "Normal".

*17 When the cylinder unit is connected with a PUMY-P outdoor unit, the mode is fixed to "Ambient".

*18 When the cylinder unit/hydrobox is connected with a PUMY outdoor unit; To conduct a simultaneous operation of ATA heating and ATW space heating, set the minimum flow temperature above 45°C.

8.2 Hydrobox

The indoor hydrobox must be serviced **once a year** by a qualified individual. Servicing and maintenance of the outdoor unit should only be done by a Mitsubishi Electric trained technician with relevant qualifications and experience. Any electrical work should be done by a tradesperson with the appropriate electrical qualifications. Any maintenance or 'DIY' fixes done by a non-accredited person could invalidate the Warranty and/or result in damage to the hydrobox and injury to the person.

Basic Troubleshooting for Hydrobox

No.	Fault symptom	Possible cause	Explanation - Solution
1	Main remote controller display is blank.	<ol style="list-style-type: none"> There is no power supply to main remote controller. Power is supplied to main remote controller, however, the display on the main remote controller does not appear. 	<ol style="list-style-type: none"> Check LED2 on FTC. (See 3.2.1 Wiring Diagrams.) <ol style="list-style-type: none"> When LED2 is lit. Check for damage or contact failure of the main remote controller wiring. When LED2 is blinking. Refer to No. 5 below. When LED2 is not lit. Refer to No. 4 below. Check the following: <ul style="list-style-type: none"> Disconnection between the main remote controller cable and the FTC control board Failure of the main remote controller if "Please Wait" is not displayed. Refer to No. 2 below if "Please Wait" is displayed.
2	"Please Wait" remains displayed on the main remote controller.	<ol style="list-style-type: none"> "Please Wait" is displayed for up to 6 minutes. Communication failure between the main remote controller and FTC. Communication failure between FTC and outdoor unit. 	<ol style="list-style-type: none"> Normal operation. 3. Main remote controller start up checks/procedure. <ol style="list-style-type: none"> If "0%" or "50-99%" is displayed below "Please Wait" there is a communication error between the main remote controller and the FTC control board. <ul style="list-style-type: none"> Check wiring connections on the main remote controller. Replace the main remote controller or the FTC control board. If "1-49%" is displayed there is a communication error between the outdoor unit's and FTC's control boards. <ul style="list-style-type: none"> Check the wiring connections on the outdoor unit control board and the FTC control board. (Ensure S1 and S2 are not cross-wired and S3 is securely wired with no damage. (See 3.2.5 Electrical Connection.) Replace the outdoor unit's and/or the FTC's control boards.
3	The main screen appears with a press of the "ON" button, but disappears in a second.	The main remote controller operations do not work for a while after the settings are changed in the service menu. This is because the system takes time to apply the changes.	Normal operation. The indoor unit is applying updated settings made in the service menu. Normal operation will start shortly.
4	LED2 on FTC is off. (See 3.2.1 Wiring Diagrams.)	When LED1 on FTC is also off. (See 3.2.1 Wiring Diagrams.) <FTC powered via outdoor unit.> <ol style="list-style-type: none"> The outdoor unit is not supplied at the rated voltage. Defective outdoor controller circuit board. FTC is not supplied with 220 to 240V AC. FTC failure. Faulty connector wiring. 	<ol style="list-style-type: none"> Check the voltage across the terminals L and N or L3 and N on the outdoor power board. (See 3.2.5 Electrical Connection.) <ul style="list-style-type: none"> When the voltage is not 220 to 240V AC, check wiring of the outdoor unit and of the breaker. When the voltage is at 220 to 240V AC, go to "2." below. Check the voltage across the outdoor unit terminals S1 and S2. (See 3.2.5 Electrical Connection.) <ul style="list-style-type: none"> When the voltage is not 220 to 240V AC, check the fuse on the outdoor control board and check for faulty wiring. When the voltage is 220 to 240V AC, go to "3." below. Check the voltage across the indoor unit terminals S1 and S2. (See 3.2.5 Electrical Connection.) <ul style="list-style-type: none"> When the voltage is not 220 to 240V AC, check FTC-outdoor unit wiring for faults. When the voltage is 220 to 240V AC, go to "4." below. Check the FTC control board. <ul style="list-style-type: none"> Check the fuse on FTC control board. Check for faulty wiring. If no problem found with the wiring, the FTC control board is faulty. Check the connector wiring. <ul style="list-style-type: none"> When the connectors are wired incorrectly, re-wire the connectors referring to below. (See 3.2.5 Electrical Connection.)

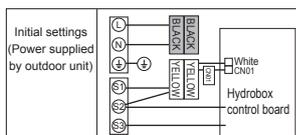

Cylinder / Hydrobox

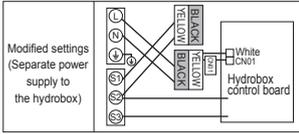
No.	Fault symptom	Possible cause	Explanation - Solution
4	LED2 on FTC is off. (See 3.2.1 Wiring Diagrams.)	<FTC powered on independent source> 1. FTC is not supplied with 220 to 240V AC. 2. There are problems in the method of connecting the connectors. 3. FTC failure	1. Check the voltage across the L and N terminals on the indoor power supply terminal block. (See 3.2.5 Electrical Connection.) <ul style="list-style-type: none"> • When the voltage is not 220 to 240V AC, check for faulty wiring to power supply. • When the voltage is 220 to 240V AC, go to 2. below. 2. Check for faulty wiring between the connectors. <ul style="list-style-type: none"> • When the connectors are wired incorrectly re-wire them correctly referring to below. (See 3.2.5 Electrical Connection and a wiring diagram on the control and electrical box cover.)  <ul style="list-style-type: none"> • If no problem found with the wiring, go to 3. below. 3. Check the FTC control board. <ul style="list-style-type: none"> • Check the fuse on FTC control board. • Check for faulty wiring. • If no problem found with the wiring, the FTC control board is faulty.
		When LED1 on FTC is lit. Incorrect setting of refrigerant address for outdoor unit. (None of the refrigerant address is set to "0".)	Recheck the refrigerant address setting on the outdoor unit. Set the refrigerant address to "0". (Set refrigerant address using SW1(3 - 6) on outdoor controller circuit board.)
5	LED2 on FTC is blinking. (See 3.2.1 Wiring Diagrams.)	When LED1 is also blinking on FTC . Faulty wiring between FTC and outdoor unit	Check for faulty wiring between FTC and outdoor unit.
		When LED1 on FTC is lit. 1. Faulty wiring in main remote controller Multiple indoor units have been wired to a single outdoor unit. 2. Short-circuited wiring in main remote controller 3. Main remote controller failure	1. Check for faulty wiring in main remote controller. The number of indoor units that can be wired to a single outdoor unit is one. Additional indoor units must be wired individually to a single outdoor unit. 2,3. Remove main remote controller wires and check LED2 on FTC. (See Figure 3.2.3.) <ul style="list-style-type: none"> • If LED2 is blinking check for short circuits in the main remote controller wiring . • If LED2 is lit, wire the main remote controller again and: <ul style="list-style-type: none"> - if LED2 is blinking, the main remote controller is faulty; - if LED2 is lit, faulty wiring of the main remote controller has been corrected.
6	LED4 on FTC is off. (See 3.2.1 Wiring Diagrams)	1. SD memory card is NOT inserted into the memory card slot with correct orientation. 2. Not an SD standards compliant memory card.	1. Correctly insert SD memory card in place until a click is heard. 2. Use an SD standards compliant memory card. (Refer to section 3.3 Using SD memory card.)
	LED4 on FTC is blinking. (See 3.2.1 Wiring Diagrams)	1. Full of data. 2. Write-protected. 3. NOT formatted. 4. Formatted in NTFS file system.	1. Move or delete data, or replace SD memory card with a new one. 2. Release the write-protect switch. 3. Refer to 3.3 Using SD memory card. 4. FTC is Not compatible with NTFS file system. Use an SD memory card formatted in FAT file system.
7	No water at hot tap.	1. Cold main off 2. Strainer (local supply) blocked.	1. Check and open stop cock. 2. Isolate water supply and clean strainer.
8	Cold water at tap.	1. Hot water run out. 2. Prohibit, schedule timer or holiday mode selected or demand control input (IN4) or smart grid ready (switch-off command). 3. Heat pump not working. 4. Booster heater cut-out tripped. 5. The earth leakage circuit breaker for booster heater breaker (ECB1) tripped. 6. The booster heater thermal cut-out has tripped and cannot be reset using the manual reset button. 7. Immersion heater cut-out tripped. 8. Immersion heater breaker (ECB2) tripped. 9. 3-way valve fault	1. Ensure DHW mode is operating and wait for DHW tank to re-heat. 2. Check settings and change as appropriate. 3. Check heat pump – consult outdoor unit service manual. 4. Check booster heater thermostat and press reset button if safe. Reset button is located on the side of booster heater, covered with white rubber cap. See 4. PART NAMES AND FUNCTIONS in Service Handbook or 3. Technical Parts in Installation Manual to find out its position. 5. Check the cause and reset if safe. 6. Check resistance across the thermal cut-out, if open then the connection is broken and the booster heater will have to be replaced. Contact your Mitsubishi Electric dealer. 7. Check immersion heater thermostat and press reset button, located on immersion heater boss, if safe. If the heater has been operated with no water inside it may have failed, so please replace it with a new one. 8. Check the cause and reset if safe. 9. Check plumbing/wiring to 3-way valve. <ul style="list-style-type: none"> (i) Manually override 3-way valve using the main remote controller. (Refer to <Manual operation> in section 6. System Set Up) If the valve does not still function, go to (ii) below. (ii) Replace 3-way valve.

No.	Fault symptom	Possible cause	Explanation - Solution
9	Water heating takes longer.	<ol style="list-style-type: none"> Heat pump not working. Booster heater cut-out tripped. Booster heater breaker (ECB1) tripped. The booster heater thermal cut-out has tripped and cannot be reset using the manual reset button. Immersion heater cut-out has been triggered. Immersion heater breaker (ECB2) tripped. 	<ol style="list-style-type: none"> Check heat pump – consult outdoor unit service manual. Check booster heater thermostat and press reset button if safe. Reset button is located on the side of booster heater, covered with white rubber cap. See 4. PART NAMES AND FUNCTIONS in Service Handbook or 3. Technical Parts in Installation Manual to find out its position. Check the cause and reset if safe. Check resistance across the thermal cut-out, if open then connection is broken and the booster heater will have to be replaced. Contact your Mitsubishi Electric dealer. Check immersion heater thermostat and press reset button if safe. If the heater kept running with no water inside, this may have resulted in failure, so replace it with a new one. Check the cause and reset if safe.
10	Temperature of DHW tank water dropped.	<p>When DHW operation is not running, the DHW tank emits heat and the water temperature decreases to a certain level. If water in the DHW tank is reheated frequently because of a significant drop in water temperature, check for the following.</p> <ol style="list-style-type: none"> Water leakage in the pipes that connect to the DHW tank Insulation material coming loose or off. 3-way valve failure 	<ol style="list-style-type: none"> Take the following measures. <ul style="list-style-type: none"> Retighten the nuts holding the pipes onto the DHW tank. Replace seal materials. Replace the pipes. Fix insulation. Check plumbing/wiring to 3-way valve. <ol style="list-style-type: none"> Manually override 3-way valve using the main remote controller. (Refer to <Manual operation> in section 7. System Set Up) If the valve does not still function, go to (ii) below. Replace 3-way valve.
11	Hot or warm water from cold tap.	Heat of hot water pipe is transferred to cold water pipe.	Insulate/re-route pipework.
12	Water leakage	<ol style="list-style-type: none"> Poorly sealed connections of water circuit components Water circuit components reaching the end of life 	<ol style="list-style-type: none"> Tighten connections as required. Refer to PARTS CATALOG in the service manual for expected part lifetimes and replace them as necessary.
13	Heating system does not reach the set temperature.	<ol style="list-style-type: none"> Prohibit, schedule timer or holiday mode selected or demand control input (IN4) or smart grid ready (switch-off command). Check settings and change as appropriate. The temperature sensor is located in a room that has a different temperature relative to that of the rest of the house. Heat pump not working. Booster heater cut-out tripped. Booster heater breaker (ECB1) tripped. The booster heater thermal cut-out tripped and can not be reset using the manual reset button. Incorrectly sized heat emitter. 3-way valve failure Battery problem (*wireless control only) If a mixing tank is installed, the flow rate between the mixing tank and the hydrobox is less than that between the mixing tank and the local system. 	<ol style="list-style-type: none"> Check settings and change as appropriate. Check the battery power and replace if flat. Relocate the temperature sensor to a more suitable room. Check heat pump – consult outdoor unit service manual. Check booster heater thermostat and press reset button if safe. Reset button is located on the side of booster heater, covered with white rubber cap. (See 4. PART NAMES AND FUNCTIONS in Service Handbook or 3. Technical Parts in Installation Manual to find out its position.) Check the cause of the trip and reset if safe. Check resistance across the thermal cut-out, if open then the connection is broken and the booster heater will have to be replaced. Contact your Mitsubishi Electric dealer. Check the heat emitter surface area is adequate. Increase size if necessary. Check plumbing/wiring to 3-way valve. Check the battery power and replace if flat. Increase the flow rate between the mixing tank and the hydrobox decrease that between the mixing tank and the local system.

No.	Fault symptom	Possible cause	Explanation - Solution
14	In 2-zone temperature control, only Zone2 does not reach the set temperature.	<ol style="list-style-type: none"> When Zone1 and Zone2 are both in heating mode, the hot water temperature in Zone2 does not exceed that in Zone1. Faulty wiring of motorized mixing valve Faulty installation of motorized mixing valve Incorrect setting of Running time Motorized mixing valve failure 	<ol style="list-style-type: none"> Normal action no action necessary. See 3.5 Wiring for 2-zone temperature control. Check for correct installation. (Refer to the manual included with each motorized mixing valve.) Check for correct setting of Running time. Inspect the mixing valve. (Refer to the manual included with each motorized mixing valve.)
15	When a PUHZ-FRP outdoor unit is connected, DHW or Heating operation cannot run.	The outdoor unit is set to have operation of the indoor unit of air conditioner take precedence over that of the hydrobox, and in the main remote controller settings "Electric heater (Heating)" or "Electric heater (DHW)" is turned off.	Turn ON Electric heater (Heating) or Electric heater (DHW) using the main remote controller.
16	When a PUHZ-FRP outdoor unit is connected and is in heat recovery operation, the set temperature is not reached.	When the outdoor unit is set to have cooling operation of the indoor unit of air conditioner take precedence over that of the hydrobox, the outdoor unit controls the frequency of the compressor according to the load of air conditioner. The DHW and heating run according to that frequency.	Normal operation no action necessary. If Air-to-Water system is given priority in operation, comp Hz can be regulated depending on the load of DHW or Heating. For more details, refer to the PUHZ-FRP installation manual.
17	After DHW operation room temperature rises slightly.	At the end of the DHW mode operation the 3-way valve diverts hot water away from the DHW circuit into space heating circuit. This is done to prevent the hydrobox components from overheating. The amount of hot water directed into the space heating circuit varies according to the type of the system and of the pipe run between the plate heat exchanger and the hydrobox.	Normal operation no action necessary.
18	The room temperature rises during DHW operation.	3-way valve failure	Check the 3-way valve.
19	Water discharges from pressure relief valve. (Primary circuit)	<ol style="list-style-type: none"> If continual – pressure relief valve may be damaged. If intermittent – expansion vessel charge may have reduced/bladder perished. 	<ol style="list-style-type: none"> Turn the handle on the pressure relief valve to check for foreign objects in it. If the problem is not still solved, replace the pressure relief valve with a new one. Check pressure in expansion vessel. Recharge to 1 bar if necessary. If bladder perished replace expansion vessel with a new one.
20	Water discharges from pressure relief valve (field supplied item). (Sanitary circuit)	<ol style="list-style-type: none"> If continual – field supplied pressure reducing valve not working. If continual – pressure relief valve seat may be damaged. If intermittent – expansion vessel charge may have reduced/bladder perished. DHW tank may have subjected to backflow. 	<ol style="list-style-type: none"> Check function of pressure reducing valve and replace if necessary. Turn the handle on the pressure relief valve to check for foreign objects inside. If the problem is not still solved, replace the pressure relief valve. Check gas-side pressure in expansion vessel. Recharge to correct precharge pressure if necessary. If bladder perished replace expansion vessel with a new one with appropriate pre-charge. Check the pressure in DHW tank. If pressure in DHW tank is similar to that in the incoming mains, cold water supply that merges with incoming mains water supply could flow back to DHW tank. Investigate source of back-feed and rectify error in pipework/fitting configuration. Adjust pressure in cold supply.
21	Noisy water circulation pump	Air in water circulation pump .	Use manual and automatic air vents to remove air from system. Top up water if necessary to achieve 1 bar on primary circuit.
22	Noise during hot water draw off typically worse in the morning.	<ol style="list-style-type: none"> Loose airing cupboard pipework. Heaters switching on/off. 	<ol style="list-style-type: none"> Install extra pipe fastening clips. Normal operation no action necessary.
23	Mechanical noise heard coming from the hydrobox.	<ol style="list-style-type: none"> Heaters switching on/off. 3-way valve changing position between DHW and heating mode. 	Normal operation no action necessary.
24	Water circulation pump runs for a short time unexpectedly .	Water circulation pump jam prevention mechanism (routine) to inhibit the build-up of scale.	Normal operation no action necessary.
25	Milky/Cloudy water (Sanitary circuit)	Oxygenated water	Water from any pressurised system will release oxygen bubbles when water is running. The bubbles will settle out.
26	Heating mode has been on standby for a long time (does not start operation smoothly.)	The time of "Delay" set in "Economy settings for pump" is too short. (Go to "Service menu" → "Auxiliary settings" → "Economy settings for pump").	Increase the time of "Delay" in "Economy settings for pump" .

No.	Fault symptom	Possible cause	Explanation - Solution																
27	The hydrobox that was running in the heating mode before power failure is running in the DHW mode after power recovery.	The hydrobox is designed to run in an operation mode with a higher priority (i.e. DHW mode in this case) at power recovery.	<ul style="list-style-type: none"> Normal operation. After the DHW max. operation time has elapsed or the DHW max. temperature has been reached, the DHW mode switches to the other mode (ex. Heating mode). 																
28	Cooling mode is NOT available.	DIP SW2-4 is OFF.	Turn DIP SW2-4 to ON. (Refer to 3.2.2 and 3.2.3 DIP switch functions.)																
29	The cooling system does not cool down to the set temperature.	<ol style="list-style-type: none"> When the water in the circulation circuit is unduly hot, Cooling mode starts with a delay for the protection of the outdoor unit. When the outdoor ambient temperature is lower than the preset temperature that activates the freeze stat function, Cooling mode does not start running. 	<ol style="list-style-type: none"> Normal operation. To run Cooling mode overriding the freeze stat function, adjust the preset temperature that activates the freeze stat function. (Refer to <Freeze stat function> in section 7. System Set Up.) 																
30	The electric heaters are activated shortly after DHW or LP mode starts running after Cooling mode.	The setting time period of Heat-pump-only operation is short.	Adjust the setting time period of Heat-pump only operation. (Refer to <Electric heater (DHW)> in section 7. System Set Up.)																
31	During DHW or LP mode following the cooling mode, error L6 (circulation water freeze protection error) occurs and the system stops all the operations.	The unit runs in Cooling mode when the outdoor ambient temperature is lower than 10°C (outside of the guaranteed operating range). When defrosting operation is running at such a low outdoor ambient temperature after Cooling mode is switched to DHW or LP mode, the water temperature in the cooling circuit drops too low, which could result in L6 error to stop all the operations.	Do not run Cooling operation when the outdoor ambient temperature is lower than 10°C. To automatically stop or recover only Cooling operation and keep other operations running, the freeze stat function can be used. Set the preset temperature that activates the freeze stat function to adjust the outdoor ambient temperature as follows. (Refer to <Freeze stat function> in section 7. System Set Up.) <table border="1" style="margin-top: 10px;"> <thead> <tr> <th>Outdoor ambient temperature</th> <th>Cooling operation</th> </tr> </thead> <tbody> <tr> <td>3°C higher than the preset temperature</td> <td>Stop</td> </tr> <tr> <td>5°C higher than the preset temperature</td> <td>Recover</td> </tr> </tbody> </table>	Outdoor ambient temperature	Cooling operation	3°C higher than the preset temperature	Stop	5°C higher than the preset temperature	Recover										
Outdoor ambient temperature	Cooling operation																		
3°C higher than the preset temperature	Stop																		
5°C higher than the preset temperature	Recover																		
32	The energy monitor value seems not correct. Note: There could be some discrepancies between the actual and the calculated values. If you seek for accuracy, please make sure to connect power meter(s) and heat meter to FTC board. Both should be locally supplied.	<ol style="list-style-type: none"> Incorrect setting of the energy monitor Non-connectable type of external meter (local supply) is connected. External meter (local supply) failure FTC board failure 	<ol style="list-style-type: none"> Check the setting by following the procedure below. (1) Check if the DIP switch is set as the table below. <table border="1" style="margin-top: 5px;"> <thead> <tr> <th colspan="2">Consumed electric energy</th> <th colspan="2">Delivered heat energy</th> </tr> </thead> <tbody> <tr> <td>SW3-4</td> <td>Electric energy meter (Local supply)</td> <td>SW3-8</td> <td>Heat meter (Local supply)</td> </tr> <tr> <td>OFF</td> <td>Without</td> <td>OFF</td> <td>Without</td> </tr> <tr> <td>ON</td> <td>With</td> <td>ON</td> <td>With</td> </tr> </tbody> </table> (2) In the case external electric energy meter and/or heat meter is not used, check if the setting for electric heater and water pump(s) input is correct by referring to <Energy monitor setting> in section 6. System Set Up. (3) In the case external electric energy meter and/or heat meter is used, check if the unit of output pulse on external meter matches with the one set at the main remote controller by referring to <Energy monitor setting> in section 6. System Set Up. 2. Check if the external meter (local supply) is connectable type by referring to <Energy monitor setting> in section 7. System Set Up. 3. Check if signal is sent to IN8 to IN10 properly. (Refer to section 3.2.1 Wiring Diagrams) Replace the external heat meter if defective. 4. Check the FTC control board. <ul style="list-style-type: none"> Check for faulty wiring. If no problem found with the wiring, the FTC control board is faulty. Replace the board. 	Consumed electric energy		Delivered heat energy		SW3-4	Electric energy meter (Local supply)	SW3-8	Heat meter (Local supply)	OFF	Without	OFF	Without	ON	With	ON	With
Consumed electric energy		Delivered heat energy																	
SW3-4	Electric energy meter (Local supply)	SW3-8	Heat meter (Local supply)																
OFF	Without	OFF	Without																
ON	With	ON	With																
33	Heat pump is forced to turn ON and OFF.	Smart grid ready input (IN11 and IN12) is used, and switch-on and off commands are input.	Normal operation no action necessary.																

■ Annual Maintenance

It is essential that the hydrobox is serviced at least once a year by a qualified individual any spare parts required MUST be purchased from Mitsubishi Electric (safety matter). **NEVER** bypass safety devices or operate the unit without them being fully operational.

Annual Maintenance Log Book

Contractor name		Engineer name	
Site name		Site number	
Hydrobox maintenance record sheet			
Warranty number		Model number	
		Serial number	
No.	Mechanical	Frequency	Notes
1	Isolate and drain hydrobox, remove mesh from internal strainer clean and replace.		
2	Open the pressure relief valve, check for unrestricted discharge to the tundish and that the valve reseats correctly. Check there are no blockages in the tundish and associated pipe work.		
3	Drop the primary/heating system pressure to zero check and if necessary top up the expansion relief vessel (1 bar). Air valve of expansion vessel is TR-412.		
4	Check and if necessary top up the concentration of anti-freeze/inhibitor (if used in the system).		
5	Top up the primary/heating system using an appropriate filling loop and re-pressurise to 1 bar.		
6	Heat system and check pressure does not rise above 3 bar and no water is released from the safety valves.		
7	Release any air from the system.		
Refrigerant models only [EXCEPT EHPX]		Frequency	Notes
1	Refer to outdoor unit manual.		
Electrical		Frequency	Notes
1	Check condition of cables.		
2	Check rating and fuse fitted on the electricity supply.		
Controller		Frequency	Notes
1	Check field settings against factory recommendations.		
2	Check battery power of wireless thermostat and replace if necessary.		
Outdoor heat pump unit maintenance record sheet			
Model number		Serial number	
	Mechanical	Frequency	Notes
1	Inspect grill, heat exchanger fins and air inlet for trapped debris/damage.		
2	Check condensate drain provision.		
3	Check integrity of water pipe work and insulation.		
4	Check all electrical connections.		
5	Check and record the operation voltage.		

* All the above checks should be carried out once a year.

Note:

Within the first couple of months of installation, remove and clean the hydrobox's strainer mesh plus any that are fitted external to the hydrobox. This is especially important when installing on an existing system.

In addition to annual servicing it is necessary to replace or inspect some parts after a certain period of system operation. Please see tables below for detailed instructions. Replacement and inspection of parts should always be done by a competent person with relevant training and qualifications.

Parts which require regular replacement

Parts	Replace every	Possible failures
Pressure relief valve (PRV) Air vent (Auto/Manual) Drain cock (Primary circuit) Manometer	6 years	Water leakage

Parts which require regular inspection

Parts	Check every	Possible failures
Water circulation pump	20,000 hrs (3 years)	Water circulation pump failure

Parts which must NOT be reused when servicing

- * O-ring
- * Gasket

Note:

Always replace the gasket for pump with a new one at each regular maintenance (every 20,000 hours of use or every 3 years).

■ Error Codes

Code	Error	Action
L3	Circulation water temperature overheat protection	Flow rate may be reduced check for; <ul style="list-style-type: none"> • Water leakage • Strainer blockage • Water circulation pump function (Error code may display during filling of primary circuit, complete filling and reset error code.)
L4	DHW tank water temperature overheat protection	Check the immersion heater and it's contactor.
L5	Indoor unit temperature thermistor (THW1, THW2, THW5, THW6, THW7, THW8, THW9) failure	Check resistance across the thermistor.
L6	Circulation water freeze protection	See Action for L3.
L8	Heating operation error	Re-attach any thermistors that have become dislodged.
L9	Low primary circuit flow rate detected by flow sensor or flow switch (flow switches 1, 2, 3)	See Action for L3. If the flow sensor or flow switch itself does not work, replace it. Caution: The pump valves may be hot, please take care.
LC	Boiler circulation water temperature overheat protection	Check if the setting temperature of the Boiler for heating exceeds the restriction. (See the manual of the thermistors "PAC-TH011HT-E") Flow rate of the heating circuit from the boiler may be reduced. Check for <ul style="list-style-type: none"> • water leakage • strainer blockage • water circulation pump function
LD	Boiler temperature thermistor (THWB1, THWB2) failure	Check resistance across the thermistor.
LE	Boiler operation error	See Action for L8. Check the status of the boiler.
LF	Flow sensor failure	Check flow sensor cable for damage or loose connections.
LH	Boiler circulation water freeze protection	Flow rate of the heating circuit from the boiler may be reduced. Check for <ul style="list-style-type: none"> • water leakage • strainer blockage • water circulation pump function
LJ	DHW operation error (type of external plate HEX)	<ul style="list-style-type: none"> • Check for disconnection of DHW tank water temp. thermistor (THW5). • Flow rate of the sanitary circuit may be reduced. • Check for water circulation pump function.
LL	Setting errors of DIP switches on FTC control board	For boiler operation, check that DIP SW1-1 is set to ON (With Boiler) and DIP SW2-6 is set to ON (With Mixing Tank). For 2-zone temperature control, check DIP SW2-7 is set to ON (2-zone) and DIP SW2-6 is set to ON (With Mixing Tank).
J0	Communication failure between FTC and wireless receiver	Check connection cable for damage or loose connections.
P1	Thermistor (Room temp.) (TH1) failure	Check resistance across the thermistor.
P2	Thermistor (Ref. liquid temp.) (TH2) failure	Check resistance across the thermistor.
P6	Anti-freeze protection of plate heat exchanger	See Action for L3. Check for correct amount of refrigerant.
J1 - J8	Communication failure between wireless receiver and wireless remote controller	Check wireless remote controller's battery is not flat. Check the pairing between wireless receiver to wireless remote controller. Test the wireless communication. (See the manual of wireless system)
E0 - E5	Communication failure between main remote controller and FTC	Check connection cable for damage or loose connections.
E6 - EF	Communication failure between FTC and outdoor unit	Check that the outdoor unit has not been turned off. Check connection cable for damage or loose connections. Refer to outdoor unit service manual.
E9	Outdoor unit receives no signal from indoor unit.	Check both units are switched on. Check connection cable for damage or loose connections. Refer to outdoor unit service manual.
U*, F*	Outdoor unit failure	Refer to outdoor unit service manual.

Note: To cancel error codes please switch system off (Press button E, on the main remote controller, for 3 secs).

■ Engineers Forms (Hydrobox)

Should settings be changed from default, please enter and record new setting in 'Field Setting' column. This will ease resetting in the future should the system use change or the circuit board need to be replaced.

Commissioning/Field settings record sheet

Except for EHSE/ERSE series

Main remote controller screen		Parameters	Default setting	Field setting	Notes	
Main	Zone1 heating room temp.	10°C - 30°C	20°C			
	Zone2 heating room temp. *15	10°C - 30°C	20°C			
	Zone1 heating flow temp.	25°C - 60°C	45°C			
	Zone2 heating flow temp. *1	25°C - 60°C	35°C			
	Zone1 cooling flow temp. *13	5°C - 25°C	15°C			
	Zone2 cooling flow temp. *13	5°C - 25°C	20°C			
	Zone1 heating compensation curve	-9°C - + 9°C	0°C			
	Zone2 heating compensation curve *1	-9°C - + 9°C	0°C			
	Holiday mode	Active/Non active/Set time	—			
	Forced DHW operation	On/Off	—			
Option	DHW	On/Off/Timer	On			
	Heating/Cooling	On/Off/Timer	On			
	Energy monitor	Consumed electrical energy/Delivered energy	—			
Setting	DHW *14	Operation mode	Normal/Eco	Normal		
		DHW max. temp.	40°C - 60°C *2	50°C		
		DHW temp. drop	5°C - 30°C	10°C		
		DHW max. operation time	30 - 120 minutes	60 minutes		
		DHW mode restriction	30 - 120 minutes	30 minutes		
	Legionella prevention *14	Active	Yes/No	Yes		
		Hot water temp.	60°C - 70°C *2	65°C		
		Frequency	1 - 30 days	15 days		
		Start time	00.00 - 23.00	03.00		
		Max. operation time	1 - 5 hours	3 hours		
		Duration of maximum temp.	1 - 120 minutes	30 minutes		
		Heating/ Cooling *13	Zone1 operation mode	Heating room temp./ Heating flow temp./ Heating compensation curve/ Cooling flow temp.	Room temp.	
	Zone2 operation mode *1		Heating room temp./ Heating flow temp./ Heating compensation curve/ Cooling flow temp.	Compensation curve		
	Compensation curve	Hi flow temp. set point	Zone1 outdoor ambient temp.	-30°C - +33°C *3	-15°C	
			Zone1 flow temp.	25°C - 60°C	50°C	
			Zone2 outdoor ambient temp. *1	-30°C - +33°C *3	-15°C	
			Zone2 flow temp. *1	25°C - 60°C	40°C	
		Lo flow temp. set point	Zone1 outdoor ambient temp.	-28°C - +35°C *4	35°C	
			Zone1 flow temp.	25°C - 60°C	25°C	
			Zone2 outdoor ambient temp. *1	-28°C - +35°C *4	35°C	
Zone2 flow temp.			25°C - 60°C	25°C		
Adjust		Zone1 outdoor ambient temp.	-29°C - +34°C *5	—		
		Zone1 flow temp.	25°C - 60°C	—		
Holiday	DHW *14	Active/Non active	Non active			
	Heating/ Cooling *13	Active/Non active	Active			
	Zone1 heating room temp.	10°C - 30°C	15°C			
	Zone2 heating room temp. *15	10°C - 30°C	15°C			
	Zone1 heating flow temp.	25°C - 60°C	35°C			
	Zone2 heating flow temp. *1	25°C - 60°C	25°C			
	Zone1 cooling flow temp. *13	5°C - 25°C	25°C			
	Zone2 cooling flow temp. *13	5°C - 25°C	25°C			
	Initial settings	Language	EN/FR/DE/SV/ES/IT/DA/NL/FI/NO/PT/BG/PL/CZ/RU	EN		
		°C/°F	°C/°F	°C		
Summer time		On/Off	Off			
Temp. display		Room/DHW tank/Room&DHW tank /Off	Off			
Time display		hh:mm/hh:mm AM/AM hh:mm	hh:mm			
Room sensor settings for Zone1		TH1/Main RC/Room RC1-8/Time/Zone"	TH1			
Room sensor settings for Zone2 *1		TH1/Main RC/Room RC1-8/Time/Zone"	TH1			
Room RC zone select *1		Zone1/Zone2	Zone1			
Service menu	Thermistor adjustment	THW1	-10°C - +10°C	0°C		
		THW2	-10°C - +10°C	0°C		
		THW5	-10°C - +10°C	0°C		
		THW6	-10°C - +10°C	0°C		
		THW7	-10°C - +10°C	0°C		
		THW8	-10°C - +10°C	0°C		
		THW9	-10°C - +10°C	0°C		
		THWB1	-10°C - +10°C	0°C		
	Auxiliary settings	Economy settings for pump.	On/Off *7 Delay (3 - 60 min)	On 10 min		
		Electric heater (Heating)	Space heating: On (used)/Off (not used)	On		
			Electric heater delay timer (5 - 180 min)	30 min		
		Electric heater (DHW) *14	Booster heater	DHW: On (used)/Off (not used)	On	
			Immersion heater	DHW: On (used)/Off (not used)	On	
		Mixing valve control	Electric heater delay timer (15 - 30 min)	15 min		
			Running (10 - 240 seconds)	120 seconds		
		Flow sensor *6	Interval (1 - 30 min)	2 min		
			Minimum(0 - 100L/min)	5 L/min		
			Maximum(0 - 100L/min)	100 L/min		

*1 The settings related to Zone2 can be switched only when 2 Zone temperature control is enabled (when DIP SW2-6 and SW 2-7 are ON).

*2 For the model without both booster and immersion heater, it may not reach the set temperature depending on the outside ambient temperature.

*3 The lower limit is -15°C depending on the connected outdoor unit.

*4 The lower limit is -13°C depending on the connected outdoor unit.

*5 The lower limit is -14°C depending on the connected outdoor unit.

*6 Do not change the setting since it is set according to the specification of flow sensor attached to the hydrobox.

Engineers Forms

Commissioning/Field settings record sheet (continued from the previous page)

Except for EHSE/ERSE series

Main remote controller screen			Parameters	Default setting	Field setting	Notes		
Service menu	Pump speed		Pump speed(1 - 5)	5				
	Heat source setting		Standard/Heater/Boiler/Hybrid *8	Standard				
	Operation settings	Heating operation *9	Flow temp.range *11	Min.temp.(25 - 45°C) *17 Max.temp.(35 - 60°C)	30°C 50°C			
			Room temp.control *16	Mode(Normal/Fast) Interval(10 - 60min)	Normal 10min			
			Heat pump thermo diff.adjust	On/Off *7	On			
				Lower limit(-9 - -1°C)	-5°C			
			Upper limit(+3 - +5°C)	5°C				
	Freeze stat function *12		Outdoor ambient temp. (3 - 20°C) / **	5°C				
	Simultaneous operation (DHW/ Heating)		On/Off *7	Off				
			Outdoor ambient temp. (-30 - +10°C) *4	-15°C				
	Cold weather function		On/Off *7	Off				
			Outdoor ambient temp. (-30 - -10°C) *4	-15°C				
	Boiler operation		Hybrid settings	Outdoor ambient temp. (-30 - +10°C) *4	-15°C			
				Priority mode (Ambient/ Cost/CO2)	Ambient			
			Intelligent settings	Energy price *10	Electricity (0.001 - 999 */kWh)	0.5 */kWh		
					Boiler (0.001 - 999 */kWh)	0.5 */kWh		
			CO2 emission	Electricity (0.001 - 999 kg -CO2/kWh)	0.5 kg -CO2/kWh			
					Boiler (0.001 - 999 kg -CO2/kWh)	0.5 kg -CO2/kWh		
			Heat source	Heat pump capacity (1 - 40 kW)	11.2 kW			
				Boiler efficiency (25 - 150%)	80%			
				Booster heater 1 capacity (0 - 30 kW)	2 kW			
				Booster heater 2 capacity (0 - 30 kW)	4 kW			
	Floor dry up function		On/Off *7	Off				
			Target temp.	Start&Finish (25 - 60°C)	30°C			
				Max. temp. (25 - 60°C)	45°C			
				Max. temp. period (1 - 20 days)	5 days			
			Flow temp. (Increase)	Temp. increase step (+1 - +10°C)	+5°C			
				Increase interval (1 - 7 days)	2 days			
	Flow temp. (Decrease)	Temp. decrease step (-1 - -10°C)	-5°C					
		Decrease interval (1 - 7 days)	2 days					
	Energy monitor settings		Electric heater capacity	Booster heater 1 capacity	0 - 30kW	2kW		
				Booster heater 2 capacity	0 - 30kW	4kW		
				Immersion heater capacity	0 - 30kW	0kW		
Delivered energy adjustment			-50 - +50%	0%				
Water pump input	Pump 1	0 - 200W or ***(factory fitted pump)	***					
	Pump 2	0 - 200W	0W					
	Pump 3	0 - 200W	0W					
Electric energy meter	0.1/1/10/100/1000 pulse/kWh	1 pulse/kWh						
Heat meter	0.1/1/10/100/1000 pulse/kWh	1 pulse/kWh						
External input settings		Demand control (IN4)	Heat source OFF/Boiler operation	Boiler operation				
		Outdoor thermostat (IN5)	Heater operation/Boiler operation	Boiler operation				

*7 On: the function is active; Off: the function is inactive.

*8 When DIP SW1-1 is set to OFF "WITHOUT Boiler" or SW2-6 is set to OFF "WITHOUT Mixing tank", neither Boiler nor Hybrid can be selected.

*9 Valid only when operating in Room temp. control mode.

10 "" of */kWh" represents currency unit (e.g. € or £ or the like)

*11 Valid only when operating in Heating room temperature.

*12 If asterisk (**) is chosen freeze stat function is deactivated. (i.e. primary water freeze risk)

13 Cooling mode settings are available for ERS model only.

*14 Only available if DHW tank present in system.

*15 The settings related to Zone2 can be switched only when 2-zone temperature control or 2-zone valve ON/OFF control is active.

*16 When DIP SW5-2 is set to OFF, the function is active.

*17 When the cylinder unit/hydrobox is connected with a PUMY outdoor unit; To conduct a simultaneous operation of ATA heating and ATW space heating, set the minimum flow temperature above 45°C.

Engineers Forms (Hydrobox)

Should settings be changed from default, please enter and record new setting in 'Field Setting' column. This will ease resetting in the future should the system use change or the circuit board need to be replaced.

Commissioning/Field settings record sheet

EHSE/ERSE series

Main remote controller screen		Parameters		Default setting	Field setting	Notes	
Main	Zone1 heating room temp.		10°C - 30°C	20°C			
	Zone2 heating room temp. *15		10°C - 30°C	20°C			
	Zone1 heating flow temp.		25°C - 60°C	45°C			
	Zone2 heating flow temp. *1		25°C - 60°C	35°C			
	Zone1 cooling flow temp. *13		5°C - 25°C	15°C			
	Zone2 cooling flow temp. *13		5°C - 25°C	20°C			
	Zone1 heating compensation curve		-9°C - + 9°C	0°C			
	Zone2 heating compensation curve *1		-9°C - + 9°C	0°C			
	Holiday mode		Active/Non active/Set time	—			
Option	Forced DHW operation		On/Off	—			
	DHW		On/Off/Timer	On			
	Heating/Cooling		On/Off/Timer	On			
	Energy monitor		Consumed electrical energy/Delivered energy	—			
Setting	DHW *14	Operation mode		Normal/Eco	Normal		
		DHW max. temp.		40°C - 60°C *2	50°C		
		DHW temp. drop		5°C - 30°C	10°C		
		DHW max. operation time		30 - 120 minutes	60 minutes		
		DHW mode restriction		30 - 120 minutes	30 minutes		
		Legionella prevention *14		Active	Yes/No	Yes	
			Hot water temp.		60°C - 70°C *2	65°C	
			Frequency		1 - 30 days	15 days	
			Start time		00.00 - 23.00	03.00	
			Max. operation time		1 - 5 hours	3 hours	
			Duration of maximum temp.		1 - 120 minutes	30 minutes	
	Heating/ Cooling *13		Zone1 operation mode		Heating room temp./ Heating flow temp./ Heating compensation curve/ Cooling flow temp.	Room temp.	
			Zone2 operation mode *1		Heating room temp./ Heating flow temp./ Heating compensation curve/ Cooling flow temp.	Compensation curve	
	Compensation curve	Hi flow temp. set point	Zone1 outdoor ambient temp.		-30°C - +33°C *3	-15°C	
			Zone1 flow temp.		25°C - 60°C	50°C	
			Zone2 outdoor ambient temp. *1		-30°C - +33°C *3	-15°C	
			Zone2 flow temp. *1		25°C - 60°C	40°C	
		Lo flow temp. set point	Zone1 outdoor ambient temp.		-28°C - +35°C *4	35°C	
			Zone1 flow temp.		25°C - 60°C	25°C	
			Zone2 outdoor ambient temp. *1		-28°C - +35°C *4	35°C	
			Zone2 flow temp.		25°C - 60°C	25°C	
		Adjust	Zone1 outdoor ambient temp.		-29°C - +34°C *5	—	
			Zone1 flow temp.		25°C - 60°C	—	
			Zone2 outdoor ambient temp. *1		-29°C - +34°C *5	—	
			Zone2 flow temp. *1		25°C - 60°C	—	
	Holiday	DHW *14		Active/Non active	Non active		
		Heating/ Cooling *13		Active/Non active	Active		
Zone1 heating room temp.		10°C - 30°C	15°C				
Zone2 heating room temp. *15		10°C - 30°C	15°C				
Zone1 heating flow temp.		25°C - 60°C	35°C				
Zone2 heating flow temp. *1		25°C - 60°C	25°C				
Zone1 cooling flow temp. *13		5°C - 25°C	25°C				
Zone2 cooling flow temp. *13		5°C - 25°C	25°C				
Initial settings	Language		EN/FR/DE/SV/ES/IT/DA/NL/FI/NO/PT/BG/PL/CZ/RU	EN			
	°C/°F		°C/°F	°C			
	Summer time		On/Off	Off			
	Temp. display		Room/DHW tank/Room&DHW tank /Off	Off			
	Time display		hh:mm/ hh:mm AM/AM hh:mm	hh:mm			
	Room sensor settings for Zone1		TH1/Main RC/Room RC1-8/"Time/Zone"	TH1			
	Room sensor settings for Zone2 *1		TH1/Main RC/Room RC1-8/"Time/Zone"	TH1			
Room RC zone select *1		Zone1/Zone2	Zone1				
Service menu	Thermistor adjustment	THW1		-10°C - +10°C	0°C		
		THW2		-10°C - +10°C	0°C		
		THW5		-10°C - +10°C	0°C		
		THW6		-10°C - +10°C	0°C		
		THW7		-10°C - +10°C	0°C		
		THW8		-10°C - +10°C	0°C		
		THW9		-10°C - +10°C	0°C		
		THWB1		-10°C - +10°C	0°C		
		THWB2		-10°C - +10°C	0°C		
	Auxiliary settings	Economy settings for pump.		On/Off *7	On		
		Delay (3 - 60 min)			10 min		
		Electric heater (Heating)		Space heating: On (used)/Off (not used)	On		
		Electric heater delay timer (5 - 180 min)			30 min		
		Electric heater (DHW) *14		Booster heater DHW: On (used)/Off (not used)	On		
		Immersion heater DHW: On (used)/Off (not used)			On		
		Electric heater delay timer (15 - 30 min)			15 min		
		Mixing valve control		Running (10 - 240 seconds)	120 seconds		
		Interval (1 - 30 min)			2 min		
Flow sensor *6	Minimum(0 - 100L/min)			5 L/min			
	Maximum(0 - 100L/min)			100 L/min			

*1 The settings related to Zone2 can be switched only when 2 Zone temperature control is enabled (when DIP SW2-6 and SW 2-7 are ON).
 *2 For the model without both booster and immersion heater, it may not reach the set temperature depending on the outside ambient temperature.
 *3 The lower limit is -15°C depending on the connected outdoor unit.
 *4 The lower limit is -13°C depending on the connected outdoor unit.
 *5 The lower limit is -14°C depending on the connected outdoor unit.
 *6 Do not change the setting since it is set according to the specification of flow sensor attached to the hydrobox.

Engineers Forms

Commissioning/Field settings record sheet (continued from the previous page)

EHSE/ERSE series

Main remote controller screen			Parameters	Default setting	Field setting	Notes		
Service menu	Pump speed		Pump speed(1 - 5)	5				
	Heat source setting		Standard/Heater/Boiler/Hybrid *8	Standard				
	Operation settings	Heating operation *9	Flow temp.range *11	Min.temp.(25 - 45°C)	30°C			
				Max.temp.(35 - 60°C)	50°C			
			Room temp.control *17	Mode(Normal/Fast)	Normal			
				Interval(10 - 60min)	10min			
			Heat pump thermo diff.adjust	On/Off *7	On			
		Lower limit(-9 - -1°C)		-5°C				
		Upper limit(+3 - +5°C)		5°C				
		Freeze stat function *12		Outdoor ambient temp. (3 - 20°C) / **	5°C			
		Simultaneous operation (DHW/Heating)		On/Off *7	Off			
				Outdoor ambient temp. (-30 - +10°C) *4	-15°C			
	Cold weather function		On/Off *7	Off				
			Outdoor ambient temp. (-30 - -10°C) *4	-15°C				
	Boiler operation		Hybrid settings	Outdoor ambient temp. (-30 - +10°C) *4	-15°C			
				Priority mode (Ambient/ Cost/CO ₂)	Ambient			
			Intelligent settings	Energy price *10	Electricity (0.001 - 999 */kWh)	0.5 */kWh		
					Boiler (0.001 - 999 */kWh)	0.5 */kWh		
			CO ₂ emission		Electricity (0.001 - 999 kg -CO ₂ /kWh)	0.5 kg -CO ₂ /kWh		
					Boiler (0.001 - 999 kg -CO ₂ / kWh)	0.5 kg -CO ₂ /kWh		
			Heat source		Heat pump capacity (1 - 40 kW)	11.2 kW		
					Boiler efficiency (25 - 150%)	80%		
					Booster heater 1 capacity (0 - 30 kW)	2 kW		
					Booster heater 2 capacity (0 - 30 kW)	4 kW		
	Floor dry up function		On/Off *7	Off				
			Target temp.	Start&Finish (25 - 60°C)	30°C			
				Max. temp. (25 - 60°C)	45°C			
				Max. temp. period (1 - 20 days)	5 days			
			Flow temp. (Increase)		Temp. increase step (+1 - +10°C)	+5°C		
					Increase interval (1 - 7 days)	2 days		
Flow temp. (Decrease)		Temp. decrease step (-1 - -10°C)	-5°C					
		Decrease interval (1 - 7 days)	2 days					
Energy monitor settings		Electric heater capacity	Booster heater 1 capacity	0 - 30kW	3kW			
			Booster heater 2 capacity	0 - 30kW	6kW			
			Immersion heater capacity	0 - 30kW	0kW			
		Delivered energy adjustment		-50 - +50%	0%			
Water pump input		Pump 1	0 - 200W	*** *16				
		Pump 2	0 - 200W	0W				
		Pump 3	0 - 200W	0W				
Electric energy meter		0.1/1/10/100/1000 pulse/kWh	1 pulse/kWh					
Heat meter		0.1/1/10/100/1000 pulse/kWh	1 pulse/kWh					
External input settings		Demand control (IN4)	Heat source OFF/Boiler operation	Boiler operation				
		Outdoor thermostat (IN5)	Heater operation/Boiler operation	Boiler operation				

*7 On: the function is active; Off: the function is inactive.

*8 When DIP SW1-1 is set to OFF "WITHOUT Boiler" or SW2-6 is set to OFF "WITHOUT Mixing tank", neither Boiler nor Hybrid can be selected.

*9 Valid only when operating in Room temp. control mode.

10 "" of */kWh" represents currency unit (e.g. € or £ or the like)

*11 Valid only when operating in Heating room temperature.

*12 If asterisk (**) is chosen freeze stat function is deactivated. (i.e. primary water freeze risk)

*13 Cooling mode settings are available for ERS * model only.

*14 Only available if DHW tank present in system.

*15 The settings related to Zone2 can be switched only when 2-zone temperature control or 2-zone valve ON/OFF control is active.

*16 Please change setting according to <Table 3.7>.

*17 When DIP SW5-2 is set to OFF, the function is active.

■ Refrigerant collecting (pumpdown) for split model systems only

Refer to "Refrigerant collection" in the outdoor unit installation manual or service manual.

■ Back-up operation of boiler

Heating operation is backed up by boiler.

For more details, refer to the installation manual of PAC-TH011HT-E.

<Installation & System set up>

1. Set DIP-SW 1-1 to ON "With boiler" and SW2-6 to ON "With Mixing tank".
2. Install the thermistors THWB1 (Flow temp.) and THWB2 (Return temp.) *1 on the boiler circuit.
3. Connect the output wire (OUT10: Boiler operation) to the signal input (room thermostat input) on the boiler. *2
4. Install one of the following room temp. thermostats. *3

- Wireless remote controller (option)
- Room temp. thermostat (local supply)
- Main remote controller (remote position)

*1 The boiler temperature thermistor is an optional part.

*2 OUT10 has no voltage across it.

*3 Boiler heating is controlled on/off by the room temp. thermostat.

<Remote controller settings>

1. Go to Service menu > Heat source setting and choose "Boiler" or "Hybrid". *4
2. Go to Service menu > Operation settings > Boiler settings to make detailed settings for "Hybrid" above .

*4 The "Hybrid" automatically switches heat sources between Heat pump (and Electric heater) and boiler.

■ Multiple outdoor units control (Hydrobox)

To realize bigger systems by using multiple outdoor units, up to 6 units of the same model can be connected.

The hydrobox can be used as a slave unit for multiple outdoor unit control.

For more details, refer to the installation manual of PAC-IF061/062B-E.

PAC-IF051/052B-E can not be connected to the hydrobox.

Check the model name of connecting master unit.

<DIP switch setting>

- Set DIP SW4-1 to ON "Active: multiple outdoor unit control".
- Keep DIP SW4-2 OFF (default setting) (master/slave setting: slave).
- Set DIP SW1-3 to ON when the hydrobox is connected to a DHW tank.

Note : PUHZ-FRP outdoor unit is not available for multiple outdoor units control.(except for EHSE/ERSE series)

■ Product fiche of temperature control

(a) Supplier's name: MITSUBISHI ELECTRIC CORPORATION

(b) Supplier's model identifier: PAR-WT50R-E and PAR-WR51R-E

(c) The class of the temperature control: VI

(d) The contribution of the temperature control to seasonal space heating energy efficiency: 4%

1	Safety precautions	FOR INSTALLER	C-2
1.1	Before installation (Environment)		C-2
1.2	Before installation or relocation		C-2
1.3	Before electric work		C-2
1.4	Before starting the test run		C-2
1.5	Electric booster and immersion heaters		C-3
2	Installing the FTC unit		C-4
2.1	Check the parts (Fig. 2.1.1)		C-4
2.2	Choosing the FTC unit installation location		C-4
2.3	Installing the FTC unit (Fig. 2.3.1, 2.3.2, 2.3.3, 2.3.4)		C-5
3	System		C-6
3.1	First step (Electrical work)		C-6
3.2	Second step (Outdoor unit type)		C-6
3.3	Third step (Functions setting)		C-7
3.4	Fourth step (Functions setting)		C-8
3.5	Local system		C-11
3.6	Piping diagram for 2-zone temperature control		C-11
3.7	Energy monitor		C-12
4	Electrical work		C-13
4.1	Electrical connection		C-13
4.2	Connecting the main remote controller		C-15
4.3	Main Remote Controller Options		C-18
4.4	Connecting the thermistor cables		C-20
4.5	Connecting inputs/outputs		C-22
4.6	Wiring for heater		C-24
4.7	Wiring for 2-zone temperature control		C-25
4.8	2-zone valve ON/OFF control		C-25
4.9	Smart grid ready		C-25
4.10	Installation procedure for DHW tank		C-26
4.11	Using SD memory card		C-27
5	DIP Switch setting		C-28
5.1	DIP Switch Functions		C-28
5.2	Outdoor unit type		C-29
5.3	Functions setting		C-29
5.4	Operation setting		C-31
5.5	Emergency mode (Heater only operation)		C-32
5.6	Emergency mode (Boiler operation)		C-32
5.7	Indoor unit only operation (during installation work)		C-32
6	Before test run		C-33
6.1	Check		C-33
6.2	Self-check		C-33
7	Main remote controller operation		C-34
7.1	Safety precautions	FOR USER	C-34
7.2	Main remote controller		C-35
8	Troubleshooting		C-50
9	Multiple outdoor units control		C-55
9.1	Wiring for multiple outdoor units control		C-55
9.2	Pipe work		C-55
9.3	Electrical connection		C-59
9.4	Main remote controller wiring		C-61
9.5	Connecting the thermistor cables		C-61
9.6	Dip switch functions		C-62
9.7	Connecting inputs/outputs		C-63
10	Supplementary information		C-67
10.1	Refrigerant collecting (pumpdown) for split model systems only		C-67
10.2	Back-up operation of boiler		C-67
10.3	Product fiche of temperature control		C-67

- ▶ Before installing the FTC unit, make sure you read all the "Safety precautions".
- ▶ Please report to your supply authority or obtain their consent before connecting this equipment to the power supply system.

⚠ Warning:

Precautions that must be observed to prevent injuries or death.

⚠ Caution:

Precautions that must be observed to prevent damage to the unit.

After installation, perform the test run to ensure normal operation. Then explain to your customer the "Safety Precautions" *1, use, and maintenance of the unit based on the information in this manual. This manual must be given to the user. This manual must always be kept by the actual users.

*1 "Safety Precautions" for user is indicated on page C-34.

⚡ : This indicates a part which must be grounded.

⚠ Warning:

Carefully read the labels attached to the unit.

⚠ Warning:

- The unit must not be installed by the user. Ask an installer or an authorized technician to install the unit. If the unit is installed improperly, electric shock, or fire may be caused.
- For installation work, follow the instructions in the Installation Manual and use tools and pipe components specifically made for use with refrigerant specified in the outdoor unit installation manual.
- The unit must be installed according to the instructions in order to minimize the risk of damage by earthquakes, typhoons, or strong winds. Improperly installed units may fall down and cause damage or injuries.
- The unit must be securely installed on a structure that can sustain its weight. If the unit is mounted on an unstable structure, it may fall down and cause damage or injuries.
- All electric work must be performed by a qualified technician according to local regulations and the instructions given in this manual. The unit must be powered by dedicated power lines and the correct voltage and circuit breakers must be used. Power lines with insufficient capacity or incorrect electrical work may result in electric shock or fire.

- Only the specified cables can be used for wiring. Connections must be made securely without tension on the terminals. If cables are connected or installed improperly, it may result in overheating or fire.
- Terminal block cover panel of the unit must be firmly fixed. If the cover panel is mounted improperly, dust and moisture may enter the unit, and it may cause electric shock or fire.
- Make sure to use accessories authorized by Mitsubishi Electric and ask an installer or an authorized technician to install them. If accessories are improperly installed, it may cause electric shock, or fire.
- Do not remodel the unit. Consult an installer for repairs. If alterations or repairs are not performed correctly, it may cause electric shock or fire.
- The user should never attempt to repair the unit or transfer it to another location. If the unit is installed improperly, it may cause electric shock or fire. If the FTC unit needs to be repaired or moved, ask an installer or an authorized technician.
- During installing a heat pump system, keep water from splashing on the FTC unit.
- When installing sensors and parts, do not expose the terminals.

1.1 Before installation (Environment)

⚠ Caution:

- Do not install the FTC unit in outdoor location as it is designed for indoor installation only. Otherwise electric shock or breakdown may be caused by water, wind or dust.
- Do not use the unit in an unusual environment. If the FTC unit is installed or exposed to steam, volatile oil (including machine oil), or sulfuric gas, or exposed to briny air, the internal parts can be damaged.
- Do not install the unit where combustible gases may leak, be produced, flow, or accumulate. If combustible gas accumulates around the unit, it may cause fire or explosion.

- When installing the unit in a hospital or in a building where communications equipment are installed, you may need to take measures to prevent noise and electronic interference. Inverters, home appliances, high-frequency medical equipment, and radio communications equipment can cause the FTC unit to malfunction or to breakdown. At the same time, the noise and electric interference from the FTC unit may disturb the proper operation of nearby medical equipment, and communications equipment.

1.2 Before installation or relocation

⚠ Caution:

- Be very careful when moving the units. Do not hold the packaging bands. Wear protective gloves to unpack and to move the units, in order to avoid injury to your hands.

- Be sure to safely dispose of the packaging materials. Packaging materials, such as nails and other metal or wooden parts may cause injuries.
- Do not wash the FTC unit. You may receive an electric shock.

1.3 Before electric work

⚠ Caution:

- Be sure to install a circuit breaker. If it is not installed, there may be a risk to get an electric shock.
- For the power lines, use standard cables of sufficient capacity. Otherwise, it may cause a short circuit, overheating, or fire.
- When installing the power lines, do not apply tension to the cables. The cables may be cut or overheated resulting in a fire.

- Make sure to ground the unit. Do not connect the ground wire to gas or water pipes, lightning rods, or telephone grounding lines. If the unit is not properly grounded, there may be a risk to get an electric shock.
- Make sure to use circuit breakers (ground fault interrupter, isolating switch (+B fuse), and molded case circuit breaker) with the specified capacity. If the circuit breaker capacity is larger than the specified capacity, breakdown or fire may result.

1.4 Before starting the test run

⚠ Caution:

- Turn on the main power switch of the outdoor unit more than 12 hours before starting operation. Starting operation immediately after turning on the power switch can severely damage the internal parts. Keep the main power switch turned on during the operation period.
- In heating mode, to avoid the heat emitters being damaged by excessively hot water, set the target flow temperature to a minimum of 2°C below the maximum allowable temperature of all the heat emitters. For Zone2, set the target flow temperature to a minimum of 5°C below the maximum allowable flow temperature of all the heat emitters in Zone2 circuit.

- Before starting operation, check that all protective parts are correctly installed. Make sure not to get injured by touching high voltage parts.
- Do not touch any switch with wet hands. There may be a risk to get an electric shock.
- After stopping operation, make sure to wait at least 5 minutes before turning off the main power. Otherwise, it may cause breakdown.

1.5 Electric booster and immersion heaters

⚠ Warning:

- FTC has signal outputs for heaters however it can not isolate power to them in the event of overheating. All electrical heaters used on the water circuit must have.
 - a) A thermostat to prevent overheating.
 - b) A non-self resetting thermal mechanism to prevent overheating.

Abbreviations and glossary

Abbreviations/Word	Description
Ambient temperature	The outdoor temperature
Freeze stat. function	Heating to prevent water pipes freezing
ASHP/HP	Air source heat pump
COP	Coefficient of performance the efficiency of the heat pump
Cylinder unit	Indoor unvented DHW tank and component plumbing parts
Hydrobox	Indoor unit housing the component plumbing parts (NO DHW tank)
DeltaT	Difference in temperature between two system locations
DHW mode	Domestic hot water heating mode for showers, sinks, etc
Flow temperature	Temperature at which water is delivered to the primary circuit
FTC (Master)	Flow temperature controller, the circuit board in charge of controlling the system, master board for multiple outdoor units control
FTC (Slave)	Slave board for multiple outdoor units control
Compensation curve mode	Space heating incorporating outdoor temperature compensation
Heating mode	Space heating through radiators or under floor heating
Cooling mode	Space cooling through radiators or under floor cooling
Legionella	Bacteria potentially found in plumbing, showers and water tanks that may cause Legionnaires disease
LP mode	Legionella prevention mode – a function on systems with tanks to prevent the growth of legionella bacterium
Packaged model	Plate heat exchanger (Refrigerant - Water) in the outdoor heat pump unit
Split model	Plate heat exchanger (Refrigerant - Water) in the indoor unit
TRV	Thermostatic radiator valve – a valve on the entrance or exit of the radiator panel controlling the heat output

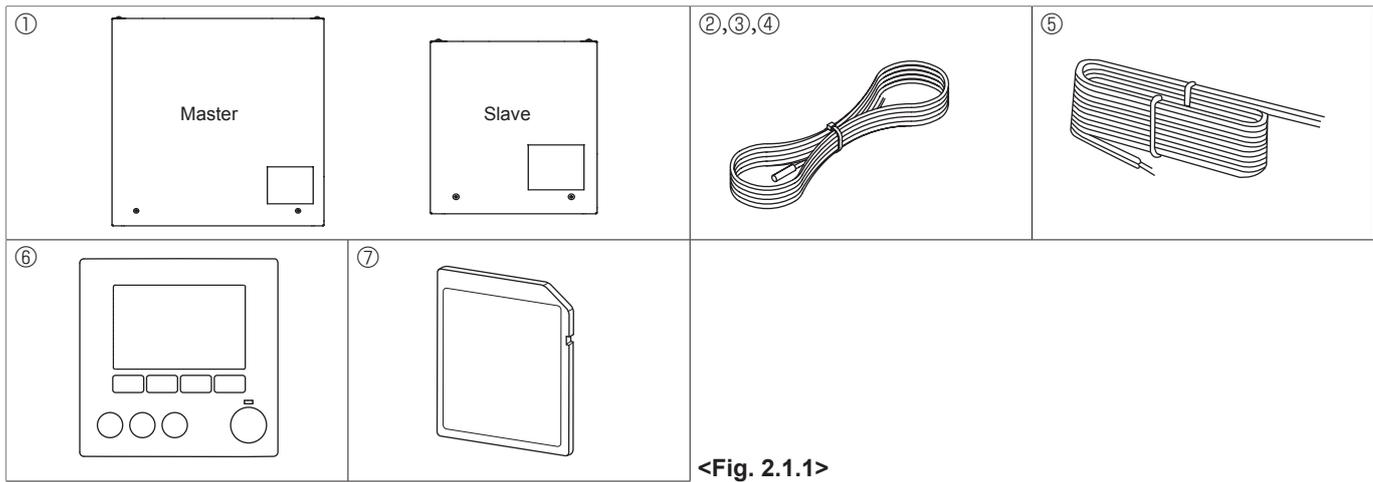

2.1 Check the parts (Fig. 2.1.1)

The FTC unit should be supplied with the following parts.

Part name	Wiring diagram symbol	Q'ty			
		PAC-IF061	PAC-IF062	PAC-IF063	PAC-SIF051
① FTC (master) unit/FTC (slave) unit		1	1	1	1
② Liquid refrigerant temp. thermistor (Lead wire: 5m/Red, Connector: 3p/Yellow)	TH2	1	—	—	1
③ Flow water temp. and Return water temp. thermistor (Lead wire: Gray (Flow water temp.), Black(Return water temp.), Connector: 4p/Red)	THW1/2	1 (5m/5m)	1 (5m/5m)	1 (1.1m/ 1.2m)	1 (5m/5m)
④ Tank temp. thermistor (Lead wire: 1.8m/Gray, connector: 2p/white)	THW5	—	—	1	—
⑤ Main remote controller cable (10 m)		1	1	1	1
⑥ Main remote controller		1	1	1	—
⑦ SD memory card		1	1	1	1

2.2 Choosing the FTC unit installation location

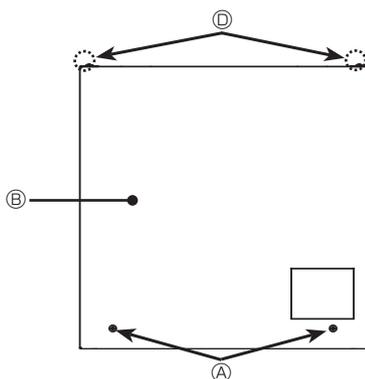

- Do not install the FTC units outdoors as it is designed for indoor installation only. (The FTC circuit board and casing are not waterproof.)
- Avoid locations where the unit is exposed to direct sunlight or other sources of heat.
- Select a location where easy wiring access to the power source is available.
- Avoid locations where combustible gases may leak, be produced, flow, or accumulate.
- Select a level location that can bear the weight and vibration of the unit.
- Avoid locations where the unit is exposed to oil, steam, or sulfuric gas.
- Do not install in location that is hot or humid for long periods of time.

The FTC (Master) is designed for use with a number of heat pump systems. Please refer to the following table to find the relevant installation information for your system.

For multiple outdoor units control with FTC (Slave), see section 9.

3.1 First step (Electrical work)

Power supplies	System diagram	Reference section
FTC (Master) powered via outdoor unit		4.1 4.2
FTC (Master) powered by independent source		4.1 4.2

3.2 Second step (Outdoor unit type)

Outdoor unit type	System diagram	Thermistor	Reference section
Split		TH2: Liquid refrigerant temp.	4.4 5.2
Packaged		—	4.4 5.2

* PAC-IF062/063B-E is not available for Split-type system.

3.3 Third step (Functions setting)

DHW tank	Immersion heater	Booster heater	BH function	System diagram	Thermistor	Reference section	Remarks
Present	Absent	Present	For heating and DHW		THW1: Flow water temp. THW2: Return water temp. THW5: Tank water temp.	4.4 4.5 5.3	
Present	Present	Present	For heating and DHW		THW1: Flow water temp. THW2: Return water temp. THW5: Tank water temp.	4.4 4.5 5.3	
Present	Absent	Present	For heating only		THW1: Flow water temp. THW2: Return water temp. THW5: Tank water temp.	4.4 4.5 5.3	1. 'Legionella Prevention Mode' cannot be selected in this system.
Present	Absent	Absent	—		THW1: Flow water temp. THW2: Return water temp. THW5: Tank water temp.	4.4 4.5 5.3	1. 'Legionella Prevention Mode' cannot be selected in this system. 2. Please make sure water circuit not to get frozen during defrost.
Present	Present	Present	For heating only		THW1: Flow water temp. THW2: Return water temp. THW5: Tank water temp.	4.4 4.5 5.3	
Present	Present	Absent	—		THW1: Flow water temp. THW2: Return water temp. THW5: Tank water temp.	4.4 4.5 5.3	
Absent	Absent	Present	—		THW1: Flow water temp. THW2: Return water temp.	4.4 4.5 5.3	
Absent	Absent	Absent	—		THW1: Flow water temp. THW2: Return water temp.	4.4 4.5 5.3	1. Please make sure water circuit not to get frozen during defrost.

* The use of two 2-way valves can perform same function as a 3-way valve.

3.4 Fourth step (Functions setting)

* Make sure to check the followings for your safety when designing a system. These are the minimum requirement for the safe use of FTC unit.

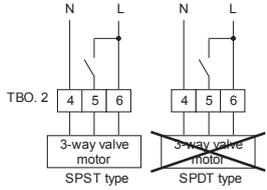
Parts name	Requirement																																									
Flow switch	It is required to protect system from the effects of insufficient flow.																																									
Flow sensor	It is required to detect an error in flow rate. (The operation is validated with GRUNDFOS VFS5-100.) It is required for Energy monitor function.																																									
Strainer /Magnetic filter (water circuit)	Provide it as required to protect parts from damages caused by iron particles/water/contamination (e.g. the position before pump and return part from emitters).																																									
Pressure relief valve (Primary circuit side) (Sanitary water side)	It is required to protect system from reaching high pressure. Select the operating pressure depending on water pressure in the circuit in normal use. ※Follow the national regulations.																																									
3-way valve	<p>Current: 0.1A Max. (If over 0.1A you must use a relay) Power supply: 230V AC Connect earth cable, if there is one. Type: SPST ※SPDT type can NOT be used.</p> 																																									
2-way valve	<p>Current: 0.1A Max. (If over 0.1A you must use a relay) Power supply: 230V AC Connect earth cable, if there is one. Type: Normally closed Select the 2-way valve that slowly opens and shuts off to prevent water hammer. A by-pass valve or circuit should be installed between pump and 2-way valve for safety (to release pressure when the both 2-way valves are closed). Select a 2-way valve equipped with manual override, which is necessary for topping up or draining of water.</p>																																									
Water circulation pump	<p>Current: 1.0A Max., Power supply: 230V AC When connecting a pump with an electric current of $\geq 1A$ or multiple pumps, please note the following.</p> <ol style="list-style-type: none"> Use (a) relay(s). When power is supplied from outdoor unit, TOTAL current (including the other parts) requirement MUST be $\leq 3A$. (otherwise, the fuse on the outdoor unit PCB will blow.) When independent power supplies (i.e. from the FTC unit itself) , total current for the pump(s) is $\leq 4A$. (otherwise, the fuse on the FTC PCB will blow.) <p>Connect earth cable, if there is one. Adjust the pump speed setting so that the flow rate in the primary circuit is appropriate for the outdoor unit installed see the table and figures below.</p> <table border="1" data-bbox="300 1361 901 1863"> <thead> <tr> <th colspan="2">Outdoor heat pump unit</th> <th>Water flow rate range [L/min]</th> </tr> </thead> <tbody> <tr> <td rowspan="5">Packaged model</td> <td>PUHZ-W50</td> <td>6.5 - 14.3</td> </tr> <tr> <td>PUHZ-W85</td> <td>10.8 - 25.8</td> </tr> <tr> <td>PUHZ-W112</td> <td>14.4 - 32.1</td> </tr> <tr> <td>PUHZ-HW112</td> <td>14.4 - 32.1</td> </tr> <tr> <td>PUHZ-HW140</td> <td>17.9 - 40.1</td> </tr> <tr> <td rowspan="13">Split model</td> <td>SUHZ-SW45</td> <td>7.1 - 12.9</td> </tr> <tr> <td>PUHZ-SW40</td> <td>7.1 - 11.8</td> </tr> <tr> <td>PUHZ-SW50</td> <td>7.1 - 17.2</td> </tr> <tr> <td>PUHZ-FRP71</td> <td>11.5 - 22.9</td> </tr> <tr> <td>PUHZ-SW75</td> <td>9.5 - 22.9</td> </tr> <tr> <td>PUHZ-SW100</td> <td>13.0 - 32.1</td> </tr> <tr> <td>PUHZ-SW120</td> <td>17.9 - 45.9</td> </tr> <tr> <td>PUHZ-SW160</td> <td>23.0 - 63.1</td> </tr> <tr> <td>PUHZ-SW200</td> <td>28.7 - 71.7</td> </tr> <tr> <td>PUHZ-SHW80</td> <td>10.2 - 22.9</td> </tr> <tr> <td>PUHZ-SHW112</td> <td>14.4 - 32.1</td> </tr> <tr> <td>PUHZ-SHW140</td> <td>17.9 - 40.1</td> </tr> <tr> <td>PUHZ-SHW230</td> <td>28.7 - 65.9</td> </tr> </tbody> </table> <p>* The water velocity in pipes should be kept within certain limits of material to avoid erosion corrosion and excessive noise generation. (e.g. Copper pipe: 1.5m/s)</p>	Outdoor heat pump unit		Water flow rate range [L/min]	Packaged model	PUHZ-W50	6.5 - 14.3	PUHZ-W85	10.8 - 25.8	PUHZ-W112	14.4 - 32.1	PUHZ-HW112	14.4 - 32.1	PUHZ-HW140	17.9 - 40.1	Split model	SUHZ-SW45	7.1 - 12.9	PUHZ-SW40	7.1 - 11.8	PUHZ-SW50	7.1 - 17.2	PUHZ-FRP71	11.5 - 22.9	PUHZ-SW75	9.5 - 22.9	PUHZ-SW100	13.0 - 32.1	PUHZ-SW120	17.9 - 45.9	PUHZ-SW160	23.0 - 63.1	PUHZ-SW200	28.7 - 71.7	PUHZ-SHW80	10.2 - 22.9	PUHZ-SHW112	14.4 - 32.1	PUHZ-SHW140	17.9 - 40.1	PUHZ-SHW230	28.7 - 65.9
Outdoor heat pump unit		Water flow rate range [L/min]																																								
Packaged model	PUHZ-W50	6.5 - 14.3																																								
	PUHZ-W85	10.8 - 25.8																																								
	PUHZ-W112	14.4 - 32.1																																								
	PUHZ-HW112	14.4 - 32.1																																								
	PUHZ-HW140	17.9 - 40.1																																								
Split model	SUHZ-SW45	7.1 - 12.9																																								
	PUHZ-SW40	7.1 - 11.8																																								
	PUHZ-SW50	7.1 - 17.2																																								
	PUHZ-FRP71	11.5 - 22.9																																								
	PUHZ-SW75	9.5 - 22.9																																								
	PUHZ-SW100	13.0 - 32.1																																								
	PUHZ-SW120	17.9 - 45.9																																								
	PUHZ-SW160	23.0 - 63.1																																								
	PUHZ-SW200	28.7 - 71.7																																								
	PUHZ-SHW80	10.2 - 22.9																																								
	PUHZ-SHW112	14.4 - 32.1																																								
	PUHZ-SHW140	17.9 - 40.1																																								
	PUHZ-SHW230	28.7 - 65.9																																								

Continue to the next page.

From the previous page.

Parts name	Requirement
Water circulation pump	<p>(1) Packaged-type units</p> <p>■ Heating</p> <div style="display: flex; justify-content: space-around;"> <div data-bbox="343 331 901 609"> <p>PUHZ-W50</p> </div> <div data-bbox="949 331 1508 609"> <p>PUHZ-W85</p> </div> </div> <div style="display: flex; justify-content: space-around; margin-top: 20px;"> <div data-bbox="343 627 901 929"> <p>PUHZ-W112 PUHZ-HW112/140</p> </div> </div> <p>(2) Split-type units</p> <p>■ Heating</p> <div style="display: flex; justify-content: space-around;"> <div data-bbox="343 1008 901 1310"> <p>PUHZ-SW40/50 *1 SUHZ-SW45 *1</p> </div> <div data-bbox="949 1008 1508 1310"> <p>PUHZ-SW75 *2 PUHZ-SHW80 *2</p> </div> </div> <div style="display: flex; justify-content: space-around; margin-top: 20px;"> <div data-bbox="343 1332 901 1635"> <p>PUHZ-SW100/120 *3 PUHZ-SHW112/140 *3</p> </div> <div data-bbox="949 1332 1508 1635"> <p>PUHZ-SHW230 *4</p> </div> </div> <div data-bbox="343 1657 901 1937"> <p>PUHZ-SW160 *4 PUHZ-SW200 *4</p> </div> <p>*1 When the connected plate heat exchanger is ACH 30-30 made by ALFA LAVAL. *2 When the connected plate heat exchanger is ACH 70-30 made by ALFA LAVAL. *3 When the connected plate heat exchanger is ACH 70-40 made by ALFA LAVAL. *4 When two ACH 70-40 plate heat exchangers made by ALFA LAVAL are parallel-connected.</p>

Flow temp.controller

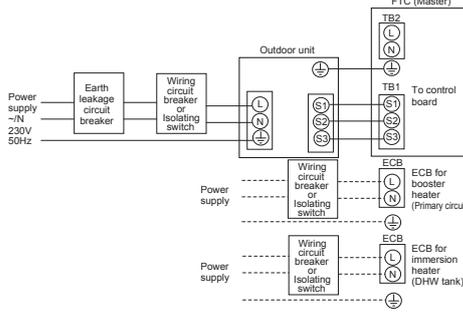
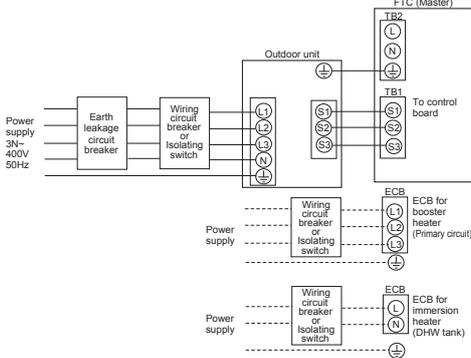
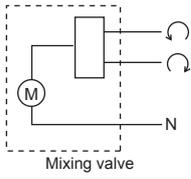
Parts name	Requirement																						
Booster heater	General <ul style="list-style-type: none"> * Consider necessity and capacity of booster heater to meet the following points. <ol style="list-style-type: none"> (1) Heating capacity and flow water temperature should always be sufficient. (2) System can increase the temperature of the stored water in tank to inhibit legionella bacterium growth. <ul style="list-style-type: none"> (Note) System without neither booster heater or immersion heater, 'Legionella Prevention Mode' is NOT available. (3) Water circuit should not be frozen during defrost operation. 																						
	Control Power for Contactor <ul style="list-style-type: none"> Current: 0.5A Max. , Power supply: 230V AC * Use a relay. 																						
	Separate power for Heater <ul style="list-style-type: none"> Install an earth leakage circuit breaker (ECB) for heater, separate from control power (See Fig.1 and Fig.2). * When using two booster heaters, booster heater 1 capacity must be less than that of booster heater 2. When using a single booster heater, connect to BH1 (TBO.5 5-6 (OUT6)) , and turn the Dip SW2-3 to ON. (Booster heater capacity restriction) <div style="display: flex; justify-content: space-around;"> <div style="text-align: center;">  <p><Fig. 1 (1 phase)></p> </div> <div style="text-align: center;">  <p><Fig. 2 (3 phase)></p> </div> </div> <div style="display: flex; justify-content: space-around;"> <div style="text-align: center;"> <p>Heater capacity/Breaker/wiring (recommended)</p> <p><1 Phase></p> <table border="1"> <thead> <tr> <th>Description</th> <th>Power supply</th> <th>Total capacity (BH1 + BH2)</th> <th>Breaker</th> <th>Wiring</th> </tr> </thead> <tbody> <tr> <td rowspan="2">Booster heater (Primary circuit)</td> <td rowspan="2">~ /N 230V 50Hz</td> <td>2 kW (2 kW + 0 kW)</td> <td>16 A</td> <td>2.5 mm²</td> </tr> <tr> <td>6 kW (2 kW + 4 kW)</td> <td>32 A</td> <td>6.0 mm²</td> </tr> </tbody> </table> </div> <div style="text-align: center;"> <p><3 Phase></p> <table border="1"> <thead> <tr> <th>Description</th> <th>Power supply</th> <th>Total capacity (BH1 + BH2)</th> <th>Breaker</th> <th>Wiring</th> </tr> </thead> <tbody> <tr> <td>Booster heater (Primary circuit)</td> <td>3~ 400V 50Hz</td> <td>9 kW (3 kW + 6 kW)</td> <td>16 A</td> <td>2.5 mm²</td> </tr> </tbody> </table> </div> </div> <ul style="list-style-type: none"> * When installing a booster heater with the capacity of bigger than shown above, select an appropriate size breaker and cable (diameter) based on the maximum possible electric current. 	Description	Power supply	Total capacity (BH1 + BH2)	Breaker	Wiring	Booster heater (Primary circuit)	~ /N 230V 50Hz	2 kW (2 kW + 0 kW)	16 A	2.5 mm ²	6 kW (2 kW + 4 kW)	32 A	6.0 mm ²	Description	Power supply	Total capacity (BH1 + BH2)	Breaker	Wiring	Booster heater (Primary circuit)	3~ 400V 50Hz	9 kW (3 kW + 6 kW)	16 A
Description	Power supply	Total capacity (BH1 + BH2)	Breaker	Wiring																			
Booster heater (Primary circuit)	~ /N 230V 50Hz	2 kW (2 kW + 0 kW)	16 A	2.5 mm ²																			
		6 kW (2 kW + 4 kW)	32 A	6.0 mm ²																			
Description	Power supply	Total capacity (BH1 + BH2)	Breaker	Wiring																			
Booster heater (Primary circuit)	3~ 400V 50Hz	9 kW (3 kW + 6 kW)	16 A	2.5 mm ²																			
Safety device	<ol style="list-style-type: none"> (1) Use an overheat protection thermostat (manual reset type) (to detect unusual temperature increase/heating up without water). Protection device operating temperature must be above 80°C. Protection device should not operate quickly, but water circuit must not boil even when heater(s) overshoot. <ul style="list-style-type: none"> (Reference value) Thermostat operation temperature used in our Cylinder unit and Hydrobox : 90°C ± 4°C (2) Connect a pressure relief valve on the primary circuit side. 																						
Immersion heater	General <ul style="list-style-type: none"> * Consider necessity and capacity of immersion heater to meet the following points. <ol style="list-style-type: none"> (1) Heating capacity and flow water temperature should always be sufficient. (2) System can increase the temperature of the stored water in tank to inhibit legionella bacterium growth. <ul style="list-style-type: none"> (Note) System without neither booster heater or immersion heater can not select 'Legionella Prevention Mode'. 																						
	Control Power for Contactor <ul style="list-style-type: none"> Current: 0.5A Max. , Power supply: 230V AC * Use a relay. 																						
	Separate power for heater <ul style="list-style-type: none"> Install an earth leakage circuit breaker (ECB) for heater, separate from control power (See Fig.1 and Fig.2). * ECB is built-in in PAC-IF062/063B-E. Heater capacity/Breaker/wiring (recommended) <p><1 Phase></p> <table border="1"> <thead> <tr> <th>Description</th> <th>Power supply</th> <th>Capacity</th> <th>Breaker</th> <th>Wiring</th> </tr> </thead> <tbody> <tr> <td>Immersion heater (DHW tank)</td> <td>~ /N 230V 50Hz</td> <td>3 kW</td> <td>16 A</td> <td>2.5 mm²</td> </tr> </tbody> </table> <ul style="list-style-type: none"> * When installing an immersion heater with the capacity of bigger than shown above, select an appropriate size breaker and cable (diameter) based on the maximum possible electric current. 	Description	Power supply	Capacity	Breaker	Wiring	Immersion heater (DHW tank)	~ /N 230V 50Hz	3 kW	16 A	2.5 mm ²												
Description	Power supply	Capacity	Breaker	Wiring																			
Immersion heater (DHW tank)	~ /N 230V 50Hz	3 kW	16 A	2.5 mm ²																			
Safety device	<ol style="list-style-type: none"> (1) Install the thermistor THW5 (optional parts PAC-TH011TK-E(5 m) or PAC-TH011TKL-E(30 m)) on the DHW tank. Note that PAC-IF063B-E comes with THW5. (Microcomputer detecting temperature for protection: 80°C) (2) Use a built-in direct cut-off thermostat (manual reset type). Protection device operating temperature must be above 80°C. Protection device should not operate quickly, but water circuit must not boil even when a heater overshoots. <ul style="list-style-type: none"> (Reference value) Thermostat operation temperature used in our Cylinder unit : 85°C ± 5°C (3) Connect a pressure relief valve on the sanitary water side. 																						
Mixing valve	<ul style="list-style-type: none"> Current: 0.1 A Max. (If over 0.1 A you must use a relay) Power supply: 230V AC Connect earth cable, if there is one. Type: Refer to the right figure. <div style="text-align: center;">  <p>Mixing valve</p> </div>																						
Expansion Vessel (Primary circuit side) Expansion Vessel (Sanitary water side)	<ul style="list-style-type: none"> When the water circuit is closed, select the expansion vessel according to water quantity of the water circuit. * Follow the national regulations. 																						
Limits of TOTAL electric current when connecting local supply parts	<ul style="list-style-type: none"> Option 1. (Power supply from outdoor unit) <ul style="list-style-type: none"> TOTAL current requirement MUST be ≤ 3A. (otherwise, the fuse on the outdoor unit PCB will blow.) Option 2. (Independent power supply (i.e. from the FTC unit itself)) <ul style="list-style-type: none"> TOTAL current of the pump(s) MUST be ≤ 4A. The total current allowed for parts except pumps is ≤ 3A. (otherwise, the fuse on the FTC PCB will blow.) 																						

3.5 Local system

1-zone temperature control

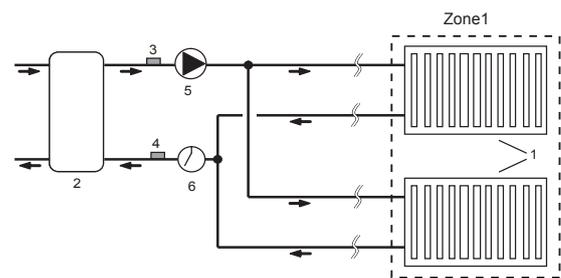
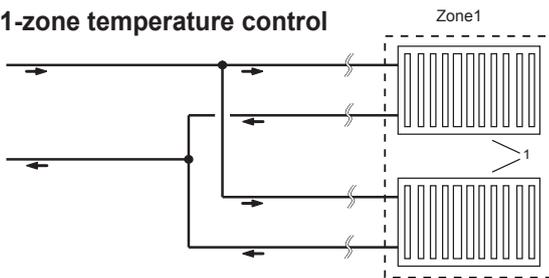

2-zone temperature control

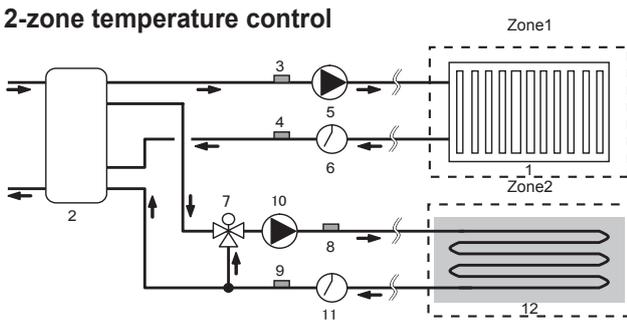

1-zone temperature control (2-zone valve ON/OFF control)

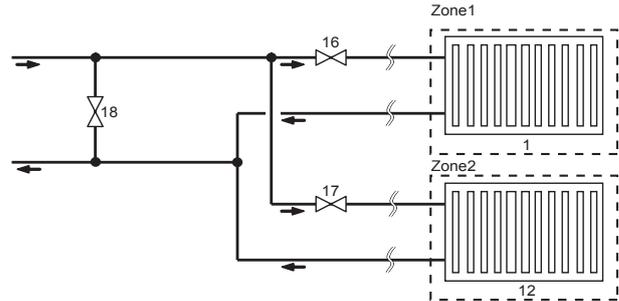

1-zone temperature control with boiler

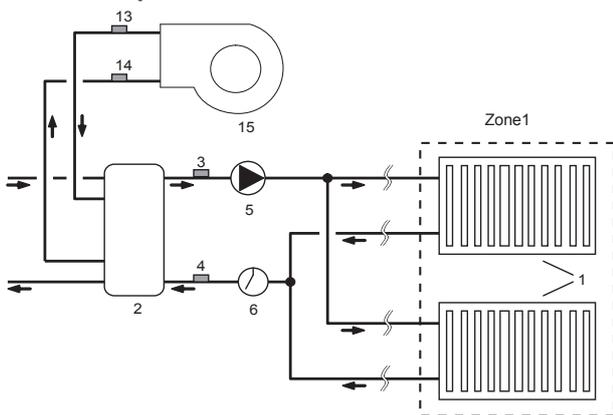

2-zone temperature control with boiler

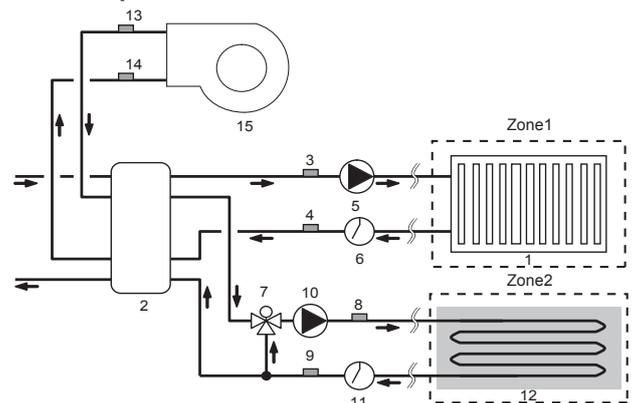

1. Zone1 heat emitters (e.g. radiator, fan coil unit) (local supply)
2. Mixing tank (local supply)
3. Zone1 flow water temp. thermistor (THW6) (option)
4. Zone1 return water temp. thermistor (THW7) (option)
5. Zone1 water circulation pump (local supply)
6. Zone1 flow switch (local supply)
7. Motorized mixing valve (local supply)
8. Zone2 flow water temp. thermistor (THW8) (option)
9. Zone2 return water temp. thermistor (THW9) (option)

10. Zone2 water circulation pump (local supply)
11. Zone2 flow switch (local supply)
12. Zone2 heat emitters (e.g. underfloor heating) (local supply)
13. Boiler flow water temp. thermistor (THWB1) (option)
14. Boiler return water temp. thermistor (THWB2) (option)
15. Boiler (local supply)
16. Zone1 2-way valve (local supply)
17. Zone2 2-way valve (local supply)
18. Bypass valve (local supply)

Note: Cooling mode cannot run under 2-zone temperature control but can run both in Zone1 and Zone2 under 1-zone temperature control.

3.6 Piping diagram for 2-zone temperature control

The following component parts are required for piping for 2-zone control operation.

Arrange the following component parts.

- Mixing tank (local supply)
- Motorized mixing valve (local supply)
- Water circulation pump (x 2) (local supply)
- Flow switch (x 2) (local supply)
- Thermistor (x 4) (2 sets of PAC-TH011-E) thermistors are required.

Wire the component parts to the water circuit referring to the figure below.

For more details on wiring, refer to "4.7 Wiring for 2-zone temperature controls".

Note: Do not install the thermistors on the mixing tank. This could affect correct monitoring of flow and return temperatures through each zone. Install the Zone2 flow temp. thermistor (THW8) near the mixing valve.

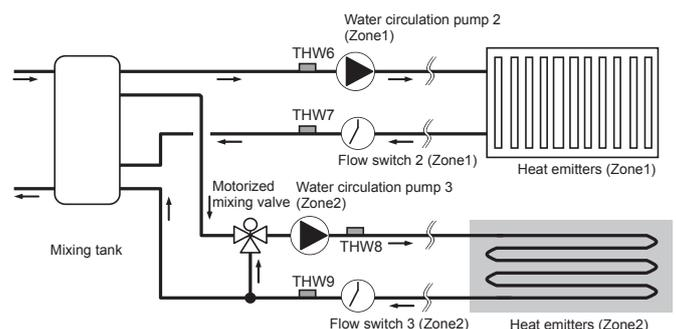

- Thermistor (THW6): Zone1 flow temp.
- Thermistor (THW7): Zone1 return temp.
- Thermistor (THW8): Zone2 flow temp.
- Thermistor (THW9): Zone2 return temp.

3.7 Energy monitor *3

End user can monitor accumulated*1 'Consumed electric energy' and 'Delivered heat energy' in each operation mode*2 on the main remote controller.

*1 Monthly and Year to date

*2 - DHW operation

- Space heating
- Space cooling

*3 Not available during Multiple outdoor unit control.

Refer to "7.2 Main remote controller" for how to check the energy, and "5.1 DIP switch functions" for the details on DIP-SW setting.

Either one of the following two method is used for monitoring.

Note: The method 1 should be used as a guide. If a certain accuracy is required, the method 2 should be used.

1. Calculation internally

Electricity consumption is calculated internally based on the energy consumption of outdoor unit, electric heater, water pump(s) and other auxiliaries.

Delivered heat is calculated internally by multiplying delta T (Flow and Return temp.) and flow rate measured by the locally supplied sensors.

Set the electric heater capacity and water pump(s) input according to indoor unit model and specs of additional pump(s) supplied locally. (Refer to the menu tree in "7.2 Main remote controller")

Booster heater1	Booster heater2	Immersion heater	Pump1	Pump2	Pump3
2kW*1	4kW*1	0kW*1	*** *1	0W*1	0W*1

<Table 3.7>

*1 Be sure to change the setting corresponding to the specification of locally supplied auxiliaries such as electric heater and pump.

When anti-freeze solution (propylene glycol) is used for primary water circuit, set the delivered energy adjustment if necessary. For further detail of above, refer to "7.2 Main remote controller".

2. Actual measurement by external meter (locally supplied)

FTC has external input terminals for 2 'Electric energy meters' and a 'Heat meter'.

If two 'Electric energy meters' are connected, the 2 recorded values will be combined at the FTC and shown on the main remote controller.

(e.g. Meter 1 for H/P power line, Meter 2 for heater power line)

Refer to the [Signal inputs] section in "4.5 Connecting inputs/outputs" for more information on connectable electric energy meter and heat meter.

4.1 Electrical connection

All electrical work should be carried out by a suitably qualified technician. Failure to comply with this could lead to electrocution, fire, and death. It will also invalidate product warranty. All wiring should be according to national wiring regulations.

For multiple outdoor units control with FTC (Slave), see section 9.

FTC (Master) can be powered in two ways.

1. Power cable is run from the outdoor unit to FTC (Master).
2. FTC (Master) has independent power source.

Connections should be made to the terminals indicated in the following figures depending on the phase.

Breaker abbreviation	Meaning
ECB	Earth leakage circuit breaker for immersion heater
TB1	Terminal bed 1
TB2	Terminal bed 2

Immersion heater should be connected independently from one another to dedicated power supplies.

- Notes:**
1. Do not run the low voltage cables through a slot that the high voltage cables go through.
 2. Do not run other cables except low voltage cables through a slot that the wireless receiver's cable goes through.
 3. Do not bundle power cables together with other cables.
 4. Bundle cables as figure above by using clamps.

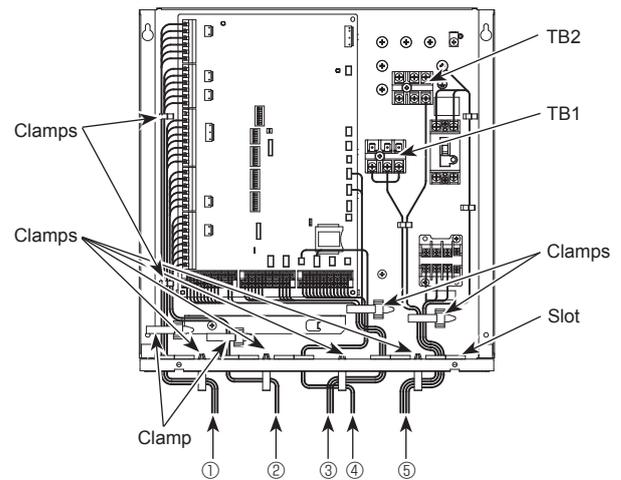

- ① High voltage cables (OUTPUT)
- ② High voltage cables (OUTPUT)
- ③ Low voltage cables (INPUT) and wireless receiver's cable
- ④ Thermistor cables
- ⑤ Power cables

<Fig. 4.1.1> Wiring for PAC-IF062/063B-E

Option 1: FTC (Master) powered via outdoor unit

<1 phase>

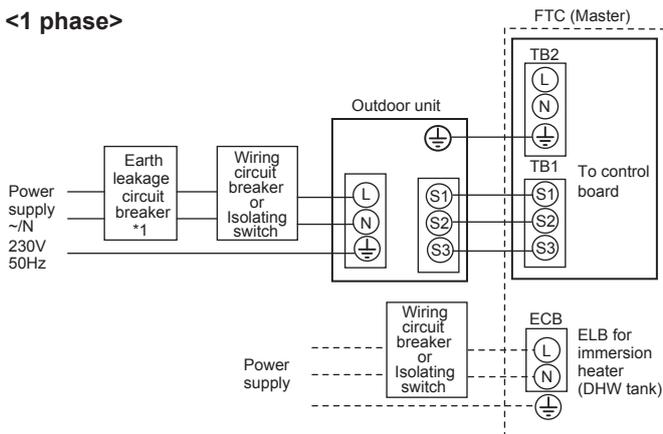

<3 phase>

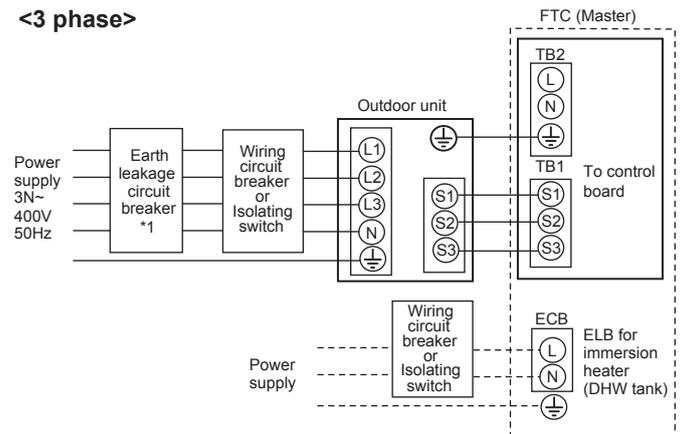

<Fig. 4.1.2>

Electrical connections 1 phase/3 phase

□ : PAC-IF061B-E

□ : PAC-IF062/063B-E

*1 If the installed earth leakage circuit breaker does not have an over-current protection function, install a breaker with that function along the same power line. A breaker with at least 3.0 mm contact separation in each pole shall be provided. Use earth leakage breaker (NV). The breaker shall be provided to ensure disconnection of all active phase conductors of the supply.

Note: In accordance with IEE regulations the circuit breaker/isolating switch located on the outdoor unit should be installed with lockable devices (health and safety).

Wiring No. x size (mm ²)			
FTC (Master) - Outdoor unit	*2	3 × 1.5 (polar)	
FTC (Master) - Outdoor unit earth	*2	1 × Min. 1.5	
FTC (Master) - Outdoor unit S1 - S2	*3	230V AC	
FTC (Master) - Outdoor unit S2 - S3	*3	24V DC	

*2. Max. 45 m
If 2.5 mm² used, Max. 50 m
If 2.5 mm² used and S3 separated, Max. 80 m

*3. The values given in the table above are not always measured against the ground value.

- Notes:**
1. Wiring size must comply with the applicable local and national codes.
 2. FTC (Master)/outdoor unit connecting cords shall not be lighter than polychloroprene sheathed flexible cord. (Design 60245 IEC 57)
FTC (Master) power supply cords shall not be lighter than polychloroprene sheathed flexible cord. (Design 60227 IEC 53)
 3. Install an earth longer than other cables.
 4. Please keep enough output capacity of power supply for each individual heater. Insufficient power supply capacity might cause chattering.

Option 2: FTC (Master) powered by independent source

If FTC (Master) and outdoor units have separate power supplies, the following requirements MUST be carried out:

- **FTC (Master) unit electrical box connector connections changed.** (see Fig. 4.1.3)
 - **Outdoor unit DIP switch settings changed to SW8-3 ON.**
 - **Turn on the outdoor unit before the FTC (Master).**
 - **Power by independent source is not available for particular models of outdoor unit model.**
- For more detail, refer to the connecting outdoor unit installation manual.

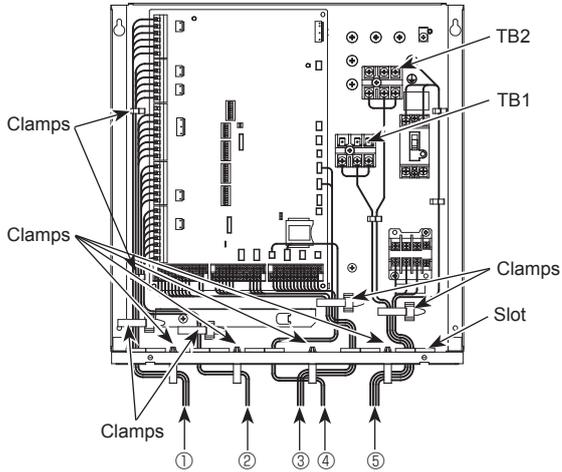

<Fig. 4.1.4> Wiring for PAC-IF062/063B-E

- Notes:
1. Do not run the low voltage cables through a slot that the high voltage cables go through.
 2. Do not run other cables except low voltage cables through a slot that the wireless receiver's cable goes through.
 3. Do not bundle power cables together with other cables.
 4. Bundle cables as figure above by using clamps.

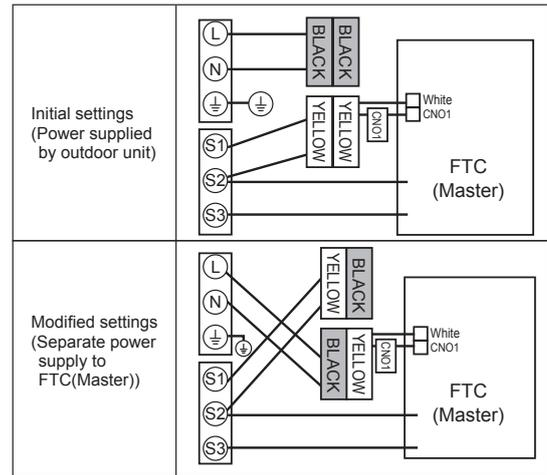

<Fig. 4.1.3>

- ① High voltage cables (OUTPUT)
- ② High voltage cables (OUTPUT)
- ③ Low voltage cables (INPUT) and wireless receiver's cable
- ④ Thermistor cables
- ⑤ Power cables

<1 phase>

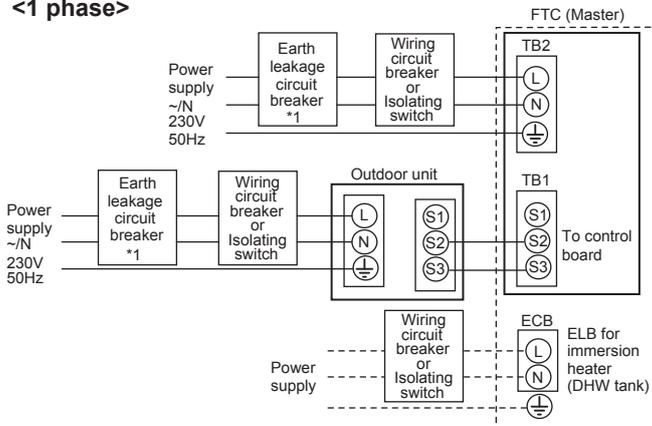

<3 phase>

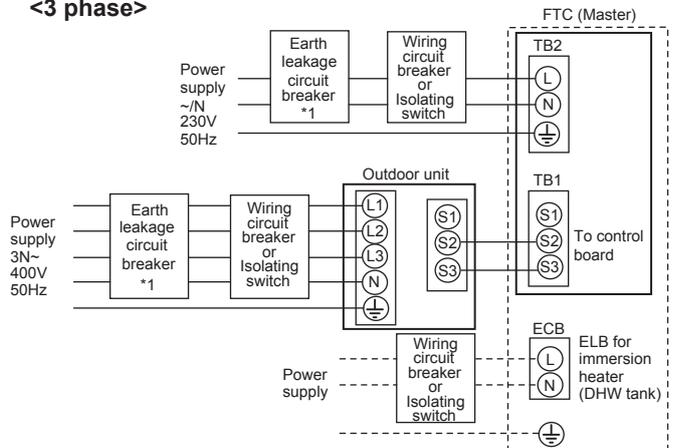

<Fig. 4.1.5> Electrical connections 1 phase/3 phase

□ : PAC-IF061B-E
 □ : PAC-IF062/063B-E

*1 If the installed earth leakage circuit breaker does not have an over-current protection function, install a breaker with that function along the same power line.

A breaker with at least 3.0 mm contact separation in each pole shall be provided. Use earth leakage breaker (NV).

The breaker shall be provided to ensure disconnection of all active phase conductors of the supply.

Note: In accordance with IEE regulations the circuit breaker/isolating switch located on the outdoor unit should be installed with lockable devices (health and safety).

FTC (Master) power supply		~N 230 V 50 Hz
FTC (Master) input capacity	*1	16 A
Main switch (Breaker)		
Wiring No. x size (mm ²)	FTC (Master) power supply	2 × Min. 1.5
	FTC (Master) power supply earth	1 × Min. 1.5
	FTC (Master) - Outdoor unit	*2 2 × Min. 0.3
	FTC (Master) - Outdoor unit earth	—
Circuit rating	FTC (Master) L - N	*3 230V AC
	FTC (Master) - Outdoor unit S1 - S2	*3 —
	FTC (Master) - Outdoor unit S2 - S3	*3 24V DC

*2. Max. 120 m

*3. The values given in the table above are not always measured against the ground value.

- Notes:
1. Wiring size must comply with the applicable local and national codes.
 2. FTC (Master) unit/outdoor unit connecting cords shall not be lighter than polychloroprene sheathed flexible cord. (Design 60245 IEC 57)
 FTC (Master) unit power supply cords shall not be lighter than polychloroprene sheathed flexible cord. (Design 60227 IEC 53)
 3. Install an earth longer than other cables.
 4. Please keep enough output capacity of power supply for each individual heater. Insufficient power supply capacity might cause chattering.

4.2 Connecting the main remote controller

4.2.1 Connect the main remote controller cable to FTC (Master)

Connect the main remote controller cable to 1 and 2 on the terminal block (TBI. 2) on the FTC (Master) controller. <Fig. 4.2.1>

Wiring wire No. × size (mm²): 2 × 0.3 (non polar)

The 10 m wire is attached as an accessory. Max. 500 m

Wiring size must comply with the applicable local and national codes.

Circuit rating: 12V DC

Circuit rating is NOT always against the ground.

Location to place the main remote controller

When using the Remote controller options (refer to section 4.3), place the main remote controller on appropriate location that meets the following points to detect room temperature.

- Do not place the main remote controller in the periphery of a door or a window.
- Do not place the main remote controller near heat or cold sources, such as a radiator or the like.

Notes:

Wiring for main remote controller cable shall be (5 cm or more) apart from power source wiring so that it is not influenced by electric noise from power source wiring. (Do not insert main remote controller cable and power source wiring in the same conduit.) (Refer to Fig. 4.1.1)

When wiring to TBI.2, use the ring type terminals and insulate them from the cables of adjoining terminals.

4.2.2 Installing the main remote controller

1. The main remote controller can be installed either in the switch box or directly on the wall. Perform the installation properly according to the method.

- (1) Secure clearances shown in <Fig. 4.2.2> regardless of whether installing the main remote controller either directly on the wall or in the switch box.
- (2) Prepare the following items in the field.

- Double switch box
- Thin metal conduit
- Locknut and bushing
- Cable cover
- Wall plug

2. Drill an installation hole in the wall.

- Installation using a switch box
 - Drill a hole in the wall for the switch box, and install the switch box in the hole.
 - Fit the conduit tube into the switch box.
- Direct wall installation
 - Drill a cable access hole and thread the main remote controller cable through it.

⚠ Caution:

To prevent entry of dew, water, and insects, seal the gap between the cable and the hole through which the cable is threaded with putty. Otherwise, electric shock, fire, or failure may result.

3. Have the main remote controller ready.

Remove the bottom case from the main remote controller.

4. Connect the main remote controller cable to the terminal block on the bottom case. Modify the main remote controller cable as shown in <Fig. 4.2.5>, and thread the cable from behind the bottom case.

Completely thread the cable to the front so that the unsheathed part of the cable cannot be seen behind the bottom case.

Connect the main remote controller cable to the terminal block on the bottom case.

- Direct wall installation
 - Seal the gap between the cable and the hole through which the cable is threaded.

⚠ Caution

To prevent electric shock or failure, keep the sheath ends or any other foreign objects out of the terminal block.

Do not use ring terminals to connect the wires to the terminal block on the bottom case. The terminals will come in contact with the control board and the front cover, which will result in failure.

Thread the sheath part of the cable to the front.

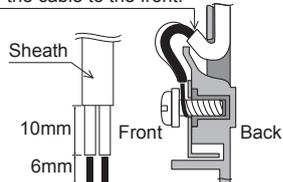

Thread the cable.

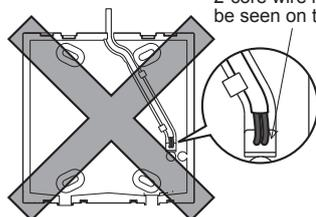

2-core wire must not be seen on the back.

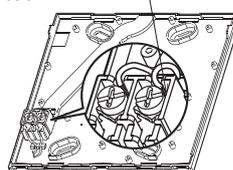

Connect the cable. (non-polarized)
Connect the cable so that the cable sheath is not pinched.

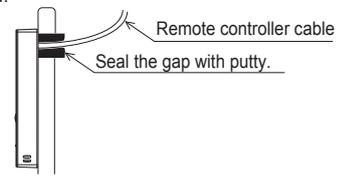

Route the cable from behind the remote controller.

<Fig. 4.2.5>

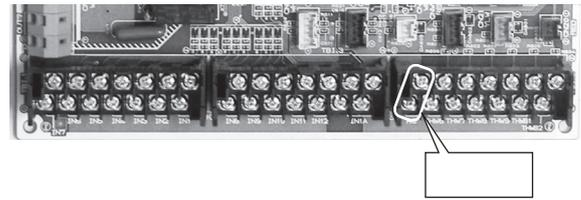

<Fig. 4.2.1>

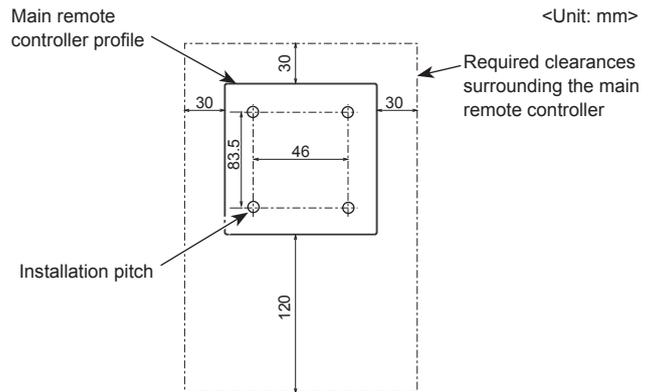

<Fig. 4.2.2>

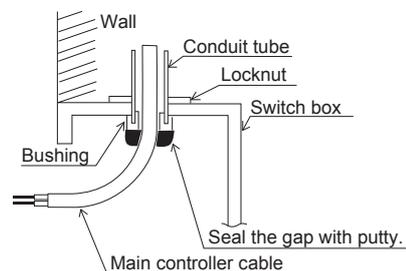

<Fig. 4.2.3>

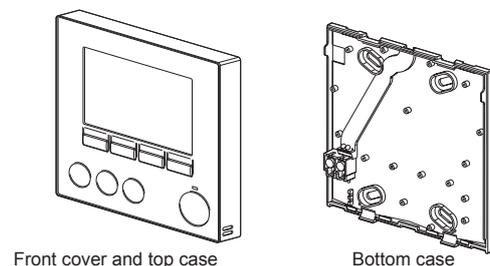

Front cover and top case

Bottom case

<Fig. 4.2.4>

5. Install the bottom case.

- Installation using a switch box
 - When installing the bottom case in the switch box, secure at least two corners of the switch box with screws.

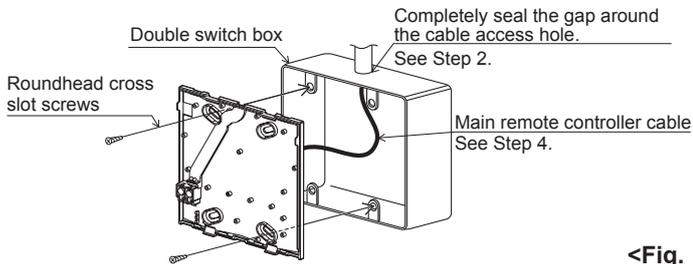

<Fig. 4.2.6>

■ Direct wall installation

- Thread the cable through the slot provided.
- When mounting the bottom case on the wall, secure at least two corners of the main remote controller with screws.
- To prevent the bottom case from lifting, use top-left bottom-right corners of the main remote controller (viewed from the front) to secure the bottom case to the wall with wall plugs or the like.

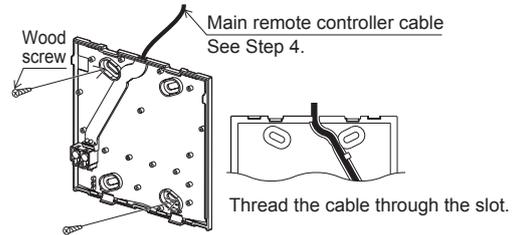

⚠ Caution:

To avoid causing deformation or cracks to the main remote controller, do not overtighten the screws and make an additional installation hole(s).

6. Cut out the cable access hole.

- Direct wall installation
 - Cut out the knockout hole (indicated with grey in <Fig. 4.2.7>) in the front cover by knife or nipper.
 - Thread the main remote controller cable from the slot behind the bottom case through this access hole.

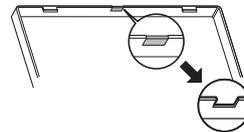

<Fig. 4.2.7>

7. Plug the lead wire cable into the top case.

Plug the lead wire cable coming from the bottom case into the top case.

⚠ Caution:

To avoid failures, do not remove the controller board protective sheet and the controller board from the top case.

After the cable is plugged into the top case, do not hang the top case as shown in <Fig. 4.2.8>. Otherwise, the main remote controller cable could sever, which could cause malfunction to the main remote controller.

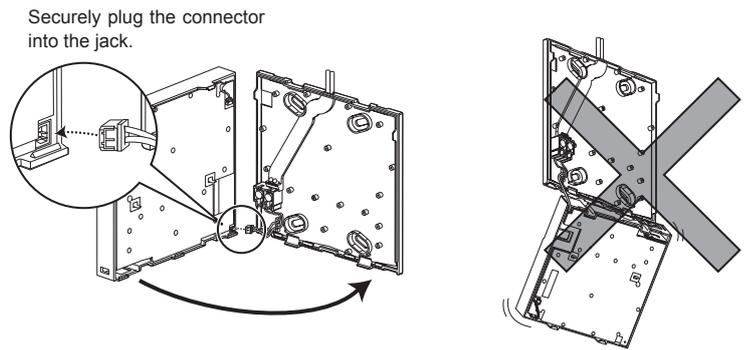

<Fig. 4.2.8>

8. Fit the lead wires into the clamps.

⚠ Caution:

Hold the wires in place with clamps to prevent excessive strain from being applied on the terminal block and causing cable breakage.

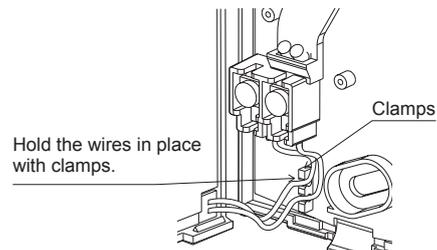

<Fig. 4.2.9>

9. Fit the top case and the front cover onto the bottom case.
 The top case assembly (fitted with the front cover at factory shipment) has two tabs on top. Hook the tabs onto the bottom case and snap the top case onto the bottom case into place. Check that the cover is securely installed.

⚠ Caution:
When the top case is correctly attached to the bottom case a click is heard. If the front cover is not clicked into place it may fall off.

- Direct wall installation (when routing the main remote controller cable along the wall surface)
 - Thread the main remote controller cable through the cable access hole at the top of the main remote controller.
 - Seal the gap between the cable and the access hole with putty.
 - Use a cable cover.

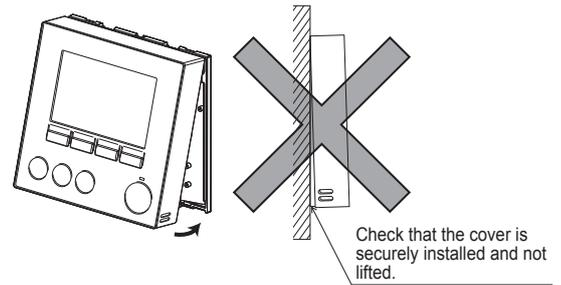

<Fig. 4.2.10>

Seal the gap between the cable and the access hole with putty.
 Use a cable cover.

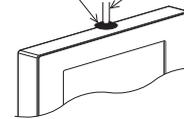

Thread the main remote controller cable through the cable access hole at the top of the main remote controller.

<Fig. 4.2.11>

■ Disassembling the top case and the front cover

- (1) Remove the front cover.
 Insert a flat head screwdriver into either of two open slots at the bottom of the main remote controller and move the screwdriver handle downward as shown. The engagement of the tabs will be released. Then pull the front-cover toward the front to remove the front cover.
- (2) Remove the top case.
 Insert a flat head screwdriver into either of two open slots at the bottom of the main remote controller. The subsequent procedure is the same as that of the front cover.

⚠ Caution:
Use a 5 mm- flat head screwdriver. Do not turn the screwdriver forcibly while placing the blade in the slots. Doing so could break the covers.

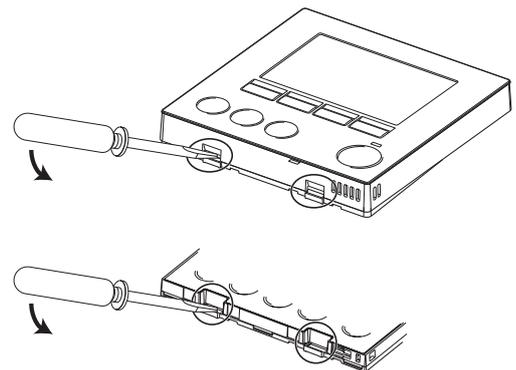

<Fig. 4.2.12>

4.3 Main Remote Controller Options

The FTC (cased) comes factory fitted with a main remote controller. This incorporates a thermistor for temperature monitoring and a graphical user interface to enable set-up, view current status and input scheduling functions. The main remote controller is also used for servicing purposes. This facility is accessed via password protected service menus.

To provide the best efficiency Mitsubishi Electric recommends using automatic adaptation function based on room temperature. To use this function a room thermistor needs to be present in a main living area. This can be done in a number of ways the most convenient are detailed below.

Refer to heating section of this manual for instructions on how to set compensation curve, flow temp. or room temp. (Auto adaptation).

For instructions on how to set the thermistor input for the FTC (Master) please refer to Initial settings section.

The factory setting for space heating mode is set to Room temp. (auto adaptation). If there is no room sensor present in the system, this setting must be changed to either Compensation curve mode or Flow temp. mode.

Note: Auto-adaptation is not available in Cooling mode.

Factory supplied standard

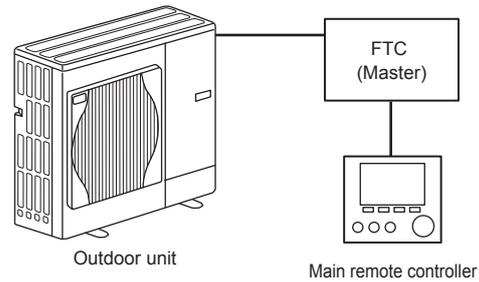

■ 1-zone temperature control

Control option A

This option features the main remote controller and the Mitsubishi Electric wireless remote controller. The wireless remote controller is used to monitor room temperature and can be used to make changes to the space heating settings, boost DHW (*1) and switch to holiday mode without having to directly use the main remote controller.

If more than one wireless remote controller is used, the most recently requested temperature setting will commonly be applied to all rooms by the central control system regardless of which wireless remote controller was used. No hierarchy exists across these remote controllers.

Wire the wireless receiver to FTC (Master) referring to the wireless remote controller instruction manual. **Turn DIP SW1-8 to ON.** Before operation configure the wireless remote controller to transmit and receive data referring to the wireless remote controller installation manual.

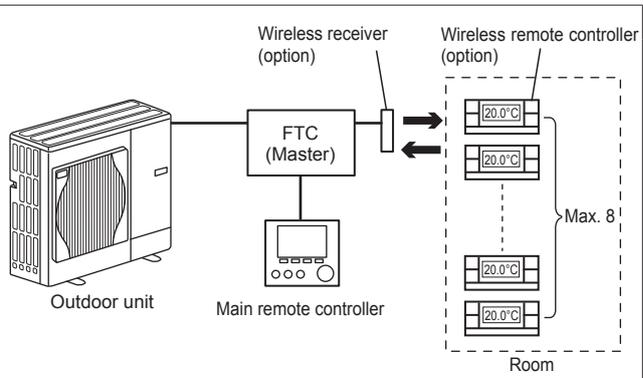

Control option B

This option features the main remote controller and the Mitsubishi Electric thermistor wired to FTC (Master). The thermistor is used to monitor room temperature but can not make any changes in control operation. Any changes to DHW (*1) must be made using the main remote controller mounted on the FTC (Master).

Wire the thermistor to the TH1 connector on FTC (Master). The number of room temperature thermistors that can be connected to FTC (Master) is always one.

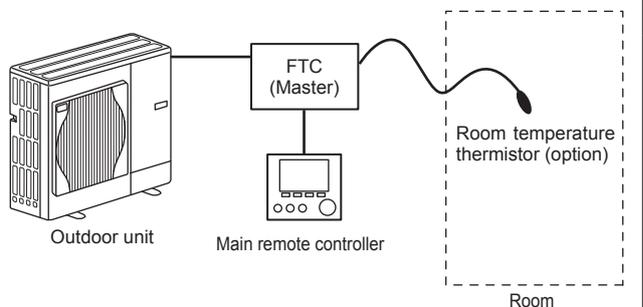

Control option C

This option features the main remote controller being removed from the FTC (Master) and situated in a different room. A thermistor built in the main remote controller can be used for monitoring the room temperature for Auto Adaptation function whilst keeping all its features of the main remote controller available.

The main remote controller and FTC (Master) are connected by a 2-core, 0.3 mm², non-polar cable (local supply) with a maximum length of 500 m.

To use the sensor in the main remote controller, the main remote controller should come off from the FTC (Master). Otherwise it will detect the temperature of the FTC (Master) instead of room temperature. This will affect the output of the space heating.

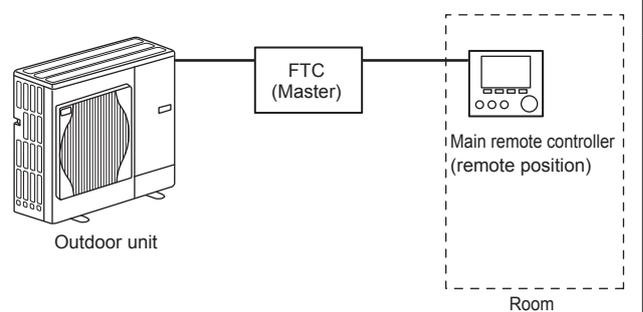

Control option D (Flow temp. or compensation curve only)

This option features the main remote controller and a locally supplied thermostat wired to FTC (Master). The thermostat is used to set the maximum temperature for heating room. Any changes to DHW (*1) must be made using main remote controller mounted on the FTC (Master).

The thermostat is wired to IN1 in TBI.1 on FTC (Master). The number of thermostats that can be connected to FTC (Master) is always one.

The wireless remote controller can be also used as a thermostat.

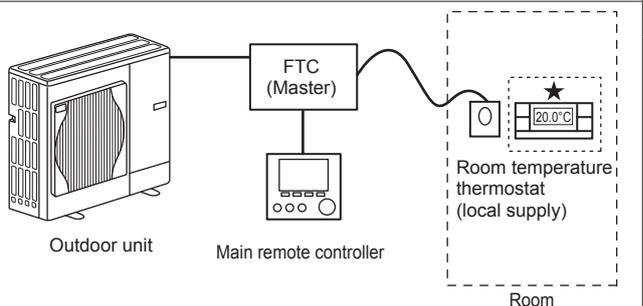

*1 If applicable

Flow temp.controller

2-zone temperature control

Control option A

This option features the main remote controller, the Mitsubishi Electric wireless remote controller and a locally supplied thermostat.

The wireless remote controller is used to monitor the Zone1 room temperature and the thermostat is used to monitor the Zone2 room temperature.

The thermostat can be also allocated to Zone1 and the wireless remote controller to Zone2.

The wireless remote controller can be also used to make changes to the space heating settings, boost DHW (*1) and switch to holiday mode without having to use the main remote controller.

If more than one wireless remote controller is used, the last temperature setting adjustment/demand will be applied to ALL rooms in same zone.

Wire the wireless receiver to FTC (Master) referring to the wireless remote controller instruction manual. Turn DIP SW1-8 to ON. Before operation configure the wireless remote controller to transmit and receive data referring to the wireless remote controller installation manual.

The thermostat is used to set the maximum temperature for heating Zone2 room. The thermostat is wired to IN6 on FTC (Master). (If the thermostat is allocated to Zone1, it is wired to IN1 on TBI.1.) (Refer to 4.5.)

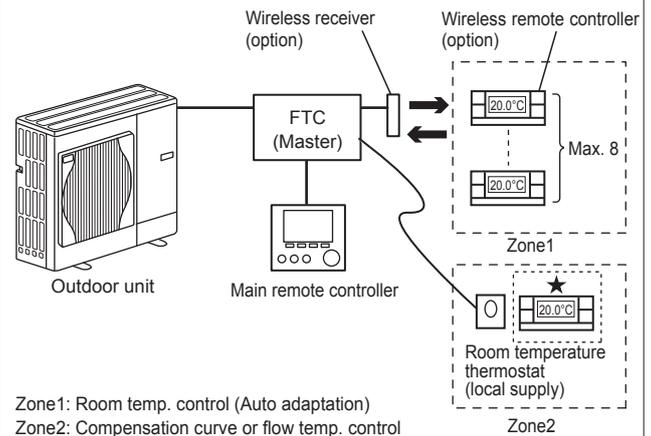

Control option B

This option features the main remote controller, the Mitsubishi Electric thermistor and a locally supplied thermostat that are wired to FTC (Master).

The thermistor is used to monitor the Zone1 room temperature and the thermostat is used to control the Zone2 room temperature.

The thermostat can be also allocated to Zone1 and the thermistor to Zone2.

The thermistor can not make any changes in control operation. Any changes to DHW (*1) must be made using the main remote controller mounted on the FTC (Master).

Wire the thermistor to the TH1 connector on FTC (Master).

The number of room temperature thermistors that can be connected to FTC (Master) is always one.

The thermostat is used to set the maximum temperature for heating Zone2 room. The thermostat is wired to IN6 on FTC (Master). (If the thermostat is allocated to Zone1, wire it to IN1 on TBI.1.) (Refer to 4.5.)

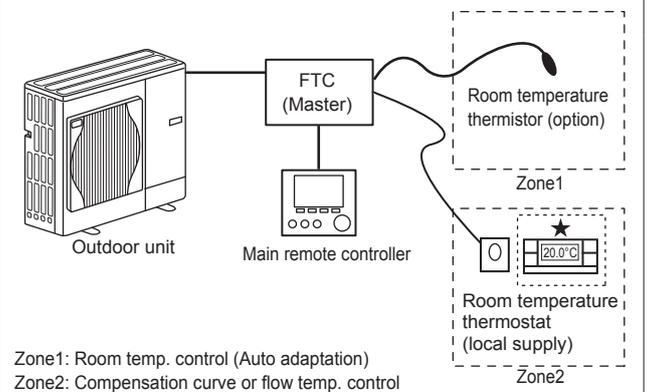

Control option C

This option features the main remote controller (with in-built thermistor) that is removed from the FTC (Master) to monitor the Zone1 room temperature and a locally supplied thermostat to monitor the Zone2 room temperature.

The thermostat can be also allocated to Zone1 and the thermistor to Zone2.

A thermistor built into the main remote controller can be used for monitoring the room temperature for Auto Adaptation function whilst keeping all its features of the main remote controller available.

The main remote controller and FTC (Master) are connected by a 2-core, 0.3 mm², non-polar cable (local supply) with a maximum length of 500 m.

To use the sensor in the main remote controller, the main remote controller should be detached from the FTC (Master). Otherwise it will detect the temperature of the FTC (Master) instead of room temperature. This will affect the output of the space heating.

The thermostat is used to set the maximum temperature for heating Zone2 room. The thermostat is wired to IN6 on FTC (Master). (If the thermostat is allocated to Zone1, wire it to IN1 on TBI.1.) (Refer to 4.5.)

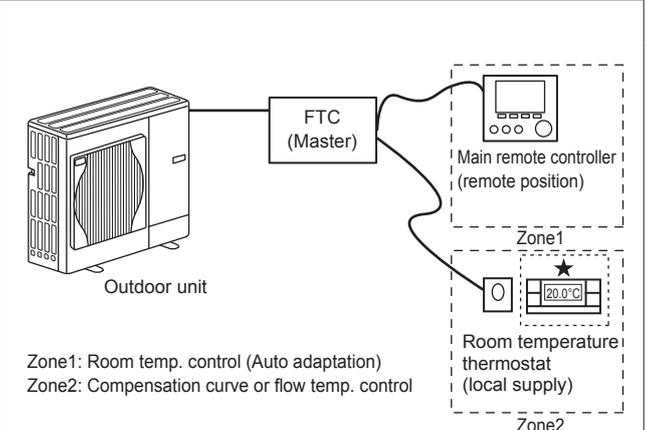

Control option D

This option features the locally supplied thermostats wired to FTC (Master). The thermostats are individually allocated to Zone1 and Zone2. The thermostats are used to set each maximum temperature for heating Zone1 and Zone2 rooms. Any changes to DHW (*1) must be made using the main remote controller mounted on the FTC (Master).

The thermostat for Zone1 is wired to IN1 in TBI.1 on FTC (Master).

The thermostat for Zone2 is wired to IN6 in TBI.1 on FTC (Master).

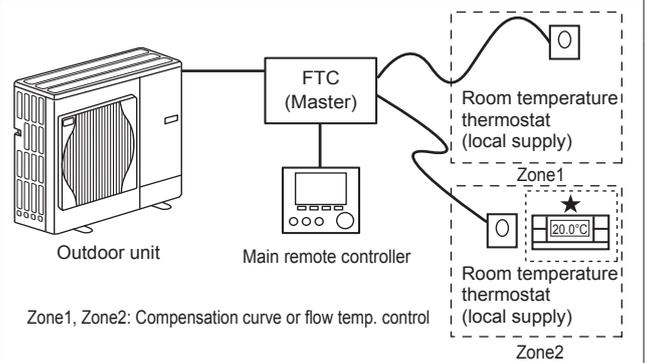

Note: For the options above, the sensor types can be exchanged between Zone1 and Zone2.
 (e.g. Wireless remote controller in Zone1 and Room temp. thermostat in Zone2 can be changed to Room temp. thermostat and wireless remote controller, respectively).
 *1 If applicable
 ★ The wireless remote controller can be also used as a thermostat.

Flow temp.controller

4.4 Connecting the thermistor cables

Connect the thermistor for the FTC (Master) controller.
For multiple outdoor units control with FTC (Slave), see section 9.

4.4.1 Connecting the room temp. thermistor (TH1) cable

TH1 is an optional part (PAC-SE41TS-E).
TH1 is required to use the auto adaptation function. However, when room temperature detection is conducted by the main remote controller or the wireless remote controller (optional), this part is not required.

Connect the TH1 cable to the CN20 connector on FTC (Master).
When the TH1 cable is too long, bundle the excess cable outside the FTC (Master) unit.
For more details, refer to Section 4.3 in this manual or the installation manual that comes with PAC-SE41TS-E.
When using TH1, place this sensor on appropriate location to detect room temperature.

4.4.2. Connecting the refrigerant pipe temp. thermistor (TH2) cable

Connect the TH2 cable to the CN21 connector on FTC (Master).

For split Outdoor unit : Connect TH2.

For packaged Outdoor unit : It is NOT necessary to connect TH2.

When the TH2 cable is too long, bundle the excess cable outside the FTC (Master) unit.
Do not bind the wires in the FTC (Master) unit.

<Thermistor position>

Place TH2 on **refrigerant** piping (**liquid** side).

It is recommended to protect the thermistor with heat insulating materials so as not to be affected by ambient temperature.

Note: Be sure to place TH2 where it correctly detects refrigerant piping temp. (liquid side).

Because;

- (1) TH2 is required to detect heating subcool correctly.
- (2) Refrigerant temperature of water-to-refrigerant heat exchanger also needs to be detected for protection purpose.

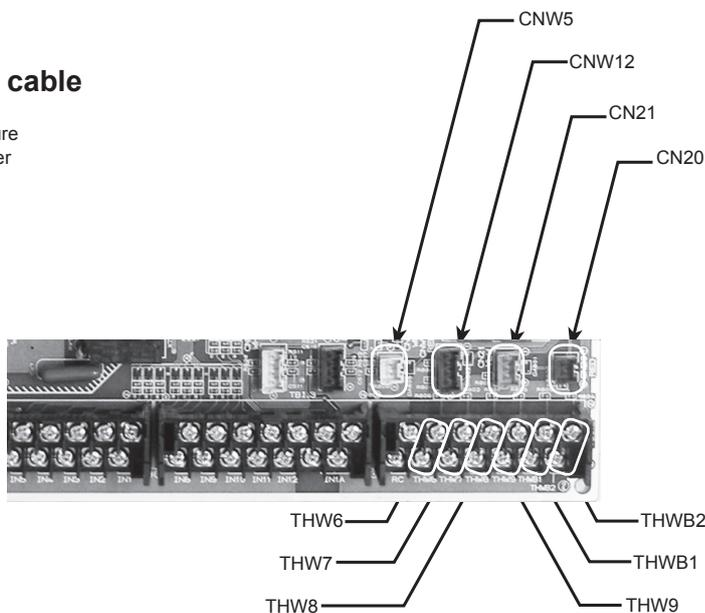

<Fig. 4.4.1>

4.4.3. Connecting the flow water temp. thermistor (THW1) cable and the return water temp. thermistor (THW2) cable

The THW1 and the THW2 cables share a connector, and the connector connects to CNW12 connector on FTC (Master).

When the THW1 and THW2 cables are too long, bundle the excess cables outside the FTC (Master) unit.
Do not bind the wires in the FTC (Master) unit.

<Thermistor position>

Place THW1 on **water** piping (water **outlet** side) after booster heater, and THW2 on the water inlet side.

It is recommended to protect the thermistor with heat insulating materials so as not to be affected by ambient temperature.

Note: Be sure to attach THW1 where it correctly detects Flow temp. (water outlet side). For more details, see Page C-7.

4.4.4. Connecting the actual DHW tank thermistor (THW5) cable

THW5 is an optional part (PAC-TH011TK-E(5 m) or PAC-TH011TKL-E(30 m)). However, PAC-IF063B-E comes with THW5.

Connect the THW5 cable to the CNW5 connector on FTC (Master) if the DHW tank is available.

When the THW5 cable supplied with FTC (Master) is too long, bundle the excess cable outside the FTC (Master) unit.

Do not bind the wires in the FTC (Master) unit.

<Thermistor position>

Place THW5 on the position where tank water temperature can be detected correctly.

It is recommended to position the thermistor at the mid height of the DHW tank (to control DHW heating with this sensor).

It is recommended to protect the thermistor with heat insulating materials so as not to be affected by ambient temperature.

Especially for double (insulated) tank, thermistor should be attached to the inner side (to detect the water temperature).

Note:

Connect the terminals by using the ring terminals and also insulate the cables of adjoining terminals when wiring to TBI.1-3.

The necessary thermistor (THW6, THW7, THW8, THW9) connection for 2-zone temperature control, refer to "4.7 Wiring for 2-zone temperature control".

The necessary thermistor (THWB1, THWB2, THW6, THW7) connection for back-up operation of boiler, refer to the installation manual of PAC-TH011HT-E.

Caution:

Do not route the thermistor cables together with power cables.

The sensor part of the thermistor should be installed where user can not access.

4.4.5. Thermistor position and necessity

<Thermistor position and necessity>

Outdoor unit type	DHW tank	TH2	THW1	THW2	THW5
Split	Present	✓	✓	✓	✓
	Absent	✓	✓	✓	—
Packaged	Present	—	✓	✓	✓
	Absent	—	✓	✓	—

✓ : Necessary. Connect the thermistor.

— : Not necessary. The thermistor is not required, do not connect.

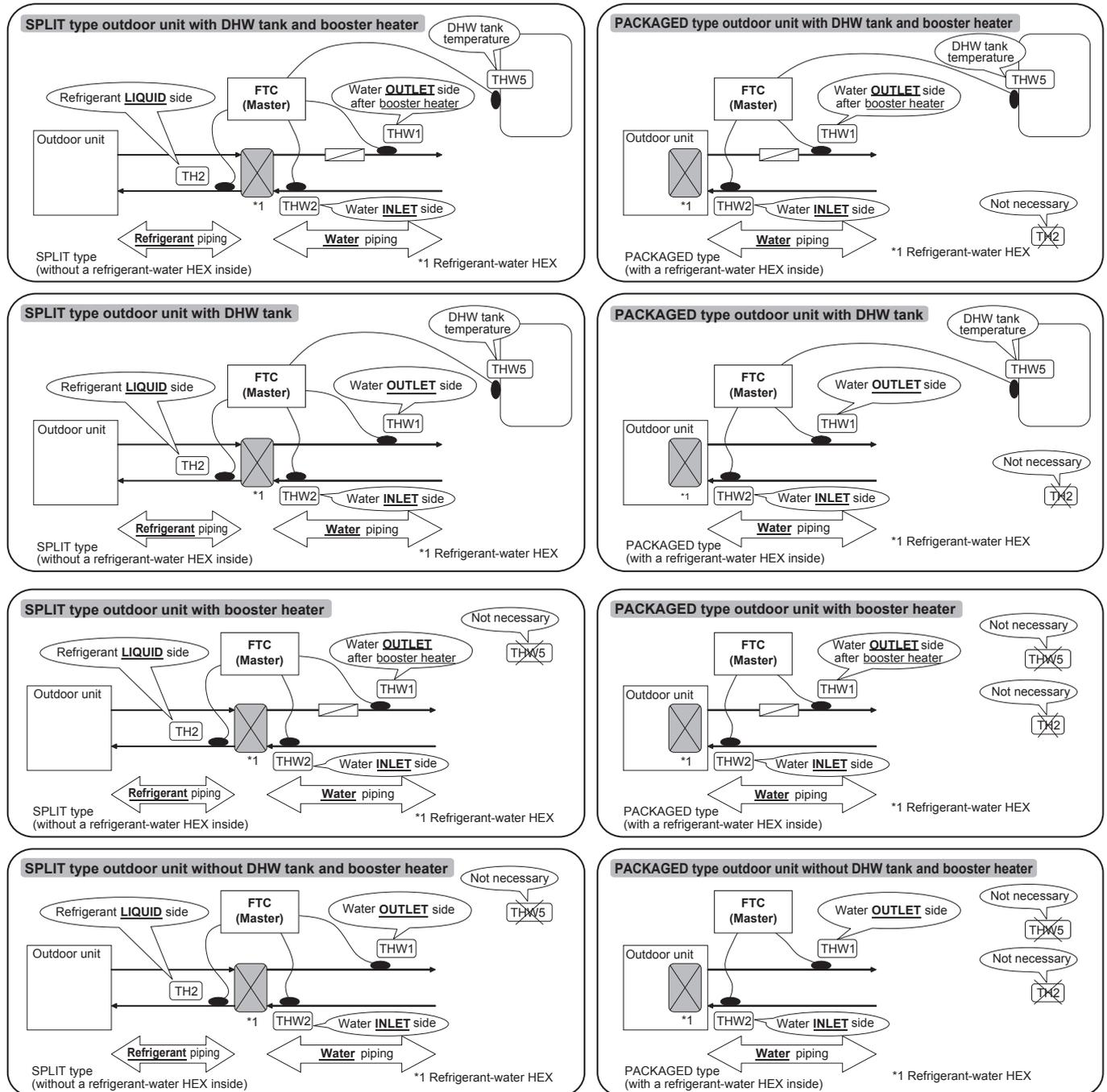

<Fig. 4.4.2>

4.5 Connecting inputs/outputs

For multiple outdoor units control with FTC (Slave), see section 9.

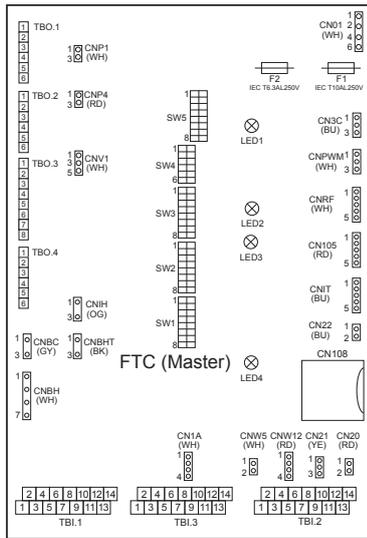

When the wires are wired to adjacent terminals use ring terminals and insulate the wires.

<Fig. 4.5.1>

Flow temp.controller

Signal inputs

Name	Terminal block	Connector	Item	OFF (Open)	ON (Short)
IN1	TBI.1 13-14	—	Room thermostat 1 input *1	Refer to SW2-1 in <5.1 DIP Switch Functions>.	
IN2	TBI.1 11-12	—	Flow switch 1 input	Refer to SW2-2 in <5.1 DIP Switch Functions>.	
IN3	TBI.1 9-10	—	Flow switch 2 input (Zone1)	Refer to SW3-2 in <5.1 DIP Switch Functions>.	
IN4	TBI.1 7-8	—	Demand control input	Normal	Heat source OFF/ Boiler operation *3
IN5	TBI.1 5-6	—	Outdoor thermostat input *2	Standard operation	Heater operation/ Boiler operation *3
IN6	TBI.1 3-4	—	Room thermostat 2 input *1	Refer to SW3-1 in <5.1 DIP Switch Functions>.	
IN7	TBI.1 1-2	—	Flow switch 3 input (Zone2)	Refer to SW3-3 in <5.1 DIP Switch Functions>.	
IN8	TBI.3 1-2	—	Electric energy meter 1	*4	
IN9	TBI.3 3-4	—	Electric energy meter 2		
IN10	TBI.3 5-6	—	Heat meter		
IN11	TBI.3 7-8	—	Smart grid ready input	*5	
IN12	TBI.3 9-10	—			
IN1A	TBI.3 12-14	CN1A	Flow sensor input	*6	

*1. Set the ON/OFF cycle time of the room thermostat for 10 minutes or more; otherwise the compressor may be damaged.

*2. If using outdoor thermostat for controlling operation of heaters, the lifetime of the heaters and related parts may be reduced.

*3. To turn on the boiler operation, use the main remote controller to select "Boiler" in "External input setting" screen in the service menu.

*4. Connectable electric energy meter and heat meter

- Pulse type Voltage free contact for 12VDC detection by FTC (TBI.3 1, 3 and 5 pin have a positive voltage.)
- Pulse duration Minimum ON time: 40ms
Minimum OFF time: 100ms
- Possible unit of pulse 0.1 pulse/kWh 1 pulse/kWh 10 pulse/kWh
100 pulse/kWh 1000 pulse/kWh

Those values can be set by the main remote controller. (Refer to the menu tree in "7.2 Main remote controller".)

*5. As for the smart grid ready, refer to "4.9 Smart grid ready".

*6. Connectable flow sensor

- Power supply 5V DC
- Measuring range 5 to 100 L/min
Those values can be set by the main remote controller. (Refer to <Auxiliary setting> on Page 44.)
- Flow signal 0.5V (at minimum flow rate) to 3.5V (at maximum flow rate)

Wiring specification and local supply parts

Item	Name	Model and specifications
Signal input function	Signal input wire	Use sheathed vinyl coated cord or cable. Max. 30 m Wire type: CV, CVS or equivalent Wire size: Stranded wire 0.13 mm ² to 1.25 mm ² Solid wire: ϕ 0.4 mm to ϕ 1.2 mm
	Switch	Non-voltage "a" contact signals Remote switch: minimum applicable load 12V DC, 1mA

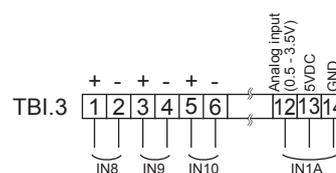

Thermistor inputs

Name	Terminal block	Connector	Item	Optional part model
TH1	—	CN20	Thermistor (Room temp.) (Option) *1	PAC-SE41TS-E
TH2	—	CN21	Thermistor (Ref. liquid temp.) *2	—
THW1	—	CNW12 1-2	Thermistor (Flow water temp.)	—
THW2	—	CNW12 3-4	Thermistor (Return water temp.)	—
THW5	—	CNW5	Thermistor (DHW tank water temp.)	PAC-TH011TK-E(5 m) or PAC-TH011TKL-E(30 m)
THW6	TBI.2 3-4	—	Thermistor (Zone1 flow water temp.) (Option) *1	PAC-TH011-E
THW7	TBI.2 5-6	—	Thermistor (Zone1 return water temp.) (Option) *1	
THW8	TBI.2 7-8	—	Thermistor (Zone2 flow water temp.) (Option) *1	PAC-TH011-E
THW9	TBI.2 9-10	—	Thermistor (Zone2 return water temp.) (Option) *1	
THWB1	TBI.2 11-12	—	Thermistor (Boiler flow water temp.) (Option) *1	PAC-TH011HT-E
THWB2	TBI.2 13-14	—	Thermistor (Boiler return water temp.) (Option) *1	

Ensure to wire thermistor wirings away from the power line and/or OUT1 to 15 wirings.

*1. The maximum length of the thermistor wiring is 30 m. When the wires are wired to adjacent terminals, use ring terminals and insulate the wires.

The length of the optional thermistors are 5 m. If you need to splice and extend the wirings, following points must be carried out.

- 1) Connect the wirings by soldering.
- 2) Insulate each connecting point against dust and water.

*2. Except PAC-IF062/063B-E.

Outputs

Name	Terminal block	Connector	Item	OFF	ON	Signal/Max. current	Max. total current
OUT1	TBO.1 1-2	CNP1	Water circulation pump 1 output (Space heating/cooling & DHW)	OFF	ON	230V AC 1.0A Max.	4.0A (a)
OUT2	TBO.1 3-4	—	Water circulation pump 2 output (Space heating/cooling for Zone1)	OFF	ON	230V AC 1.0A Max.	
OUT3	TBO.1 5-6	—	Water circulation pump 3 output (Space heating/cooling for Zone2) *1 2-way valve 2b output *2	OFF	ON	230V AC 1.0A Max.	
OUT14	—	CNP4	Water circulation pump 4 output (DHW)	OFF	ON	230V AC 1.0A Max.	3.0A (b)
OUT4	TBO.2 4-6	CNV1	3-way valve (2-way valve 1) output	Heating	DHW	230V AC 0.1A Max.	
OUT5	TBO.2 1-2 TBO.2 2-3	—	Mixing valve output *1	Stop	Close Open	230V AC 0.1A Max.	
OUT6	TBO.5 5-6	—	Booster heater 1 output	OFF	ON	230V AC 0.5A Max. (Relay)	
OUT7	TBO.5 7-8	—	Booster heater 2 output	OFF	ON	230V AC 0.5A Max. (Relay)	
OUT8	TBO.4 5-6	—	Cooling signal output	OFF	ON	230V AC 0.5A Max.	
OUT9	TBO.4 3-4	CNIH	Immersion heater output	OFF	ON	230V AC 0.5A Max. (Relay)	
OUT11	TBO.3 3-4	—	Error output	Normal	Error	230V AC 0.5A Max.	
OUT12	TBO.3 5-6	—	Defrost output	Normal	Defrost	230V AC 0.5A Max.	
OUT13	TBO.4 1-2	—	2-way valve 2a output *2	OFF	ON	230V AC 0.1A Max.	
OUT15	TBO.3 7-8	—	Comp ON signal	OFF	ON	230V AC 0.5A Max.	
BC	TBO.5 3-4	—	Booster heater protection output	OFF (BHT open)	ON (BHT short)	230V AC 0.5A Max.	—
OUT10	TBO.3 1-2	—	Boiler output	OFF	ON	non-voltage contact · 220-240V AC (30V DC) 0.5A or less · 10mA 5V DC or more	—
BHT	TBO.5 1-2	CNBHT	Thermostat for booster heater	Thermostat Normal: short	High temp. : open	—	—

Do not connect to the terminals that are indicated as “—” in the “Terminal block” field.

*1 For 2-zone temperature control.

*2 For 2-zone valve ON/OFF control.

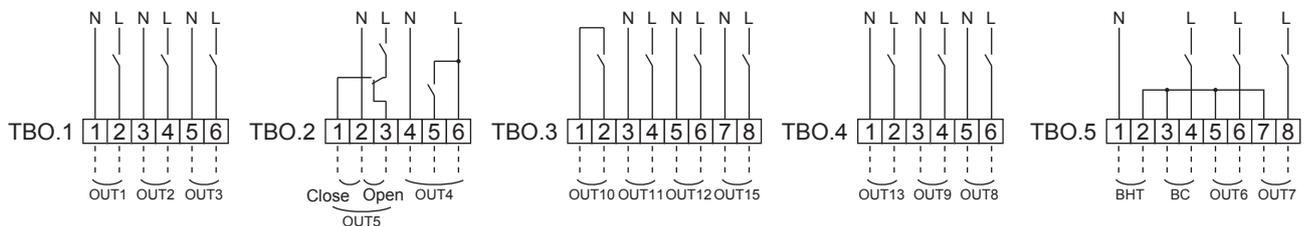

Wiring specification and local supply parts

Item	Name	Model and specifications
External output function	Outputs wire	Use sheathed vinyl coated cord or cable. Max. 30 m Wire type: CV, CVS or equivalent Wire size: Stranded wire 0.25 mm ² to 1.5 mm ² Solid wire: 0.25 mm ² to 1.5 mm ²

How to use TBO.1 to 5

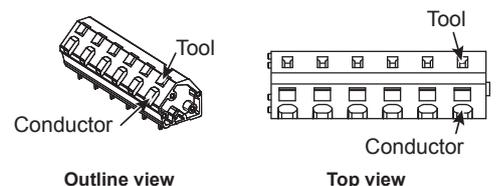

Connect them using either way as shown above.
<Fig. 4.5.2>

Note:

1. When the FTC is powered via outdoor unit, the maximum grand total current of (a)+(b) is 3.0 A.
2. Do not connect multiple water circulation pumps directly to each output (OUT1, OUT2, and OUT3). In such a case, connect them via (a) relay(s).
3. Connect an appropriate surge absorber to OUT10 (TBO.3 1-2) depending on the load at site.
4. Stranded wire should be processed with insulation-covered bar terminal (DIN46228-4 standard compatible type).

4.6 Wiring for heater

<Care to be taken when connecting a booster heater(s)>

The initial setting assumes that the connected booster heater(s) has a built-in direct cut-off thermostat. <Fig. 4.6.1>

When the connected booster heater(s) has a built-in indirect cut-off thermostat, perform wiring according to the following items. < Fig. 4.6.2>

- Connect the thermostat signal to BHT (TBO.5 1-2).
- Remove the jumper wire from connector CNBHT.
- Connect a contactor (or relay) for protecting the booster heater.
(Connect the electromagnetic coil terminals to BC (TBO.5 3-4).

* Do not remove the jumper wire from connector CNBHT when the connected booster heater(s) has a built-in direct cut-off thermostat. < Fig. 4.6.1>

<Care to be taken when connecting an immersion heater>

The initial setting assumes that the connected immersion heater has a built-in direct cut-off thermostat. <Fig. 4.6.3>

<Wiring for booster heater with a built-in direct cut-off thermostat>

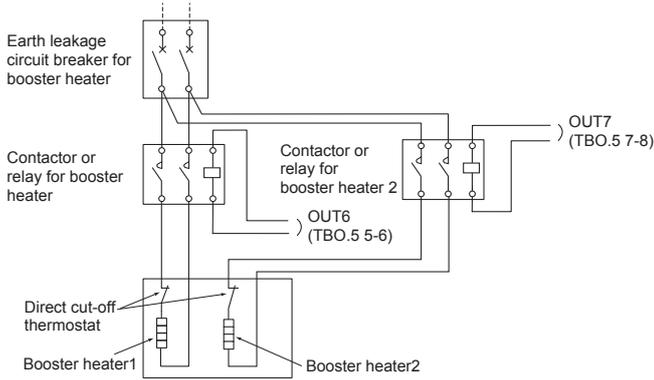

<Fig. 4.6.1>

<Wiring for booster heater with a built-in indirect cut-off thermostat>

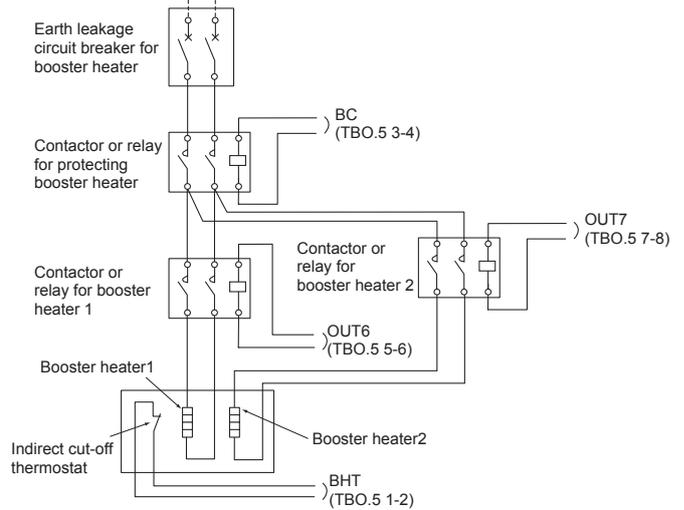

<Fig. 4.6.2>

<Wiring for immersion heater with a built-in direct cut-off thermostat>

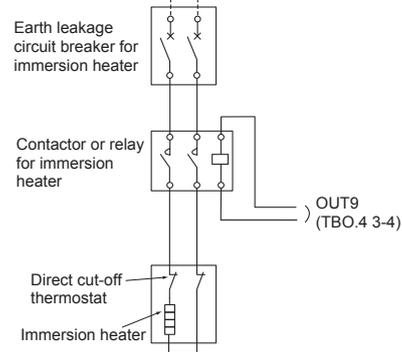

<Fig. 4.6.3>

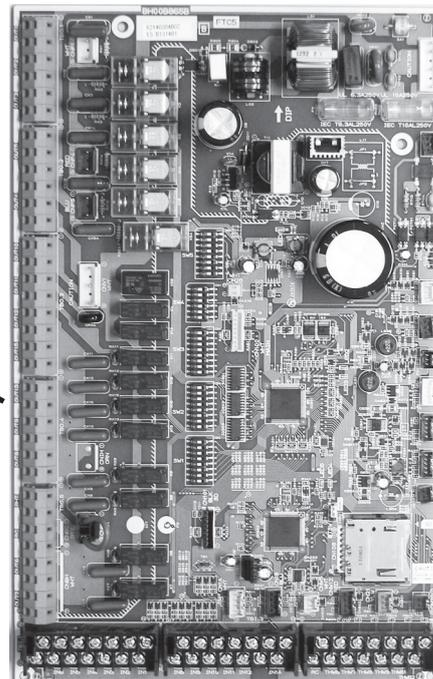
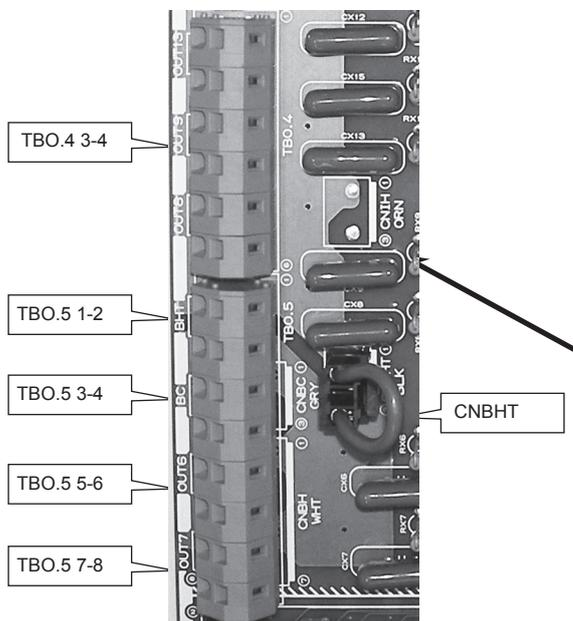

4.7 Wiring for 2-zone temperature control

- Water circulation pump 2 (Zone1 water circulation pump) / Water circulation pump 3 (Zone2 water circulation pump)
Electrically wire water circulation pumps 2 and 3 to the appropriate output terminals. (Refer to "Outputs" in 4.5.)
- Flow switch 2 (Zone1 flow switch) / Flow switch 3 (Zone2 flow switch)
Connect flow switches 2 and 3 to the appropriate terminals. (Refer to "Signal inputs" in 4.5.)
Set dip switches 3-2 and 3-3 according to the functions of individual flow switches 2 and 3. (Refer to "Dip switch setting" in section 5.)
- Thermistor
Connect the thermistor to monitor the Zone1 flow temp. to the THW6 (TBI. 2-3 and 2-4) terminals.
Connect the thermistor to monitor the Zone1 return temp. to the THW7 (TBI. 2-5 and 2-6) terminals.
Connect the thermistor to monitor the Zone2 flow temp. to the THW8 (TBI. 2-7 and 2-8) terminals.
Connect the thermistor to monitor the Zone2 return temp. to the THW9 (TBI. 2-9 and 2-10) terminals.
The maximum length of the thermistor wiring is 30 m. When the wires are wired to adjacent terminals, use ring terminals and insulate the wires.
The length of the optional thermistors are 5 m. If you need to splice and extend the wirings, following points must be carried out.
 - 1) Connect the wirings by soldering.
 - 2) Insulate each connecting point against dust and water.
- Motorized mixing valve
Connect three wires coming from the motorized mixing valve to the appropriate terminals referring to "Outputs" in 4.5.

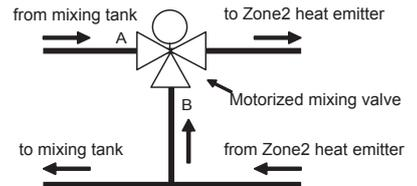
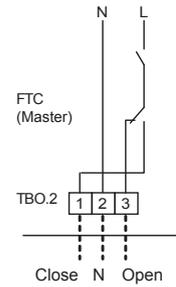

Note: Connect the signal line to open Port A (hot water inlet port) to TBO. 2-3 (Open), the signal line to open Port B (cold water inlet port) to TBO. 2-1 (Close), and the neutral terminal wire to TBO. 2-2 (N).

4.8 2-zone valve ON/OFF control

Opening /closing 2-way valve provides a simple 2-Zone control.
Flow temperature is common for Zone1 and 2.

1. Pipe work

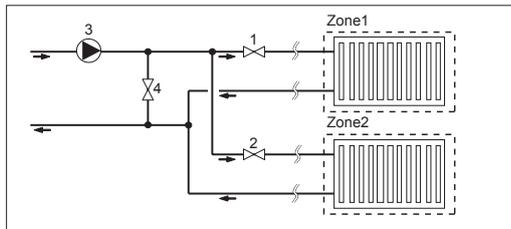

1. Zone1 2-way valve 2a (local supply)
2. Zone2 2-way valve 2b (local supply)
3. Water circulation pump 2 (local supply) *1
4. By-pass valve (local supply) *2

*1 Install according to system in the field.
*2 For safety protection, it is recommended to install a by-pass valve.

Note: Freeze stat function is deactivated whilst this control is ON. Use anti-freeze solution to avoid freezing, if necessary.

2. DIP switch

Turn DIP switch 3-6 ON.

3. 2-way valve 2a (for Zone1) / 2-way valve 2b (for Zone2)

Electrically wire 2-way valve 2a and 2b to the appropriate external output terminals. (Refer to "External outputs" in 4.5)

4. Room thermostat connection

Heating operation mode	Zone1	Zone2
Room temp. control (Auto adaptation) *3	<ul style="list-style-type: none"> • Wireless remote controller (option) • Room temperature thermistor (option) • Main remote controller (remote position) 	<ul style="list-style-type: none"> • Wireless remote controller (option)
Compensation curve or flow temp. control	<ul style="list-style-type: none"> • Wireless remote controller (option) *4 • Room temperature thermostat (local supply) 	<ul style="list-style-type: none"> • Wireless remote controller (option) *4 • Room temperature thermostat (local supply)

*3 Ensure to install the room thermostat for Zone1 in main room since the Room temp. control for Zone1 is prioritized.

*4 The wireless remote controller can be used as a thermostat.

4.9 Smart grid ready

In DHW or heating operation, the commands in the table below can be used.

IN11	IN12	Meaning
OFF (open)	OFF (open)	Normal operation
ON (short)	OFF (open)	Switch-on recommendation*1
OFF (open)	ON (short)	Switch-off command
ON (short)	ON (short)	Switch-on command*2

Note:

- To activate this function, settings on the main remote controller are required. (Main menu → Service → "Function settings" Ref. add: 0, Unit: 1)
- Heating operation mode (compensation curve or flow temp. control) requires the optional wireless remote controller.

*1 Switch-on recommendation has following 2 modes:

Mode 7 Hot water operation

Additional boost temperature is added onto the usual DHW target temperature.
(1-Inactive (default) /2-Target temp. +3°C/3-Target temp. +5°C)

Mode 8 Heating operation

Heating ON (permitted heating with thermo ON) range is extended.
(1-Inactive (default) /2-Thermo ON temp. +2°C/3-Thermo ON temp. +3°C)

*2 Switch-on command has following 2 modes:

Hot water operation

With electrical heater or DIP SW 1-2 ON → Target temp. : 60°C
Without electrical heater and DIP SW 1-2 OFF → Target temp. : 55°C

Heating operation

Heating is ALWAYS permitted.

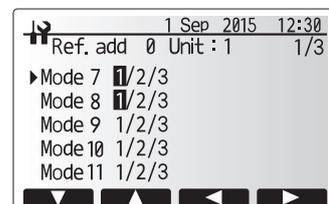
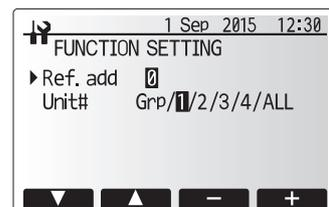
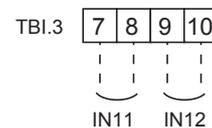

Flow temp.controller

4.10 Installation procedure for DHW tank

Note:

- Be aware that the respective DHW operations are greatly effected by the selections of the components such as tank, immersion heater, or the like.
- Follow your local regulations to perform system configuration.

1. To enable switching of the water circulation circuit between the DHW mode and the heating mode, install a 3-way valve (local supply). The 3-way valve and the DHW tank should be positioned as shown in the system diagram in section 3.
The use of two 2-way valves can perform the same function as a 3-way valve.
2. Install the optional thermistor THW5 (optional part PAC-TH011TK-E(5 m) or PAC-TH011TKL-E(30 m)) on the DHW tank. Note that PAC-IF063B-E comes with THW5.
It is recommended to position the thermistor at the mid point of the DHW tank capacity. Insulate thermistor from ambient air. Especially for double (insulated) tank, thermistor should be attached to the inner side (to detect the water temperature).
3. Connect the thermistor lead to the CNW5 connector on the FTC (Master).
4. The output terminals for the 3-way valve is TBO.2 4-6 (OUT4).
The TBO.2 4-6 terminals on the FTC (Master) are shown in the wiring diagram on the page C-22.
Choose the terminals that the 3-way valve is connected to between TBO.2 4-5, or TBO.2 4-6, according to the rated voltage.
When the rated current of the 3-way valve exceeds 0.1A, be sure to use a relay with maximum voltage and current ratings of 230V AC / 0.1A when connecting to the FTC (Master). Do not directly connect the 3-way valve cable to the FTC (Master). Connect the relay cable to the TBO.2 4-5 terminals. 3-way valve must be of SPST type. SPDT type can NOT be used.
For systems using 2-way valves instead of a 3-way valve please read the following:

Specification of 2-way valve (local supply)

- Power supply: 230V AC
- Current: 0.1A Max. (If over 0.1A you must use a relay)
- Type: Normally closed

	Installation position	Electrical connection terminal block	Output signal		
			Heating	DHW	System OFF
2-way valve1	DHW	TBO.2 4-5	OFF (closed)	ON (open)	OFF (closed)
2-way valve2	Heating	TBO.4 1-2	ON (open)	OFF (closed)	OFF (closed)

Note: Should the 2-way valve become blocked the water circulation will stop.

A by-pass valve or circuit should be installed between pump and 2-way valve for safety.

The TBO.4 1-2 terminals on the FTC (Master) are shown in the wiring diagram.

The 2-way valve (local supply) should be installed according to the instructions supplied with it. Follow 2-way valve's manufacturer's instructions as to whether to connect an earth cable or not.

- For the 2-way valve, choose the one that slowly opens and shuts off to prevent water hammer sound.
- Choose the 2-way valve equipped with manual override, which is necessary for topping up or draining of water.

5. Turn the DIP SW1-3 on the FTC (Master) to ON.

6. When using an immersion heater (local supply), connect a contact relay cable for the immersion heater to TBO.4 3-4 (OUT9), and turn the Dip SW1-4 to ON. Do NOT directly connect the power cable to the FTC (Master).

Note:

- When an immersion heater is installed, select appropriate breaker capacity and a cable with appropriate diameter on the basis of heater output.
- When wiring an immersion heater in the field, always install an earth leakage breaker to prevent accidental electric shock.

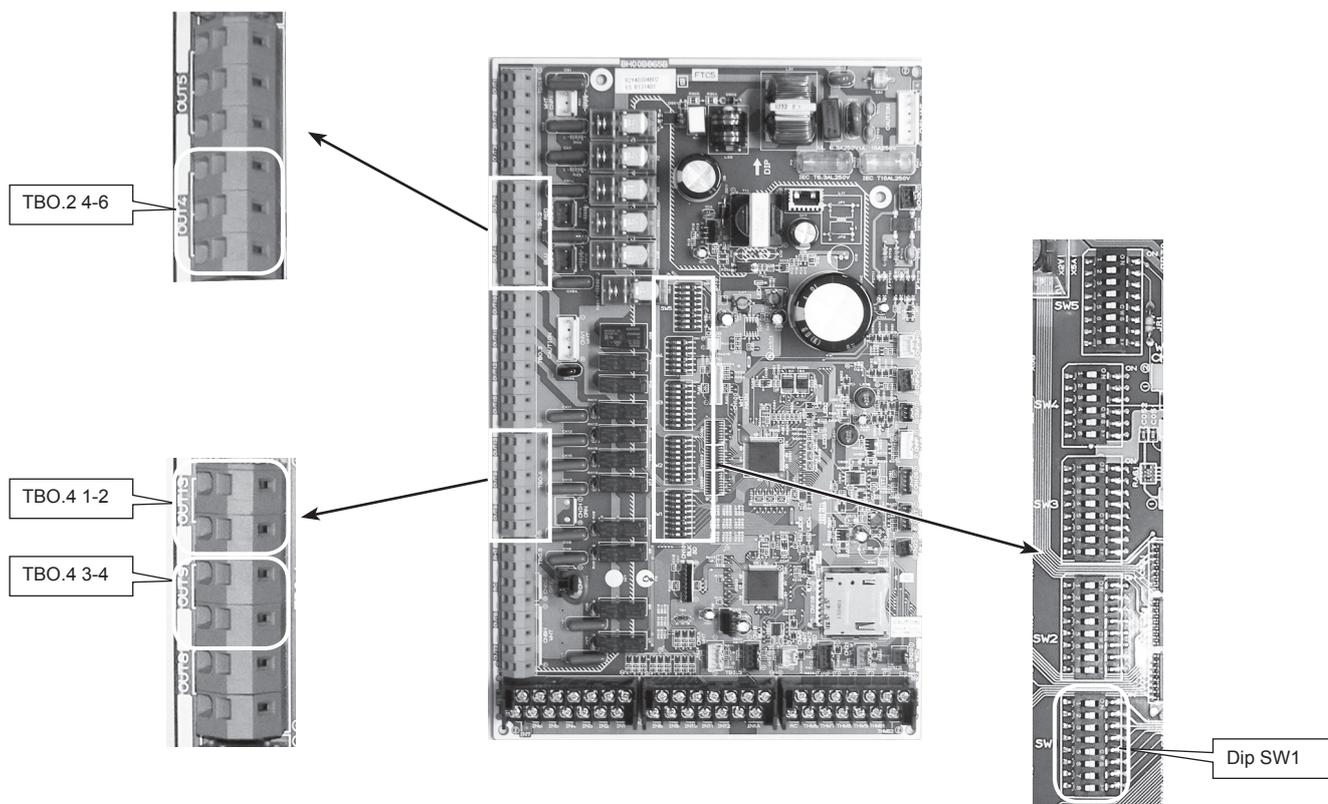

- ⚠ WARNING: When connecting DHW tank**
- (1) Attach the optional thermistor THW5 (PAC-TH011TK-E (5 m) or PAC-TH011TKL-E (30 m)). Note that PAC-IF063B-E comes with THW5.
 - (2) Always use earth leakage breaker when connecting immersion heater.
 - (3) When installing an immersion heater, be sure that the immersion heater has a built-in direct cut-off thermostat.
 - (4) Connect a pressure relief valve on the sanitary water side.

4.11 Using SD memory card

FTC is equipped with an SD memory card interface.
Using an SD memory card can simplify main remote controller settings and can store operating logs. *1

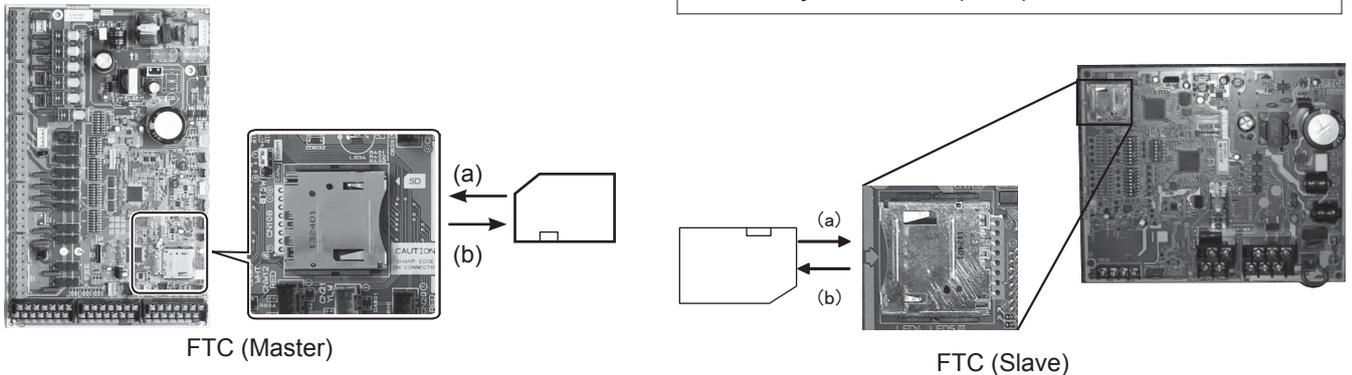

<Handling precautions>

- (1) Use an SD memory card that complies with the SD standards. Check that the SD memory card has a logo on it of those shown to the right.
- (2) SD memory cards to the SD standards include SD, SDHC, miniSD, micro SD, and microSDHC memory cards. The capacities are available up to 32 GB. Choose that with a maximum allowable temperature of 55°C.
- (3) When the SD memory card is a miniSD, miniSDHC, microSD, or micro SDHC memory card, use an SD memory card converter adapter.
- (4) Before writing to the SD memory card, release the write-protect switch.



- (5) Before inserting or ejecting an SD memory card, make sure to power off the system. If an SD memory card is inserted or ejected with the system powered on, the stored data could be corrupted or the SD memory card be damaged. *An SD memory card is live for a whilst after the system is powered off. Before insertion or ejection wait until the LED lamps on the FTC control board are all off.
- (6) The read and write operations have been verified using the following SD memory cards, however, these operations are not always guaranteed as the specifications of these SD memory cards could change.

Manufacturer	Model	Tested in
Verbatim	#44015	Mar. 2012
SanDisk	SDSDB-002G-B35	Oct. 2011
Panasonic	RP-SDP04GE1K	Oct. 2011
Arvato	2GB PS8032 TSB 24nm MLC	Jun. 2012
Arvato	2GB PS8035 TSB A19nm MLC	Jul. 2014
SanDisk	SDSDUN-008G-G46	Oct. 2016
Verbatim	#43961	Oct. 2016
Verbatim	#44018	Oct. 2016

Before using a new SD memory card (including the card that comes with the unit), always check that the SD memory card can be safely read and written to by the FTC controller.

<How to check read and write operations>

- a) Check for correct wiring of power supply to the system. For more details, refer to section 4.1.
(Do not power on the system at this point.)
- b) Insert an SD memory card.
- c) Power on the system.
- d) The LED4 lamp lights if the read and write operations are successfully completed. If the LED4 lamp continues blinking or does not light, the SD memory card cannot be read or written to by the FTC controller.
- (7) Make sure to follow the instruction and the requirement of the SD memory card's manufacturer.
- (8) Format the SD memory card if determined unreadable in step (6). This could make it readable.
Download an SD card formatter from the following site.
SD Association homepage: <https://www.sdcard.org/home/>
- (9) FTC supports FAT file system but not NTFS file system.
- (10) Mitsubishi Electric is not liable for any damages, in whole or in part, including failure of writing to an SD memory card, and corruption and loss of the saved data, or the like. Back up saved data as necessary.
- (11) Do not touch any electronic parts on the FTC control board when inserting or ejecting an SD memory card, or else the control board could fail.

Logos		
Capacities		
2 GB to 32 GB *2		
SD speed classes		
All		

* The SD Logo is a trademark of SD-3C, LLC.
The miniSD logo is a trademark of SD-3C, LLC.
The microSD logo is a trademark of SD-3C, LLC.

*1 To edit main remote controller settings or to check operating data, an Ecodan service tool (for use with PC) is required.
*2 A 2-GB SD memory card stores up to 30 days of operation logs.

5.1 DIP Switch Functions

Located on the FTC printed circuit board are 5 sets of small white switches known as DIP switches. The DIP switch number is printed on the circuit board next to the relevant switches. The word ON is printed on the circuit board and on the DIP switch block itself. To move the switch you will need to use a pin or the corner of a thin metal ruler or similar.

DIP switch settings are listed below in Table 5.1.1.

Only an authorised installer can change DIP switch setting under one's own responsibility according to the installation condition.

Make sure to turn off both indoor unit and outdoor unit power supplies before changing the switch settings.

For multiple outdoor units control with FTC (slave), see section 9.3.2.

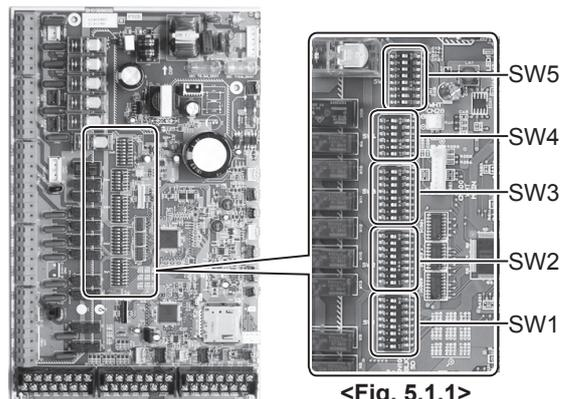

<Fig. 5.1.1>

DIP switch	Function	OFF	ON	Default settings: Indoor unit model
SW1	SW1-1 Boiler	WITHOUT Boiler	WITH Boiler	OFF
	SW1-2 Heat pump maximum outlet water temperature	55°C	60°C	ON *1
	SW1-3 DHW tank	WITHOUT DHW tank	WITH DHW tank	OFF: PAC-IF061B-E ON : PAC-IF062/063B-E
	SW1-4 Immersion heater	WITHOUT Immersion heater	WITH Immersion heater	OFF: PAC-IF061B-E ON : PAC-IF062/063B-E
	SW1-5 Booster heater	WITHOUT Booster heater	WITH Booster heater	OFF
	SW1-6 Booster heater function	For heating only	For heating and DHW	OFF
	SW1-7 Outdoor unit type	Split type	Packaged type	OFF: PAC-IF061B-E ON : PAC-IF062/063B-E
	SW1-8 Wireless remote controller	WITHOUT Wireless remote controller	WITH Wireless remote controller	OFF
SW2	SW2-1 Room thermostat1 input (IN1) logic change	Zone1 operation stop at thermostat short	Zone1 operation stop at thermostat open	OFF
	SW2-2 Flow switch1 input (IN2) logic change	Failure detection at short	Failure detection at open	OFF
	SW2-3 Booster heater capacity restriction	Inactive	Active	OFF
	SW2-4 Cooling mode function	Inactive	Active	OFF
	SW2-5 Automatic switch to backup heat source operation (When outdoor unit stops by error)	Inactive	Active *2	OFF
	SW2-6 Mixing tank	WITHOUT Mixing tank	WITH Mixing tank	OFF
	SW2-7 2-zone temperature control	Inactive	Active *6	OFF
	SW2-8 Flow sensor	WITHOUT Flow sensor	WITH Flow sensor	OFF
SW3	SW3-1 Room thermostat 2 input (IN6) logic change	Zone2 operation stop at thermostat short	Zone2 operation stop at thermostat open	OFF
	SW3-2 Flow switch 2 input (IN3) logic change	Failure detection at short	Failure detection at open	OFF
	SW3-3 Flow switch 3 input (IN7) logic change	Failure detection at short	Failure detection at open	OFF
	SW3-4 Electric energy meter	WITHOUT Electric energy meter	WITH Electric energy meter	OFF
	SW3-5 Heating mode function *3	Inactive	Active	ON
	SW3-6 2-zone valve ON/OFF control	Inactive	Active	OFF
	SW3-7 Heat exchanger for DHW	Coil in tank	External plate HEX	OFF
	SW3-8 Heat meter	WITHOUT Heat meter	WITH Heat meter	OFF
SW4	SW4-1 Multiple outdoor unit control	Inactive	Active	OFF
	SW4-2 Position of multiple outdoor unit control *7	Slave	Master	OFF
	SW4-3	—	—	OFF
	SW4-4 Indoor unit only operation (during installation work) *4	Inactive	Active	OFF
	SW4-5 Emergency mode (Heater only operation)	Normal	Emergency mode (Heater only operation)	OFF *5
	SW4-6 Emergency mode (Boiler operation)	Normal	Emergency mode (Boiler operation)	OFF *5
SW5	SW5-1	—	—	OFF
	SW5-2 Advanced auto adaptation	Inactive	Active	ON
	SW5-3	—	—	OFF
	SW5-4	—	—	OFF
	SW5-5	—	—	OFF
	SW5-6	—	—	OFF
	SW5-7	—	—	OFF
	SW5-8	—	—	OFF

<Table 5.1.1>

- Note:**
- *1. When the FTC unit is connected with a SUHZ-SW outdoor unit of which maximum outlet water temperature is 55°C, DIP SW1-2 must be changed to OFF.
 - *2. External output (OUT11) will be available. For safety reasons, this function is not available for certain errors. (In that case, system operation must be stopped and only the water circulation pump keeps running.)
 - *3. This switch functions only when the cylinder unit is connected with a PUHZ-FRP outdoor unit. When another type of outdoor unit is connected, the heating mode function is active regardless of the fact that this switch is ON or OFF.
 - *4. Space heating and DHW can be operated only in indoor unit, like an electric boiler. (Refer to "5.7 Indoor unit only operation".)
 - *5. If emergency mode is no longer required, return the switch to OFF position.
 - *6. Active only when SW3-6 is set to OFF.
 - *7. SW4-2 is available only when SW4-1 is ON.

5.2 Outdoor unit type

Set Dip SW 1-7 to set the outdoor unit type.

Dip SW 1-7	Setting	Note
OFF	Split type	Necessary to connect TH2
ON	Packaged type	Not necessary to connect TH2

Set Dip SW 1-2 to set the heat pump maximum outlet water temperature.

Dip SW 1-2	Setting
OFF	55°C
ON	60°C

When the outdoor unit is a SUHZ-SW series set the Dip SW1-2 to OFF, other than that, set the Dip SW 1-2 to ON.

Note: When Dip SW 1-2 is OFF (55°C) and an electric heater is not installed (*), 'Legionella Prevention Mode' is NOT available.

* Dip SW settings set when no electric heater is installed.

Dip SW 1-2	Dip SW 1-4	Dip SW 1-5	Dip SW 1-6
OFF	OFF	ON	OFF
OFF	OFF	OFF	(ON/OFF)

5.3 Functions setting

Set Dip SW 1-1 to set whether the system has a boiler.

Dip SW 1-1	Setting
OFF	WITHOUT boiler
ON	WITH boiler

When Dip SW 1-1 is OFF, back-up operation of boiler is not available.

Set Dip SW 1-3 to set whether the system has a DHW tank.

Dip SW 1-3	Setting	Note
OFF	WITHOUT DHW tank	Not necessary to connect THW5
ON	WITH DHW tank	Necessary to connect THW5

When Dip SW 1-3 is OFF, DHW mode is not available.

Set Dip SW 1-4 to set whether the system has an immersion heater.

Dip SW 1-4	Setting
OFF	WITHOUT immersion heater
ON	WITH immersion heater

Set Dip SW 1-5 to set whether the system has a booster heater.

Dip SW 1-5	Setting
OFF	WITHOUT booster heater
ON	WITH booster heater

Set Dip SW 1-6 to set the booster heater function.

Dip SW 1-6	Setting
OFF	For heating only
ON	For heating and DHW

Set Dip SW 2-6 to set whether the system has a mixing tank.

Dip SW 2-6	Setting
OFF	WITHOUT mixing tank
ON	WITH mixing tank

When Dip SW 2-6 is OFF, back-up operation of boiler is not available.

When Dip SW 2-6 is OFF, 2-zone temperature control is not available.

Set Dip SW 2-7 to set activate or deactivate 2-zone temperature control.

Dip SW 2-7	Setting
OFF	Inactive
ON	Active

Set Dip SW 2-8 to set whether the system has a flow sensor.

Dip SW 2-8	Setting
OFF	WITHOUT flow sensor
ON	WITH flow sensor

Set Dip SW 3-4 to set whether the system has an electric energy meter.

Dip SW 3-4	Setting
OFF	WITHOUT electric energy meter
ON	WITH electric energy meter

Set Dip SW 3-6 to set activate or deactivate 2-zone valve ON/OFF control.

Dip SW 3-6	Setting
OFF	Inactive
ON	Active

Set Dip SW 3-7 to set type of the heat exchanger for DHW.

Dip SW 3-7	Setting
OFF	Coil in tank
ON	External plate HEX

Set Dip SW 3-8 to set whether the system has a heat meter.

Dip SW 3-8	Setting
OFF	WITHOUT heat meter
ON	WITH heat meter

Set Dip SW 4-1 to set activate or deactivate multiple units control.

Dip SW 4-1	Setting
OFF	Inactive
ON	Active

When Dip SW 4-1 is OFF, 2-zone temperature control and 2-zone valve ON/OFF control is not available.

Set Dip SW 4-2 to set master or slave of multiple units control.

Dip SW 4-2	Setting
OFF	Slave
ON	Master

When multiple units control is not available, setting of Dip SW 4-2 is not necessary.

Set Dip SW 5-2 to set activate or deactivate advanced auto adaptation.

Dip SW 5-2	Setting
OFF	Inactive
ON	Active

5 DIP Switch setting

Flow temp.controller

<Summary of Function setting>

Dip SW 1-3 (DHW tank)	Dip SW 1-4 (Immersion heater)	Dip SW 1-5 (Booster heater)	Dip SW 1-6 (BH function)	System diagram
ON (WITH DHW tank)	OFF (WITHOUT immersion heater)	ON (WITH booster heater)	ON (For heating and DHW)	
ON (WITH DHW tank)	ON (WITH immersion heater)	ON (WITH booster heater)	ON (For heating and DHW)	
ON (WITH DHW tank)	OFF (WITHOUT immersion heater)	ON (WITH booster heater)	OFF (For heating only)	
ON (WITH DHW tank)	OFF (WITHOUT immersion heater)	OFF (WITHOUT booster heater)	—	
ON (WITH DHW tank)	ON (WITH immersion heater)	ON (WITH booster heater)	OFF (For heating only)	
ON (WITH DHW tank)	ON (WITH immersion heater)	OFF (WITHOUT booster heater)	—	
OFF (WITHOUT DHW tank)	OFF (WITHOUT immersion heater)	ON (WITH booster heater)	OFF	
OFF (WITHOUT DHW tank)	OFF (WITHOUT immersion heater)	OFF (WITHOUT booster heater)	—	

* The use of two 2-way valves can perform same function as a 3-way valve.

Flow temp.controller

5.4 Operation setting

Set Dip SW 1-8 to set whether the system has a wireless remote controller.

Dip SW 1-8	Setting
OFF	WITHOUT wireless remote controller
ON	WITH wireless remote controller

Set Dip SW 2-1 to set the room thermostat 1 input (IN1) logic.

Dip SW 2-1	Setting
OFF	Operation stop at thermostat short
ON	Operation stop at thermostat open

Set Dip SW 2-2 to set the flow switch 1 input (IN2) logic.

Dip SW 2-2	Setting
OFF	Failure detection at short
ON	Failure detection at open

Set Dip SW 2-3 to set the restriction on the capacity of booster heater.

Dip SW 2-3	Setting
OFF	Inactive
ON	Active

When Dip SW 2-3 is ON, booster heater 2 operation is not available. (Only booster heater 1 is available.)

Notes: ① When installing one booster heater, use OUT6 (Booster Heater 1) and switch SW2-3 to ON.

② When installing two booster heaters, use OUT6 (Booster Heater 1) and OUT7 (Booster heater 2). In such cases, use OUT7 (Booster heater 2) to connect the one with higher capacity.

Reference: Summary of Booster heater control

The booster heater is controlled in the following three steps.

		Booster heater 1 (OUT6)	Booster heater 2 (OUT7)
OFF		OFF	OFF
ON	STEP 1	ON	OFF
	STEP 2	OFF	ON
	STEP 3	ON	ON

} Controlled to this extent when SW2-3 is ON.

Set Dip SW 2-4 to set activate or deactivate cooling mode.

Dip SW 2-4	Setting
OFF	Inactive
ON	Active

When Dip SW 2-4 is OFF, cooling mode is not available.

Set Dip SW 2-5 to set the automatic switch to backup heater only operation. (When outdoor unit stops by error.)

Dip SW 2-5	Setting
OFF	Inactive
ON	Active

Set Dip SW 3-1 to set the room thermostat 2 input (IN6) logic.

Dip SW 3-1	Setting
OFF	Operation stop at thermostat short
ON	Operation stop at thermostat open

Set Dip SW 3-2 to set the flow switch 2 input (IN3) logic.

Dip SW 3-2	Setting
OFF	Operation stop at thermostat short
ON	Operation stop at thermostat open

Set Dip SW 3-3 to set the flow switch 3 input (IN7) logic.

Dip SW 3-3	Setting
OFF	Operation stop at thermostat short
ON	Operation stop at thermostat open

Set Dip SW 3-5 to set activate or deactivate heating mode.

Dip SW 3-5	Setting
OFF	Inactive
ON	Active

When the connected outdoor unit is not of PUHZ-FRP model, heating mode is always active regardless of Dip SW3-5 setting.

Set Dip SW 4-4 to set activate or deactivate indoor unit only operation.

Dip SW 4-4	Setting
OFF	Inactive
ON	Active

5.5 Emergency mode (Heater only operation)

The emergency mode is available when a failure on the outdoor unit of the heat pump or a communication error occurs.

This mode uses booster heater or immersion heater as a heat source and automatically controls between the DHW mode and the heating mode. When the system is not incorporated with heater, the emergency mode is not available.

Before starting the emergency mode, turn off the outdoor unit and FTC (Master), and then turn Dip SW 4-5 to ON. Then, turn on FTC (Master) to start the emergency mode. FTC (Master) can be power-supplied by the outdoor unit or directly by power source.

If emergency mode is no longer required, please turn off both outdoor and indoor unit power supply before returning Dip SW4-5 to OFF position.

5.6 Emergency mode (Boiler operation)

The emergency mode is available when a failure on the outdoor unit of the heat pump or a communication error occurs.

This mode uses boiler as a heat source and automatically controls the heating mode. When the system is not incorporated with boiler, the emergency mode is not available.

Before starting the emergency mode, turn off the outdoor unit and FTC (Master), and then turn Dip SW 4-6 to ON. Then, turn on FTC (Master) to start the emergency mode. FTC (Master) can be power-supplied by the outdoor unit or directly by power source.

If emergency mode is no longer required, please turn off both outdoor and indoor unit power supply before returning Dip SW4-6 to OFF position.

5.7 Indoor unit only operation (during installation work)

In the case when DHW or heating operation is required prior to connection of the outdoor unit; i.e. during installation work, an electric heater in indoor unit (*1) can be used.

*1 Model with electric heater only.

*2 Not available during Multiple outdoor unit control.

1. To start operation

- Check if the indoor unit power supply is OFF, and turn DIP switch 4-4 and 4-5 ON.
- Turn ON the indoor unit power supply.

2. To end operation*

- Turn OFF the indoor unit power supply.
- Turn DIP switch 4-4 and 4-5 OFF.

*When the indoor unit only operation is ended, ensure to check over the settings after outdoor unit is connected.

Note:

Prolonged running of the this operation may affect the life of the electric heater.

6.1 Check

After completing installation and the wiring and piping of the local application and outdoor units, check for refrigerant leakage, looseness in the power supply or control wiring, wrong polarity, and power cable is securely connected.
Use a 500-volt megohmmeter to check that the resistance between the power supply terminals and ground is at least 1.0MΩ.

- ⚠ **Warning:**
Do not use the system if the insulation resistance is less than 1.0MΩ.
- ⚠ **Caution:**
Do not carry out this test on the control wiring (low voltage circuit) terminals.

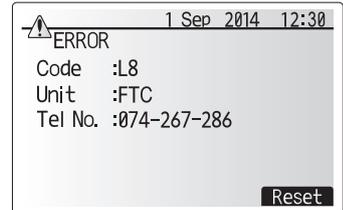

6.2 Self-check

When an error occurs when power is applied or during operation

- Indication of error details
The code, unit, address, and telephone number are displayed.
The telephone number is displayed if registered.
- Resetting the error
Press the F4 (RESET) button, and the F3 (Yes) button to reset the current error.

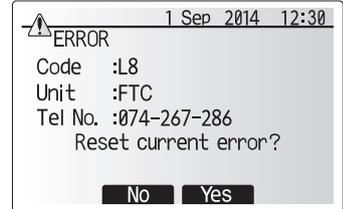

Code	Error	Action
L3	Circulation water temperature overheat protection	Flow rate may be reduced check for; <ul style="list-style-type: none"> • Water leakage • Strainer blockage • Water circulation pump function (Error code may display during filling of primary circuit, complete filling and reset error code.)
L4	DHW tank water temperature overheat protection	Check the immersion heater and it's contactor.
L5	Indoor unit temperature thermistor (THW1, THW2, THW5, THW6, THW7, THW8, THW9) failure	Check resistance across the thermistor.
L6	Circulation water freeze protection	See Action for L3.
L8	Heating operation error	Re-attach any thermistors that have become dislodged.
L9	Low primary circuit flow rate detected by flow sensor or flow switch (flow switches 1, 2, 3)	See Action for L3. If the flow sensor or flow switch itself does not work, replace it. Caution: The pump valves may be hot, please take care.
LC	Boiler circulation water temperature overheat protection	Check if the setting temperature of the Boiler for heating exceeds the restriction. (See the manual of the thermistors "PAC-TH011HT-E".) Flow rate of the heating circuit from the boiler may be reduced. Check for <ul style="list-style-type: none"> • water leakage • strainer blockage • water circulation pump function
LD	Boiler temperature thermistor (THWB1, THWB2) failure	Check resistance across the thermistor.
LE	Boiler operation error	See Action for L8. Check the status of the boiler.
LF	Flow sensor failure	Check flow sensor cable for damage or loose connections.
LH	Boiler circulation water freeze protection	Flow rate of the heating circuit from the boiler may be reduced. Check for <ul style="list-style-type: none"> • water leakage • strainer blockage • water circulation pump function
LJ	DHW operation error (type of external plate HEX)	<ul style="list-style-type: none"> • Check for disconnection of DHW tank water temp. thermistor (THW5). • Flow rate of the sanitary circuit may be reduced. • Check for water circulation pump function.
LL	Setting errors of DIP switches on FTC control board	For boiler operation, check that DIP SW1-1 is set to ON (With Boiler) and DIP SW2-6 is set to ON (With Mixing Tank). For 2-zone temperature control, check DIP SW2-7 is set to ON (2-zone) and DIP SW2-6 is set to ON (With Mixing Tank).
J0	Communication failure between FTC and wireless receiver	Check connection cable for damage or loose connections.
P1	Thermistor (Room temp.) (TH1) failure	Check resistance across the thermistor.
P2	Thermistor (Ref. liquid temp.) (TH2) failure	Check resistance across the thermistor.
P6	Anti-freeze protection of plate heat exchanger	See Action for L3. Check for correct amount of refrigerant.
J1 - J8	Communication failure between wireless receiver and wireless remote controller	Check wireless remote controller's battery is not flat. Check the pairing between wireless receiver to wireless remote controller. Test the wireless communication. (See the manual of wireless system.)
E0 - E5	Communication failure between main remote controller and FTC	Check connection cable for damage or loose connections.
E6 - EF	Communication failure between FTC and outdoor unit	Check that the outdoor unit has not been turned off. Check connection cable for damage or loose connections. Refer to outdoor unit service manual.
E9	Outdoor unit receives no signal from indoor unit.	Check both units are switched on. Check connection cable for damage or loose connections. Refer to outdoor unit service manual.
U*,F*,A*	Outdoor unit failure	Refer to outdoor unit service manual.

Note: To cancel error codes please switch system off (Press button E, on Main remote controller, for 3 seconds).

For description of each LED (LED1 to 3) provided on the FTC, refer to the following table.

LED 1 (Power for microcomputer)	Indicates whether control power is supplied. Make sure that this LED is always lit.
LED 2 (Power for main remote controller)	Indicates whether power is supplied to the main remote controller. This LED lights only in the case of the FTC (Master) unit which is connected to the outdoor unit refrigerant address "0".
LED 3 (Communication between FTC and outdoor unit)	Indicates state of communication between the FTC and outdoor unit. Make sure that this LED is always blinking.

Note (Marking for WEEE)



This symbol mark is for EU countries only.

This symbol mark is according to the directive 2012/19/EU Article 14 Information for users and Annex IX.

Your MITSUBISHI ELECTRIC product is designed and manufactured with high quality materials and components which can be recycled and reused.

This symbol means that electrical and electronic equipment, at their end-of-life, should be disposed of separately from your household waste.

Please, dispose of this equipment at your local community waste collection/recycling centre.

In the European Union there are separate collection systems for used electrical and electronic product.

Please, help us to conserve the environment we live in!

7.1 Safety precautions

FOR USER

- ▶ Before installing the unit, make sure you read all the “Safety Precautions”.
- ▶ The “Safety Precautions” provide very important points regarding safety. Make sure you follow them.
- ▶ Please report to or take consent by the supply authority before connection to the system.

Symbols used in the text

Warning:

Describes precautions that should be observed to prevent danger of injury or death to the user.

Caution:

Describes precautions that should be observed to prevent damage to the unit.

Symbols used in the illustrations

: Indicates a part which must be grounded.

Warning:

- For appliances not accessible to the general public.
- The unit must not be installed by the user. Ask the dealer or an authorized company to install the unit. If the unit is installed improperly, water leakage, electric shock or fire may result.
- Do not stand on, or place any items on the unit.
- Do not splash water over the unit and do not touch the unit with wet hands. An electric shock may result.
- Do not spray combustible gas close to the unit. Fire may result.
- Do not place a gas heater or any other open-flame appliance where it will be exposed to the air discharged from the unit. Incomplete combustion may result.
- Do not remove the front panel or the fan guard from the outdoor unit when it is running.
- When you notice exceptionally abnormal noise or vibration, stop operation, turn off the power switch, and contact your dealer.

- Never insert fingers, sticks etc. into the intakes or outlets.
- If you detect odd smells, stop using the unit, turn off the power switch and consult your dealer. Otherwise, a breakdown, electric shock or fire may result.
- If the supply cable is damaged, it must be replaced by the manufacturer, its service agent or similarly qualified persons in order to avoid a hazard.
- This appliance is not intended for use by persons (including children) with reduced physical, sensory or mental capabilities, or lack of experience and knowledge, unless they have been given supervision or instruction concerning use of the appliance by a person responsible for their safety.
- Children should be supervised to ensure that they do not play with the appliance.
- If the refrigeration gas blows out or leaks, stop the operation of the air conditioner, thoroughly ventilate the room, and contact your dealer.
- Do not install in location that is hot or humid for long periods of time.

Caution:

- Do not use any sharp object to push the buttons, as this may damage the main remote controller.
- Never block or cover the indoor or outdoor unit's intakes or outlets.

Disposing of the unit

When you need to dispose of the unit, consult your dealer.

7.2 Main remote controller

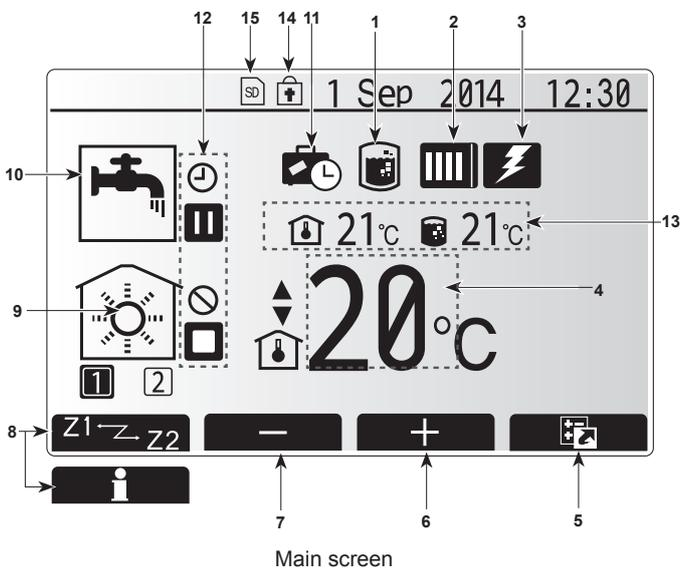
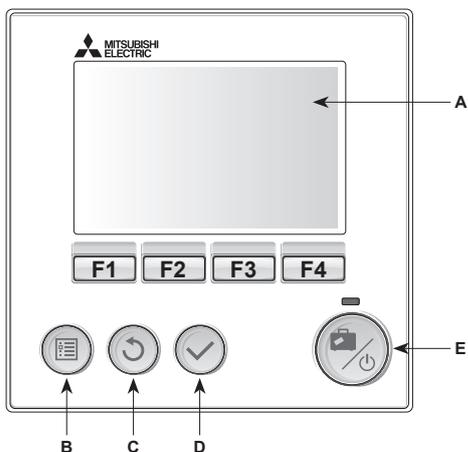

Main screen

<Main remote controller parts>

Letter	Name	Function
A	Screen	Screen in which all information is displayed
B	Menu	Access to system settings for initial set up and modifications.
C	Back	Return to previous menu.
D	Confirm	Used to select or save. (Enter key)
E	Power/Holiday	If system is switched off pressing once will turn system on. Pressing again when system is switched on will enable Holiday Mode. Holding the button down for 3 seconds will turn the system off. (*1)
F1-4	Function keys	Used to scroll through menu and adjust settings. Function is determined by the menu screen visible on screen A.

*1

When the system is switched off or the power supply is disconnected, the system protection functions (e.g. freeze stat. function) will NOT operate. Please beware that without these safety functions enabled the system may potentially become exposed to damage.

<Main screen icons>

	Icon	Description
1	Legionella prevention	When this icon is displayed 'Legionella prevention mode' is active.
2	Heat pump	'Heat pump' is running.
		Defrosting.
		Emergency heating.
3	Electric heater	When this icon is displayed the 'Electric heaters' (booster or immersion heater) are in use.
4	Target temperature	Target flow temperature
		Target room temperature
		Compensation curve
5	OPTION	Pressing the function button below this icon will display the option screen.
6	+	Increase desired temperature.
7	-	Decrease desired temperature.
8	Z1-Z2	Pressing the function button below this icon switches between Zone1 and Zone2.
	Information	Pressing the function button below this icon displays the information screen.
9	Space heating/cooling mode	Heating mode Zone1 or Zone2
		Cooling mode Zone1 or Zone2
10	DHW mode	Normal or ECO mode
11	Holiday mode	When this icon is displayed 'Holiday mode' activated.
12	⌚	Timer
	⊘	Prohibited
	🌐	Server control
	⏸	Stand-by
	⏹	Stand-by (*2)
	⏻	Stop
	▶	Operating
13	Current temperature	Current room temperature
		Current water temperature of DHW tank
14	🔒	The Menu button is locked or the switching of the operation modes between DHW and Heating operations are disabled in the Option screen. (*3)
15	SD	SD memory card is inserted. Normal operation.
		SD memory card is inserted. Abnormal operation.

*2 This unit is in Stand-by whilst other indoor unit(s) is in operation by priority.

*3 To lock or unlock the Menu, press the BACK and CONFIRM keys simultaneously for 3 seconds.

■ Setting the Main remote controller

After the power has been connected to the outdoor and FTC unit (See chapter 4.1) the initial system settings can be entered via the main remote controller.

1. Check all breakers and other safety devices are correctly installed and turn on power to the system.
2. When the main remote controller switched on for the first time, the screen automatically goes to Initial settings menu, Language setting screen and Date/Time setting screen in order.
3. Main remote controller will automatically start up. Wait approximately 6 mins whilst the control menus load.
4. When the controller is ready a blank screen with a line running across the top will be displayed.
5. Press button E (Power) (refer to page C-35) to turn on the system. Before turning on the system, perform initial settings as instructed below.

■ Main Settings Menu

The main settings menu can be accessed by pressing the MENU button. To reduce the risk of untrained end users altering the settings accidentally there are two access levels to the main settings; and the service section menu is password protected.

User Level – Short press

If the MENU button is pressed once for a short time the main settings will be displayed but without the edit function. This will enable the user to view current settings but **NOT** change the parameters.

Installer Level – Long press

If the MENU button is pressed down for 3 seconds the main settings will be displayed with all functionality available. The color of ◀▶ buttons is inverted as per right figure.

The following items can be viewed and/or edited (dependent on access level).

- Domestic Hot water (DHW)
- Heating/Cooling
- Schedule timer
- Holiday mode
- Initial settings
- Service (Password protected)

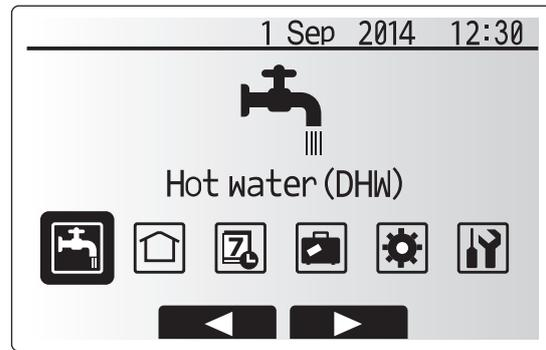

Main menu

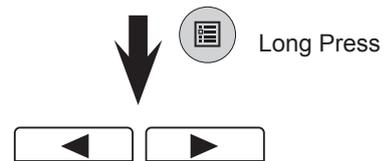

General Operation

- To find the icon that you wish to set, use the F2 and F3 buttons to move between the icons.
- The highlighted icon will appear as a larger version of the center of the screen.
- Press CONFIRM to select and edit the highlighted mode.
- Follow the <Main remote controller Menu Tree> for further setting, using ◀▶ buttons for scrolling or F1 to F4 for selecting.

<Main remote controller Menu Tree>

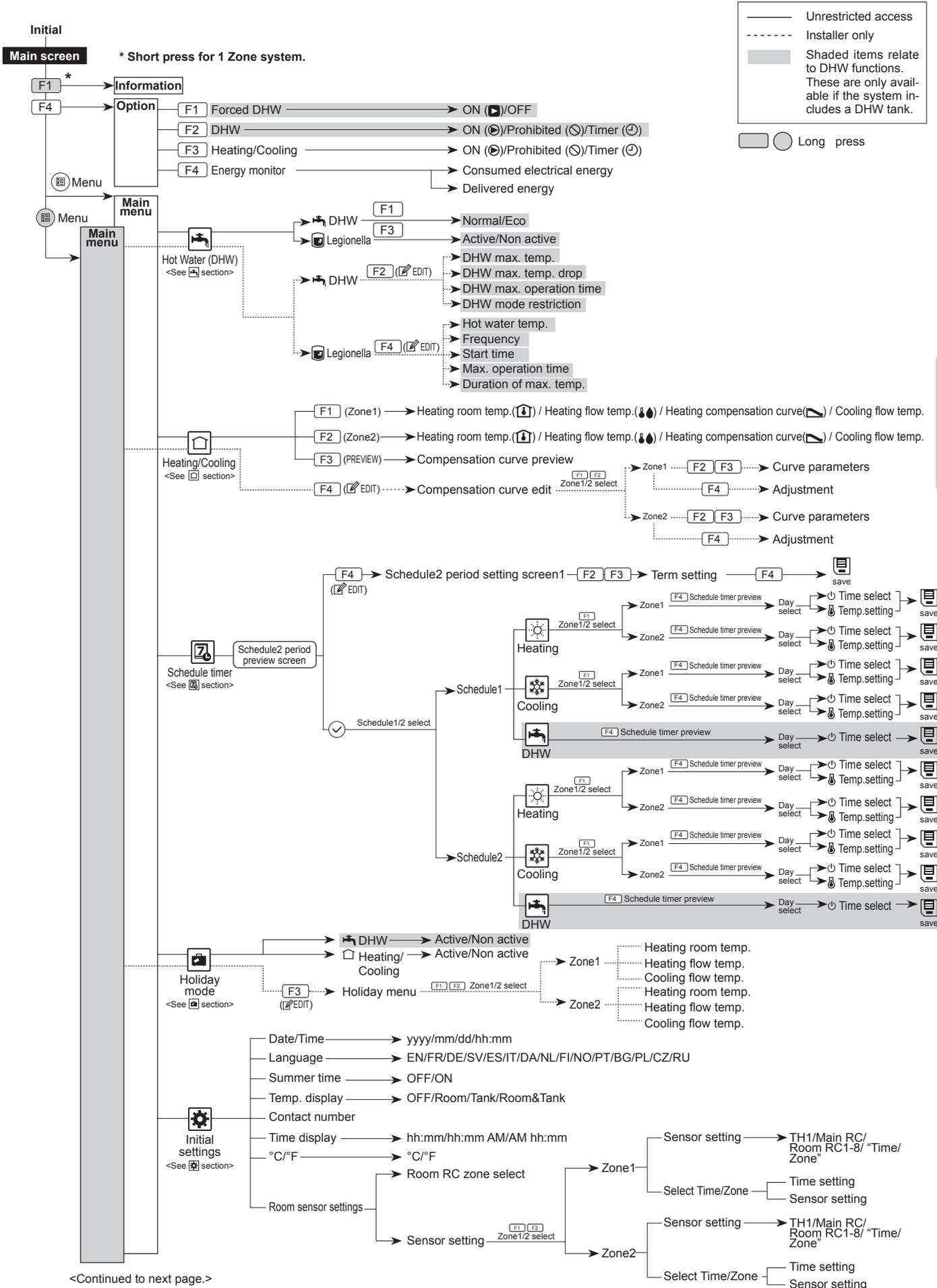

<Continued to next page.>

Flow temp.controller

— Unrestricted access
 - - - - - Installer only
 ■ Shaded items relate to DHW functions. These are only available if the system includes a DHW tank.
 ◻ ◯ Long press

7 Main remote controller operation

Flow temp.controller

<Main remote controller Menu Tree>

<Continued from the previous page.>

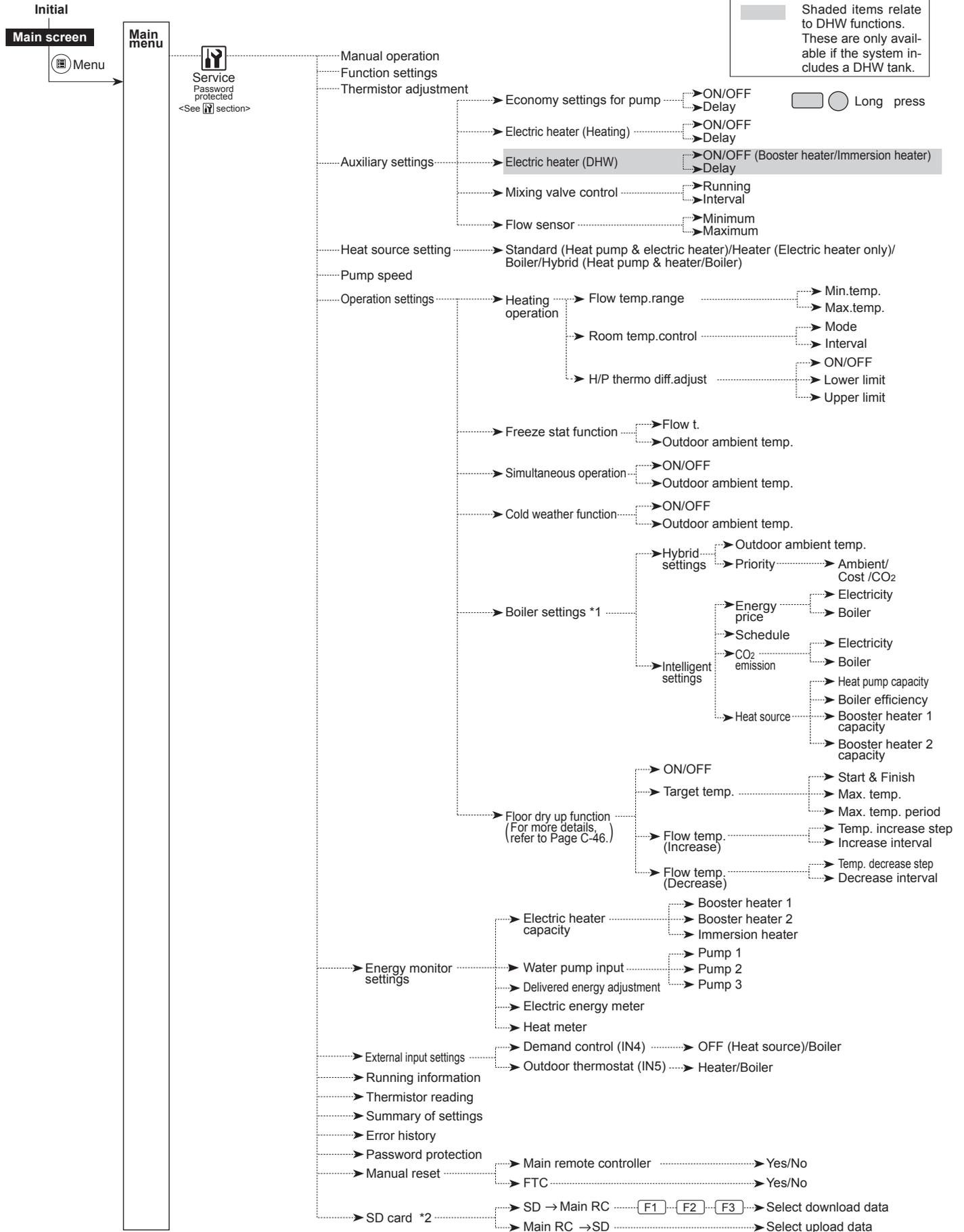

— Unrestricted access
 - - - - - Installer only
 ■ Shaded items relate to DHW functions. These are only available if the system includes a DHW tank.

□ ○ Long press

*1 For more details, refer to the installation manual of PAC-TH011HT-E.

*2 The SD card setting for multiple outdoor units control should be done after turning the power supply of all FTC units (Master/ Slave) ON. If "COMPLETE!" does not appear, it means the operation is not properly completed. Reset the whole system before re-try.

General Operation

In general operation the screen displayed on the main remote controller will be shown as in the figure on the right.

This screen shows the target temperature, space heating mode, DHW mode (if DHW tank is present in system), any additional heat sources being used, holiday mode, and the date and time.

You should use the function buttons to access more information. When this screen is displayed pressing F1 will display the current status and pressing F4 will take the user to the option menu screen.



Home screen

<Option screen>

This screen shows the main operating modes of the system.

Use function buttons to switch between Operating (▶), Prohibited (⊘) and Timer (⌚) for DHW and space heating/cooling, or detailed information on energy or capacity.

The option screen allows quick setting of the following:

- Forced DHW (if DHW tank present) — to turn ON/OFF press F1
- DHW operating mode (if DHW tank present) — to change mode press F2
- Space heating/cooling operating mode — to change mode press F3
- Energy monitor

Following accumulated energy values are displayed.

⚡ : Consumed electric energy in total (month-to-date)

🔥 : Produced heat energy in total (month-to-date)

To monitor the energy values in each operation mode for [month-to-date/ last month/ the month before last/ year-to-date/ last year], press F4 to access to the Energy monitor menu.

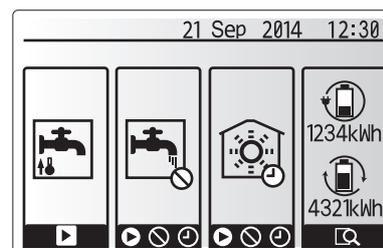

Option screen

Note:

If a certain accuracy is required for the monitoring, the method to display captured data from external energy meter(s) should be set up. Contact your installer for further details.

Main Settings Menu

To access the main settings menu press button B 'MENU'

The following menus will be displayed;

- DHW (FTC unit plus locally supplied DHW tank)
- Heating/Cooling
- Schedule timer
- Holiday mode
- Initial settings
- Service (Password protected)

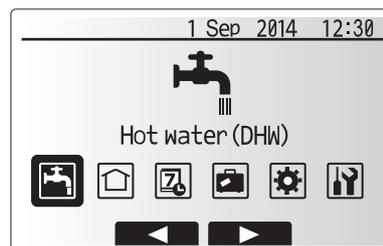

Main settings menu screen

Initial Settings

1. From the main settings menu use F2 and F3 buttons to highlight 'Initial settings' icon and select by pressing CONFIRM.
2. Use F1 and F2 buttons to scroll through the menu list. When the required title is highlighted then press CONFIRM to edit.
3. Use the relevant function buttons to edit each initial setting then press CONFIRM to save the setting.

Initial settings that can be edited are

- Date/Time *Be sure to set it to the local standard time.
- Language
- Summer time
- Temp. display
- Contact number
- Time display
- °C/°F
- Room sensor settings

To return to the main settings menu press the BACK button.

Icon	Description
	Hot water (DHW)
	Heating/Cooling
	Schedule timer
	Holiday mode
	Initial settings
	Service

<Room sensor settings>

For room sensor settings it is important to choose the correct room sensor depending on the heating mode the system will operate in.

1. From the Initial settings menu select Room sensor settings.

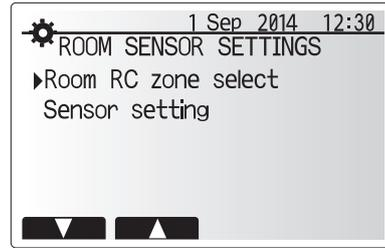

2. When 2-zone temperature control is active and wireless remote controllers are available, from Room RC zone select screen, select zone no. to assign to each remote controller.

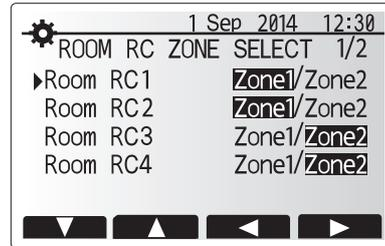

3. From Sensor setting screen, select a room sensor to be used for monitoring the room temperature from Zone1 and Zone2 separately.

Control option ("Remote Controller Options" (Installation manual))	Corresponding initial settings room sensor	
	Zone1	Zone2
A	Room RC1-8 (one each for Zone1 and Zone2)	*
B	TH1	*
C	Main remote controller	*
D	*	*

* Not specified (if a field-supplied room thermostat is used)
Room RC1-8 (one each for Zone1 and Zone2) (if a wireless remote controller is used as a room thermostat)

4. From Sensor setting screen, select Time/Zone to make it possible to use different room sensors according to the time schedule set in the Select Time/Zone menu. The room sensors can be switched up to 4 times within 24 hours.

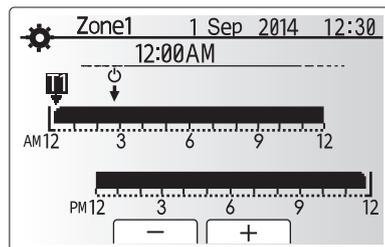
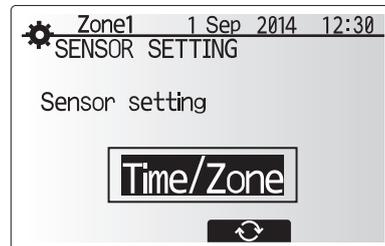
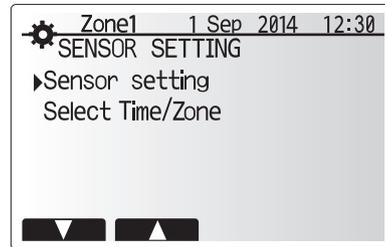

Time/Zone schedule setting screen

Flow temp.controller

Domestic Hot Water (DHW)/Legionella Prevention

The domestic hot water and legionella prevention menus control the operation of DHW tank heat ups.

<DHW mode settings>

1. Highlight the hot water icon and press CONFIRM.
2. Use button F1 to switch between Normal and ECO heating modes.
3. To edit the mode, press down the MENU button for 3 seconds, then select "hot water".
4. Press F2 key to display the HOTWATER (DHW) SETTING menu.
5. Use F2 and F3 keys to scroll through the menu selecting each component in turn by pressing CONFIRM. See the table below for description of each setting.
6. Enter the desired number using the function keys and press CONFIRM.

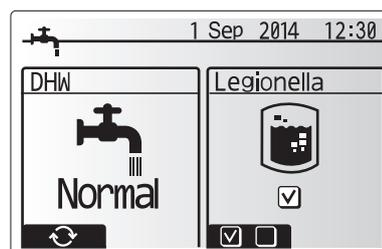

Menu subtitle	Function	Range	Unit	Default value
DHW max. temp.	Desired temperature of stored hot water	40 - 60	°C	50
DHW max. temperature drop	Difference in temperature between DHW max. temp. and the temperature at which DHW mode restarts	5 - 30	°C	10
DHW max. operation time	Max. time allowed for stored water heating DHW mode	30 - 120	min	60
DHW mode restriction	The time period after DHW mode when space heating has priority over DHW mode temporarily preventing further stored water heating (Only when DHW max. operation time has passed.)	30 - 120	min	30

If you wish to make changes contact installer.

Explanation of DHW operation

- When the DHW tank temperature drops from "DHW max. temp." by more than the "DHW max. temperature drop" (set by installer), DHW mode operates and the flow from the primary heating/cooling circuit is diverted to heat the water in the DHW tank.
- When the temperature of the stored water reaches the 'DHW max. temp.' set by the installer or if the 'DHW max. operation time' set by the installer is exceeded DHW mode ceases to operate.
- Whilst DHW mode is in operation primary hot water is not directed to the space heating/cooling circuit.
- Directly after DHW max. operation time 'DHW mode restriction' will routinely operate. The duration of this feature is set by the installer and during its operation, DHW mode can not (normally) be reactivated, allowing time for the system to deliver primary hot water to the space heating/cooling if required. However, if at this time there is no current demand for space heating/cooling, the system will automatically resume DHW mode. This will continue until it receives a demand for space heating.
- After the 'DHW mode restriction' operation the DHW mode can operate again and DHW tank heating will continue according to system demand.

<Eco mode>

DHW mode can run in either 'Normal' or 'Eco' mode. Normal mode will heat the water in the DHW tank more quickly using the full power of the heat pump. Eco mode takes a little longer to heat the water in the DHW tank but the energy used is reduced. This is because heat pump operation is restricted using signals from the FTC based on measured DHW tank temperature.

Note: The actual energy saved in Eco mode will vary according to outdoor ambient temperature.

Return to the DHW/legionella prevention menu.

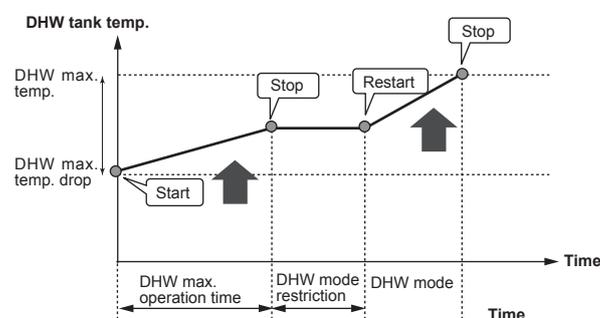
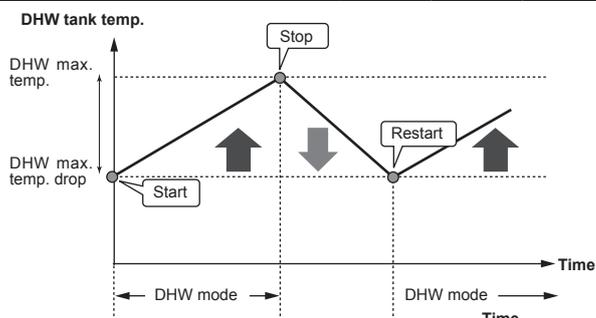

Legionella Prevention Mode settings (LP mode)

1. Use button F3 to choose legionella mode active YES/NO.
2. To edit the legionella function, press down the MENU button for 3 seconds and select "hot water", then press F4 key.
3. Use F1 and F2 keys to scroll through the menu selecting each subtitle in turn by pressing CONFIRM. See the table below for description of each setting.
4. Enter the desired number using the function keys and press CONFIRM.

During Legionella Prevention Mode the temperature of the stored water is increased above 60°C to inhibit legionella bacterium growth. It is strongly recommended that this is done at regular intervals. Please check local regulations for the recommended frequency of heat ups.

Note: When failures occur on the FTC unit, the LP mode may not function normally.

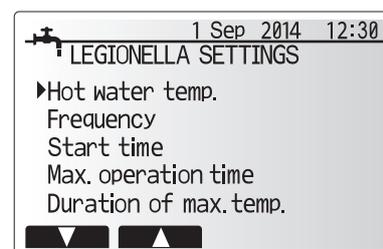

Menu subtitle	Function	Range	Unit	Default value
Hot water temp.	Desired temp. of stored hot water	60-70	°C	65
Frequency	Time between LP mode DHW tank heat ups	1-30	day	15
Start time	Time when LP mode will begin	0:00-23:00	-	03:00
Max. operation time	Maximum time allowed for LP mode DHW tank heat	1-5	hour	3
Duration of max. temp.	The time period after LP mode max. water temp. has been reached	1-120	min	30

If you wish to make changes contact installer.

Explanation of Legionella Prevention Mode operation

- At the time entered by the installer 'Start time' flow of useful heat from the system is diverted to heat the water in the DHW tank.
- When the temperature of the stored water exceeds the 'Hot Water temp.' set by the installer (above 65°C) primary circuit water is no longer diverted to heat the DHW tank.
- Whilst LP mode is in operation hot water is not directed to the space heating / cooling circuit.
- Directly after LP mode operation 'Duration of max. temp.' will operate. The duration of this feature is set by the installer and during its operation stored water temperature will be monitored.
- If stored water temperature should drop to LP restart temp., LP mode will restart and primary water flow from the heat source(s) will be directed to the DHW tank to boost the temperature. Once the set time for Duration of Max. temp. has passed LP mode will not recur for the set interval (set by installer).
- It is the responsibility of the installer to ensure the settings for legionella prevention are compliant with local and national guidelines.

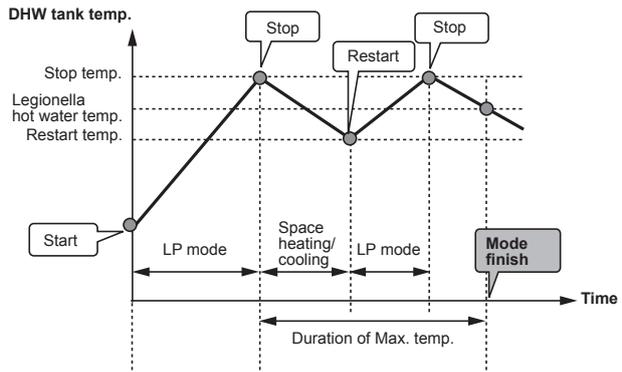

(LP mode: Legionella Prevention mode)

Please note that LP mode uses the assistance of electric heaters (if present) to supplement the energy input of the heat pump. Heating water for long periods of time is not efficient and will increase running costs. The installer should give careful consideration to the necessity of legionella prevention treatment whilst not wasting energy by heating the stored water for excessive time periods. The end user should understand the importance of this feature. **ALWAYS COMPLY WITH LOCAL AND NATIONAL GUIDANCE FOR YOUR COUNTRY REGARDING LEGIONELLA PREVENTION.**

Forced DHW

The forced DHW function is used to force the system to operate in DHW mode. In normal operation the water in the DHW tank will be heated either to the set temperature or for the maximum DHW time, whichever occurs first. However should there be a high demand for hot water 'Forced DHW' function can be used to prevent the system from routinely switching to space heating/cooling and continue to provide DHW tank heating.

Forced DHW operation is activated by pressing button F1 and Back button in the 'Option Screen'. After DHW operation finishes, the system will automatically return to normal operation. To cancel forced DHW operation hold down button F1 in the 'Option Screen'.

Heating/Cooling

The heating/cooling menus deal with space heating/cooling using normally either a radiator, fan-coil, or underfloor heating/cooling system depending on the installation.

There are 3 heating modes

- Heating room temp. (Auto adaptation) (🏠)
- Heating flow temp. (💧)
- Heating compensation curve (📈)
- Cooling flow temp. (💧)

<Room temp. (Auto adaptation) mode>

In room temp. (Auto adaptation) mode the controller uses temperature sensors around the heating system to monitor space and flow temperatures. This data is regularly updated and compared to previous data by the controller to predict changes in room temperature and adjust the temperature of water flowing to the space heating circuit accordingly. By monitoring not only the outdoor ambient, but the room and heating circuit water temperatures, the heating is more consistent and sudden spikes in required heat output are reduced. This results in a lower overall flow temperature being required.

<Flow temp. mode>

The temperature of the water flowing to the heating circuit is set by the installer to best suit the space heating/cooling system design, and user's desired requirements.

Explanation of compensation curve

During late spring and summer usually the demand for space heating is reduced. To prevent the heat pump from producing excessive flow temperatures for the primary circuit the compensation curve mode can be used to maximise efficiency and reduce running costs.

The compensation curve is used to restrict the flow temperature of the primary space heating circuit dependent on the outdoor temperature. The FTC uses information from both an outdoor temperature sensor and a temperature sensor on the primary circuit supply to ensure the heat pump is not producing excessive flow temperatures if the weather conditions do not require it.

Your installer will set the parameters of the graph depending on local conditions and type of space heating used in your home. It should not be necessary for you to alter these settings. If however you find that over a reasonable operating period the space heating is not heating or is overheating your home, please contact your installer so they can check your system for any problems and update these settings if necessary.

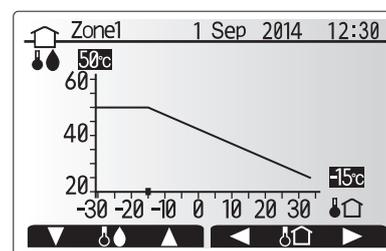
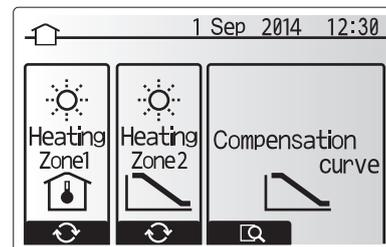

🏠 : Flow temp.
🏠 : Outdoor ambient temp.

Holiday Mode

Holiday mode can be used to keep the system running at lower flow temperatures and thus reduced power usage whilst the property is unoccupied. Holiday mode can run either flow temp., room temp., heating, compensation curve heating and DHW all at reduced flow temperatures to save energy if the occupier is absent.

From the main menu screen press button E should be pressed. Be careful not to hold down button E for too long as this will turn off the controller and system.

Once the holiday mode activation screen is displayed you can activate/deactivate and select the duration that you would like holiday mode to run for.

- Press button F1 to activate or deactivate holiday mode
- Use buttons F2, F3 and F4 to input the date which you would like holiday mode to activate or deactivate holiday mode for space heating.

<Editing holiday mode>

Refer to the menu tree in "7.2 Main remote controller" of Installation Manual. Should you require the Holiday mode settings e.g. the flow temp., room temp. to be altered you should contact your installer.

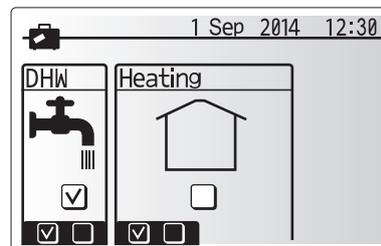
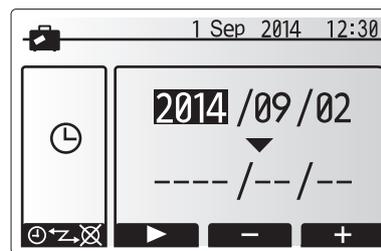

Schedule timer

Scheduled timer can be set in two ways, for example; one for summer and the other for winter. (Refer to as "Schedule 1" and "Schedule 2" respectively.) Once the term (months) for the Schedule 2 is specified, rest of the term will be specified as Schedule 2. In each Schedule, an operational pattern of modes (Heating / DHW) can be set. If no operational pattern is set for Schedule2, only the pattern for Schedule 1 will be valid. If Schedule 2 is set to full-year (i.e. March to Feb.), only the operational pattern for Schedule 2 will be valid.

The schedule timer is activated or deactivated in the option screen. (See 'General Operation' section)

<Setting the Schedule period>

1. From the main settings menu use F2 and F3 to highlight the schedule icon then press CONFIRM.
2. The Schedule period preview screen is displayed.
3. To change the Schedule period, press F4. button.
4. The time bar edit screen is displayed.
5. Use F2/F3 button to point at a starting month of the Schedule2, then press CONFIRM.
6. Use F2/F3 button to point at an ending month of the Schedule2, then press CONFIRM.
7. Press F4 to save settings.

<Setting the Schedule timer>

1. From the main settings menu use F2 and F3 to highlight the schedule icon then press CONFIRM.
2. From the schedule 2 period preview screen use F1 and F2 to scroll through the selecting each subtitle in turn by pressing CONFIRM.
3. The schedule timer sub menu will be displayed. The icons show the following modes;
 - Heating
 - Cooling
 - DHW
4. Use F2 and F3 buttons to move between mode icons press CONFIRM to be shown the PREVIEW screen for each mode.

The preview screen allows you to view the current settings. In 2-zone heating operation, press F1 to switch between Zone1 and Zone2. Days of the week are displayed across the top of the screen. Where day appears underlined the settings are the same for all those days underlined.

Hours of the day and night are represented as a bar across the main part of the screen. Where the bar is solid black, space heating/cooling and DHW (whichever is selected) is allowed.

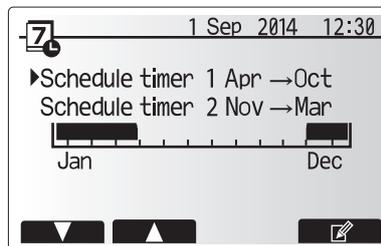

Schedule2 period preview screen

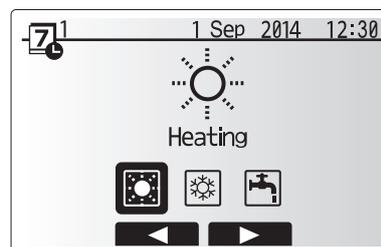

Schedule1 mode select screen

5. In the preview menu screen press F4 button.

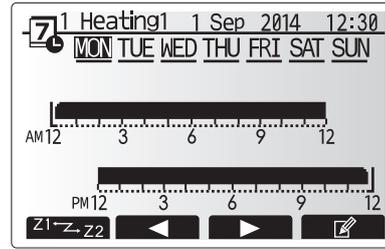

Preview screen

6. First select the days of the week you wish to schedule.
7. Press F2/F3 buttons to move between days and F1 to check or uncheck the box.
8. When you have selected the days press CONFIRM.

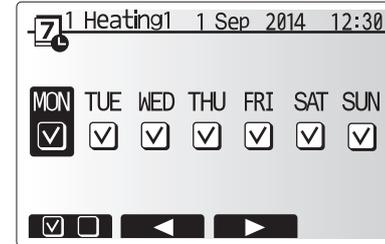

Day of week select screen

9. The time bar edit screen will be displayed.
10. Use buttons F2/F3 to move to the point at which you do not want the selected mode to be active press CONFIRM to start.
11. Use F3 button to set the required time of inactivity then press CONFIRM.
12. You can add up to 4 periods of inactivity within a 24 hours interval.

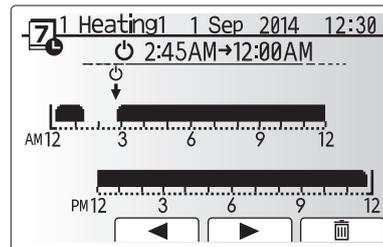

Time of period setting screen 1

13. Press F4 to save settings.

When scheduling heating, button F1 changes the scheduled variable between time and temperature. This enables a lower temperature to be set for a number of hours e.g. a lower temperature may be required at night when the occupants are sleeping.

Note:

- The schedule timer for space heating/cooling and DHW are set in the same way. However for DHW only time can be used as scheduling variable.
- A small rubbish bin character is also displayed choosing this icon will delete the last unsaved action.
- It is necessary to use the SAVE function F4 button to save settings. CONFIRM does NOT act as SAVE for this menu.

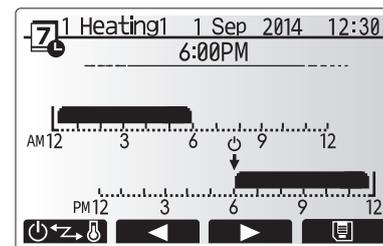

Time of period setting screen 2

Service Menu

The service menu provides functions for use by installer or service engineer. It is NOT intended the home owner alters settings within this menu. It is for this reason password protection is required to prevent unauthorised access to the service settings.

The factory default password is "0000".

Follow the procedure described in General Operation for the set up operation.

The service menu is navigated using the F1 and F2 buttons to scroll through the functions. The menu is split across two screens and is comprised of the following functions;

1. Manual operation
2. Function settings
3. Thermistor adjustment
4. Auxiliary settings
5. Heat source setting
6. Pump speed
7. Operation settings
8. Energy monitor settings
9. External input settings
10. Running information
11. Thermistor reading
12. Summary of settings
13. Error history
14. Password protection
15. Manual reset
16. SD card

In this Installation Manual, instructions will be given only for the following functions;

1. Manual operation
2. Auxiliary settings
3. Heat source setting
4. Operation settings
5. Energy monitor settings
6. External input settings
7. Password protection
8. Manual reset
9. SD card

Information on the other functions can be found by consulting the service manual.

Many functions can not be set whilst the indoor unit is running. The installer should turn off the unit before trying to set these functions. If the installer attempts to change the settings whilst the unit is running the main remote controller will display a reminder message prompting the installer to stop operation before continuing. By selecting "Yes" the unit will cease operation.

<Manual operation>

During the filling of the system the water circulation pump and 3-way valve can be manually overridden using manual operation mode.

When manual operation is selected a small timer icon appears in the screen. The function selected will only remain in manual operation for a maximum of 2 hours. This is to prevent accidental permanent override of the FTC.

► Example

Pressing F3 button will switch manual operation mode ON for the main 3-way valve. When filling of the DHW tank is complete the installer should access this menu again and press F3 to deactivate manual operation of the part. Alternatively after 2 hours manual operation mode will no longer be active and FTC will resume control of the part.

Manual operation and heat source setting can not be selected if the system is running. A screen will be displayed asking the installer to stop the system before these modes can be activated. The system automatically stops 2 hours after last operation.

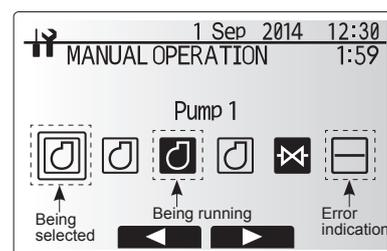

Manual operation menu screen

<Auxiliary settings>

This function is used to set the parameters for any auxiliary parts used in the system.

Menu subtitle	Function/ Description
Economy settings for pump	Water pump stops automatically in certain period of time from when operation is finished.
Delay	Time before pump switched off *1
Electric heater (Heating)	To select "WITH booster heater (ON)" or "WITHOUT booster heater (OFF)" in Heating mode.
Delay	The minimum time required for the booster heater to turn ON from after Heating mode has started.
Electric heater (DHW)	To select "WITH (ON)" or "WITHOUT (OFF)" booster heater or immersion heater individually in DHW mode.
Delay	The minimum time required for the booster heater or immersion heater to turn ON from after DHW mode has started. (This setting is applied for both booster and immersion heater.)
Mixing valve control *2	Period from valve fully open (at a hot water mixing ratio of 100%) to valve fully closed. (at a cold water mixing ratio of 100%)
Interval	Interval (min) to control the Mixing valve.
Flow sensor	Minimum The minimum flow rate to be detected at Flow sensor.
Maximum	The maximum flow rate to be detected at Flow sensor.

*1. Decreasing "time before pump switched off" may increase the duration of stand-by in Heating/Cooling mode.

*2. Set the Running time according to the specifications of the actuator of each mixing valve. It is recommended to set the interval to 2 minutes that is a default value. With the interval set longer, it could take longer to warm up a room.

<Heat source setting>

The default heat source setting is heat pump and all electric heaters present in the system to be operational. This is referred to as Standard operation on the menu.

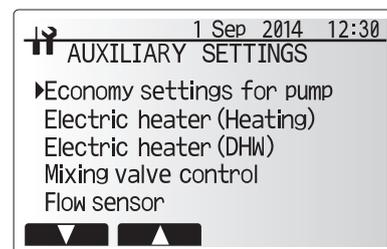

Auxiliary settings menu screen

<Operation settings>

Heating operation

This function allows operational setting of flow temperature range from the Ecodan and also the time interval at which the FTC collects and processes data for the auto adaptation mode.

Menu subtitle	Function	Range	Unit	Default	
Flow temp. range	Minimum temp.	To minimize the loss by frequent ON and OFF in mild outdoor ambient temperature seasons.	25 - 45	°C	30
	Maximum temp.	To set max. possible flow temperature according to the type of heat emitters.	35 - 60	°C	50
Room temp. control	Mode	Setting for Room temp. control At fast mode, target outlet water temperature is set higher than the one set at normal mode. This reduces the time to reach the target room temperature when the room temperature is relatively low.*	Normal/ Fast	—	Normal
	Interval	Selectable according to the heat emitter type and the materials of floor (i.e. radiators, floor heating-thick, -thin concrete, wood, etc.)	10 - 60	min	10
Heat pump thermo diff.adjust	On/Off	To minimize the loss by frequent ON and OFF in mild outdoor ambient temperature seasons.	On/Off	—	On
	Lower limit	Prohibits heat pump operation until the flow temperature drops below the target flow temperature plus lower limit value.	-9 - -1	°C	-5
	Upper limit	Allows heat pump operation until the flow temperature rises above the target flow temperature plus upper limit value.	+3 - +5	°C	+5

<Table 7.2.1> Heating operation (Room temp. control table)

Note:

1. The minimum flow temperature that prohibits heat pump operation is 20°C.
2. The maximum flow temperature that allows heat pump operation equals to the maximum temperature set in the Flow temp. range menu.

* Fast mode is not efficient and will increase running cost when compared to normal mode.

Freeze stat function

Menu subtitle	Function/ Description
Freeze stat function *1	An operational function to prevent the water circuit from freezing when outdoor ambient temperature drops.
Flow t.	The target outlet water temperature at water circuit when operating in Freeze stat function. *2
	Outdoor ambient temp.

*1. When the system is turned off, freeze stat function is not enabled.

*2. Flow t. is fixed to 20°C and unchangeable.

Simultaneous Operation

For periods of very low outside temperature this mode can be used. Simultaneous operation allows both DHW and space heating to run together by using the heat pump and/or booster heater to provide space heating whilst only the immersion heater provides heating for DHW. This operation is only available if BOTH a DHW tank AND immersion heater are present on the system.

- Range of outdoor ambient temperature at which simultaneous operation starts is -30°C to 10°C (default -15°C).
- System shall automatically return to routine operation. This will happen when the outdoor ambient temperature rises above the selected temperature for this specific mode of operation.

<Cold weather function>

For extremely low outdoor ambient temperature conditions when the heat pump's capacity is restricted the heating or DHW is provided only by the electric booster heater (and immersion if present). This function is intended for use during extreme cold periods only. Extensive use of direct electrical heaters ONLY will result in higher power consumption and may reduce working life of heaters and related parts.

- Range of outdoor ambient temperature at which cold weather function starts is -30°C to -10°C (default -15°C).
- System shall automatically return to routine operation. This will happen when the outdoor ambient temperature rises above the selected temp. for this specific mode of operation.

Floor dry up function

The Floor dry up function automatically changes the target hot water temperature in stages to gradually dry concrete when this particular type of underfloor heating system is installed.

Upon completion of the operation the system stops all the operations except the Freeze stat. operation.

For Floor dry up function, the target flow temp. of Zone1 is the same as that of Zone2.

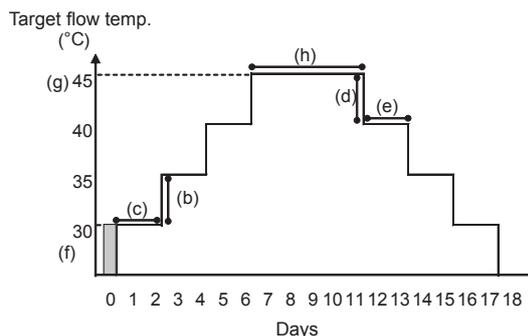

- This function is not available when a PUAZ-FRP outdoor unit is connected.
- Disconnect wiring to external inputs of room thermostat, demand control, and outdoor thermostat, or the target flow temperature may not be maintained.

Functions	Symbol	Description	Option/Range	Unit	Default	
Floor dry up function	a	Set the function to ON and power on the system using the main remote controller, and the dry up heating operation will start.	On/Off	—	Off	
Flow temp. (increase)	Flow temp. increase step	b	Sets the increase step of the target flow temperature.	+1 - +10	°C	+5
	Increase interval	c	Sets the period for which the same target flow temperature is maintained.	1 - 7	day	2
Flow temp. (decrease)	Flow temp. decrease step	d	Sets the decrease step of the target flow temperature.	-1 - -10	°C	-5
	Decrease interval	e	Sets the period for which the same target flow temperature is maintained.	1 - 7	day	2
Target temperature	Start & Finish	f	Sets the target flow temperature at the start and the finish of the operation.	25 - 60	°C	30
	Max. target temp.	g	Sets the maximum target flow temperature.	25 - 60	°C	45
	Max. temp. period	h	Sets the period for which the maximum target flow temperature is maintained.	1 - 20	day	5

<Energy monitor settings>

In this menu, all parameters required to record the consumed electric energy and the delivered heat energy which is displayed on the main remote controller can be set. The parameters are an electric heater capacity, supply power of water pump and heat meter pulse.

Follow the procedure described in General Operation for the set up operation.

Refer to the section [Energy Monitor] in "3. system"

<External input settings>

Demand control(IN4)

The selection of "OFF", whilst a signal is being sent to IN4, forcefully stops all the heat source operations and the selection of "Boiler" stops operations of heat pump and electric heater and performs boiler operation.

Outdoor thermostat (IN5)

The selection of "Heater", whilst a signal is being sent to IN5, performs electric-heater-only operation and the selection of "Boiler" performs boiler operation.

<Password protection>

Password protection is available to prevent unauthorised access to the service menu by untrained persons.

Resetting the password

If you forget the password you entered, or have to service a unit somebody else installed, you can reset the password to the factory default of **0000**.

1. From the main settings menu scroll down the functions until Service Menu is highlighted.
2. Press CONFIRM.
3. You will be prompted to enter a password.
4. Hold down buttons F3 and F4 together for 3 seconds
5. You will be asked if you wish to continue and reset the password to default setting.
6. To reset press button F3.
7. The password is now reset to **0000**.

<Manual reset>

Should you wish to restore the factory settings at any time you should use the manual reset function. Please note this will reset ALL functions to the factory default settings.

<SD card>

The use of an SD memory card simplifies the main remote controller settings in the field.

Notes:

1. Ecodan service tool (for use with PC tool) is necessary for the setting.
2. The SD card setting for multiple outdoor units control should be done after turning the power supply of all FTC units (Master/ Slave) ON.
3. If "COMPLETE!" does not appear, it means the operation is not properly completed. Reset the whole system before re-try.



Password input screen



Password verify screen

Engineers Forms

Should settings be changed from default, please enter and record new setting in 'Field Setting' column. This will ease resetting in the future should the system use change or the circuit board need to be replaced.

Commissioning/Field settings record sheet

Main remote controller screen		Parameters	Default setting	Field setting	Notes	
Main	Zone1 heating room temp.		10°C - 30°C	20°C		
	Zone2 heating room temp. *1		10°C - 30°C	20°C		
	Zone1 heating flow temp.		25°C - 60°C	45°C		
	Zone2 heating flow temp. *1		25°C - 60°C	35°C		
	Zone1 cooling flow temp.		5°C - 25°C	15°C		
	Zone2 cooling flow temp.		5°C - 25°C	20°C		
	Zone1 heating compensation curve		-9°C - + 9°C	0°C		
	Zone2 heating compensation curve *1		-9°C - + 9°C	0°C		
	Holiday mode		Active/Non active/Set time	—		
Option	Forced DHW operation		On/Off	—		
	DHW		On/Off/Timer	On		
	Heating/Cooling		On/Off/Timer	On		
	Energy monitor		Consumed electric energy/Delivered energy	—		
Setting	DHW *13	Operation mode		Normal/Eco	Normal	
		DHW max. temp.		40°C - 60°C *2	50°C	
		DHW temp. drop		5°C - 30°C	10°C	
		DHW max. operation time		30 - 120 min	60 min	
		DHW mode restriction		30 - 120 min	30 min	
		Legionella prevention *13		Active	Yes/No	Yes
			Hot water temp.	60°C - 70°C *2	65°C	
			Frequency	1 - 30 days	15 days	
			Start time	00.00 - 23.00	03.00	
			Max. operation time	1 - 5 hours	3 hours	
			Duration of maximum temp.	1 - 120 min	30 min	
	Heating/ Cooling *12		Zone1 operation mode	Heating room temp./ Heating flow temp./ Heating compensation curve/ Cooling flow temp.	Room temp.	
			Zone2 operation mode *1	Heating room temp./ Heating flow temp./ Heating compensation curve/ Cooling flow temp.	Compensation curve	
	Compensation curve	Hi flow temp. set point	Zone1 outdoor ambient temp.		-30°C - +33°C *3	-15°C
			Zone1 flow temp.		25°C - 60°C	50°C
			Zone2 outdoor ambient temp. *1		-30°C - +33°C *3	-15°C
			Zone2 flow temp. *1		25°C - 60°C	40°C
		Lo flow temp. set point	Zone1 outdoor ambient temp.		-28°C - +35°C *4	35°C
			Zone1 flow temp.		25°C - 60°C	25°C
			Zone2 outdoor ambient temp. *1		-28°C - +35°C *4	35°C
Zone2 flow temp.			25°C - 60°C	25°C		
Adjust		Zone1 outdoor ambient temp.		-29°C - +34°C *5	—	
		Zone1 flow temp.		25°C - 60°C	—	
		Zone2 outdoor ambient temp. *1		-29°C - +34°C *5	—	
		Zone2 flow temp. *1		25°C - 60°C	—	
Holiday	DHW *13		Active/Non active	Non active		
	Heating/ Cooling		Active/Non active	Active		
	Zone1 heating room temp.		10°C - 30°C	15°C		
	Zone2 heating room temp. *1		10°C - 30°C	15°C		
	Zone1 heating flow temp.		25°C - 60°C	35°C		
	Zone2 heating flow temp. *1		25°C - 60°C	25°C		
	Zone1 cooling flow temp.		5°C - 25°C	25°C		
	Zone2 cooling flow temp.		5°C - 25°C	25°C		
Initial settings	Language		EN/FR/DE/SV/ES/IT/DA/NL/FI/NO/PT/BG/PL/CZ/RU	EN		
	°C/°F		°C/°F	°C		
	Summer time		On/Off	Off		
	Temp. display		Room/DHW tank/Room&DHW tank /Off	Off		
	Time display		hh:mm/hh:mm AM/AM hh:mm	hh:mm		
	Room sensor settings for Zone1		TH1/Main RC/Room RC1-8/Time/Zone"	TH1		
	Room sensor settings for Zone2 *1		TH1/Main RC/Room RC1-8/Time/Zone"	TH1		
	Room RC zone select *1		Zone1/Zone2	Zone1		
Service menu	Thermistor adjustment	THW1	-10°C - +10°C	0°C		
		THW2	-10°C - +10°C	0°C		
		THW5	-10°C - +10°C	0°C		
		THW6	-10°C - +10°C	0°C		
		THW7	-10°C - +10°C	0°C		
		THW8	-10°C - +10°C	0°C		
		THW9	-10°C - +10°C	0°C		
		THWB1	-10°C - +10°C	0°C		
		THWB2	-10°C - +10°C	0°C		
		Auxiliary settings	Economy settings for pump.		On/Off *6	On
	Delay			10 min		
	Electric heater (Heating)		Space heating: On (used)/Off (not used)	On		
	Electric heater delay timer (5 - 180 min)			30 min		
	Booster heater DHW: On (used)/Off (not used)			On		
	Immersion heater DHW: On (used)/Off (not used)			On		
	Electric heater delay timer (15 - 30 min)			15 min		
	Mixing valve control		Running (10 - 240 sec)	120 sec		
	Interval (1 - 30 min)			2 min		
	Flow sensor		Minimum (0 - 100L/min)	5 L/min		
			Maximum (0 - 100L/min)	100 L/min		

*1 The settings related to Zone2 can be switched only when 2 Zone temperature control is enabled (when DIP SW2-6 and SW 2-7 are ON).

*2 For the model without both booster and immersion heater, it may not reach the set temperature depending on the outside ambient temperature.

*3 The lower limit is -15°C depending on the connected outdoor unit.

*4 The lower limit is -13°C depending on the connected outdoor unit.

*5 The lower limit is -14°C depending on the connected outdoor unit.

(Continued to next page.)

Engineers Forms

Commissioning/Field settings record sheet (continued from the previous page)

Main remote controller screen			Parameters	Default setting	Field setting	Notes		
Service menu	Pump speed	Pump speed		Pump speed (1 - 5)	5			
		Heat source setting		Standard/Heater/Boiler/Hybrid *7	Standard			
		Operation settings	Heating operation *8	Flow temp.range *10	Min.temp. (25 - 45°C)	30°C		
					Max.temp. (35 - 60°C)	50°C		
				Room temp.control *13	Mode (Normal/Fast)	Normal		
					Interval (10 - 60min)	10min		
				Heat pump thermo diff.adjust	On/Off *6	On		
					Lower limit (-9 - -1°C)	-5°C		
					Upper limit (+3 - +5°C)	5°C		
				Freeze stat function *11		Outdoor ambient temp. (3 - 20°C) / **	5°C	
				Simultaneous operation (DHW/Heating)		On/Off *6	Off	
						Outdoor ambient temp. (-30 - +10°C) *4	-15°C	
		Cold weather function		On/Off *6	Off			
				Outdoor ambient temp. (-30 - -10°C) *4	-15°C			
		Boiler operation		Hybrid settings	Outdoor ambient temp. (-30 - +10°C) *4	-15°C		
				Priority mode (Ambient/Cost/CO2)	Ambient			
				Intelligent settings	Energy price *9	Electricity (0.001 - 999 */kWh)	0.5 */kWh	
					Boiler (0.001 - 999 */kWh)	0.5 */kWh		
				CO2 emission	Electricity (0.001 - 999 kg -CO2/kWh)	0.5 kg -CO2/kWh		
					Boiler (0.001 - 999 kg -CO2/kWh)	0.5 kg -CO2/kWh		
				Heat source	Heat pump capacity (1 - 40 kW)	11.2 kW		
					Boiler efficiency (25 - 150%)	80%		
					Booster heater 1 capacity (0 - 30 kW)	2 kW		
					Booster heater 2 capacity (0 - 30 kW)	4 kW		
		Floor dry up function		On/Off *6	Off			
				Target temp.	Start&Finish (25 - 60°C)	30°C		
					Max. temp. (25 - 60°C)	45°C		
					Max. temp. period (1 - 20 days)	5 days		
				Flow temp. (Increase)	Temp. increase step (+1 - +10°C)	+5°C		
					Increase interval (1 - 7 days)	2 days		
		Flow temp. (Decrease)	Temp. decrease step (-1 - -10°C)	-5°C				
			Decrease interval (1 - 7 days)	2 days				
Energy monitor settings	Electric heater capacity	Booster heater 1 capacity	0 - 30kW	2kW				
		Booster heater 2 capacity	0 - 30kW	4kW				
		Immersion heater capacity	0 - 30kW	0kW				
	Delivered energy adjustment		-50 - +50%	0%				
	Water pump input	Pump 1	0 - 200W or ***(factory fitted pump)	***				
		Pump 2	0 - 200W	0W				
		Pump 3	0 - 200W	0W				
	Electric energy meter		0.1/1/10/100/1000 pulse/kWh	1 pulse/kWh				
	Heat meter		0.1/1/10/100/1000 pulse/kWh	1 pulse/kWh				
	External input settings	Demand control (IN4)		Heat source OFF/Boiler operation	Boiler operation			
Outdoor thermostat (IN5)		Heater operation/Boiler operation	Boiler operation					

Flow temp.controller

*6 On: the function is active; Off: the function is inactive.

*7 When DIP SW1-1 is set to OFF "WITHOUT Boiler" or SW2-6 is set to OFF "WITHOUT Mixing tank", neither Boiler nor Hybrid can be selected.

*8 Valid only when operating in Room temp. control mode.

9 "" of "*/kWh" represents currency unit (e.g. € or £ or the like)

*10 Valid only when operating in Heating room temperature.

*11 If asterisk (**) is chosen freeze stat function is deactivated. (i.e. primary water freeze risk)

*12 Only available if DHW tank present in system.

*13 When DIP SW5-2 is set to OFF, this function is active.

<Troubleshooting by inferior phenomena>

No.	Fault symptom	Possible cause	Explanation - Solution
1	Main remote controller display is blank.	<ol style="list-style-type: none"> There is no power supply to main remote controller. Power is supplied to main remote controller, however, the display on the main remote controller does not appear. 	<ol style="list-style-type: none"> Check LED2 on FTC (Master). (See <Figure 4.5.1>.) <ol style="list-style-type: none"> When LED2 is lit. <ul style="list-style-type: none"> Check for damage or contact failure of the main remote controller wiring. When LED2 is blinking. <ul style="list-style-type: none"> Refer to No. 5 below. When LED2 is not lit. <ul style="list-style-type: none"> Refer to No. 4 below. Check the following: <ul style="list-style-type: none"> Disconnection between the main remote controller cable and the FTC (Master) control board Failure of the main remote controller if "Please Wait" is not displayed. Refer to No. 2 below if "Please Wait" is displayed.
2	"Please Wait" remains displayed on the main remote controller.	<ol style="list-style-type: none"> "Please Wait" is displayed for up to 6 minutes. Communication failure between the main remote controller and FTC (Master). Communication failure between FTC (Master) and outdoor unit. 	<ol style="list-style-type: none"> Normal operation. Main remote controller start up checks/procedure. <ol style="list-style-type: none"> If "0%" or "50-99%" is displayed below "Please Wait" there is a communication error between the main remote controller and the FTC (Master) control board. <ul style="list-style-type: none"> Check wiring connections on the main remote controller. Replace the main remote controller or the FTC (Master) control board. If "1-49%" is displayed there is a communication error between the outdoor unit's and FTC (Master) control boards. <ul style="list-style-type: none"> Check the wiring connections on the outdoor unit control board and the FTC (Master) control board. (Ensure S1 and S2 are not cross-wired and S3 is securely wired with no damage. (See section 4.1.) Replace the outdoor unit's and/or the FTC (Master) control boards.
3	The main screen appears with a press of the "ON" button, but disappears in a second.	The main remote controller operations do not work for a whilst after the settings are changed in the service menu. This is because the system takes time to apply the changes.	<p>Normal operation.</p> <p>The indoor unit is applying updated settings made in the service menu. Normal operation will start shortly.</p>
4	LED2 on FTC (Master) is off. (See <Figure 4.5.1>.)	<p>When LED1 on FTC (Master) is also off. (See <Figure 4.5.1>.)</p> <p><FTC (Master) powered via outdoor unit.></p> <ol style="list-style-type: none"> The outdoor unit is not supplied at the rated voltage. Defective outdoor controller circuit board FTC (Master) is not supplied with 220 to 240V AC FTC (Master) failure Faulty connector wiring 	<ol style="list-style-type: none"> Check the voltage across the terminals L and N or L3 and N on the outdoor power board. (See section 4.1.) <ul style="list-style-type: none"> When the voltage is not 220 to 240V AC, check wiring of the outdoor unit and of the breaker. When the voltage is at 220 to 240V AC, go to "2." below. Check the voltage across the outdoor unit terminals S1 and S2. (See section 4.1.) <ul style="list-style-type: none"> When the voltage is not 220 to 240V AC, check the fuse on the outdoor control board and check for faulty wiring. When the voltage is 220 to 240V AC, go to "3." below. Check the voltage across the indoor unit terminals S1 and S2. (See section 4.1.) <ul style="list-style-type: none"> When the voltage is not 220 to 240V AC, check FTC (Master)-outdoor unit wiring for faults. When the voltage is 220 to 240V AC, go to "4." below. Check the FTC (Master) control board. <ul style="list-style-type: none"> Check the fuse on FTC (Master) control board. Check for faulty wiring. If no problem found with the wiring, the FTC (Master) control board is faulty. Check the connector wiring. <ul style="list-style-type: none"> When the connectors are wired incorrectly, re-wire the connectors referring to below. (See section 4.1.)

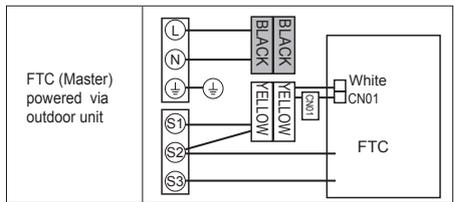

Flow temp.controller

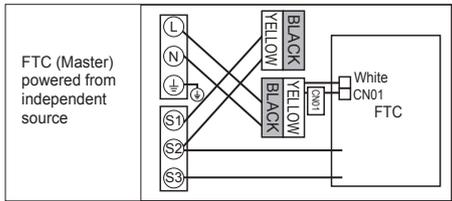
No.	Fault symptom	Possible cause	Explanation - Solution
4.	LED2 on FTC (Master) is off. (See Figure <4.5.1>)	<FTC (Master) powered on independent source>	<ol style="list-style-type: none"> Check the voltage across the L and N terminals on the indoor power supply terminal block. (See section 4.1.) <ul style="list-style-type: none"> When the voltage is not 220 to 240V AC, check for faulty wiring to power supply. When the voltage is 220 to 240V AC, go to 2. below. Check for faulty wiring between the connectors. <ul style="list-style-type: none"> When the connectors are wired incorrectly re-wire them correctly referring to below. (See section 4.1 and a wiring diagram on the control and electrical box cover.)  <ul style="list-style-type: none"> If no problem found with the wiring, go to 3. below.
		<ol style="list-style-type: none"> FTC (Master) is not supplied with 220 to 240V AC. There are problems in the method of connecting the connectors. FTC (Master) failure 	
		When LED1 on FTC (Master) is lit. Incorrect setting of refrigerant address for outdoor unit. (None of the refrigerant address is set to "0".)	Recheck the refrigerant address setting on the outdoor unit. Set the refrigerant address to "0". (Set refrigerant address using SW1(3 - 6) on outdoor controller circuit board.)
5	LED2 on FTC (Master) is blinking. (See Figure <4.5.1>)	When LED1 is also blinking on FTC (Master). Faulty wiring between FTC (Master) and outdoor unit	Check for faulty wiring between FTC (Master) and outdoor unit.
		When LED1 on FTC (Master) is lit. <ol style="list-style-type: none"> Faulty wiring in main remote controller Multiple indoor units have been wired to a single outdoor unit. Short-circuited wiring in main remote controller Main remote controller failure 	<ol style="list-style-type: none"> Check for faulty wiring in main remote controller. The number of indoor units that can be wired to a single outdoor unit is one. Additional indoor units must be wired individually to a single outdoor unit. Remove main remote controller wires and check LED2 on FTC (Master). (See Figure 4.5.1.) <ul style="list-style-type: none"> If LED2 is blinking check for short circuits in the main remote controller wiring. If LED2 is lit, wire the main remote controller again and: <ul style="list-style-type: none"> if LED2 is blinking, the main remote controller is faulty; if LED2 is lit, faulty wiring of the main remote controller has been corrected.
6	LED4 on FTC (Master) is off. (See figure <4.5.1>)	<ol style="list-style-type: none"> SD memory card is NOT inserted into the memory card slot with correct orientation. Not an SD standards compliant memory card. 	<ol style="list-style-type: none"> Correctly insert SD memory card in place until a click is heard. Use an SD standards compliant memory card. (Refer to section 4.11.)
	LED4 on FTC (Master) is blinking. (See Figure <4.5.1>)	<ol style="list-style-type: none"> Full of data. Write-protected. NOT formatted. Formatted in NTFS file system. 	<ol style="list-style-type: none"> Move or delete data, or replace SD memory card with a new one. Release the write-protect switch. Refer to "4.11 Using SD memory card". FTC is Not compatible with NTFS file system. Use an SD memory card formatted in FAT file system.
7	No water at hot tap.	<ol style="list-style-type: none"> Cold main off Strainer (local supply) blocked. 	<ol style="list-style-type: none"> Check and open stop cock. Isolate water supply and clean strainer.
8	Cold water at tap.	<ol style="list-style-type: none"> Hot water run out. Prohibit, schedule timer or holiday mode selected. Heat pump not working. Booster heater cut-out tripped. The earth leakage circuit breaker for booster heater breaker (ECB1) tripped. The booster heater thermal cut-out has tripped and cannot be reset using the manual reset button. Immersion heater cut-out tripped. Immersion heater breaker (ECB2) tripped. 3-way valve fault 	<ol style="list-style-type: none"> Ensure DHW mode is operating and wait for DHW tank to re-heat. Check settings and change as appropriate. Check heat pump – consult outdoor unit service manual. Check booster heater thermostat and press reset button if safe. Check the cause and reset if safe. Check resistance across the thermal cut-out, if open then the connection is broken and the booster heater will have to be replaced. Contact your Mitsubishi Electric dealer. Check immersion heater thermostat and press reset button, located on immersion heater boss, if safe. If the heater has been operated with no water inside it may have failed, so please replace it with a new one. Check the cause and reset if safe. Check plumbing/wiring to 3-way valve. <ol style="list-style-type: none"> Manually override 3-way valve using the main remote controller. (Refer to <Manual operation> in section 7.2.) If the valve does not still function, go to (ii) below. Replace 3-way valve coil. If the valve does not still function, go to (iii) below. Replace 3-way valve. (Refer to the service manual.)

No.	Fault symptom	Possible cause	Explanation - Solution
9	Water heating takes longer.	<ol style="list-style-type: none"> Heat pump not working. Booster heater cut-out tripped. Booster heater breaker tripped. The booster heater thermal cut-out has tripped and cannot be reset using the manual reset button. Immersion heater cut-out has been triggered. Immersion heater breaker tripped. Decreased flow rate in DHW circuit. (Only when the external plate HEX for DHW is used.) 	<ol style="list-style-type: none"> Check heat pump – consult outdoor unit service manual. Check booster heater thermostat and press reset button if safe. Check the cause and reset if safe. Check resistance across the thermal cut-out, if open then connection is broken and the booster heater will have to be replaced. Contact your Mitsubishi Electric dealer. Check immersion heater thermostat and press reset button located on immersion heater boss, if safe. If the heater kept running with no water inside, this may have resulted in failure, so replace it with a new one. Check the cause and reset if safe. Check the water circulation pump 4 (DHW).
10	Temperature of DHW tank water dropped.	<p>When DHW operation is not running, the DHW tank emits heat and the water temperature decreases to a certain level. If water in the DHW tank is reheated frequently because of a significant drop in water temperature, check for the following.</p> <ol style="list-style-type: none"> Water leakage in the pipes that connect to the DHW tank Insulation material coming loose or off. 3-way valve failure 	<ol style="list-style-type: none"> Take the following measures. <ul style="list-style-type: none"> Retighten the nuts holding the pipes onto the DHW tank. Replace seal materials. Replace the pipes. Fix insulation. Check plumbing/wiring to 3-way valve. <ol style="list-style-type: none"> Manually override 3-way valve using the main remote controller. (Refer to <Manual operation> in section 7.2.) If the valve does not still function, go to (ii) below. Replace 3-way valve coil. If the valve does not still function, go to (iii) below. Replace 3-way valve. (Refer to the service manual.)
11	Hot or warm water from cold tap.	Heat of hot water pipe is transferred to cold water pipe.	Insulate/re-route pipework.
12	Water leakage	<ol style="list-style-type: none"> Poorly sealed connections of water circuit components Water circuit components reaching the end of life 	<ol style="list-style-type: none"> Tighten connections as required. Refer to PARTS CATALOG in the service manual for expected part lifetimes and replace them as necessary.
13	Heating system does not reach the set temperature.	<ol style="list-style-type: none"> Prohibit, schedule timer or holiday mode selected. Check settings and change as appropriate. The temperature sensor is located in a room that has a different temperature relative to that of the rest of the house. Heat pump not working. Booster heater cut-out tripped. Booster heater breaker (ECB1) tripped. The booster heater thermal cut-out tripped and can not be reset using the manual reset button. Incorrectly sized heat emitter. 3-way valve failure Battery problem (*wireless control only) If a mixing tank is installed, the flow rate between the mixing tank and the heat exchanger is less than that between the mixing tank and the local system. 	<ol style="list-style-type: none"> Check settings and change as appropriate. Check the battery power and replace if flat. Relocate the temperature sensor to a more suitable room. Check heat pump – consult outdoor unit service manual. Check booster heater thermostat and press reset button if safe. Check the cause of the trip and reset if safe. Check resistance across the thermal cut-out, if open then the connection is broken and the booster heater will have to be replaced. Contact your Mitsubishi Electric dealer. Check the heat emitter surface area is adequate. Increase size if necessary. Check plumbing/wiring to 3-way valve. Check the battery power and replace it flat. Increase the flow rate between the mixing tank and the heat exchanger decrease that between the mixing tank and the local system.

No.	Fault symptom	Possible cause	Explanation - Solution
14	In 2-zone temperature control, only Zone2 does not reach the set temperature.	<ol style="list-style-type: none"> When Zone1 and Zone2 are both in heating mode, the hot water temperature in Zone2 does not exceed that in Zone1. Faulty wiring of motorized mixing valve Faulty installation of motorized mixing valve Incorrect setting of Running time Motorized mixing valve failure 	<ol style="list-style-type: none"> Normal action no action necessary. Refer to "4.7 Wiring for 2-zone temperature control". Check for correct installation. (Refer to the manual included with each motorized mixing valve.) Check for correct setting of Running time. Inspect the mixing valve. (Refer to the manual included with each motorized mixing valve.)
15	After DHW operation room temperature rises slightly.	At the end of the DHW mode operation the 3-way valve diverts hot water away from the DHW circuit into space heating circuit. This is done to prevent the system components from overheating. The amount of hot water directed into the space heating circuit varies according to the type of the system.	Normal operation no action necessary.
16	The room temperature rises during DHW operation.	3-way valve failure	Check the 3-way valve.
17	Water discharges from pressure relief valve. (Primary circuit)	<ol style="list-style-type: none"> If continual – pressure relief valve may be damaged. If intermittent – expansion vessel charge may have reduced/bladder perished. 	<ol style="list-style-type: none"> Turn the handle on the pressure relief valve to check for foreign objects in it. If the problem is not still solved, replace the pressure relief valve with a new one. Check pressure in expansion vessel. Recharge to 1 bar if necessary. If bladder perished replace expansion vessel with a new one.
18	Water discharges from pressure relief valve (field supplied item). (Sanitary circuit)	<ol style="list-style-type: none"> If continual – field supplied pressure reducing valve not working. If continual – pressure relief valve seat may be damaged. If intermittent – expansion vessel charge may have reduced/bladder perished. DHW tank may have subjected to backflow. 	<ol style="list-style-type: none"> Check function of pressure reducing valve and replace if necessary. Turn the handle on the pressure relief valve to check for foreign objects inside. If the problem is not still solved, replace the pressure relief valve. Check gas-side pressure in expansion vessel. Recharge to correct precharge pressure if necessary. If bladder perished replace expansion vessel with a new one with appropriate pre-charge. Check gas-side pressure in DHW tank. If pressure in DHW tank is similar to that in incoming mains, cold water supply that merges with incoming mains water supply could flow back to DHW tank. Investigate source of back-feed and rectify error in pipework/fitting configuration. Adjust pressure in cold supply.
19	Noisy water circulation pump	Air in water circulation pump.	Use manual and automatic air vents to remove air from system. Top up water if necessary to achieve 1 bar on primary circuit.
20	Noise during hot water draw off typically worse in the morning.	<ol style="list-style-type: none"> Loose airing cupboard pipework. Heaters switching on/off. 	<ol style="list-style-type: none"> Install extra pipe fastening clips. Normal operation no action necessary.
21	Mechanical noise heard coming from the system.	<ol style="list-style-type: none"> Heaters switching on/off. 3-way valve changing position between DHW and heating mode. 	Normal operation no action necessary.
22	Water circulation pump runs for a short time unexpectedly .	Water circulation pump jam prevention mechanism (routine) to inhibit the build-up of scale.	Normal operation no action necessary.
23	Milky/Cloudy water (Sanitary circuit)	Oxygenated water	Water from any pressurised system will release oxygen bubbles when water is running. The bubbles will settle out.
24	Heating mode has been on standby for a long time (does not start operation smoothly.)	The time of "Delay" set in "Economy settings for pump" is too short. (Go to "Service menu" → "Auxiliary settings" → "Economy settings for pump")	Increase the time of "Delay" in "Economy settings for pump" .
25	The FTC unit that was running in the heating mode before power failure is running in the DHW mode after power recovery.	The FTC unit is designed to run in an operation mode with a higher priority (i.e. DHW mode in this case) at power recovery.	<ul style="list-style-type: none"> Normal operation. After the DHW max. operation time has elapsed or the DHW max. temperature has been reached, the DHW mode switches to the other mode (ex. Heating mode).
26	Cooling mode is NOT available.	Dip SW2-4 is OFF.	Turn Dip SW2-4 to ON. (Refer to "5.1 Dip Switch Functions" in this manual.)

No.	Fault symptom	Possible cause	Explanation - Solution
27	The cooling system does not cool down to the set temperature.	<ol style="list-style-type: none"> When the water in the circulation circuit is unduly hot, Cooling mode starts with a delay for the protection of the outdoor unit. When the outdoor temperature is lower than the preset temperature below which the freeze stat. function is activated, Cooling mode does not start running. 	<ol style="list-style-type: none"> Normal operation. To run Cooling mode overriding the freeze stat. function, adjust the preset temperature below which the freeze stat. function is activated. (Refer to "<Freeze stat function>" on Page C-46.)
28	The electric heaters are activated shortly after DHW or LP mode starts running after Cooling mode.	The setting time period of Heat-pump-only operation is short.	Adjust the setting time period of Heat-pump only operation. (Refer to "<Electric heater (DHW)>" on Page C-46.)
29	During DHW or LP mode following the cooling mode, error L6 (circulation water freeze protection) occurs and operation stops frequently.	If the preset temperature below which the freeze stat. function is activated is low, error L6 is more likely to occur interruption operation before the freeze stat. function is activated.	Adjust the preset temperature below which the freeze stat. function is activated. (Refer to "<Freeze stat function>" on Page C-46.)
30	Heat pump is forced to turn ON and OFF.	Smart grid ready input (IN11 and IN12) is used, and switch-on and off commands are input.	Normal operation no action necessary.

9.1 Wiring for multiple outdoor units control

To establish a larger system, up to 6 outdoor units of the same model can be connected in one system.

Note: PUHZ-FRP outdoor unit is not available for multiple outdoor units control.

9.1.1 Requirements

<Outdoor unit>

- (a) Up to 6 units can be connected.
- (b) All the outdoor units must be of the same model.
- (c) The outdoor units must be connected to slave units.

<FTC: Master unit>

Each slave unit is controlled by the master unit.

- (a) The outdoor units must NOT be connected to the master unit.
Make sure that the master unit is powered by independent source.
- (b) Wire the main remote controller to TBI.2 13-14 on the master unit.
- (c) Wire the electric heater to the master unit.

<FTC: Slave unit>

The hydrobox or PAC-SIF051B-E or master unit is used as a slave unit

- (a) Connect each outdoor unit to a slave unit.
- (b) The main remote controller must NOT be wired to a slave unit.

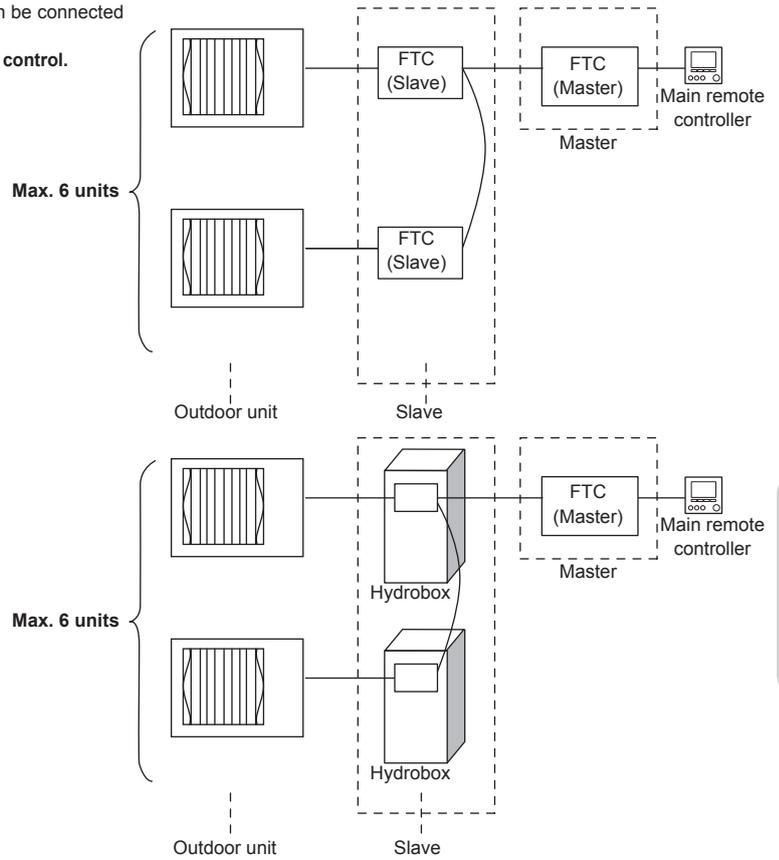

9.2 Pipe work

Following is the system example of two outdoor units being connected in one system.

IMPORTANT NOTE

Keep the minimum amount of water required in the space heating circuit according to the number of outdoor units.

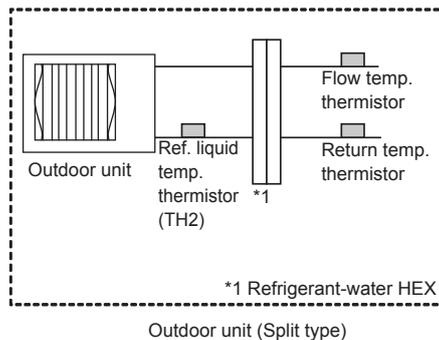
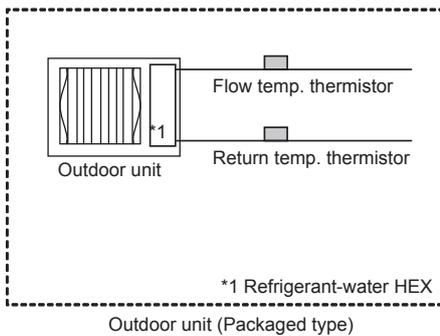

<Fig. 9.2.1>

System 1: Heating/Cooling system

- Install a low loss header (local supply).
- Install booster heater toward the local system, relative to the low loss header.

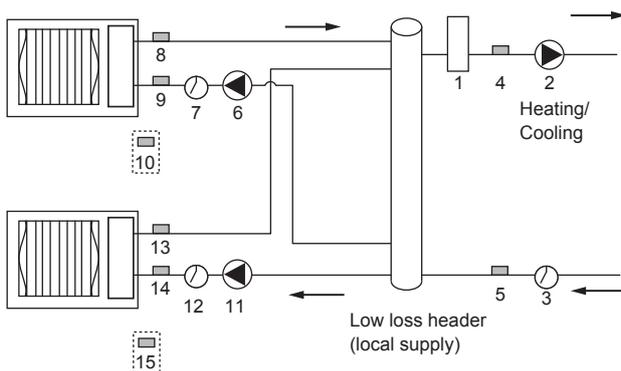

<Fig. 9.2.2>

No.	Component	Wiring		
		Master	Slave 1	Slave 2
1	Booster heater (local supply)	✓		
2	Circulation pump1 (local supply)	✓		
3	Flow switch1 (local supply) *2	✓		
4	Flow temp. thermistor (THW1)	✓		
5	Return temp. thermistor (THW2)	✓		
6	Slave1 circulation pump1 (local supply)		✓	
7	Slave1 flow switch (local supply) *2		✓	
8	Slave1 flow temp. thermistor (THW1)		✓	
9	Slave1 return temp. thermistor (THW2)		✓	
10	Slave1 ref. liquid temp. thermistor (TH2) *1		✓	
11	Slave2 circulation pump1 (local supply)			✓
12	Slave2 flow switch (local supply) *2			✓
13	Slave2 flow temp. thermistor (THW1)			✓
14	Slave2 return temp. thermistor (THW2)			✓
15	Slave2 ref. liquid temp. thermistor (TH2) *1			✓

*1 When the outdoor unit is split type, TH2 needs to be installed. <Fig. 9.2.1>

*2 For safety protection, it is recommended to install a flow switch.

System 2: Heating/Cooling & DHW system

- Install DHW tank toward the outdoor unit , relative to the low loss header.
- Wire 3-way valve 1, 2 to FTC (slave unit).
- LP mode uses assistance of electric heater. Place an immersion heater on the DHW circuit.
- Install a low loss header (local supply).
- Install booster heater toward the local system, relative to the low loss header.

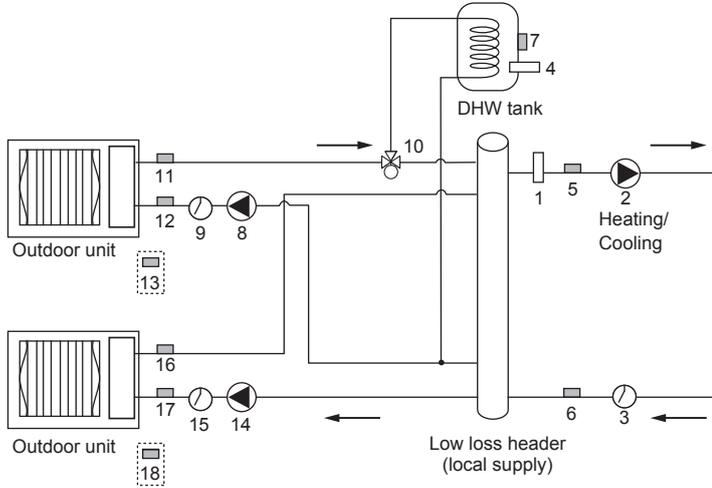

<Fig. 9.2.3>

No.	Component	Wiring		
		Master	Slave 1 *4	Slave 2
1	Booster heater (local supply)	✓		
2	Circulation pump1 (local supply)	✓		
3	Flow switch1 (local supply) *2	✓		
4	Immersion heater (local supply)	✓		
5	Flow temp. thermistor (THW1)	✓		
6	Return temp. thermistor (THW2)	✓		
7	Tank water temp. (THW5)	✓		
8	Slave1 circulation pump1 (field supply)		✓	
9	Slave1 flow switch (local supply) *2		✓	
10	Slave1 3-way valve (local supply) *3		✓	
11	Slave1 flow temp. thermistor (THW1)		✓	
12	Slave1 return temp. thermistor (THW2)		✓	
13	Slave1 ref. liquid temp. thermistor (TH2) *1		✓	
14	Slave2 circulation pump1 (local supply)			✓
15	Slave2 flow switch (local supply) *2			✓
16	Slave2 flow temp. thermistor (THW1)			✓
17	Slave2 return temp. thermistor (THW2)			✓
18	Slave2 ref. liquid temp. thermistor (TH2) *1			✓

*1 When the outdoor unit is split type, TH2 needs to be installed.
<Fig. 9.2.1>

*2 For safety protection, it is recommended to install a flow switch.

*3 The use of two 2-way valves can perform the same function as a 3-way valve.

*4 DHW operation requires to use the master unit (or hydro box) as the slave controller.

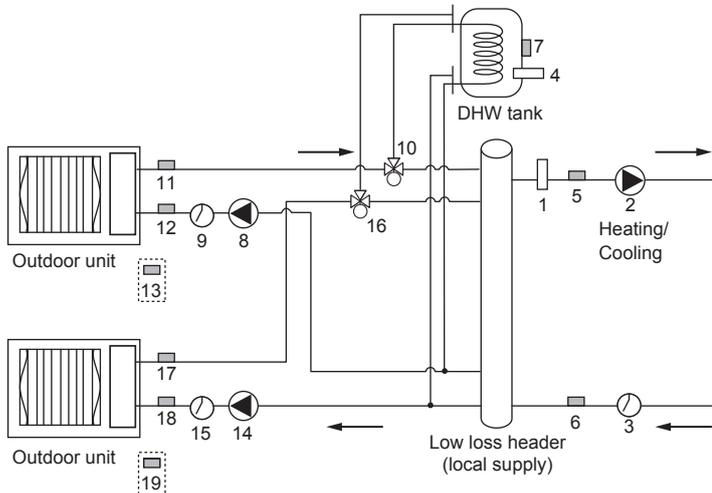

<Fig. 9.2.4>

No.	Component	Wiring		
		Master	Slave 1 *4	Slave 2 *4
1	Booster heater (local supply)	✓		
2	Circulation pump1 (local supply)	✓		
3	Flow switch1 (local supply) *2	✓		
4	Immersion heater (local supply)	✓		
5	Flow temp. thermistor (THW1)	✓		
6	Return temp. thermistor (THW2)	✓		
7	Tank water temp. (THW5)	✓		
8	Slave1 circulation pump1 (local supply)		✓	
9	Slave1 flow switch (local supply) *2		✓	
10	Slave1 3-way valve (local supply) *3		✓	
11	Slave1 flow temp. thermistor (THW1)		✓	
12	Slave1 return temp. thermistor (THW2)		✓	
13	Slave1 ref. liquid temp. thermistor (TH2) *1		✓	
14	Slave2 circulation pump1 (local supply)			✓
15	Slave2 flow switch (local supply) *2			✓
16	Slave2 3-way valve (local supply) *3			✓
17	Slave2 flow temp. thermistor (THW1)			✓
18	Slave2 return temp. thermistor (THW2)			✓
19	Slave2 ref. liquid temp. thermistor (TH2) *1			✓

*1 When the outdoor unit is split type, TH2 needs to be installed.
<Fig. 9.2.1>

*2 For safety protection, it is recommended to install a flow switch.

*3 The use of two 2-way valves can perform the same function as a 3-way valve.

*4 DHW operation requires to use the master unit (or hydro box) as the slave controller.

System 3: 2-zone temperature control

- Install a mixing tank (local supply) for 2-zone temperature control.
- Install a low loss header (local supply).
- Install booster heater toward the local system, relative to the low loss header.
- For details on 2-zone installation, refer to "3.6 Piping diagram for 2-zone temperature control".

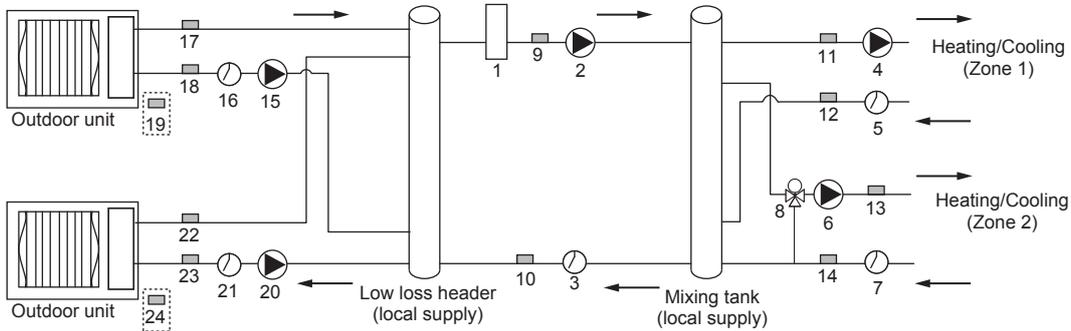

<Fig. 9.2.5>

No.	Component	Wiring		
		Master	Slave 1	Slave 2
1	Booster heater (local supply)	✓		
2	Circulation pump1 (local supply)	✓		
3	Flow switch1 (local supply) *2	✓		
4	Circulation pump2 (local supply)	✓		
5	Flow switch2 (local supply) *2	✓		
6	Circulation pump3 (local supply)	✓		
7	Flow switch3 (local supply) *2	✓		
8	Motorized mixing valve (local supply)	✓		
9	Flow temp. thermistor (THW1)	✓		
10	Return temp. thermistor (THW2)	✓		
11	Zone1 flow temp. thermistor (THW6) (option)	✓		
12	Zone1 return temp. thermistor (THW7) (option)	✓		

No.	Component	Wiring		
		Master	Slave 1	Slave 2
13	Zone2 flow temp. thermistor (THW8) (option)	✓		
14	Zone2 return temp. thermistor (THW9) (option)	✓		
15	Slave1 circulation pump1 (local supply)		✓	
16	Slave1 flow switch (local supply) *2		✓	
17	Slave1 flow temp. thermistor(THW1)		✓	
18	Slave1 return temp. thermistor (THW2)		✓	
19	Slave1 ref. liquid temp. thermistor (TH2) *1		✓	
20	Slave2 circulation pump1 (local supply)			✓
21	Slave2 flow switch (local supply) *2			✓
22	Slave2 flow temp. thermistor (THW1)			✓
23	Slave2 return temp. thermistor (THW2)			✓
24	Slave2 ref. liquid temp. thermistor (TH2) *1			✓

*1 When the outdoor unit is split type, TH2 needs to be installed. <Fig. 9.2.1>

*2 For safety protection, it is recommended to install a flow switch.

System 4: Heating/Cooling system (with Boiler)

- Install a mixing tank (local supply) for connection of the boiler.
- Install a low loss header (local supply).
- Install booster heater between low loss header and mixing tank.
- For more details, refer to the installation manual of PAC-TH011HT-E.

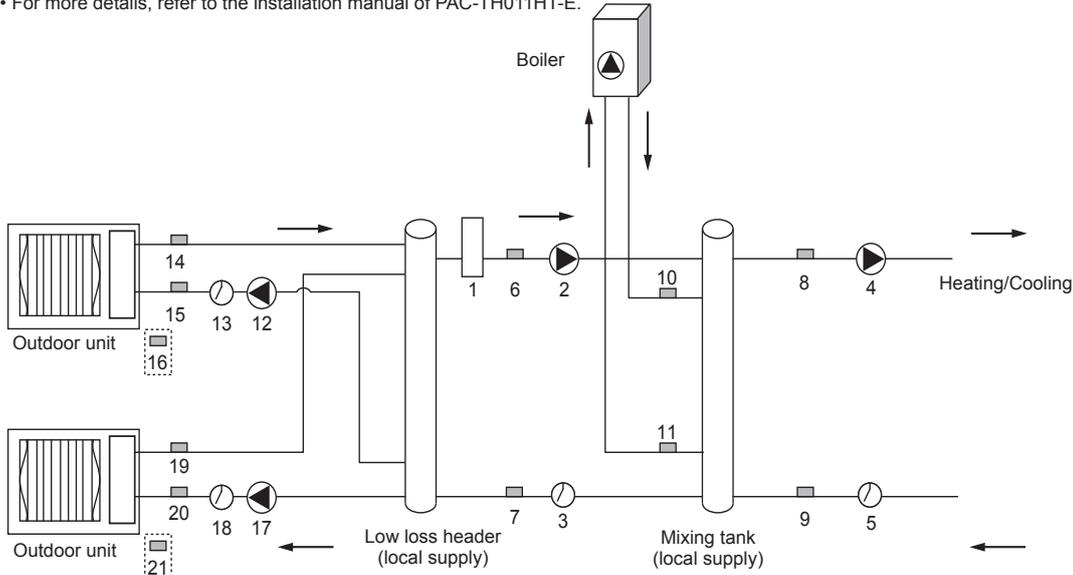

<Fig. 9.2.6>

No.	Component	Wiring		
		Master	Slave 1	Slave 2
1	Booster heater (local supply)	✓		
2	Circulation pump1 (local supply)	✓		
3	Flow switch1 (local supply) *2	✓		
4	Circulation pump2 (local supply)	✓		
5	Flow switch2 (local supply) *2	✓		
6	Flow temp. thermistor (THW1)	✓		
7	Return temp. thermistor (THW2)	✓		
8	Flow temp. thermistor (THW6) (option)	✓		
9	Return temp. thermistor (THW7) (option)	✓		
10	Boiler flow temp. thermistor (THWB1) (option)	✓		

No.	Component	Wiring		
		Master	Slave 1	Slave 2
11	Boiler return temp. thermistor (THWB2) (option)	✓		
12	Slave1 circulation pump1 (local supply)		✓	
13	Slave1 flow switch (local supply) *2		✓	
14	Slave1 flow temp. thermistor (THW1)		✓	
15	Slave1 return temp. thermistor (THW2)		✓	
16	Slave1 ref. liquid temp. thermistor (TH2) *1		✓	
17	Slave2 circulation pump1 (local supply)			✓
18	Slave2 flow switch (local supply) *2			✓
19	Slave2 flow temp. thermistor (THW1)			✓
20	Slave2 return temp. thermistor (THW2)			✓
21	Slave2 ref. liquid temp. thermistor (TH2) *1			✓

*1 When the outdoor unit is split type, TH2 needs to be installed. <Fig. 9.2.1>

*2 For safety protection, it is recommended to install a flow switch.

System 5: Heating/Cooling system (with Hydrobox)*1

- Install a low loss header (local supply).
- Install booster heater toward the local system, relative to the low loss header.

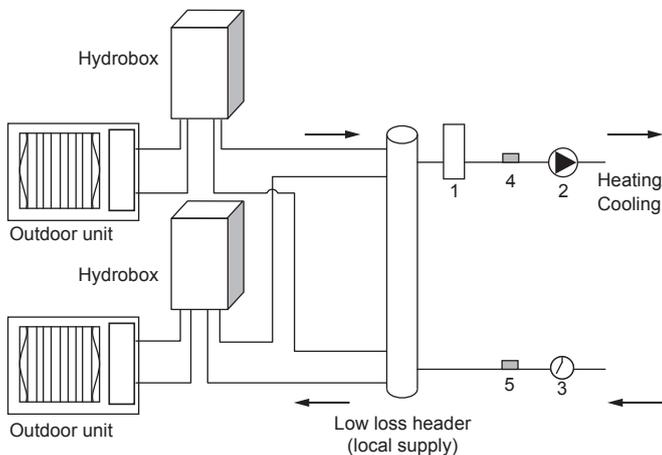

<Fig. 9.2.7>

No.	Component	Wiring		
		Master	Slave 1 (Hydrobox)	Slave 2 (Hydrobox)
1	Booster heater(local supply)	✓		
2	Circulation pump1 (local supply)	✓		
3	Flow switch1 (local supply) *2	✓		
4	Flow temp. thermistor (THW1)	✓		
5	Return temp. thermistor (THW2)	✓		

*1 Cooling system is available only with ERS models.

*2 For safety protection, it is recommended to install a flow switch.

9.3 Electrical connection

All electrical work should be carried out by a suitably qualified technician. Failure to comply with this could lead to electrocution, fire, and death. It will also invalidate product warranty. All wiring should be according to national wiring regulations.

9.3.1 Master unit

■ FTC (Master)

Outdoor unit must NOT be connected to FTC (Master) unit.

FTC (Master) unit electrical box connector connections changed. (see Fig. 9.3.2.)

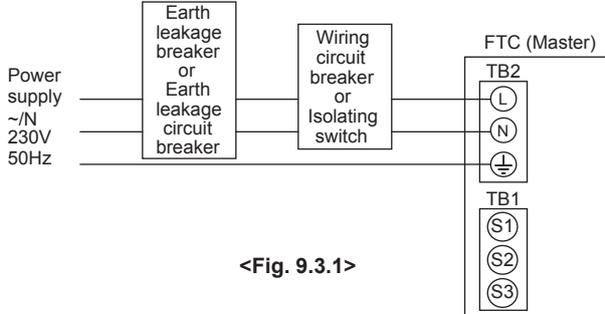

<Fig. 9.3.1>

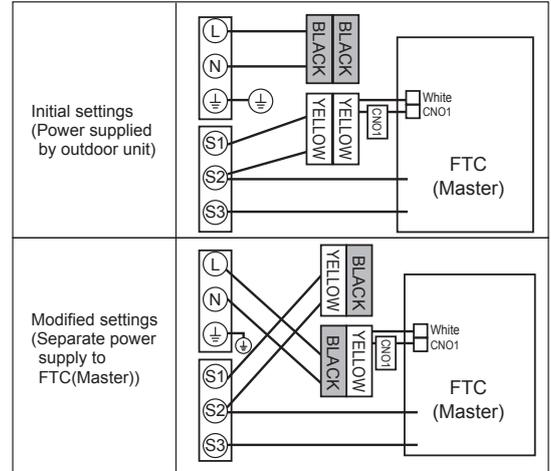

<Fig. 9.3.2>

9.3.2 Slave unit

Connect each outdoor unit to a slave unit.

FTC (Slave) can be powered in two ways.

1. Power cable is run from the outdoor unit to a slave unit.
2. FTC (Slave) has independent power source.

■ FTC (Master) (PAC-IF061B-E) used as slave

• For wiring as a slave controller, refer to "4.1 Electrical connection". *1

*1 Do not connect the power cable to the booster heater because it does not work in slave controller setting.

■ FTC (Slave) (PAC-SIF051B-E) <Fig. 9.3.3>

FTC (Slave) can be powered in two ways.

1. Power cable is run from the outdoor unit to FTC (Slave).
2. FTC (Slave) has independent power source.

Note:

- Do not run the low voltage cables through a slot that the high voltage cables go through.
- Bundle cables by using clamps as shown in the figure to the right .

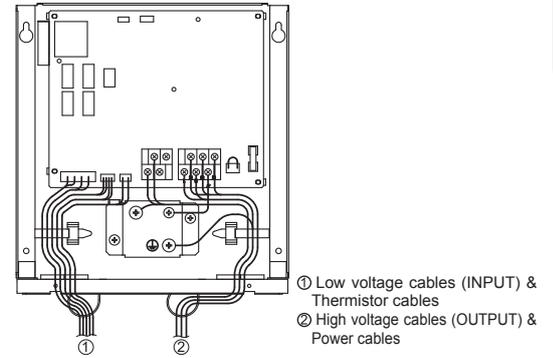

<Fig. 9.3.3>

Option 1: FTC (Slave) powered via outdoor unit

<1 phase>

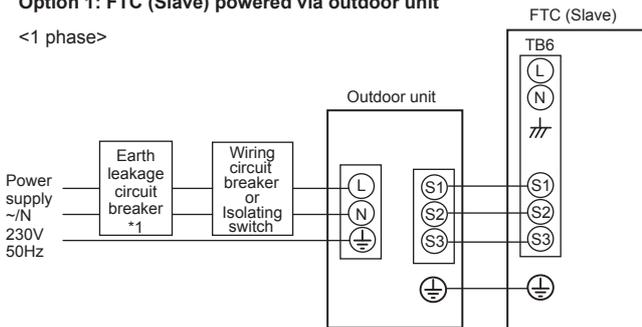

<3 phase>

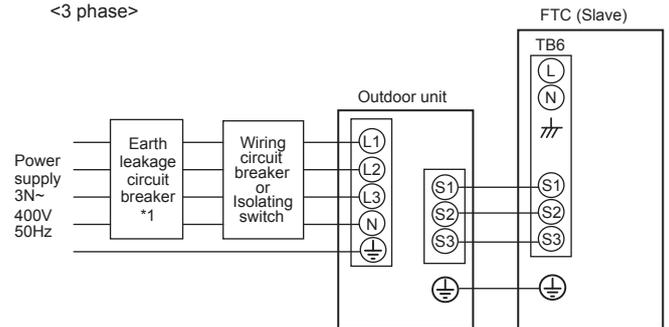

<Fig. 9.3.4>

*1 If the installed earth leakage circuit breaker does not have an over-current protection function, install a breaker with that function along the same power line.

A breaker with at least 3.0 mm contact separation in each pole shall be provided. Use earth leakage breaker (NV).

The breaker shall be provided to ensure disconnection of all active phase conductors of the supply.

Note: In accordance with IEE regulations the circuit breaker/isolating switch located on the outdoor unit should be installed with lockable devices (health and safety).

Wiring No. x size (mm ²)			
Circuit rating	FTC (Slave) - Outdoor unit	*2	3 × 1.5 (polar)
	FTC (Slave) - Outdoor unit earth	*2	1 × Min. 1.5
Circuit rating	FTC (Slave) - Outdoor unit S1 - S2	*3	230V AC
	FTC (Slave) - Outdoor unit S2 - S3	*3	24V DC

- *2. Max. 45 m
If 2.5 mm² used, Max. 50 m
If 2.5 mm² used and S3 separated, Max. 80 m

*3. The values given in the table above are not always measured against the ground value.

- Notes:**
1. Wiring size must comply with the applicable local and national codes.
 2. FTC (Slave)/outdoor unit connecting cords shall not be lighter than polychloroprene sheathed flexible cord. (Design 60245 IEC 57)
FTC (Slave) power supply cords shall not be lighter than polychloroprene sheathed flexible cord. (Design 60227 IEC 53)
 3. Install an earth longer than other cables.

Option 2: FTC (Slave) powered by independent source

If FTC (Slave) and outdoor units have separate power supplies, the following requirements MUST be carried out:

- Remove the short-circuited connector (CNS2) on FTC (Slave). (see <Fig. 9.3.5>)
- Turn the outdoor unit DIP switch SW8-3 to ON.
- Turn on the outdoor unit BEFORE the FTC (Slave).

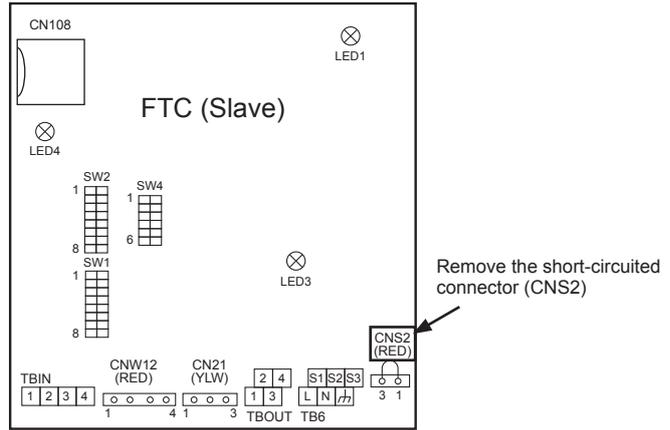

<Fig. 9.3.5>

<1 phase>

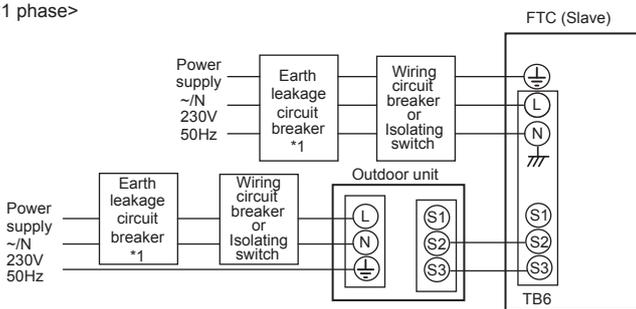

<3 phase>

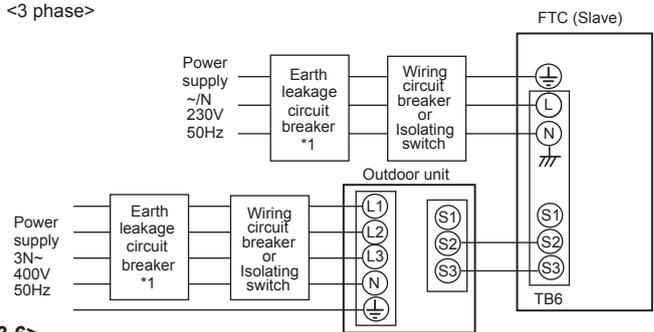

<Fig. 9.3.6>

*1 If the installed earth leakage circuit breaker does not have an over-current protection function, install a breaker with that function along the same power line.

FTC (Slave) power supply		~N 230 V 50 Hz
FTC (Slave) input capacity		
Main switch (Breaker)		*1 16 A
Wiring No. Wiring size (mm ²)	FTC (Slave) power supply	2 × Min. 1.5
	FTC (Slave) power supply earth	1 × Min. 1.5
	FTC (Slave) - Outdoor unit	*2 2 × Min. 0.3
	FTC (Slave) - Outdoor unit earth	—
Circuit rating	FTC (Slave) L - N	*3 230V AC
	FTC (Slave) - Outdoor unit S1 - S2	*3 —
	FTC (Slave) - Outdoor unit S2 - S3	*3 24V DC

*1. A breaker with at least 3.0 mm contact separation in each pole shall be provided. Use earth leakage breaker (NV). The breaker shall be provided to ensure disconnection of all active phase conductors of the supply.

*2. Max. 45 m

If 2.5 mm² used, Max. 50 m

If 2.5 mm² used and S3 separated, Max. 80 m

*3. The values given in the table above are not always measured against the ground value.

Notes: 1. Wiring size must comply with the applicable local and national codes.

2. FTC (Slave)/outdoor unit connecting cords shall not be lighter than polychloroprene sheathed flexible cord. (Design 60245 IEC 57)

FTC (Slave) power supply cords shall not be lighter than polychloroprene sheathed flexible cord. (Design 60227 IEC 53)

3. Install an earth longer than other cables.

Hydrobox

• For wiring as a slave controller (hydrobox), refer to "4.4 Electrical Connection" in Hydrobox installation manual.

Notes: 1. Do not connect the power cable to the booster heater because it doesn't work in slave controller setting.

2. Do not connect the main remote controller cable.

<Before system set up>

Insert the included SD memory card into the FTC control board. (Refer to section 4.11.)

9.4 Main remote controller wiring

- (a) Wire the main remote controller to TBI.2 RC terminals on the master unit. The main remote controller must NOT be connected to a slave unit.
 - (b) Use the daisy chain wiring method to wire the master unit and slave units by connecting TBI.2 RC terminals. *1
- *1 The maximum length between each units wiring is 10 m. The maximum length of total daisy-chain wiring is 500 m.

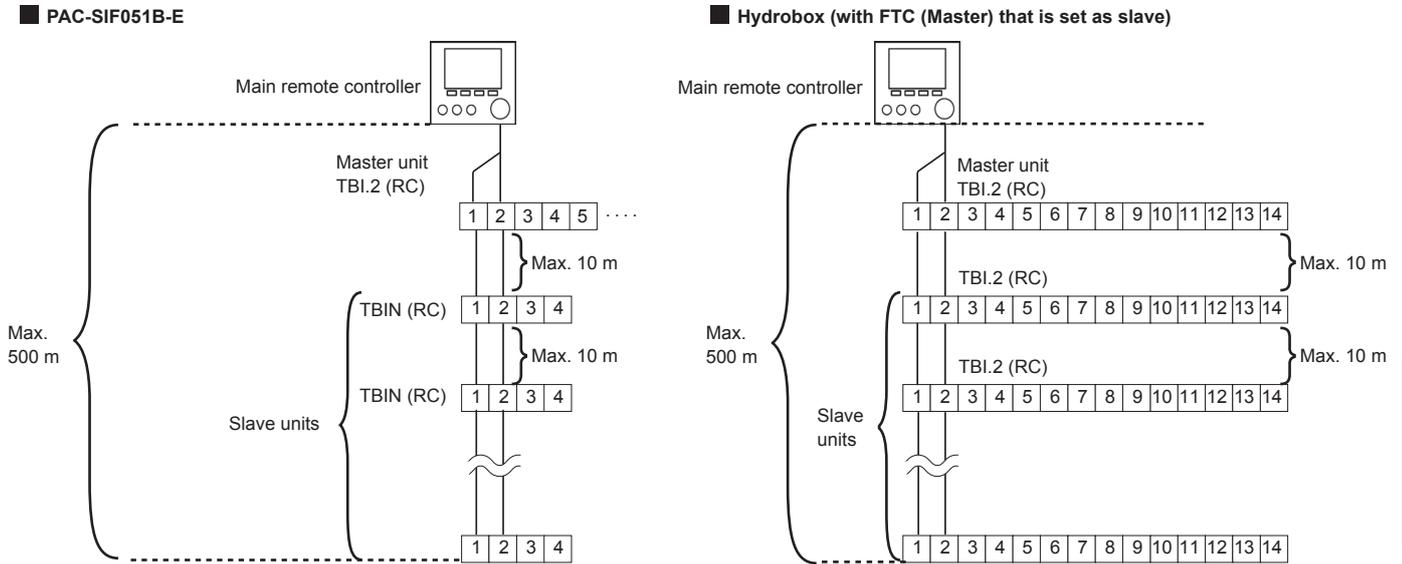

<Fig. 9.4.1>

Note: Wiring for main remote controller cable and daisy chain cable shall be (5 cm or more) apart from power source wiring so that it is not influenced by electrical noise from power source wiring. (Do NOT insert main remote controller cable and power source wiring in the same conduit.)

9.5. Connecting the thermistor cables

Connect the thermistor for the FTC (Slave) controller.

9.5.1. Connecting the refrigerant pipe temp. thermistor (TH2) cable

Connect the TH2 cable to the CN21 connector on FTC (Slave).

- For split Outdoor unit : Connect TH2.
- For packaged Outdoor unit : It is NOT necessary to connect TH2.

When the TH2 cable is too long, bundle the excess cable outside the FTC (Slave) unit.
Do not bind the wires in the FTC (Slave) unit.

<Thermistor position>

Place TH2 on **refrigerant** piping (**liquid** side).

It is recommended to protect the thermistor with heat insulating materials so as not to be affected by ambient temperature.

Note: Be sure to place TH2 where it correctly detects refrigerant piping temp. (liquid side).

Because;

- (1) TH2 is required to detect heating subcool correctly.
- (2) Refrigerant temperature of water-to-refrigerant heat exchanger also needs to be detected for protection purpose.

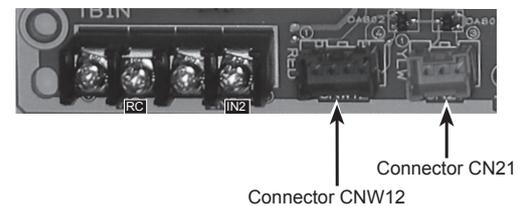

<Fig. 9.5.1>

9.5.2. Connecting the flow water temp. thermistor (THW1) cable and the return water temp. thermistor (THW2) cable

The THW1 and the THW2 cables share a connector, and the connector connects to CNW12 connector on FTC (Slave).

When the THW1 and THW2 cables are too long, bundle the excess cables outside the FTC (Slave) unit.
Do not bind the wires in the FTC (Slave) unit.

<Thermistor position>

Place THW1 on **water** piping (water **outlet** side) after booster heater, and THW2 on the water inlet side.

It is recommended to protect the thermistor with heat insulating materials so as not to be affected by ambient temperature.

Note: Be sure to attach THW1 where it correctly detects Flow temp. (water outlet side). For more details, see Page C-7.

⚠ Caution:

- Do not route the thermistor cables together with power cables.
- The sensor part of the thermistor should be installed where user can not access.

9.6 Dip switch functions

<Outdoor unit>

- Set refrigerant address on each outdoor unit from 1 to 6.

Note: Do NOT use refrigerant address 0 as 0 is used for FTC (Master). The address range is from 1 to 6.

Split model (SW1-3 to SW1-6)

Dip switch	Refrigerant address number					
	Add. 1	Add. 2	Add. 3	Add. 4	Add. 5	Add. 6
SW1-1	—	—	—	—	—	—
SW1-2	—	—	—	—	—	—
SW1-3	ON	OFF	ON	OFF	ON	OFF
SW1-4	OFF	ON	ON	OFF	OFF	ON
SW1-5	OFF	OFF	OFF	ON	ON	ON
SW1-6	OFF	OFF	OFF	OFF	OFF	OFF

Packaged model (SW7-3 to SW7-6)

Dip switch	Refrigerant address number					
	Add. 1	Add. 2	Add. 3	Add. 4	Add. 5	Add. 6
SW7-1	—	—	—	—	—	—
SW7-2	—	—	—	—	—	—
SW7-3	ON	OFF	ON	OFF	ON	OFF
SW7-4	OFF	ON	ON	OFF	OFF	ON
SW7-5	OFF	OFF	OFF	ON	ON	ON
SW7-6	OFF	OFF	OFF	OFF	OFF	OFF

<FTC: Master>

- Set Dip SW4-1 and SW4-2 to ON.
- For more details refer to "5. Dip Switch setting."

<FTC: Slave>

- Set Dip SW4-1 to ON "Active :multiple outdoor unit control".
- Set Dip SW1-7 (Outdoor unit type) on each slave unit according to each connected outdoor unit type.
- Set only Dip-SW1-3 to ON on the slave unit that runs DHW operation.

Dip switch	Function	OFF	ON	Master	Slave (PAC-SIF051B-E)	Slave *1 (Hydrobox)
SW1	SW1-1	Bolier	WITHOUT Bolier	WITH Bolier	✓	—
	SW1-2	Heat pump maximum outlet water temperature	55°C	60°C	✓	✓
	SW1-3	DHW tank	WITHOUT DHW tank	WITH DHW tank	✓	✓
	SW1-4	Immersion heater	WITHOUT Immersion heater	WITH Immersion heater	✓	—
	SW1-5	Booster heater	WITHOUT Booster heater	WITH Booster heater	✓	—
	SW1-6	Booster heater function	For heating only	For heating and DHW	—	—
	SW1-7	Outdoor unit type	Split type	Packaged type	—	✓
	SW1-8	Wireless remote controller	WITHOUT Wireless remote controller	WITH Wireless remote controller	✓	—
SW2	SW2-1	Room thermostat1 input (IN1) logic change	Zone1 operation stop at short	Zone1 operation stop at open	✓	—
	SW2-2	Flow switch1 input (IN2) logic change	Failure detection at short	Failure detection at open	✓	✓
	SW2-3	Booster heater capacity restriction	Inactive	Active	✓	—
	SW2-4	Cooling mode function	Inactive	Active	✓	—
	SW2-5	"Automatic switch to backup heater only operation (When outdoor unit stops by error)"	Inactive	Active	✓	—
	SW2-6	Mixing tank	WITHOUT Mixing tank	WITH Mixing tank	✓*2	—
	SW2-7	2-zone temperature control	Inactive	Active	✓	—
	SW2-8	Flow sensor	WITHOUT Flow sensor	WITH Flow sensor	✓	—
SW3	SW3-1	Room thermostat2 input (IN6) logic change	Zone2 operation stop at short	Zone2 operation stop at open	✓	—
	SW3-2	Flow switch2 input (IN3) logic change	Failure detection at short	Abnormality detection at open	✓	—
	SW3-3	Flow switch3 input (IN7) logic change	Failure detection at short	Abnormality detection at open	✓	—
	SW3-4	—	—	—	—	—
	SW3-5	Heating mode function	Inactive	Active	✓	—
	SW3-6	2-zone valve ON/OFF control	Inactive	Active	✓	—
	SW3-7	—	—	—	—	—
	SW3-8	—	—	—	—	—
SW4	SW4-1	Multiple unit control	Inactive	Active	ON	ON
	SW4-2	Position of multiple outdoor units control	Slave	Master	ON	OFF
	SW4-3	—	—	—	—	—
	SW4-4	—	—	—	—	—
	SW4-5	Emergency mode (Heater only operation)	Normal	"Emergency mode (Heater only operation) (To be activated only when powered ON)"	✓	—
	SW4-6	Emergency mode (Bolier operation)	Normal	"Emergency mode (Bolier operation) (To be activated only when powered ON)"	✓	—
SW5	SW5-1	—	—	—	—	—
	SW5-2	Advanced auto adaptation	Inactive	Active	✓	—
	SW5-3	—	—	—	—	—
	SW5-4	—	—	—	—	—
	SW5-5	—	—	—	—	—
	SW5-6	—	—	—	—	—
	SW5-7	—	—	—	—	—
	SW5-8	—	—	—	—	—

*1 When FTC (Master) in Hydrobox is set as Slave.

*2 Set Dip SW2-6 to ON in "System 3 (2 zone)" and in "System 4 (with Boiler)" mentioned in "9.2 Pipe work."

✓ : Setting is required

— : NO setting (function is not available)

9.7 Connecting inputs/outputs

When the wires are wired to adjacent terminals use ring terminals and insulate the wires.

<Electrical connection for master controller>

- Refer to "4.5 Connecting inputs/outputs"

<Electrical connection for slave controller>

■ PAC-IF06*B-E

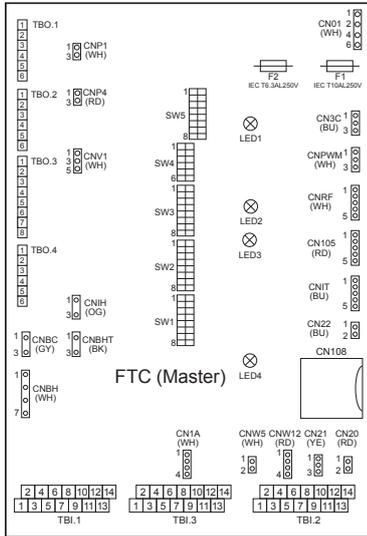

<Fig. 9.7.1>

When the wires are wired to adjacent terminals use ring terminals and insulate the wires.

Signal inputs

Name	Terminal block	Connector	Item	OFF (Open)	OFF (Short)
RC	TBI.2 1-2	—	Communication cable between indoor units	—	—
IN2	TBI.1 11-12	—	Flow switch 1 input	Refer to SW2-2 in <9.6 Dip Switch Functions>.	

Wiring specification and local supply parts

Item	Name	Model and specifications
Signal input function	Signal input wire	Use sheathed vinyl coated cord or cable. Max. 10 m Wire type: CV, CVS or equivalent Wire size: Stranded wire 0.13 mm ² to 1.25 mm ² Solid wire: ø0.4 mm to ø1.2 mm
	Switch	Non-voltage "a" contact signals Remote switch: minimum applicable load 12V DC, 1mA

Thermistor inputs

Name	Terminal block	Connector	Item	Optional part model
TH2	—	CN21	Thermistor (Ref. liquid temp.)	—
THW1	—	CNW12 1-2	Thermistor (Flow water temp.)	—
THW2	—	CNW12 3-4	Thermistor (Return water temp.)	—

Note:

Do not splice the wiring to extend or shorten it, or this could affect correct monitoring of each temperature.
If the wiring is too long, bundle it with a strap to adjust the length.

Outputs

Name	Terminal block	Connector	Item	OFF	ON	Signal/Max. current
OUT1	TBO.1 1-2	CNP1	Water circulation pump 1 output	OFF	ON	230V AC 1.0 A Max.
OUT4	TBO.2 4-6	CNV1	3-way valve (2-way valve 1) output	Heating	DHW	230V AC 0.1 A Max.
OUT13	TBO.4 1-2	—	2-way valve 2 output	DHW	Heating	230V AC 0.1 A Max.

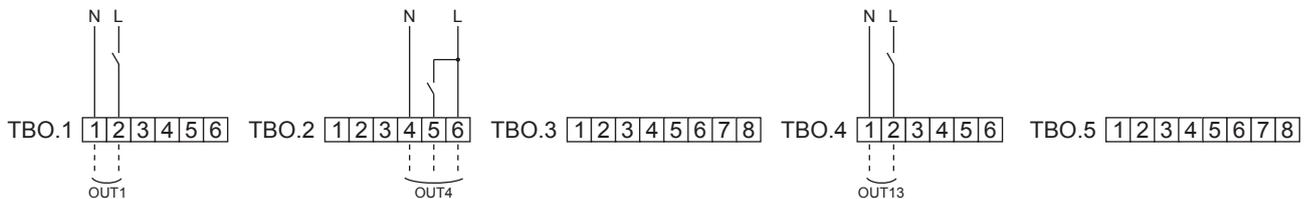

<Fig. 9.7.2>

Wiring specification and local supply parts

Item	Name	Model and specifications
External output function	Outputs wire	Use sheathed vinyl coated cord or cable. Max. 30 m Wire type: CV, CVS or equivalent Wire size: Stranded wire 0.25 mm ² to 1.5 mm ² Solid wire: 0.25 mm ² to 1.5 mm ²

How to use TBO.1 to 5

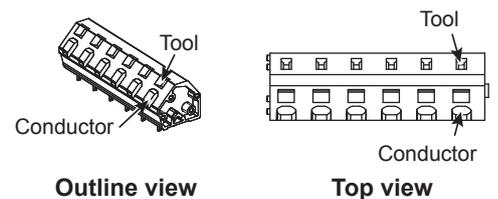

Connect them using either way as shown above.

<Fig. 9.7.3>

Note:

1. Do not connect multiple water circulation pumps directly to each output (OUT1). In such a case, connect them via (a) relay(s).
2. Stranded wire should be processed with insulation-covered bar terminal (DIN46228-4 standard compatible type).

■ PAC-SIF051B-E

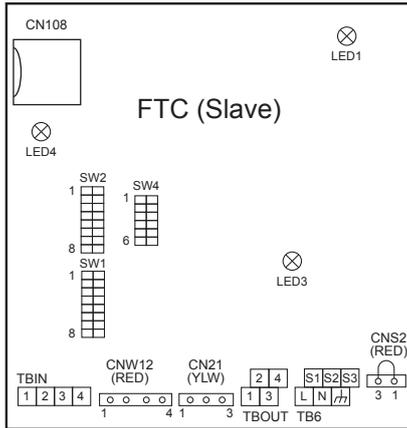

<Fig. 9.7.4>

Signal inputs

Name	Terminal block	Connector	Item	OFF (Open)	OFF (Short)
RC	TBIN 1-2	—	Communication cable between indoor units	—	—
IN2	TBIN 3-4	—	Flow switch input	Refer to SW2-2 in <9.6 Dip Switch Functions>.	

Wiring specification and local supply parts

Item	Name	Model and specifications
Signal input function	Signal input wire	Use sheathed vinyl coated cord or cable. Max. 10 m Wire type: CV, CVS or equivalent Wire size: Stranded wire 0.5 mm ² to 1.25 mm ² Solid wire: ø0.65 mm to ø1.2 mm
	Switch	Non-voltage "a" contact signals Remote switch: minimum applicable load 12V DC, 1mA

Thermistor inputs

Name	Terminal block	Connector	Item	Optional part model
TH2	—	CN21	Thermistor (Ref. liquid temp.)	—
THW1	—	CNW12 1-2	Thermistor (Flow water temp.)	—
THW2	—	CNW12 3-4	Thermistor (Return water temp.)	—

Note:

Do not splice the wiring to extend or shorten it, or this could affect correct monitoring of each temperature.
If the wiring is too long, bundle it with a strap to adjust the length.

Output

Name	Terminal block	Connector	Item	OFF	ON	Signal/Max. current
OUT1	TBOUT 1-2	—	Water circulation pump 1 output	OFF	ON	230V AC 1.0 A Max.

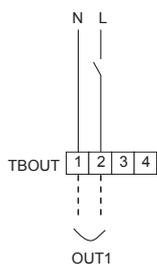

<Fig. 9.7.5>

Wiring specification and local supply parts

Item	Name	Model and specifications
External output function	Outputs wire	Use sheathed vinyl coated cord or cable. Max. 30 m Wire type: CV, CVS or equivalent Wire size: Stranded wire 0.5 mm ² to 1.25 mm ² Solid wire: ø0.65 mm to ø1.2 mm

Note: Do not connect multiple water circulation pumps directly to each output (OUT1). In such a case, connect them via (a) relay(s).

Flow temp.controller

Hydrobox

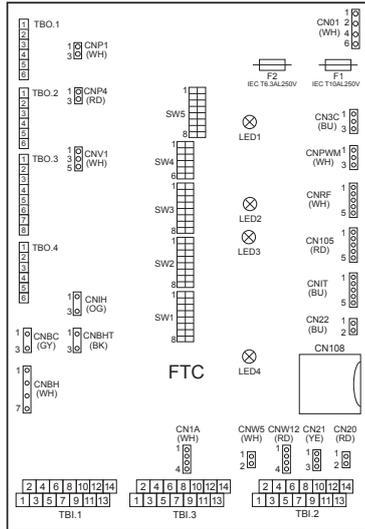

When the wires are wired to adjacent terminals use ring terminals and insulate the wires.

<Fig. 9.7.6>

Signal inputs

Name	Terminal block	Connector	Item	OFF (Open)	OFF (Short)
RC	TBI.2 1-2	CN22	Communication cable between indoor units	—	—
IN2	TBI.1 11-12	—	Flow switch input	Refer to SW2-2 in <9.6 Dip Switch Functions>.	

Wiring specification and local supply parts

Item	Name	Model and specifications
Signal input function	Signal input wire	Use sheathed vinyl coated cord or cable. Max. 10 m Wire type: CV, CVS or equivalent Wire size: Stranded wire 0.5 mm ² to 1.25 mm ² Solid wire: ø0.65 mm to ø1.2 mm
	Switch	Non-voltage "a" contact signals Remote switch: minimum applicable load 12V DC, 1mA

Thermistor inputs

Name	Terminal block	Connector	Item	Optional part model
TH2	—	CN21	Thermistor (Ref. liquid temp.)	—
THW1	—	CNW12 1-2	Thermistor (Flow water temp.)	—
THW2	—	CNW12 3-4	Thermistor (Return water temp.)	—

Note:

Do not splice the wiring to extend or shorten it, or this could affect correct monitoring of each temperature.
If the wiring is too long, bundle it with a strap to adjust the length.

Outputs

Name	Terminal block	Connector	Item	OFF	ON	Signal/Max. current
OUT1	TBO.1 1-2	CNP1	Water circulation pump 1 output	OFF	ON	230V AC 1.0 A Max.
OUT4	TBO.2 4-6	CNV1	3-way valve (2-way valve 1) output	Heating	DHW	230V AC 0.1 A Max.
OUT13	TBO.4 1-2	—	2-way valve 2 output	DHW	Heating	230V AC 0.1 A Max.

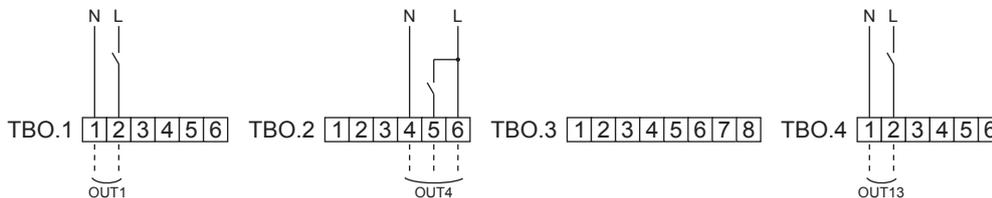

<Fig. 9.7.7>

Wiring specification and local supply parts

Item	Name	Model and specifications
External output function	Outputs wire	Use sheathed vinyl coated cord or cable. Max. 30 m Wire type: CV, CVS or equivalent Wire size: Stranded wire 0.25 mm ² to 1.5 mm ² Solid wire: 0.25 mm ² to 1.5 mm ²

Note:

- Do not connect multiple water circulation pumps directly to each output (OUT1). In such a case, connect them via (a) relay(s).
- Do not connect water circulation pumps to both TBO.1 1-2 and CNP1 at the same time.
- Stranded wire should be processed with insulation-covered bar terminal (DIN46228-4 standard compatible type).

How to use TBO.1 to 4

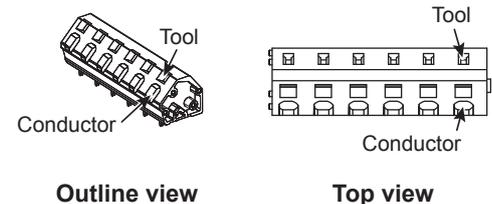

Connect them using either way as shown above.

<Fig. 9.7.8>

Basic Troubleshooting for multiple outdoor units control

No.	Fault symptom	Possible cause	Explanation - Solution
1	Main remote controller display is blank.	<ol style="list-style-type: none"> There is no power supply to main remote controller. Power is supplied to the main remote controller, however, the display on the main remote controller does not appear. 	<ol style="list-style-type: none"> Check LED2 on the master controller. (See <Figure 4.5.1>.) <ol style="list-style-type: none"> When LED2 is lit. Check for damage or contact failure of the main remote controller wiring. When LED2 is blinking. Refer to No. 4 below. When LED2 is not lit. Refer to No. 3 below. Check the following: <ul style="list-style-type: none"> Disconnection between the main remote controller cable and the master controller. Failure of the main remote controller if "Please Wait" is not displayed. Refer to No. 2 below if "Please Wait" is displayed.
2	"Please Wait" remains displayed on the main remote controller.	<ol style="list-style-type: none"> "Please Wait" is displayed for up to 6 minutes. Communication failure between the main remote controller and master/slave controller. Communication failure between slave controller and outdoor unit. 	<ol style="list-style-type: none"> Normal operation. ,3. Main remote controller start up checks/procedure. <ol style="list-style-type: none"> If "0%" or "50-99%" is displayed below "Please Wait" there is a communication error between the main remote controller and the master/slave controller. <ul style="list-style-type: none"> Check wiring connections on the main remote controller. Replace the main remote controller or master/slave controller. If "1-49%" is displayed there is a communication error between the outdoor unit's control board and slave controller. <ul style="list-style-type: none"> Check the wiring connections on the outdoor unit control board and the slave controller. (Ensure S1 and S2 are not cross-wired and S3 is securely wired with no damage. (See section 4.5.) Replace the outdoor unit's control board and/or the slave controller.
3	LED2 on master controller is off. (See <Figure 4.5.1>.)	<p>When LED1 on master controller is also off. (See <Figure 4.5.1>.)</p> <ol style="list-style-type: none"> Master controller is not supplied with 220 to 240V AC. There are problems in the method of connecting the connectors. Master controller failure 	<ol style="list-style-type: none"> Check the voltage across the L and N terminals on the indoor power supply terminal block. (See section 4.5.) <ul style="list-style-type: none"> When the voltage is not 220 to 240V AC, check for faulty wiring to power supply. When the voltage is 220 to 240V AC, go to 2. below. Check for faulty wiring between the connectors. <ul style="list-style-type: none"> When the connectors are wired incorrectly re-wire them correctly referring to below. (See section 4.5 and a wiring diagram on the control and electrical box cover.) <div style="text-align: center;"> </div> <ol style="list-style-type: none"> If no problem found with the wiring, go to 3. below. Check the master controller. <ul style="list-style-type: none"> Check the fuse on the master controller. Check for faulty wiring. Check Dip SW4-2 is ON. If no problem found with the wiring, the master controller is faulty.
4	LED2 on FTC is blinking. (See Figure <4.5.1>.)	<p>When LED1 is also blinking on master controller.</p> <p>When LED1 on master controller is lit.</p> <ol style="list-style-type: none"> Faulty wiring in main remote controller Multiple indoor units have been wired to a single outdoor unit. Short-circuited wiring in main remote controller Main remote controller failure Dip SW setting failure 	<p>Check for faulty wiring between master controllers.</p> <ol style="list-style-type: none"> Check for faulty wiring in main remote controller. The number of indoor units that can be wired to a single outdoor unit is one. Additional indoor units must be wired individually to a single outdoor unit. ,3. Remove main remote controller wires and check LED2 on master controller. (See Figure 4.5.1.) <ul style="list-style-type: none"> If LED2 is blinking check for short circuits in the main remote controller wiring. If LED2 is lit, wire the main remote controller again and: <ul style="list-style-type: none"> if LED2 is blinking, the main remote controller is faulty; if LED2 is lit, faulty wiring of the main remote controller has been corrected. Check Dip SW 4-2 on the slave controller is OFF.

For other details, refer to "8. Troubleshooting".

10.1 Refrigerant collecting (pumpdown) for split model systems only

Refer to "Refrigerant collection" in the outdoor unit installation manual or service manual.

10.2 Back-up operation of boiler

Heating operation is backed up by boiler.

For more details, refer to the installation manual of PAC-TH011HT-E.

<Installation & System set up>

1. Set Dip-SW 1-1 to ON "With boiler" and SW2-6 to ON "With Mixing tank".
2. Install the thermistors THWB1 (Flow temp.) and THWB2 (return temp.) *1 on the boiler circuit.
3. Connect the output wire (OUT10: Boiler operation) to the signal input (room thermostat input) on the boiler. *2
4. Install one of the following room temp. thermostats. *3

- Wireless remote controller (option)
- Room temp. thermostat (local supply)
- Main remote controller (remote position)

*1 The boiler temp. thermistor is an optional part.

*2 OUT10 has no voltage across it.

*3 Boiler heating is controlled on/off by the room temp. thermostat.

<Remote controller settings>

1. Go to Service menu > Heat source setting and choose "Boiler" or "Hybrid". *4
2. Go to Service menu > Operation settings > Boiler settings to make detailed settings for "Hybrid" above .

*4 The "Hybrid" automatically switches heat sources between Heat pump (and Electric heater) and boiler.

10.3 Product fiche of temperature control

(a) Supplier's name: MITSUBISHI ELECTRIC CORPORATION

(b) Supplier's model identifier: PAR-WT50R-E and PAR-WT51R-E

(c) The class of the temperature control: VI

(d) The contribution of the temperature control to seasonal space heating energy efficiency: 4%

Local application factors

- * This FTC is designed to connect Mr.Slim/Ecodan inverter outdoor unit of MITSUBISHI ELECTRIC to local systems. Please check the following when designing the local system.
- * MITSUBISHI ELECTRIC does not take any responsibility for the local system design.

Heat exchanger

(1) Withstanding pressure

Designed pressure of outdoor unit is 4.15 MPa. Following must be satisfied for burst pressure of connecting application.
Burst pressure: More than 12.45 MPa (3 times more than designed pressure)

(2) Performance

Secure the heat exchanger capacity which meets the following conditions. If the conditions are not met, it may result in malfunction caused by the protection operation or the outdoor unit may be turned off due to the operation of protection system.

- In case of hot water supply, condense temperature is less than 58°C in max. frequency operation with the outside temperature 7°C D.B./6°C W.B.

(3) Heat exchanger internal capacity

Heat exchanger internal capacity must be within the capacity range shown below. If the heat exchanger below the minimum capacity is connected, it may result in the back flow of liquid or the failure of the compressor.

If the heat exchanger above the maximum capacity is connected, it may result in the deficiency in performance due to lack of refrigerant or overheating of the compressor.

Outdoor unit	PUHZ-SW	40	50	75	100	—	120	160	200
	SUHZ-SW	—	45	—	—	—	—	—	—
	PUHZ-SHW	—	—	80	112	140	—	230	—
Maximum capacity [cm ³]	1050	1500	2130	3000	3750	4200	6000	7500	
Minimum capacity [cm ³]	350	500	710	1000	1250	1400	2000	2500	

(4) Contamination maintenance

1. Wash the inside of heat exchanger to keep it clean. Be sure to RINSE not to leave flux. Do not use chlorine detergent when washing.
2. Be sure that the amount of contamination per unit cubic content of heat transfer pipe is less than the following amount.

Example) In case of ϕ 9.52 mm

Residual water: 0.6 mg/m, Residual oil: 0.5 mg/m, Solid foreign object: 1.8 mg/m

Thermistor position

Refer to 4.4.

Notes

- Install the hydraulic filter at the water inlet pipework.
- Inlet water temperature of heat exchanger should be within the range 5 °C - 55 °C.
- The water in both primary and sanitary circuit should be clean and with pH value of 6.5-8.0
- The followings are the maximum values;
 - Calcium: 100 mg/L, Ca hardness: 250 mg/L
 - Chlorine: 100 mg/L, Copper: 0.3 mg/L
- Other constituents should be to European Directive 98/83 EC standards.
- Refrigerant pipe diameter from outdoor unit to refrigerant-water HEX (Only for SPLIT type)
 - Use the pipe with same diameter size as the refrigerant pipe connection diameter of outdoor unit. (Refer to outdoor unit installation manual.)
- Ensure that there is sufficient anti-freeze chemical in the water circuit. It is recommended to use 7 : 4 anti-freeze to water ratio.
- The water velocity in pipes should be kept within certain limits of material to avoid erosion, corrosion and excessive noise generation. Be aware, and take care of , that local velocities in small pipes, bends and similar obstructions can exceed the values above.
 - e.g.) Copper: 1.5 m/s

⚠ Warning:

- **Always use water that meets the above quality requirements. Using water that does not meet these standards may result in damage to the system pipework and heating components.**
- **Never use anything other than water as a medium. It may cause a fire or an explosion.**
- **Do not use heated water that is produced by the air to water heat pump directly for drinking or cooking. There is a risk to damage your health. There is also a risk that installing the water heat exchanger may corrode if the necessary water quality for air to water heat pump system cannot be maintained. If you wish to use the heated water from the heated pump for these purposes, take measure such as to the second heat exchanger within the water piping system.**

Contents

1	Optional parts list	D-2
2	ATW Wireless System	D-9
	1. Safety Precautions	D-9
	2. Accessories and Installation Tool	D-10
	3. Before using ATW Wireless System.....	D-10
	4. Installing Wireless Receiver	D-11
	5. Pairing process	D-16
	6. Setting wireless remote controllers	D-17
	7. Wireless Receiver Operation	D-20
	8. Q&A	D-22
	9. Specifications	D-23
3	Immersion Heater	D-24
4	EHPT Accessories for UK	D-28
5	HIGH TEMP. THERMISTOR	D-32
6	DRAIN PAN STAND	D-34
7	2 ZONE KIT	D-38

Optional parts

Optional parts

■ Packaged model

<Indoor unit (Cylinder unit)>

Parts name	Model name	Specification	Cylinder unit				
			EHPT20X-VM2C	EHPT20X-VM6C	EHPT20X-YM9C	EHPT20X-TM9C	EHPT20X-MHCW
Wireless remote controller	PAR-WT50R-E		✓	✓	✓	✓	✓
Wireless receiver	PAR-WR51R-E		✓	✓	✓	✓	✓
Thermistors	PAC-SE41TS-E	For room temp.	✓	✓	✓	✓	✓
	PAC-TH011-E	For buffer and zone (flow and return temp.)	✓	✓	✓	✓	✓
	PAC-TH011TK-E	For tank temp.	—	—	—	—	—
	PAC-TH011TKL-E	For tank temp. (longer)	—	—	—	—	—
	PAC-TH011HT-E	For boiler (flow and return temp.)	✓	✓	✓	✓	✓
Immersion heater	PAC-I03V2-E	1Ph 3kW	✓	✓	✓	✓	—
EHPT accessories for UK	PAC-WK01UK-E		—	—	—	—	✓
Wi-Fi interface	PAC-WF010-E		✓	✓	✓	✓	✓
2 zone kit	PAC-TZ01-E	D383 mm H265 mm W356 mm N/W18 kg	✓	✓	✓	✓	✓

<Indoor unit (Hydrobox)>

Parts name	Model name	Specification	Hydrobox		
			EHPX-VM2C	EHPX-VM6C	EHPX-YM9C
Wireless remote controller	PAR-WT50R-E		✓	✓	✓
Wireless receiver	PAR-WR51R-E		✓	✓	✓
Thermistors	PAC-SE41TS-E	For room temp.	✓	✓	✓
	PAC-TH011-E	For buffer and zone (flow and return temp.)	✓	✓	✓
	PAC-TH011TK-E	For tank temp.	✓	✓	✓
	PAC-TH011TKL-E	For tank temp. (longer)	✓	✓	✓
	PAC-TH011HT-E	For boiler (flow and return temp.)	✓	✓	✓
Wi-Fi interface	PAC-WF010-E		✓	✓	✓
2 zone kit	PAC-TZ01-E	D383 mm H265 mm W356 mm N/W18 kg	✓	✓	✓

<Outdoor unit>

Parts name	Model name	Power Inverter							ZUBADAN		
		PUHZ-W50 VHA2(-BS)	PUHZ-W85 VHA2(-BS)	PUHZ-W112 VHA (-BS)	PUHZ-W85 VAA	PUHZ-W85 YAA	PUHZ-W112 VAA	PUHZ-W112 YAA	PUHZ-HW112 YHA2(-BS)	PUHZ-HW140 VHA2(-BS)	PUHZ-HW140 YHA2(-BS)
Connector for Drain Hose Heater Signal Output	PAC-SE60RA-E	✓	✓	✓	✓	✓	✓	✓	✓	✓	✓
Air discharge Guide	PAC-SG59SG-E	✓	✓	✓	✓	✓	✓	✓	✓	✓	✓
Air Protection Guide	PAC-SH63AG-E	✓	✓	✓	✓	✓	✓	✓	✓	✓	✓
Drain Socket	PAC-SG61DS-E	✓	✓	✓	✓	✓	✓	✓	—	—	—
Centralized Drain Pan	PAC-SG64DP-E	✓	✓	—	✓	✓	—	—	—	—	—

<Interface/Flow temperature control>

Parts name	Model name	Specification	Power Inverter							ZUBADAN		
			PUHZ-W50 VHA2(-BS)	PUHZ-W85 VHA2(-BS)	PUHZ-W112 VHA (-BS)	PUHZ-W85 VAA	PUHZ-W85 YAA	PUHZ-W112 VAA	PUHZ-W112 YAA	PUHZ-HW112 YHA2(-BS)	PUHZ-HW140 VHA2(-BS)	PUHZ-HW140 YHA2(-BS)
Capacity step control interface	PAC-IF011B-E	1 PC Board w/ Case	✓	✓	✓	✓	✓	✓	✓	✓	✓	✓
Flow Temperature Controller	PAC-IF032B-E	1 PC Board w/ Case	✓	✓	✓	✓	✓	✓	✓	✓	✓	✓
System controllers	PAC-IF061B-E	1 PC Board w/ Case	✓	✓	✓	✓	✓	✓	✓	✓	✓	✓
	PAC-IF062B-E	1 PC Board w/ Case	✓	✓	✓	✓	✓	✓	✓	✓	✓	✓
	PAC-IF063B-E	1 PC Board w/ Case	✓	✓	✓	✓	✓	✓	✓	✓	✓	✓
	PAC-SIF051B-E	1 PC Board w/ Case	✓	✓	✓	✓	✓	✓	✓	✓	✓	✓
Thermistor	PAC-TH011-E		✓	✓	✓	✓	✓	✓	✓	✓	✓	✓

CONTENTS

Parts name	Model name	Contents	Q'ty
Air discharge Guide	PAC-SG59SG-E	Air Discharge guide	1
		Attachment screw(5×35)	4
		Spacer	4
Air Protection Guide	PAC-SH63AG-E	Air guide	1
		Mounting screw (5×15)	4
		Washer	4
		Spring washer	4
Drain Socket	PAC-SG61DS-E	Drain socket	1
		Drain cap (φ33)	5
		Heat insulator	3
		Band	8
Centralized Drain Pan	PAC-SG64DP-E	Centralized Drain Pan	1
Step Interface	PAC-IF011B-E	PC Board	1
		Case	1
		Thermistor	2
Flow Temperature Controller	PAC-IF032B-E	PC Board	1
		Case	1
		Thermistor	3
		Remote Controller	1
		Remote Controller Cable (5m)	1
	PAC-IF061B-E	PC Board	1
		Case	1
		Thermistor	1
		Flow/Return water temp. thermistor	1
		Remote Controller	1
		Remote Controller Cable (10m)	1
	SD memory card	1	
	PAC-IF062B-E	PC Board	1
		Case	1
		Flow/Return water temp. thermistor	1
		Remote Controller	1
		Remote Controller Cable (10m)	1
	PAC-IF063B-E	PC Board	1
		Case	1
		Tank thermistor	1
		Flow/Return water temp. thermistor	1
		Remote Controller	1
		Remote Controller Cable (10m)	1
	SD memory card	1	
PAC-SIF051B-E	PC Board	1	
	Case	1	
	Thermistor	1	
	Flow/Return water temp. thermistor	1	
	Remote Controller Cable (10m)	1	
	SD memory card	1	
Thermistors	PAC-TH011-E	For buffer and zone (flow and return temp.)	20 ²⁾
	PAC-TH011TK-E	For tank temp. (5m)	10 ³⁾
	PAC-TH011TKL-E	For tank temp. (30m)	10 ³⁾
	PAC-TH011HT-E	For boiler (flow and return temp.)	20 ²⁾
2 zone kit	PAC-TZ01-E	2 zone kit	1
		Flexible hose	2
		Conversion joint	2
		Gasket	4

Notes: 1) One carton contains 10 PC boards.

2) Two thermistors per package; 10 packages per carton

3) One thermistors per package; 10 packages per carton

Split model

<Indoor unit (Cylinder unit)>

Parts name	Model name	Specification	Cylinder unit										
			EHST20C-VM2C	EHST20C-VM6C	EHST20C-YM9C	EHST20C-TM9C	EHST20C-VM2EC	EHST20C-VM6EC	EHST20C-YM9EC	EHST20C-MEC	EHST20D-VM2C	EHST20D-YM9C	
Wireless remote controller	PAR-WT50R-E		✓	✓	✓	✓	✓	✓	✓	✓	✓	✓	✓
Wireless receiver	PAR-WR51R-E		✓	✓	✓	✓	✓	✓	✓	✓	✓	✓	✓
Thermistors	PAC-SE41TS-E	For room temp.	✓	✓	✓	✓	✓	✓	✓	✓	✓	✓	✓
	PAC-TH011-E	For buffer and zone (flow and return temp.)	✓	✓	✓	✓	✓	✓	✓	✓	✓	✓	✓
	PAC-TH011TK-E	For tank temp.	—	—	—	—	—	—	—	—	—	—	—
	PAC-TH011TKL-E	For tank temp. (longer)	—	—	—	—	—	—	—	—	—	—	—
	PAC-TH011HT-E	For boiler (flow and return temp.)	✓	✓	✓	✓	✓	✓	✓	✓	✓	✓	✓
Immersion heater	PAC-I03V2-E	1Ph 3kW	✓	✓	✓	✓	✓	✓	✓	✓	✓	✓	
EHPT accessories for UK	PAC-WK01UK-E		—	—	—	—	—	—	—	—	—	—	
Wi-Fi interface	PAC-WF010-E		✓	✓	✓	✓	✓	✓	✓	✓	✓	✓	
Drain pan stand	PAC-DP01-E	D665mm H270mm W595mm N/W: 14.5kg	—	—	—	—	—	—	—	—	—	—	
Joint pipe	PAC-SG74RJ-E	For PUHZ-SW75 φ12.7→φ15.88	—	—	—	—	—	—	—	—	✓	✓	
	PAC-SG72RJ-E	For PUHZ-SW75 φ6.35→φ9.52	—	—	—	—	—	—	—	—	✓	✓	
2 zone kit	PAC-TZ01-E	D383 mm H265 mm W356 mm N/W18 kg	✓	✓	✓	✓	✓	✓	✓	✓	✓	✓	

Optional parts

Parts name	Model name	Specification	Cylinder unit									
			EHST20D-VM2EC	EHST20D-MHC	EHST20D-MEC	EHST20D-MHCW	EHST20D-MHCW	ERST20C-VM2C	ERST20C-MEC	ERST20D-VM2C	ERST20D-MEC	
Wireless remote controller	PAR-WT50R-E		✓	✓	✓	✓	✓	✓	✓	✓	✓	✓
Wireless receiver	PAR-WR51R-E		✓	✓	✓	✓	✓	✓	✓	✓	✓	✓
Thermistors	PAC-SE41TS-E	For room temp.	✓	✓	✓	✓	✓	✓	✓	✓	✓	✓
	PAC-TH011-E	For buffer and zone (flow and return temp.)	✓	✓	✓	✓	✓	✓	✓	✓	✓	✓
	PAC-TH011TK-E	For tank temp.	—	—	—	—	—	—	—	—	—	—
	PAC-TH011TKL-E	For tank temp. (longer)	—	—	—	—	—	—	—	—	—	—
	PAC-TH011HT-E	For boiler (flow and return temp.)	✓	✓	✓	✓	✓	✓	✓	✓	✓	✓
Immersion heater	PAC-I03V2-E	1Ph 3kW	✓	—	✓	—	—	✓	✓	✓	✓	
EHPT accessories for UK	PAC-WK01UK-E		—	—	—	✓	✓	—	—	—	—	
Wi-Fi interface	PAC-WF010-E		✓	✓	✓	✓	✓	✓	✓	✓	✓	
Drain pan stand	PAC-DP01-E	D665mm H270mm W595mm N/W: 14.5kg	—	—	—	—	—	✓ ¹⁾	✓ ¹⁾	✓ ¹⁾	✓ ¹⁾	
Joint pipe	PAC-SG74RJ-E	For PUHZ-SW75 φ12.7→φ15.88	✓	✓	✓	—	✓	—	—	✓	✓	
	PAC-SG72RJ-E	For PUHZ-SW75 φ6.35→φ9.52	✓	✓	✓	—	✓	—	—	✓	✓	
2 zone kit	PAC-TZ01-E	D383 mm H265 mm W356 mm N/W18 kg	✓	✓	✓	✓	✓	✓	✓	✓	✓	

Note: PAC-DP01-E is necessary when you use ERST units. If you use ERST units without this parts, drain will be flowed from the base of units, in cooling mode.

1 Optional parts list

Optional parts

<Indoor unit (Hydrobox)>

Parts name	Model name	Specification	Hydro box										
			EHSD-MEC	EHSD-MC	EHSD-VM2C	EHSD-YM9C	EHSC-MEC	EHSC-VM2C	EHSC-VM2EC	EHSC-VM6C	EHSC-VM6EC	EHSC-YM9C	
Wireless remote controller	PAR-WT50R-E		✓	✓	✓	✓	✓	✓	✓	✓	✓	✓	✓
Wireless receiver	PAR-WR51R-E		✓	✓	✓	✓	✓	✓	✓	✓	✓	✓	✓
Thermistors	PAC-SE41TS-E	For room temp.	✓	✓	✓	✓	✓	✓	✓	✓	✓	✓	✓
	PAC-TH011-E	For buffer and zone (flow and return temp.)	✓	✓	✓	✓	✓	✓	✓	✓	✓	✓	✓
	PAC-TH011TK-E	For tank temp.	✓	✓	✓	✓	✓	✓	✓	✓	✓	✓	✓
	PAC-TH011TKL-E	For tank temp. (longer)	✓	✓	✓	✓	✓	✓	✓	✓	✓	✓	✓
	PAC-TH011HT-E	For boiler (flow and return temp.)	✓	✓	✓	✓	✓	✓	✓	✓	✓	✓	✓
Joint pipe	PAC-SG73RJ-E	For PUAZ-SW200YKA/SHW230YKA2(-BS) ϕ 9.52→ ϕ 12.7	—	—	—	—	—	—	—	—	—	—	—
	PAC-SG74RJ-E	For PUAZ-SW75 ϕ 12.7→ ϕ 15.88	✓	✓	✓	✓	—	—	—	—	—	—	—
	PAC-SG72RJ-E	For PUAZ-SW75 ϕ 6.35→ ϕ 9.52	✓	✓	✓	✓	—	—	—	—	—	—	—
Wi-Fi interface	PAC-WF010-E		✓	✓	✓	✓	✓	✓	✓	✓	✓	✓	✓
2 zone kit	PAC-TZ01-E	D383 mm H265 mm W356 mm N/W18 kg	✓	✓	✓	✓	✓	✓	✓	✓	✓	✓	✓

Parts name	Model name	Specification	Hydro box										
			EHSC-YM9EC	EHSC-TM9C	EHSE-YM9EC	EHSE-MEC	ERSD-VM2C	ERSC-MEC	ERSC-VM2C	ERSE-YM9EC	ERSE-MEC		
Wireless remote controller	PAR-WT50R-E		✓	✓	✓	✓	✓	✓	✓	✓	✓	✓	✓
Wireless receiver	PAR-WR51R-E		✓	✓	✓	✓	✓	✓	✓	✓	✓	✓	✓
Thermistors	PAC-SE41TS-E	For room temp.	✓	✓	✓	✓	✓	✓	✓	✓	✓	✓	✓
	PAC-TH011-E	For buffer and zone (flow and return temp.)	✓	✓	✓	✓	✓	✓	✓	✓	✓	✓	✓
	PAC-TH011TK-E	For tank temp.	✓	✓	✓	✓	✓	✓	✓	✓	✓	✓	✓
	PAC-TH011TKL-E	For tank temp. (longer)	✓	✓	✓	✓	✓	✓	✓	✓	✓	✓	✓
	PAC-TH011HT-E	For boiler (flow and return temp.)	✓	✓	✓	✓	✓	✓	✓	✓	✓	✓	✓
Joint pipe	PAC-SG73RJ-E	For PUAZ-SW200YKA/SHW230YKA2(-BS) ϕ 9.52→ ϕ 12.7	—	—	✓	✓	—	—	—	✓	✓	—	—
	PAC-SG74RJ-E	For PUAZ-SW75 ϕ 12.7→ ϕ 15.88	—	—	—	—	✓	—	—	—	—	—	—
	PAC-SG72RJ-E	For PUAZ-SW75 ϕ 6.35→ ϕ 9.52	—	—	—	—	✓	—	—	—	—	—	—
Wi-Fi interface	PAC-WF010-E		✓	✓	✓	✓	✓	✓	✓	✓	✓	✓	✓
2 zone kit	PAC-TZ01-E	D383 mm H265 mm W356 mm N/W18 kg	✓	✓	—	—	✓	✓	✓	✓	—	—	—

Optional parts

<Outdoor unit>

Parts name	Model name	Eco Inverter	Power Inverter								
			SUHZ-SW 45VA(H)	PUHZ-SW 50VKA(-BS)	PUHZ-SW 75VHA(-BS)	PUHZ-SW 100V/YHA(-BS)	PUHZ-SW 120V/YHA(-BS)	PUHZ-SW 160YKA(-BS)	PUHZ-SW 200YKA(-BS)	PUHZ-SW 75V/YAA(-BS)	PUHZ-SW 100V/YAA(-BA)
Connector for Drain Hose Heater Signal Output	PAC-SE60RA-E	—	—	✓	✓	✓	✓	✓	✓	✓	✓
	PAC-SE61RA-E	—	✓	—	—	—	—	—	—	—	—
Air discharge Guide	MAC-886SG-E	✓	—	—	—	—	—	—	—	—	—
	PAC-SJ07SG-E	—	✓	—	—	—	—	—	—	—	—
	PAC-SG59SG-E	—	—	✓	✓	✓	—	—	—	—	—
	PAC-SH96SG-E	—	—	—	—	—	✓	✓	*1	*1	—
Air Protection Guide	PAC-SJ06AG-E	—	✓	—	—	—	—	—	—	—	—
	PAC-SH63AG-E	—	—	✓	✓	✓	—	—	—	—	—
	PAC-SH95AG-E	—	—	—	—	—	✓	✓	*1	*1	—
Drain Socket	PAC-SG61DS-E	—	—	✓	✓	✓	✓	✓	✓	✓	✓
	PAC-SJ08DS-E	—	✓	—	—	—	—	—	—	—	—
Centralized Drain Pan	PAC-SG63DP-E	—	✓	—	—	—	—	—	—	—	—
	PAC-SG64DP-E	—	—	✓	✓	✓	—	—	—	—	—
	PAC-SH97DP-E	—	—	—	—	—	✓	✓	—	—	—
	PAC-SJ83DP-E	—	—	—	—	—	—	—	✓	✓	—
Control/Service Tool	PAC-SK52ST	—	✓	✓	✓	✓	✓	✓	✓	✓	✓
Snow hood	PAC-SNH11HF-E	—	—	✓	—	—	—	—	—	—	—
	PAC-SNH11HS-E	—	—	✓	—	—	—	—	—	—	—
	PAC-SNH11HB-E	—	—	✓	—	—	—	—	—	—	—
	PAC-SNH11HF-E (×2)	—	—	—	✓	✓	—	—	—	—	—
	PAC-SNH21HS-E	—	—	—	✓	✓	—	—	—	—	—
	PAC-SNH21HB-E	—	—	—	✓	✓	—	—	—	—	—

Optional parts

Parts name	Model name	ZUBADAN						Inverter Multi		
		PUHZ-SHW 80VHA	PUHZ-SHW 112V/YHA	PUHZ-SHW 140YHA	PUHZ-SHW 230YKA2	PUHZ-SHW 80V/YAA(-BS)	PUHZ-SHW 112V/YAA(-BS)	PUMY-P112 V/YKM(E)4(-BS)	PUMY-P125 V/YKM(E)4(-BS)	PUMY-P140 V/YKM(E)4(-BS)
Connector for Drain Hose Heater Signal Output	PAC-SE60RA-E	✓	✓	✓	✓	✓	✓	—	—	—
	PAC-SE61RA-E	—	—	—	—	—	—	—	—	—
Air discharge Guide	MAC-886SG-E	—	—	—	—	—	—	—	—	—
	PAC-SJ07SG-E	—	—	—	—	—	—	—	—	—
	PAC-SG59SG-E	✓	✓	✓	—	—	—	—	—	—
	PAC-SH96SG-E	—	—	—	✓	*1	*1	✓	✓	✓
Air Protection Guide	PAC-SJ06AG-E	—	—	—	—	—	—	—	—	—
	PAC-SH63AG-E	✓	✓	✓	—	—	—	—	—	—
	PAC-SH95AG-E	—	—	—	✓	*1	*1	✓	✓	✓
Drain Socket	PAC-SG61DS-E	—	—	—	—	—	—	✓	✓	✓
	PAC-SJ08DS-E	—	—	—	—	—	—	—	—	—
Centralized Drain Pan	PAC-SG63DP-E	—	—	—	—	—	—	—	—	—
	PAC-SG64DP-E	—	—	—	—	—	—	—	—	—
	PAC-SH97DP-E	—	—	—	—	—	—	✓	✓	✓
	PAC-SJ83DP-E	—	—	—	—	—	—	—	—	—
Control/Service Tool	PAC-SK52ST	✓	✓	✓	✓	✓	✓	—	—	—
Snow hood	PAC-SNH11HF-E	—	—	—	—	—	—	—	—	—
	PAC-SNH11HS-E	—	—	—	—	—	—	—	—	—
	PAC-SNH11HB-E	—	—	—	—	—	—	—	—	—
	PAC-SNH11HF-E (×2)	✓	✓	✓	—	—	—	—	—	—
	PAC-SNH21HS-E	✓	✓	✓	—	—	—	—	—	—
	PAC-SNH21HB-E	✓	✓	✓	—	—	—	—	—	—

*1 This model requires PAC-SJ82AT for attachment.

<Interface/Flow temperature control>

Parts name	Model name	Specification	Eco Inverter	Power Inverter						
			SUHZ-SW45VA(H)	PUHZ-SW50 VKA(-BS)	PUHZ-SW75 VHA(-BS)	PUHZ-SW 100V/YHA(-BS)	PUHZ-SW 120V/YHA(-BS)	PUHZ-SW 160YKA(-BS)	PUHZ-SW 200YKA(-BS)	
Capacity step control interface	PAC-IF011B-E	1 PC Board w/ Case	—	✓	✓	✓	✓	✓	✓	✓
Flow Temperature Controller	PAC-IF032B-E	1 PC Board w/ Case	—	✓	✓	✓	✓	✓	✓	✓
System controllers	PAC-IF061B-E	1 PC Board w/ Case	✓	✓	✓	✓	✓	✓	✓	✓
	PAC-IF062B-E	1 PC Board w/ Case	✓	✓	✓	✓	✓	✓	✓	✓
	PAC-IF063B-E	1 PC Board w/ Case	✓	✓	✓	✓	✓	✓	✓	✓
	PAC-SIF051B-E	1 PC Board w/ Case	—	✓	✓	✓	✓	✓	✓	✓
Thermistor	PAC-TH011-E		✓	✓	✓	✓	✓	✓	✓	✓

Parts name	Model name	Specification	Power Inverter		ZUBADAN						
			PUHZ-SW 75V/YAA(-BS)	PUHZ-SW 100V/YAA(-BS)	PUHZ-SHW 80VHA	PUHZ-SHW 112V/YHA	PUHZ-SHW 140YHA	PUHZ-SHW 230YKA2	PUHZ-SHW 80V/YAA(-BS)	PUHZ-SHW 112V/YAA(-BS)	
Capacity step control interface	PAC-IF011B-E	1 PC Board w/ Case	✓	✓	✓	✓	✓	✓	✓	✓	✓
Flow Temperature Controller	PAC-IF032B-E	1 PC Board w/ Case	✓	✓	✓	✓	✓	✓	✓	✓	✓
System controllers	PAC-IF061B-E	1 PC Board w/ Case	✓	✓	✓	✓	✓	✓	✓	✓	✓
	PAC-IF062B-E	1 PC Board w/ Case	✓	✓	✓	✓	✓	✓	✓	✓	✓
	PAC-IF063B-E	1 PC Board w/ Case	✓	✓	✓	✓	✓	✓	✓	✓	✓
	PAC-SIF051B-E	1 PC Board w/ Case	✓	✓	✓	✓	✓	✓	✓	✓	✓
Thermistor	PAC-TH011-E		✓	✓	✓	✓	✓	✓	✓	✓	✓

CONTENTS

Parts name	Model name	Contents	Q'ty
Air discharge guide	MAC-886SG-E	Air discharge guide	1
		Screw	4
	PAC-SJ07SG-E	Air discharge guide	1
		Support (For right and left)	2
		Attachment screw(5×10)	4
		Attachment screw(4×10)	4
	PAC-SG59SG-E	Air discharge guide	1
		Attachment screw(5×35)	4
		Spacer	4
	PAC-SG96SG-E	Air discharge guide	1
		Support	1
		Screw(5×15)	12
Washer		12	
Spring washer		12	
Air protection guide	PAC-SJ06AG-E	Air protect guide	1
		Mounting screw (4×16)	4
		Washer (for screw 4×16)	4
		Spring washer	4
	PAC-SH63AG-E	Air guide	1
		Mounting screw (5×15)	4
		Washer	4
		Spring washer	4
	PAC-SH95AG-E	Air guide	1
		Mounting screw (5×15)	6
		Washer	6
		Spring washer	6
Drain socket	PAC-SG61DS-E	Drain socket	1
		Drain cap (φ33)	5
		Heat insulator	3
		Band	8
Centralized drain pan	PAC-SJ08DS-E	Drain socket	1
	PAC-SG63DP-E	Centralized drain pan	1
	PAC-SG64DP-E	Centralized drain pan	1
	PAC-SH97DP-E	Centralized drain pan	1
Control/Service tool	PAC-SK52ST	Control/Service Tool	1
Capacity step control interface	PAC-IF011B-E	PC Board	1
		Case	1
		Thermistor	2
Flow temperature controller	PAC-IF032B-E	PC Board	1
		Case	1
		Thermistor	3
		Remote controller	1
		Remote controller cable (5m)	1
System controllers	PAC-IF061B-E	PC Board	1
		Case	1
		Thermistor	1
		Flow/Return water temp. thermistor	1
		Remote controller	1
		Remote controller cable (10m)	1
		SD memory card	1
		PAC-IF062B-E	PC Board
	Case	1	
	Flow/Return water temp. thermistor	1	
	Remote controller	1	
	Remote controller cable (10m)	1	
	SD memory card	1	
	PAC-IF063B-E	PC Board	1
		Case	1
		Tank thermistor	1
Flow/Return water temp. thermistor		1	
Remote controller		1	
Remote controller cable (10m)		1	
PAC-SIF051B-E	PC Board	1	
	Case	1	
	Thermistor	1	
	Flow/Return water temp thermistor	1	
	Remote controller cable (10m)	1	
	SD memory card	1	
Thermistors	PAC-TH011-E	For buffer and zone (flow and return temp.)	20 ¹⁾
	PAC-TH011TK-E	For tank temp. (5m)	10 ²⁾
	PAC-TH011TKL-E	For tank temp. (30m)	10 ²⁾
	PAC-TH011HT-E	For boiler (flow and return temp.)	20 ¹⁾
Drain pan stand	PAC-DP01-E	Drain pan stand (for ERST)	1
2 zone kit	PAC-TZ01-E	2 zone kit	1
		Flexible hose	2
		Conversion joint	2
		Gasket	4

Notes:

- 1) Two thermistors per package; 10 packages per carton
- 2) One thermistors per package; 10 packages per carton



ecodan

Wireless Remote Controller and Receiver

PAR-WT50R-E

PAR-WR51R-E

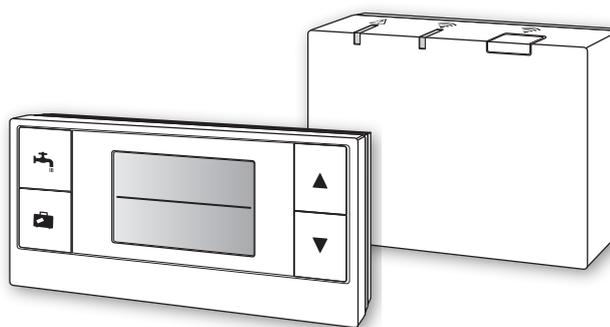

This manual explains installation of the PAR-WR51R-E wireless receiver and the PAR-WT50R-E wireless remote controller, and settings of these devices. Before installing the devices, read this manual thoroughly. After reading, be sure to hand this manual to the user.

1. Safety Precautions

- The precautions mentioned below are important to use the device safely. Be sure to understand and follow them.
- The following hazardous classification shows the likelihood and severity of hazards if a person does not follow the instructions contained on the following signs.

Warning	Indicates a hazardous situation which, if a person does not follow the instructions, could result in death or serious injury.
Caution	Indicates a potentially hazardous situation that, if a person does not follow the instructions, may result in bodily injury or property damage.

Warning	
► Installation	
Do not use the device in particular environments.	Do not use the device in particular environments where the following substances are present in large amounts: oil, vapour, organic solvent, corrosive gas (such as ammonia, sulphuric compounds, and acid or the like), or where acid or alkali solution, or particular sprays are used frequently. This could affect operating performance, or cause corrosion, which could result in electrical shock, breakdown, smoke generation, or fire.
Do not place the devices in an environment where flammable gas may occur, stay, flow in, or leak.	Build-up of flammable gas could result in fire or explosion.
The device must be installed by a dealer or an authorised technician according to the appropriate installation manual.	If the device is installed improperly, electric shock or fire could result.
Do not place the device in an environment that exposes it to large amounts of vapor or condensation.	Electric shock, fire, or breakdown could result.
► Wiring	
The wireless receiver's maximum voltage is 12V DC. Do not connect 230V AC power source to the wireless receiver.	Breakdown, ignition, or fire could result.
Connections must be made securely and without tension or external force on the terminals.	If connections are made improperly, breaking of wire, heat generation, or fire could result.
► Others	
Do not use sharp objects to press the buttons.	Electric shock or breakdown may result.
Do not touch or operate the device with wet hands.	Electric shock or breakdown may result.
Do not wash the device with water or solution or the like.	Electric shock or breakdown may result.
When installing or repairing the device, ask a dealer or a qualified technician.	If the device is not installed properly, electric shock, smoke generation, or fire could result from entry of dust or water.
Do not disassemble or modify.	

Optional parts

⚠ Caution

Do not drop the device.	This could break the case or affect the device enough to make it inoperable.
Install the device in a place capable of bearing its own weight .	If the device is not installed securely or properly, the wireless receiver may fall.

■ Disposal

This symbol mark is for EU countries only.

This symbol mark is according to the directive 2002/96/EC Article 10 Information for users and Annex IV, and/or to the directive 2006/66/EC Article 20 Information for end-users and Annex II.



Your MITSUBISHI ELECTRIC product is designed and manufactured with high quality materials and components which can be recycled and/or reused. This symbol means that electrical and electronic equipment, batteries and accumulators, at their end-of-life, should be disposed of separately from your household waste. If a chemical symbol is printed beneath the symbol, this chemical symbol means that the battery or accumulator contains a heavy metal at a certain concentration.

This will be indicated as follows: Hg: mercury (0.0005%), Cd: cadmium (0.002 %), Pb: lead (0.004%)

In the European Union there are separate collection systems for used electrical and electronic products, batteries and accumulators.

Please, dispose of this equipment, batteries and accumulators correctly at your local community waste collection/recycling centre.

Please, help us to conserve the environment we live in!

2. Accessories and Installation Tool

The following items are included in the box.

Part name	No.
① Wireless receiver <PAR-WR51R-E> (2 m long cable included)	1
② Bracket	1
③ Flat head screw (4.1 × 6)	4
④ Installation and setting manual	1

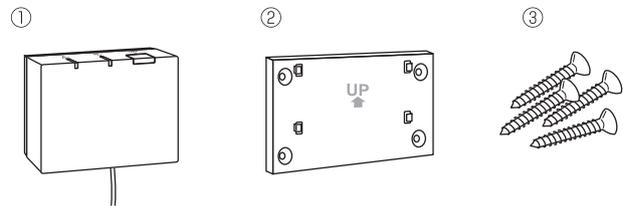

* Installing of the devices requires a Phillips-head screwdriver (No.2 6 mm).

3. Before using ATW wireless system

Following is the summary of the procedure for installing and setting the wireless system.

1. Devices and manuals required to set and install the wireless system

- ① PAR-WT50R-E wireless remote controller
- ② PAR-WR51R-E wireless receiver
- ③ ATW wireless system installation and setting manual (this manual)
- ④ Wireless remote controller operation manual (hereinafter abbreviated as OM)
- ⑤ Ecodan system installation manual (hereinafter abbreviated as IM)

2. Installing and setting procedure

- ① Power off the ecodan system.
- ② Install the wireless receiver on the ecodan system.
(See "4. Installing the Wireless Receiver" in this manual.)

When installing the wireless receiver, be sure to set the SW1-8 on the control board to ON. (See "5.1 DIP Switch Functions" in IM.)

- ③ Power on the ecodan system, and the LEDs will blink on the receiver for 3 seconds.
- ④ Place two AA alkaline batteries in the wireless remote controller.
(See "Batteries" in "4. Before Operation" in OM.)
- ⑤ Perform pairing process between the wireless receiver and the remote controller.
(See "5. Pairing process" in this manual.)

The wireless receiver does not go through a pairing process unless the ecodan system is off. When the system is ON, be sure to turn it off before beginning the pairing process.

- ⑥ Test wireless communication between the wireless remote controller and the wireless receiver.
(See "6.4 Communication Test" in "6. Setting wireless remote controllers" in this manual.)
- ⑦ Position the wireless remote controller in an appropriate place.
(See "4. Before Operation" in OM.)
- ⑧ To set the wireless remote controller as a room sensor that monitors room temperature, see "Main remote controller Options" in IM.

- ⑨ Use the main controller to set the ecodan system to the room temp. (🏠) mode.
 When the flow temp. (💧) mode or the compensation curve (📈) mode is selected, the wireless remote controller will operate as a thermostat. (See "Main remote controller" in IM.)

When the remote controller set as a room sensor runs out of battery or gets a communication error during room temp. mode, the room temp. mode will automatically switch to the compensation curve mode. The room temp. mode will be restored by battery replacement or solution of communication error.

Installation and setting of the wireless remote controller is complete. To set additional wireless remote controllers, repeat Step ④ to ⑦.

4. Installing Wireless Receiver

4.1 Connecting to Cylinder unit

* Before installation, be sure to turn off the main power supply.

- ① Remove the two screws that hold the front panel, and remove the panel.

If the removed front panel is set aside away from the indoor unit, ensure the relay connector on Main remote controller is disconnected.

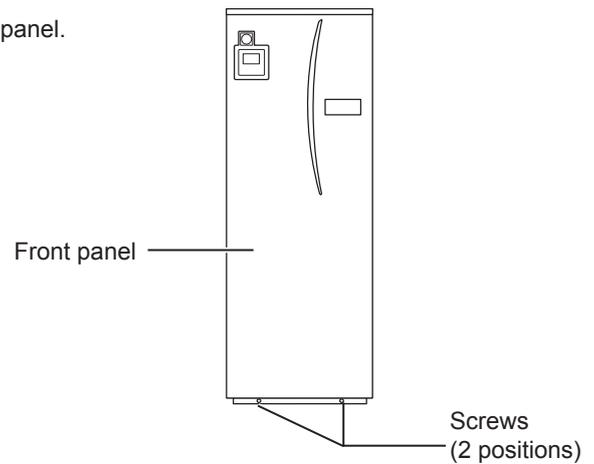

- ② Remove the screw and pull the control and electrical box so that the control and electrical box is swung toward you from left.

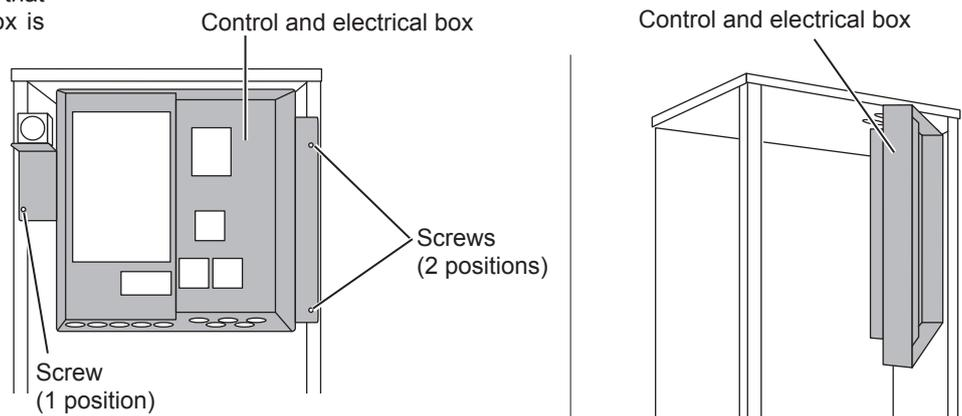

- ③ Run the receiver's cable into the cylinder unit through the inlet as shown on the figure.

Do not run the receiver's cable through an inlet that a power cable goes through and do not bundle the cable together with a power cable.

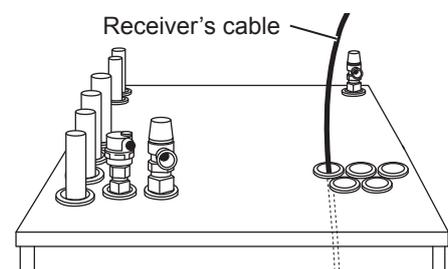

- ④ Route the cable out the back of the control and electrical box, and run the cable into the box through the shown inlet in the underside of the box.

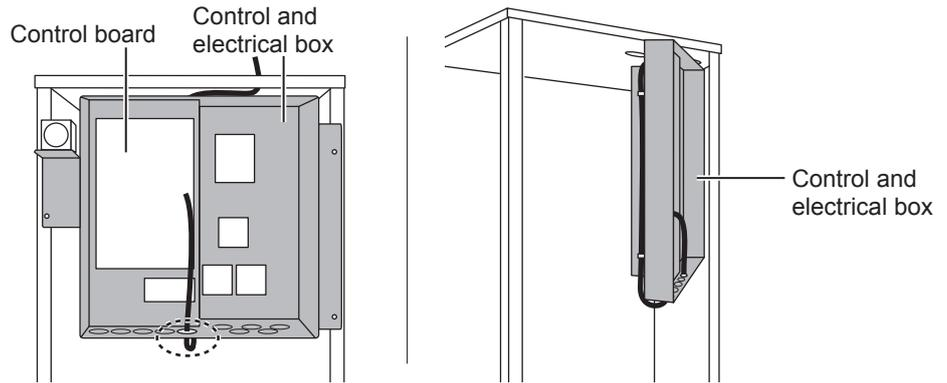

- ⑤ Connect the cable connector to the CNRF terminal on the control board. Switch ON SW1-8.

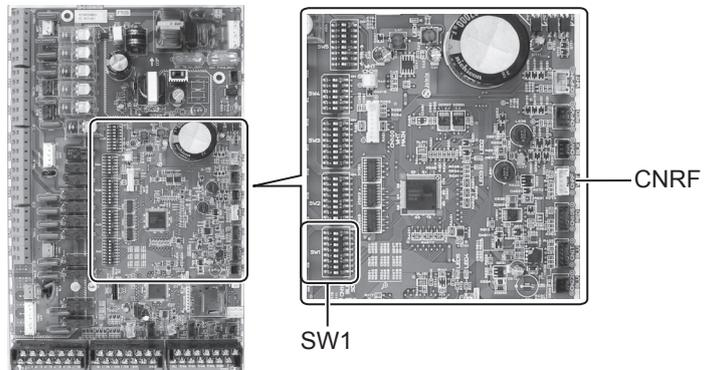

- ⑥ Remove excessive slack on the cable, then secure the cable with a cable fastener and 2 cable straps on the upper side and center on the back of control and electrical box.

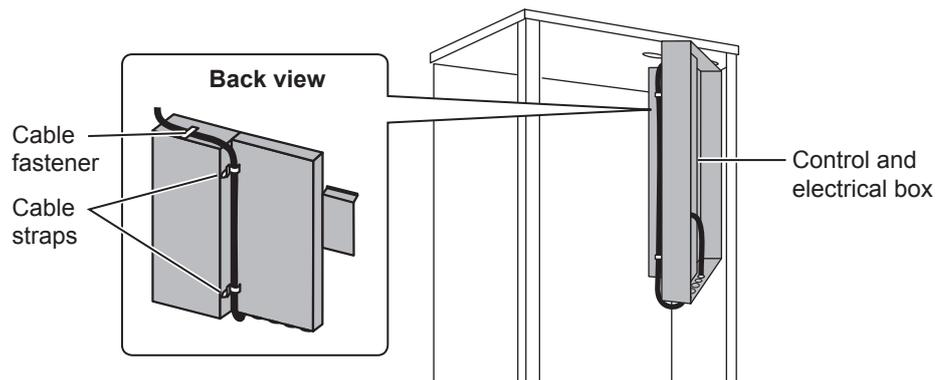

- ⑦ Place the control and electrical box back in the original position and reinstall the 3 screws.

- ⑧ Check the maximum reach of the cable and install the bracket on the wall with screws.

Do not excessively pull the cable when checking the maximum reach.

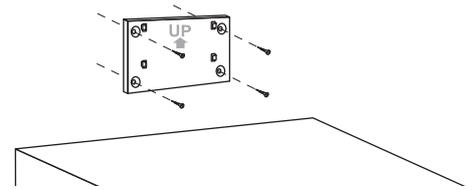

<Notice>

- **Do not overtighten the screws.**
 - ▶ The bracket may deform or break.
- **When installing the bracket, select an interference-free space.**
 - ▶ Keep the installing area at least 10 cm away from metal or a wall box. If unable to do so, always place the room wireless remote controllers in locations where the communication test determines that the wireless remote controllers are fully capable of communication with the wireless receiver.
- **Do not install the bracket with screws on the exterior casing of the cylinder unit.**
 - ▶ The internal parts may be damaged, which could result in breakdown of the indoor unit.
- **Do not install the bracket where the receiver could be exposed to moisture or leaked water from piping connections above.**
 - ▶ The wireless receiver subjected to moisture or leaked water could cause electric shock, fire, or its breakdown.

- ⑨ Place the wireless receiver on the fixed bracket.
Hook the holes on the back of the wireless receiver onto the projections on the bracket, and fix the wireless receiver in place.

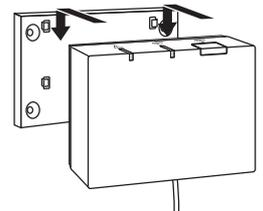

<Notice>

- **Do not place the wireless receiver inside the cylinder unit.**
 - ▶ Both the wireless receiver and its wire may break due to heat inside the indoor unit.
- **Do not let the wireless receiver stand on top of the cylinder unit. Always fix the wireless receiver onto the bracket.**
 - ▶ Wireless communication performance may be affected.
- **Do not pull the cable excessively.**
 - ▶ Breakdown, ignition, or fire may result.
- **Do not have the wireless receiver suspended.**
 - ▶ Breakdown, ignition, or fire may result.

- ⑩ Fix the front panel with screws.

4.2 Connecting to Hydrobox

* Before installation, be sure to turn off the main power supply.

① Remove the two screws that hold the front panel, and remove the panel.

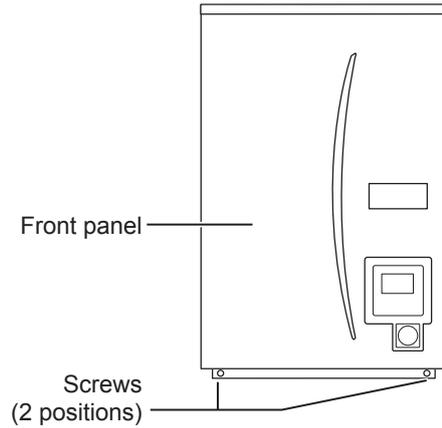

② Route the receiver's cable into the hydrobox through the leftmost inlet at the bottom of the unit. Then route into the control and electrical box through the shown inlet at the bottom of the control and electrical box.

- Do not bundle the receiver cable with a power cable.
- Do not run the cable through an inlet that a power cable goes through.

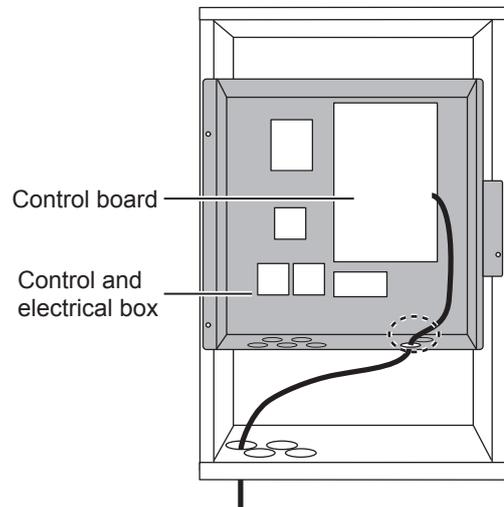

③ Connect the cable connector to CNRF on the control board. Switch ON SW1-8.

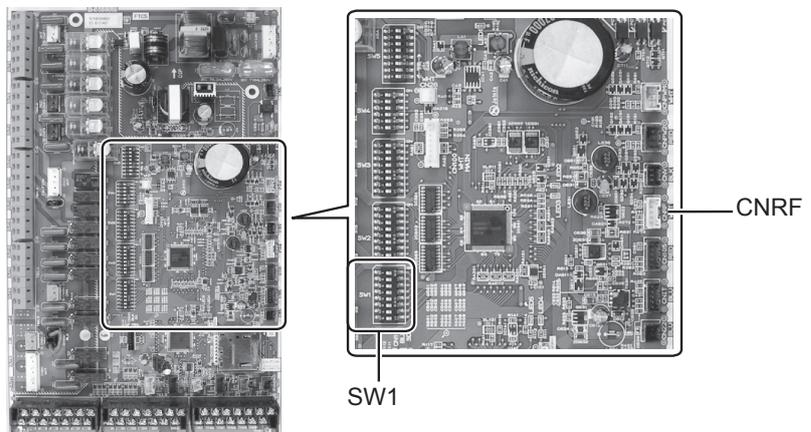

Optional parts

- ④ Check the maximum reach of the cable and install the bracket with screws.

Do not excessively pull the cable when measuring the maximum reach.

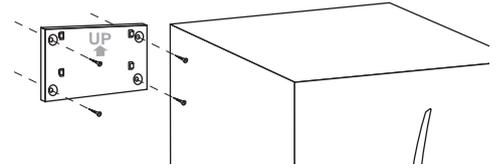

<Notice>

- **Do not overtighten the screws.**
 - ▶ The bracket may deform or break.
- **When installing the bracket, select an interference-free space.**
 - ▶ Keep the installing area at least 10 cm away from metal or a wall box. If unable to do so, always place the room wireless remote controllers in locations where the communication test determines that the wireless remote controllers are fully capable of communication with the wireless receiver.
- **Do not install the bracket with screws on the exterior casing of the cylinder unit.**
 - ▶ The internal parts may be damaged, which could result in breakdown of the indoor unit.
- **Do not install the bracket where the receiver could be exposed to moisture or leaked water from piping connections above.**
 - ▶ The wireless receiver subjected to moisture could cause electric shock, fire, or its breakdown.

When installing the wireless receiver, observe the following.

- Keep the other electric or electronic devices (e.g. radio, induction heating cooker, microwave oven, refrigerator, and mobile phone or the like) at least 50 cm away from the wireless receiver.
- Place the wireless receiver in an interference-free area and keep the wireless receiver away from metal.

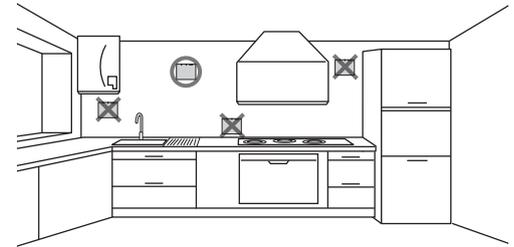

- ⑤ Place the wireless receiver on the fixed bracket. Hook the holes on the back of the wireless receiver onto the projections on the bracket, and fix the wireless receiver.

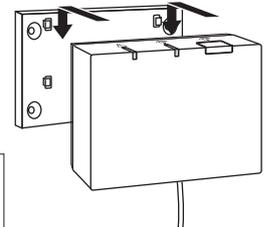

<Notice>

- **Do not place the wireless receiver inside the hydrobox.**
 - ▶ Both the wireless receiver and its wire may break due to heat inside the indoor unit.
- **Do not pull the cable excessively.**
 - ▶ Breakdown, ignition, or fire may result.
- **Do not have the wireless receiver suspended.**
 - ▶ Breakdown, ignition, or fire may result.

- ⑥ Hold the front panel with the screws.

5. Pairing process

- If the wireless remote controller is not paired, the indoor unit cannot be operated using the remote controller.
- Before using the wireless remote controllers, always ensure to go through a pairing process.
- Pairing is NOT possible unless the ecodan system is off. When the ecodan system is ON, be sure to turn it off before starting the pairing process.
- The wireless receiver is also needed for pairing, so please make sure to operate the wireless remote controller near the wireless receiver.

① Hold down  button on the wireless receiver for 3 seconds or more until orange  LED blinks.

The pairing mode is cancelled by pressing  button.

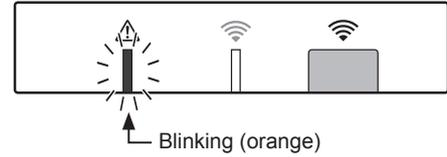

② Hold down ,  and  buttons simultaneously for at

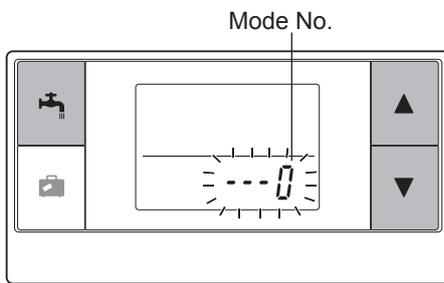

③ Press  or  button to set the mode number to "1" and press  button.

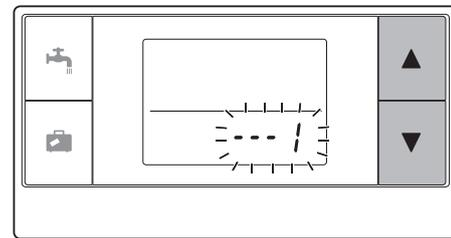

④ When  button is pressed in the middle of setting, the screen returns to the previous indication.

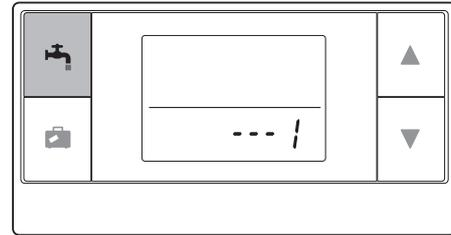

When  appears on the display, do not perform pairing. The power may be turned off in the middle of pairing, which may lose the pairing information.

⑤ Press  or  button to select a pairing address, and press  button to set the address.
" - " (no setting) is displayed initially. Choose a number from 1 to 8.

After pressing  button, the wireless remote controller starts communication with the wireless receiver.

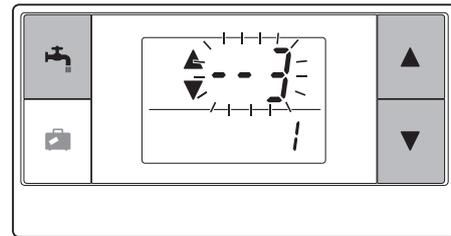

When using multiple wireless remote controllers in one ecodan system, be sure to set different address for each remote controller.

⑥ When the pairing process has been successfully performed, "ok" is shown on the remote controller and green  LED steadily lights on the wireless receiver.

<Pairing is successful>

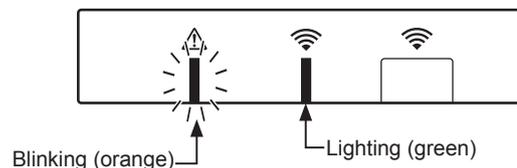
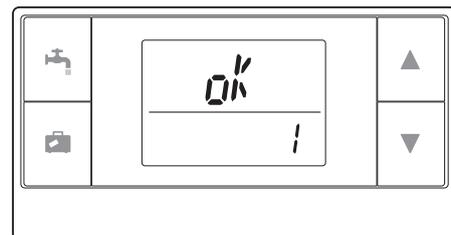

When "Err" appears on the remote controller and green LED on the wireless receiver blinks, correctly repeat the same process from step 5.

Even if the pairing process failed, the wireless receiver stays in the pairing mode for 5 minutes unless cancelled.

<Pairing is unsuccessful>

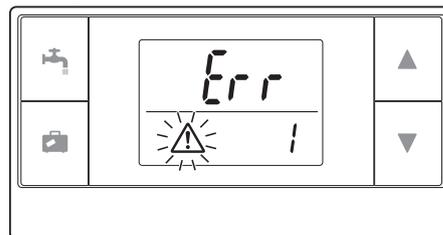

Blinking (orange) Blinking (green)

<<Main causes that prevent successful pairing>>

- **The wireless receiver does not enter the pairing mode.**
 - ▶ Press button for 3 seconds or more until orange LED blinks. Make sure to turn off the ecodan system by main controller.
- **Pairing is attempted outside the transmission range of the wireless receiver.**
 - ▶ Adjust the distance between the wireless receiver and remote controller, and so try again. If the distance is excessively short, pairing may fail. Keep the distance of about 50 cm.
- **The wireless remote controller has been already paired with the wireless receiver.**
 - ▶ The pairing address assigned to a wireless remote controller cannot be changed by remote controller. Use the wireless receiver to reset pairing information. (Refer to "(3) Resetting pairing information" in "7.3. Wireless Receiver Functions".)

Even when power fails or when the batteries run down, the pairing information will be kept.

6. Setting wireless remote controllers

① Hold down , and buttons simultaneously for at least 3 seconds until the mode number blinks.

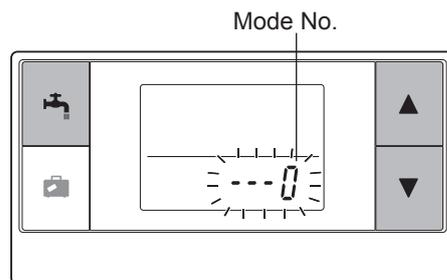

② Press or button to choose a mode number.

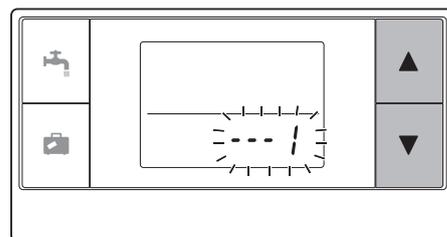

③ Confirm setting by pressing button. The display stops blinking and lights steadily.

When button is pressed in the middle of setting, the screen returns to the previous indication.

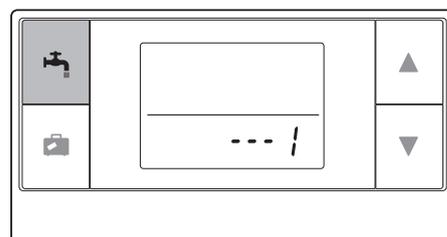

Optional parts

Mode No.	Names	Functions	Initial settings
0	Pairing address display	To view the own pairing address of the wireless remote controller.	
1	Pairing	To perform a pairing process with the wireless receiver.	
2	Temperature unit	To select °C or °F.	°C
3	Communication test	Communication test with the wireless receiver.	
4	Room temperature display	Actual room temperature display	OFF
5	Automatic zone no. display	To enable or disable automatic zone no. display.	OFF

6.1. Viewing Address Number (Mode No. 0)

Set the mode no. to "0".

The display to the right shows that the address is set to "2".

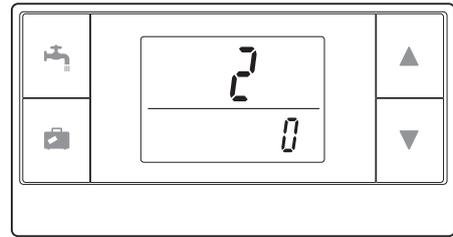

6.2. Pairing (Mode No. 1)

For details, refer to "6. Pairing process".

6.3. Selecting the Temperature Unit (Mode No. 2)

Set the mode no. to "2".

The temperature reading can be selected between Celsius (°C) or Fahrenheit (°F).

Press ▲ or ▼ button to select °C or °F and press ⏏ button to confirm the selection.

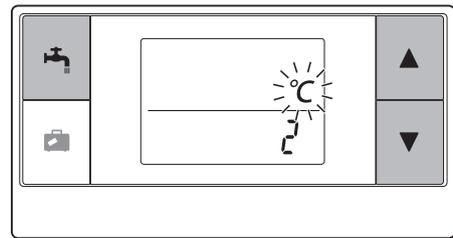

6.4. Communication Test (Mode No. 3)

Set the mode no. to "3".

Communication test is performed between the wireless remote controller and the wireless receiver.

When the display shows "ok", this indicates that the communication between the remote controller and the receiver is established. If "Err" is shown, the wireless remote controller is not communicating with the wireless receiver.

Do not leave the wireless remote controller in a location where the communication test results in "Err".

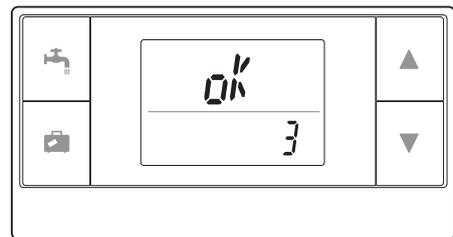

Before conducting the communication test, ensure that the wireless remote controller goes through a pairing process.

6.5. Displaying or Hiding Room Temperature (Mode No. 4)

Set the mode no. to "4".

Select either displaying or hiding the room temperature.

Press ▲ or ▼ button to select displaying or hiding the room temperature, and press ⏏ button to save the setting.

Hiding : " - - - ".

Displaying : Actual room temperature is displayed

<When the actual room temperature is NOT displayed >

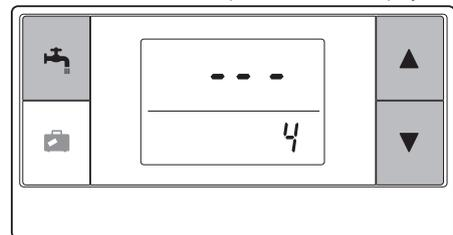

<When the actual room temperature is displayed >

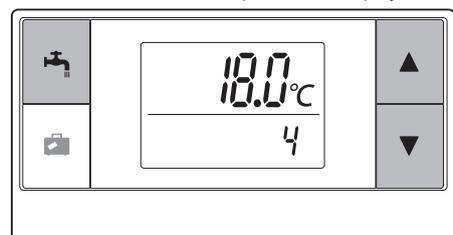

When the indoor unit is operating, the room temperature display shows the actual room temperature (18°C) below and the set temperature (20°C) above as shown in the figure to the right. The measurable temperature range is from 0°C to 40°C.

If the measured room temperature is out of 0°C to 40°C range, the room temperature display blinks.

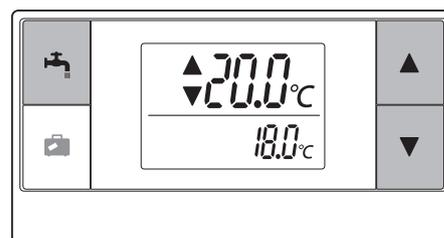

When the wireless remote controller is installed on a bracket, room temperature might not be accurate being affected by the wall temperature. Perform a test run and place the remote controller where the room temperature can be correctly detected.

6.6. Automatic Zone No. Display (Mode No. 5)

Set the mode no. to "5".

When the automatic zone no. display is active, a zone number assigned to the remote controller is displayed for 3 seconds after temperature setting.

Press ▲ or ▼ button to select between " - - - " and Z1 or Z2, and press button to save setting.

Inactive : " - - - ".

Active : The zone no. (Z1 or Z2) assigned to the remote controller is shown.

<Inactive>

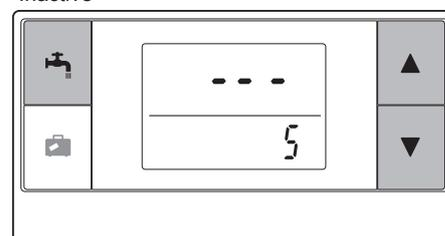

<Active>

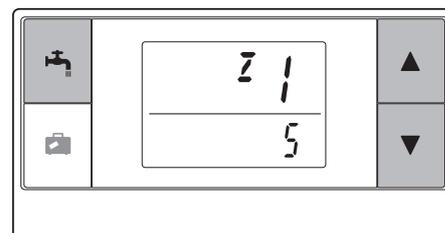

7. Wireless Receiver Operation

The wireless receiver is powered by indoor unit. It communicates with the wireless remote controller(s), and transmits to the indoor unit the operation status and commands received from the wireless remote controller(s). The wireless receiver has two modes available: pairing mode and pairing reset mode.

7.1. Functions of Buttons and Displays

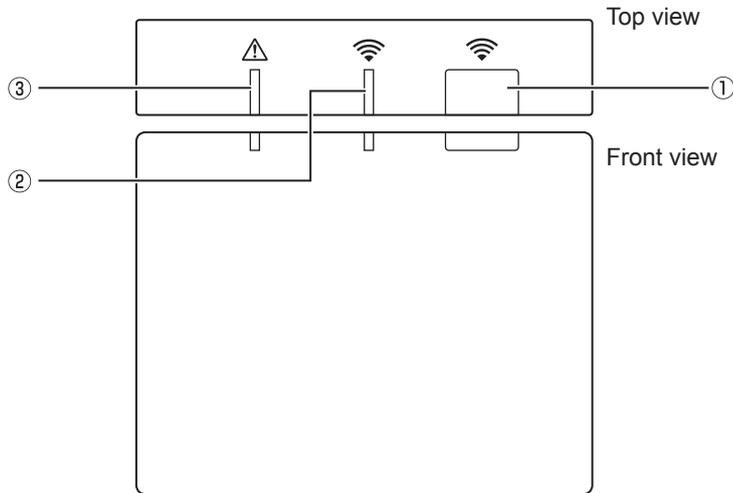

Number	Item	Description
①	Setting button	To switch operating mode.
②	Communication LED (green)	To indicate that the wireless receiver is communicating.
③	Operation LED (orange)	To show operating status of the wireless receiver.

The following table shows the operating and illuminating status of the LEDs.

Operation LED (orange)	Communication LED (green)	Description
Blinking	Blinking	Power is ON (for 3 seconds).
Off	Off	Normal mode: Not paired
Off	On	Normal mode: Paired
Off	Blinking	Normal mode: Communicating
Blinking	Off	Performing a pairing process
Blinking	On	Pairing: Successful
Blinking	Blinking	Pairing: Unsuccessful
On	On	Pairing information is cleared

7.2. Turning on Power

When the wireless receiver is powered by indoor unit after installation, green  LED and orange  LED blink for 3 seconds.

Power ON



7.3. Wireless Receiver Functions

(1) Normal mode

When the wireless receiver is paired with a wireless remote controller, green  LED comes on. When the wireless receiver is communicating with a wireless remote controller, green  LED blinks.

Not paired



Paired



Transmitting



(2) Pairing mode

*For details, refer to "6. Pairing process" in this manual.

(3) Resetting pairing information

Once pairing information has been cleared, ALL the wireless remote controllers need go through a pairing process again.

Hold down  button for 5 seconds or more until  and  LED light while pairing mode is active. All the pairing information is cleared.

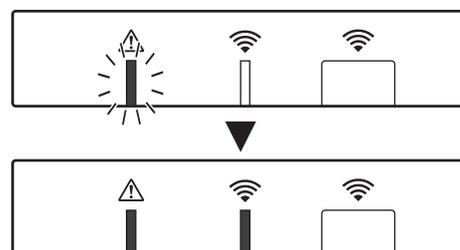

8. Q&A

Questions	Answers
How many wireless remote controllers are allowed to be paired?	Up to 8 controllers.
What should be noted about Pairing?	<ul style="list-style-type: none"> • The same address cannot be assigned to multiple remote controllers • If the same address is assigned to multiple controllers, the address can be assigned to only the last paired remote controller. • Once the remote controller is paired, its pairing address cannot be changed by remote controller. Use the wireless receiver to reset pairing information.
What causes a communication error between the wireless remote controller and wireless receiver?	Check the following possible causes. <ul style="list-style-type: none"> • The batteries on the wireless remote controller are running out. • The transmitted signal does not reach the wireless receiver. • The wireless remote controller is not paired.
What measures should be taken when the room temp. display indicates "1" with  ?	The indoor unit or outdoor unit has a failure. Refer to the indications on the main controller and take appropriate measures. Please also check installation and service manuals for the indoor unit.
What measures should be taken when the room temp. display indicates "2" with  ?	The thermistor inside the wireless remote controller has a failure. Check the resistance of the thermistor. (When the room temperature is between 0 and 40°C, the resistance must be between 5 and 28 kΩ.)
What measures should be taken when the room temp. display indicates "3" with  ?	A communication error occurs between the wireless remote controller and the wireless receiver. Check the following possible causes. <ul style="list-style-type: none"> • The signal that is transmitted by the wireless remote controller does not reach the wireless receiver. • The wireless remote controller is not paired.
What measures should be taken when the room temp. display indicates "4" with  ?	A communication error occurs between the wireless receiver and the indoor unit. Check the following possible causes. <ul style="list-style-type: none"> • The cable connecting between the wireless receiver and the indoor unit has severed. • The wireless receiver is not correctly connected to the indoor unit.
What measures should be taken when the room temp. display indicates "E" with  ?	Backup heater is running due to a failure of the indoor unit or the outdoor unit. Check the error code displayed on the main controller and take appropriate measures accordingly. The holiday mode is NOT available during backup heater only operation.

Optional parts

<<2-zone temperature control>>

- A thermistor is built in the remote controller (Room RC) or the main controller (Main RC), or TH1. The indoor unit refers to temperature monitored by a selected thermistor and controls temperature for each zone.
 - For 2-zone temperature control, one room sensor can be selected for Zone1 and Zone2 separately. The room sensor is used for monitoring room temperature.
 - The selection of room sensor can be fixed or changed according to time, using a schedule timer.
- Note: Room sensor can be selected by main controller only.**

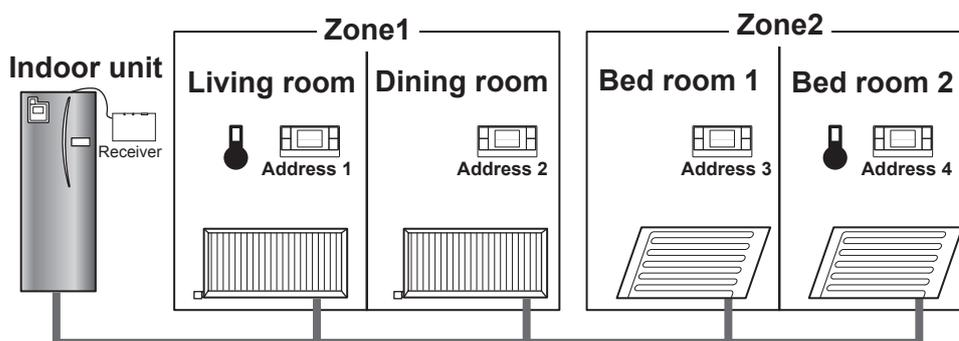

When  is shown on the remote controller, this indicates that the remote controller is used for monitoring the room temperature. In this example, the living room temperature monitored by remote controller 1 is regarded as the room temperature for Zone1. The bed room 2 temperature monitored by remote controller 4 is regarded as the room temperature for Zone2.

9. Specifications

Item	Description
Power source	12V DC (powered by indoor unit)
Operating temperature and humidity requirements	Temperature: 0 to 40°C Humidity 30 to 90%RH (No condensation)
Weight	150 g (excluding a cable)
Dimension (W×H×D)	100 mm × 80 mm × 30 mm

■ Product fiche of temperature control

- (a) Supplier's name: MITSUBISHI ELECTRIC CORPORATION
- (b) Supplier's model identifier: PAR-WT50R-E and PAR-WR51R-E
- (c) The class of the temperature control: VI
- (d) The contribution of the temperature control to seasonal space heating energy efficiency: 4%



CYLINDER UNIT OPTIONAL PARTS

IMMERSION HEATER (1Ph 3kW)

PAC-IH03V2-E

INSTALLATION MANUAL

- Before starting installation, read the following description together with the installation manual included with the cylinder unit.
- Please read carefully and observe fully the following safety precautions.

⚠ WARNING Precaution that must be observed to prevent injuries or death.

- After installation carry out a test run to ensure correct operation, then explain operation method and safety precautions to the end user.
Tell your customers to keep this installation manual together with the operation manual, and when they give or sell this machine to any other person include this installation manual and operation manual with it.

⚠ WARNING

- If the cylinder has already been connected to the power supply ensure circuit breaker is off before carrying out electrical work.
- If the immersion heater is installed incorrectly or modified after installation by the user, water leakage, electric shock or fire may result.
- All electrical work should be performed by a qualified technician according to local regulations and the instructions given in this manual.
- The immersion heater must be powered by a dedicated power supply and the correct voltage and correctly sized circuit breakers must be used.
- Connections must be made securely and without tension on the terminals.
The included component parts of the PAC-IH03V2-E IMMERSION HEATER (1Ph 3kW) shall be used only for the purposes indicated in the installation manual.

Contents

	Item	Piece
①	Immersion heater	1
②	Thermostat (High limit thermal cut-out)	1
③	Tab cover	1
④	Earth leakage breaker	1
⑤	Screw (4×25)	2
⑥	Relay	1
⑦	Screw (4×16)	2
⑧	Label (for Earth leakage breaker)	1
⑨	Label (for Relay)	1
⑩	Lead wire with connector	1
⑪	Lead wire (Red, 130mm)	1
⑫	Lead wire (Blue, 130mm)	1
⑬	Lead wire (Red, 1500mm)	1
⑭	Lead wire (Blue, 1500mm)	1
⑮	Water-proof cover	1
⑯	Water-proof seal (3x35x25)	1
⑰	Water-proof seal (3x40x25)	1
⑱	Band	4
⑲	Tool	1
⑳	Installation manual	1
㉑	Fastener	1
㉒	Spec name plate	1

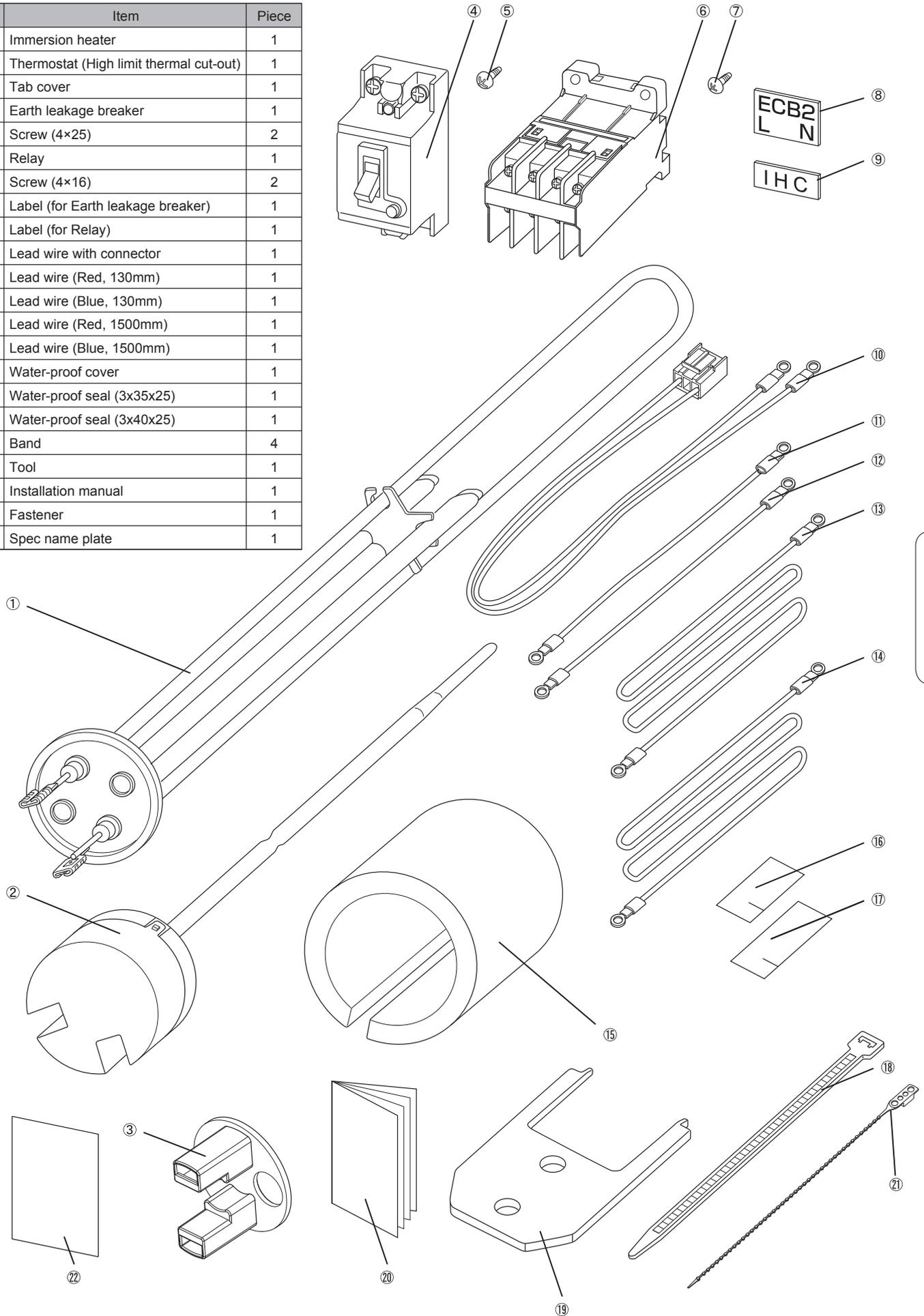

Optional parts

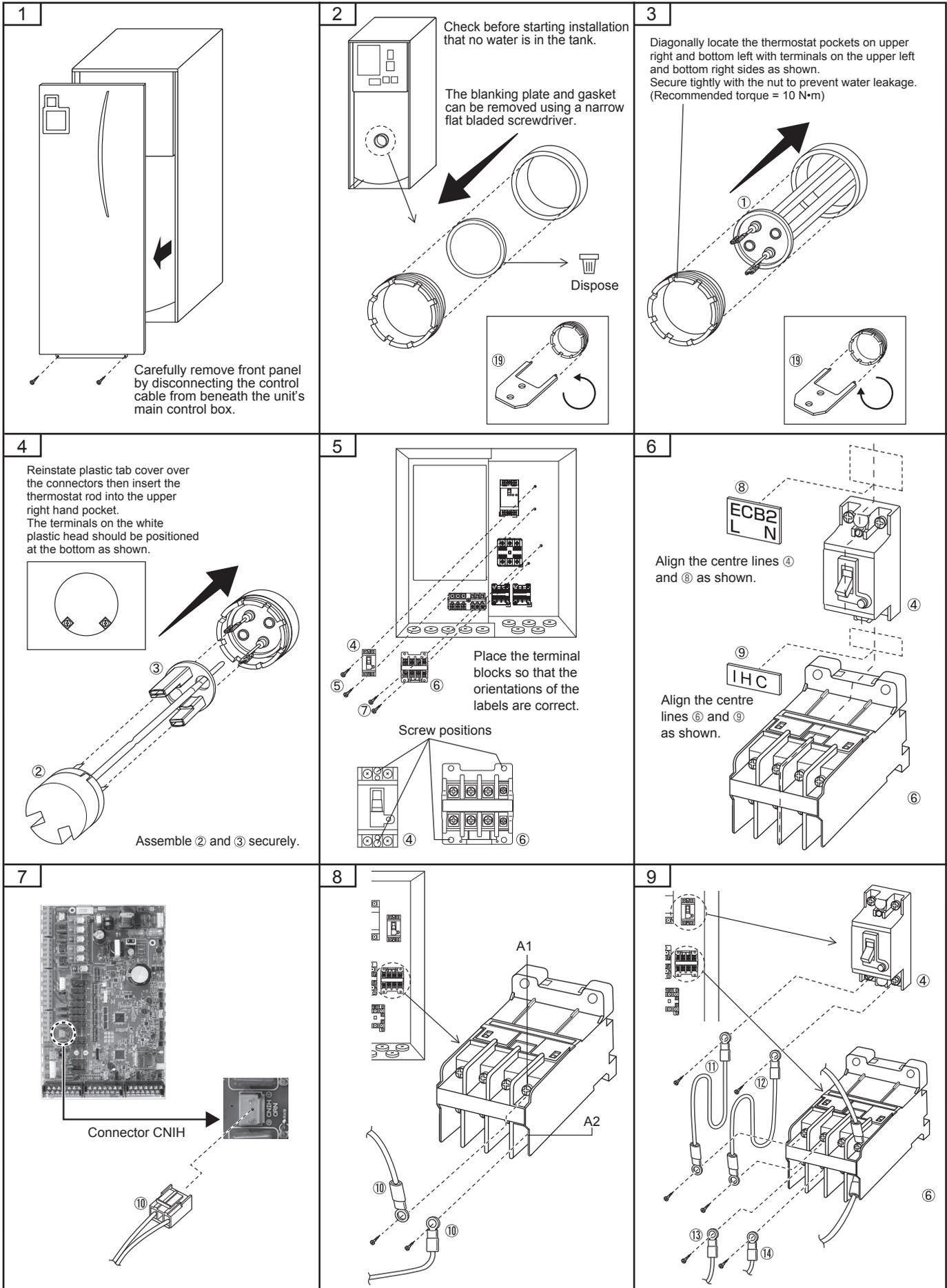

Optional parts

10

Do not insert the lead wires ⑬ and ⑭ into the opening that the main controller wires or the wireless receiver wires use.

11

12

Run the lead wire through the slit on the water-proof cover provided and seal each terminal screw.

13

Place the band on the joint surface of the DHW tank.
Secure the water-proof cover around the cylinder boss using the band provided.

14

DIP Switch
1-4 OFF→ON
(without immersion heater
→with immersion heater)

15

The fixing position of lead wire using bands and/or fasteners.

⑩ Fix it to the other wires.
⑪ Fix it to the pipe covers.

16

For details about wiring to power supply and circuit breaker, refer to the installation manual and wiring diagram for the cylinder unit.
Fill tank with water and ensure that no water leaks around the periphery of the immersion heater.

17

18

Carefully reinstate control cable connection before reinstating and securing the front panel.

Optional parts



CYLINDER UNIT OPTIONAL PARTS

EHPT ACCESSORIES for UK

PAC-WK01UK-E

INSTALLATION MANUAL

- Before starting installation, read the following description together with the installation manual included with the cylinder unit.
- Please read carefully and observe fully the following safety precautions.

⚠ WARNING Precautions that must be observed to prevent injuries or death.

- After installation carry out a test run to ensure correct operation, then explain operation method and safety precautions to the end user.
Tell your customers to keep this installation manual together with the operation manual, and when they give or sell this machine to any other person include this installation manual and operation manual with it.

Optional parts

⚠ WARNING

- Before installing any accessories on the cylinder unit ensure the unit is isolated from the power supply.
- Connections must be made securely and without tension on the terminals.
The included component parts of the PAC-WK01UK-E EHPT ACCESSORIES for UK shall be used only for the purposes indicated in the installation manual.

In addition to annual servicing it is necessary to replace or inspect the ICG after a certain period of system operation. Please see table below for detailed instructions. Replacement and inspection of the ICG should always be done by a competent person with relevant training and qualifications.

Part which requires regular replacement

Part	Replace every	Possible failures
Inlet control group (ICG)	6 years	Water leakage due to brass corrosion (Dezincification)

Contents

	Item	Piece(s)
①	Unvented inlet control group (Pressure reducing valve/strainer/check valves/expansion relief valve).	1
②	Blanking cap (22mm)	1
③	Nipple & Olive (15mm)	1
④	Expansion vessel 18L (R3/4")	1
⑤	Tundish (15mm, 22mm)	2
⑥	Filling loop (15mm)	1
⑦	Installation manual	1

The parts ① to ⑤ are provided to meet the requirements for the UK Building Regulation G3. The parts ② and ③ are accessory parts for the unvented inlet control group.

The pressure reducing valve is factory set at 3.5 bar and the expansion relief valve at 6.0 bar.

The gas charge pressure for the expansion vessel is 3.5 bar.

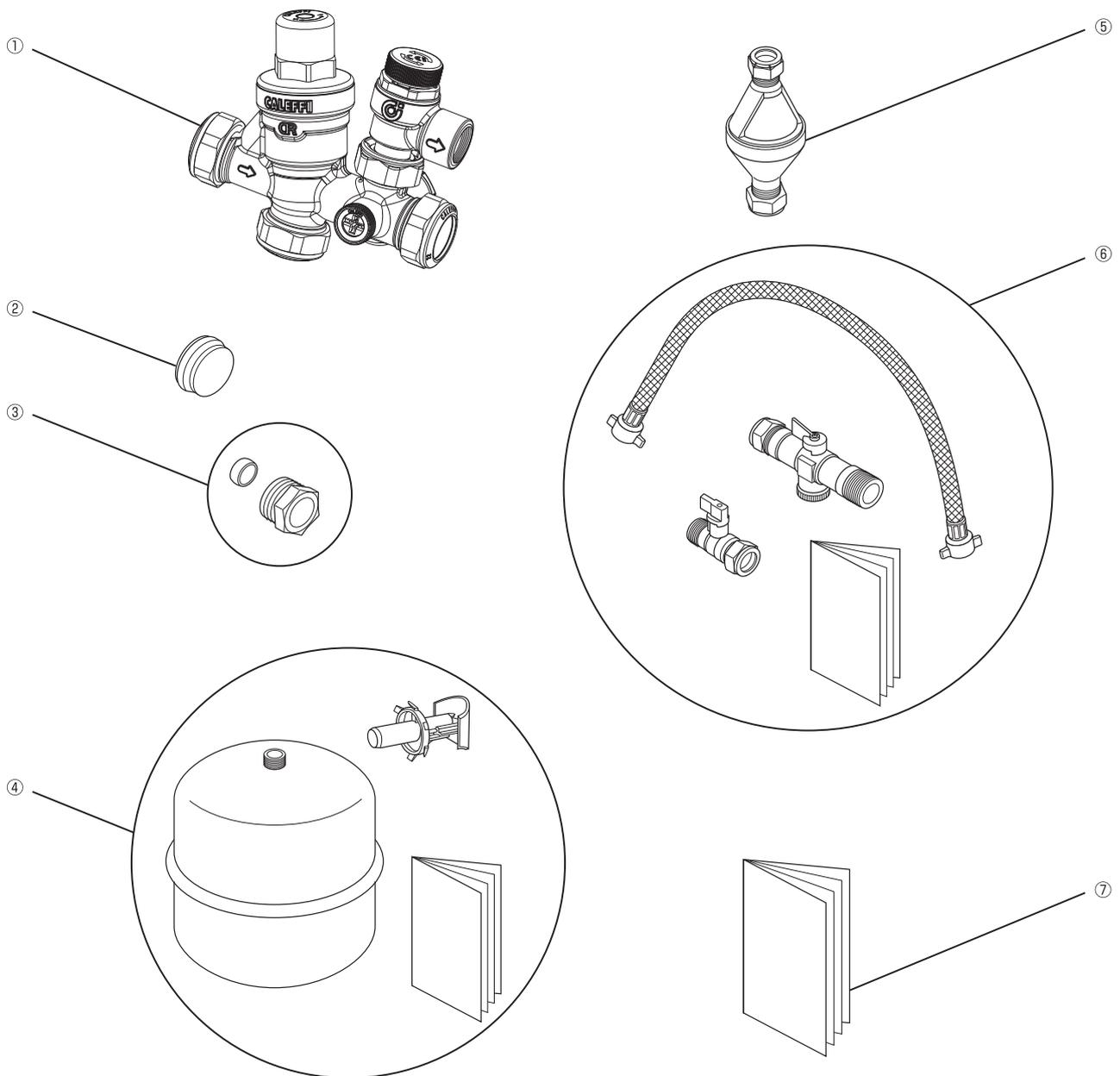

Optional parts

Installation

Carefully follow these instructions and ensure that the installation conforms to UK Building Regulation G3 and the Water Supply Regulations.

Unvented inlet control group (ICG)

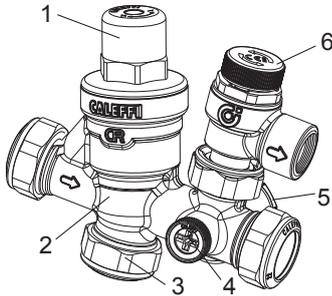

Item	Component
1	Pressure reducing valve
2	Manifold block (Including check valve)
3	22mm balanced cold water take-off
4	Pressure gauge port
5	3/4" connection for exp.vessel
6	Expansion relief valve

It is recommended that isolating valves are installed upstream and downstream to facilitate any future maintenance. For safety reasons, it is essential that no isolation valve is fitted between the ICG and the cold water inlet connection of the cylinder. Install the pressure reducing valve with its embossed arrow pointing in the direction of flow. Ensure the expansion relief valve is seated correctly into the main block/ casting and its nut is fully tightened to secure its position. Ensure that the expansion relief valve discharge pipework has a continuous fall and terminates via a tundish and in such a position as not to cause injury. The first 22mm connection (Item 3 above) can be used to provide an unbalanced cold water supply. It must never be used to connect the expansion vessel. If not used, use the blanking cap (22mm) supplied. The small black plug is a connection prepared for a pressure gauge, which is available when specified. On the opposite side of the manifold to the pressure gauge connection, there is a 3/4" plastic plugged connection that may be used for direct mounting to the expansion vessel if required.

Expansion vessel

Install the expansion vessel between the pressure reducing valve and the cylinder unit or by using the appropriate port of the ICG. (Ensure the expansion vessel is connected to an active section of the potable pipework and is NOT directly connected to any redundant "Dead-leg" section of pipework.)

Note:

- When connecting the ICG to the expansion vessel using a field-supplied flexible hose, provide sufficient bending radius to prevent abnormal noise.
- For more details about the following instructions, refer to the installation manual provided with the potable expansion vessel, as well as this manual.
 - If the expansion vessel is installed separately to the ICG (ie. direct in-line) then the supplied flow diverter can be used.
 - ICG should always be installed on cold water supply to cylinder to comply with WRAS/Building Regulation G3.
 - The ICG. should be installed above the level of the T&P valve. This will avoid the requirement to drain cylinder when servicing the ICG in future.
 - Expansion vessel should be installed hanging from connecting pipework.
 - Expansion vessel should be fastened to a suitable surface (wall etc.) to prevent strain on pipe connection.
 - Gas inlet screw type of expansion vessel: 8V1

Tundish

Install the tundishes in accordance with the UK Building Regulation G3. For more details refer to the "Safety Device Discharge Arrangements" section in the installation manual for the cylinder unit .

Filling loop

Note: Refer to the installation manual provided with the filling loop as well.

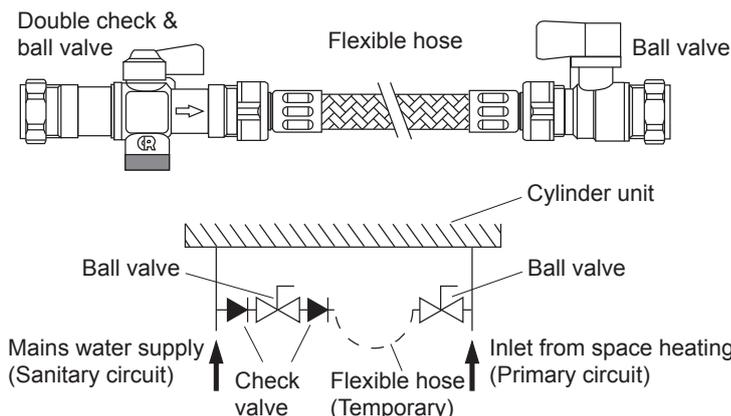

Optional parts

The procedure and recommendations specified in the cylinder unit installation manual for filling and pressurising the primary heating circuit of the cylinder unit must be followed.

The heating return pipe and the cold water supply pipe must be provided with tees with a short length of R250 (half hard) copper tube in the side port.

Fit the double check valve to the pipe from the mains supply pipe using the compression joint, which complies with BS EN 1252-2, ensuring that the flow through the valve is in the same direction as the arrow on the body.

Fit the ball valve to the pipe from the heating return using the compression joint.

Connect the flexible hose between the double check valve and ball valve and tighten the wing nuts to make water tight joints.

Open both ball valves and fill the system, when the pressure starts to increase on the cylinder unit pressure gauge partially close the ball valve on the double check valve to control the pressure to that specified by the cylinder unit installation manual.

Once filling and pressurisation have been completed, close both ball valves and remove the flexible hose.

If the flexible hose is removed it is recommended that caps (not supplied) are fitted to both valve connections to prevent any potential leakage.

Maintenance and service

Pressure reducing valve

Under normal circumstances the pressure reducing valve should not require any maintenance, but regular inspection and cleaning is recommended.

If the strainer or cartridge are damaged replace entire valve.

1. Isolate the water supply to the pressure reducing valve.
2. Unscrew anticlockwise the central calibration screw to decompress the spring.
3. Remove the plastic cover using a spanner on the hexagon faces.
4. Extract the cartridge with the aid of long nosed pliers to grip the head of the set screw.
5. Remove the strainer element.
 - *If the strainer or cartridge are damaged replace item(s) accordingly.
6. Clean the strainer element and cartridge under clean running water.
7. Replace the strainer, cartridge and cover.
8. Turn on the water supply and check for leakage.
9. Re-calibrate the pressure reducing valve. (Rotate it clockwise to increase the outlet pressure and anticlockwise to reduce it.)

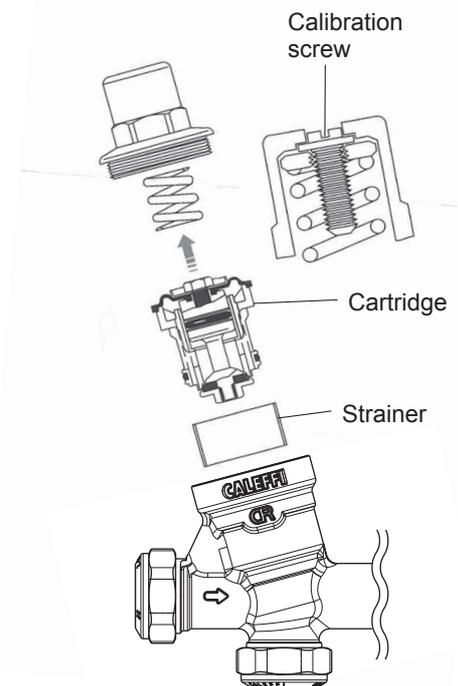

Optional parts

Expansion relief valve

Manually operate (rotate head anti-clockwise) the expansion relief valve to ensure free water flow through discharge port and connecting pipe.

Expansion vessel

The pre-charge gas pressure must be checked annually to make sure that the expansion vessel is in working order.

If water discharges through the expansion relief valve, it is possible that the expansion vessel's existing gas pre-charge pressure is too low.

Check this in the following manner:

1. Close the water supply.
2. Drain the sanitary circuit until the pressure is 0 bar.
3. Check the pre-charge.
4. Increase the gas pre-charge pressure with nitrogen/air to 3.5 bar.

Make sure that the pre-charge is not higher than the maximum working pressure.

If the expansion vessel cannot be pressurized, it is possible that the membrane has a leak.

If so, you must then replace the expansion vessel.



PARTS NAME : HIGH TEMP. THERMISTOR

PARTS No. : PAC-TH011HT-E <G>

SALES MODEL CODE : 7H1THR2G



MITSUBISHI ELECTRIC CORPORATION

INSTALLATION MANUAL

- Before starting installation, read the following description together with the installation manual included with the unit.
- Please read carefully and observe fully the following safety precautions.

⚠ WARNING Precautions that must be observed to prevent injuries or death.

- After installation carry out a test run to ensure correct operation, then explain operation method and safety precautions to the end user.
- Tell your customers to keep this installation manual together with the operation manual, and when they give or sell this machine to any other person include this installation manual and operation manual with it.

⚠ WARNING

- Before installing any accessories on the unit ensure the unit is isolated from the power supply.
- Connections must be made securely and without tension on the terminals.
- All electrical work should be performed by a qualified technician according to local regulations and the instructions given in this manual.
- The flow temperature from boiler MUST NOT exceed 70 °C (*1).
- Before running Floor Dry-up function, disconnect IN4 and IN5 wirings. (*2)

*1 When the temperature sensed by flow temp. thermistor or return temp. thermistor exceeds 80°C, FTC4 will detect it as overheat error.
*2 High-temperature water produced by boiler operation could flow in and this could cause a big damage to the floor.

- Make sure to install the boiler that has overheat protection and output flow temperature control.

Optional parts

<Included items>

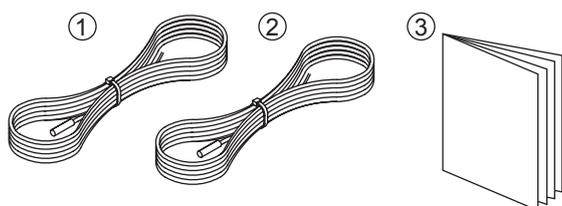

	Item	Piece
①	Boiler flow temp. thermistor (THWB1) 5 m, color: gray	1
②	Boiler return temp. thermistor (THWB2) 5 m, color: black	1
③	Installation manual	1

<Connecting boiler thermistor>

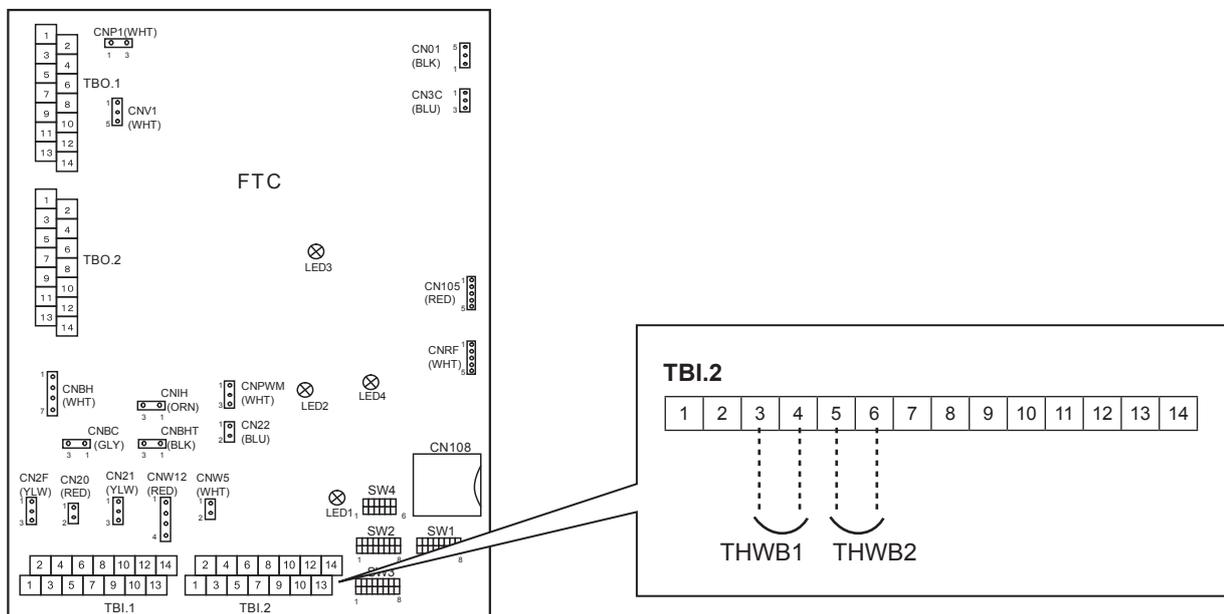

1. System

- Heat source can be switched between heat pump and boiler by external input from power supplier or outdoor temperature thermistor.
- Heat source can be switched according to running cost, CO₂ emission, or outdoor temp.
- In case of outdoor unit failure, backup operation is possible with boiler. *1

*1 When Hybrid is selected as heat source.

When Dip SW2-5 (Automatic switch to backup heat source operation) is set to ON.

Note: FTC4 can control boiler only in space heating mode.

Heat source	Heating	DHW
Heat pump	✓	✓
Boiler	✓	—

1.1 Room thermostat connection

IMPORTANT NOTE

Be sure to connect room thermostat to FTC4.

When boiler is running, the heating operation is regulated by the room thermostat connected to FTC4.

a) Heating room temperature (🏠)

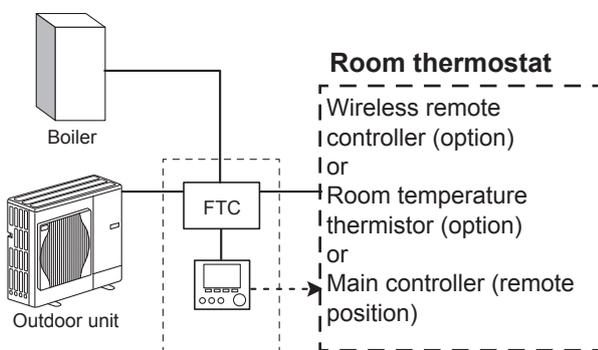

b) Heating flow temperature (🌡️)

c) Heating compensation curve (📈)

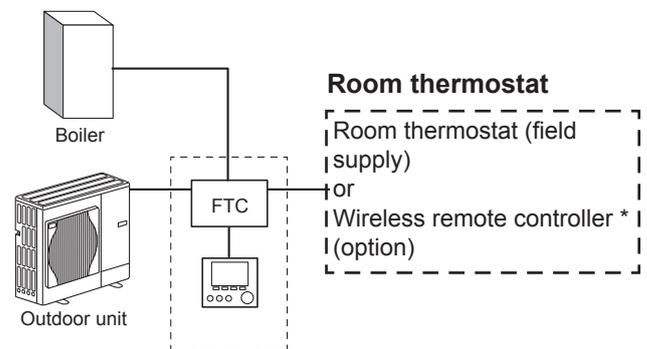

* Wireless remote controller can be changed to room thermostat.

1.2 Pipe work

- Boiler and heat pump are connected in parallel.
- Install a mixing tank (field supply).
- Put 2 thermistors in boiler circuit. (THWB1: Flow temp., THWB2: Return temp.)

* It is recommended to protect the thermistors with heat insulating materials so as not to be affected by ambient temperature.
 Note: These lead wires of the thermistors must avoid being in contact with pipe surfaces.

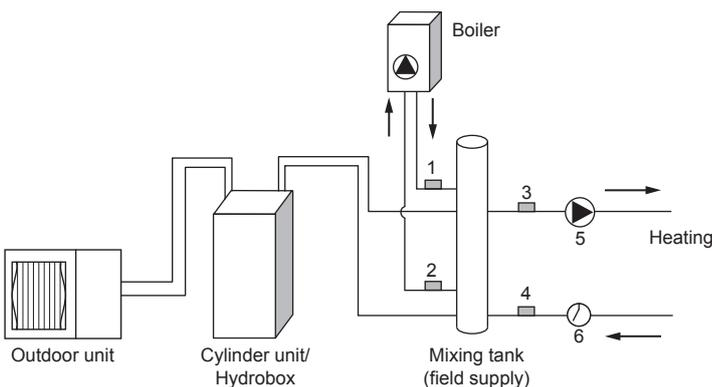

Number	Component
1	Boiler flow temp. thermistor (THWB1)
2	Boiler return temp. thermistor (THWB2)
3	Flow temp. thermistor (THW6) (option)
4	Return temp. thermistor (THW7) (option)
5	Circulation pump (field supply)
6	Flow switch (field supply) *1

*1 For safety protection, it is recommended to install a flow switch.

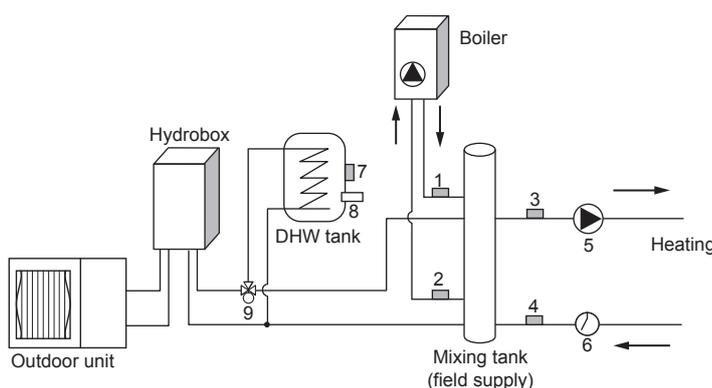

Number	Component
1	Boiler flow temp. thermistor (THWB1)
2	Boiler return temp. thermistor (THWB2)
3	Flow temp. thermistor (THW6) (option)
4	Return temp. thermistor (THW7) (option)
5	Circulation pump (field supply)
6	Flow switch (field supply) *1
7	Tank water temp. (THW5)
8	Immersion heater (field supply)
9	3-way valve (field supply) *2

*1 For safety protection, it is recommended to install a flow switch.

*2 The use of two 2-way valves can perform the same function as a 3-way valve.



CYLINDER UNIT OPTIONAL PARTS

DRAIN PAN STAND

PAC-DP01-E

INSTALLATION MANUAL

- This drain pan stand MUST be used with cylinder unit ERST series.
- Before starting installation, read the following description together with the installation manual included with the cylinder unit.
- Please read carefully and observe fully the following safety precautions.

⚠ WARNING Precaution that must be observed to prevent injuries or death.

⚠ CAUTION Incorrect handling could lead to injury or damage to house and household articles.

- After installation carry out a test run to ensure correct operation, then explain operation method and safety precautions to the end user.

Tell your customers to keep this installation manual together with the operation manual, and when they give or sell this machine to any other person include this installation manual and operation manual with it.

⚠ WARNING

- If the cylinder has already been connected to the power supply ensure circuit breaker is off before carrying out electrical work.
- If the drain pan stand is installed incorrectly or modified after installation by the user, water may leak or cylinder unit may fall.
- All installation should be performed by a qualified technician according to local regulations and the instructions given in this manual.

⚠ CAUTION

- Securely apply heat-insulation to draining pipework. If heat-insulation is inadequate, condensation could occur on the surface of pipes and dew could drop on the floor or important goods.
- To prevent dirty water from draining onto the floor next to cylinder unit, please connect appropriate discharge pipework from the cylinder drain pan to its disposal location.
- The cylinder unit should be positioned on a level surface capable of supporting its filled weight. (Adjustable feet (accessory parts of cylinder unit) can be used to ensure unit is level.)
- Secure cylinder unit to prevent it being knocked over.

Contents

	Item	Q'ty
①	Foundation assy	1
②	Joint plate	4
③	Screw (4×12)	24
④	Drain socket	1
⑤	Drain hose (insulated)	1
⑥	Band	1
⑦	Front panel stay	2
⑧	Painted screw (4×10)	8
⑨	Drain guide side	2
⑩	Design panel side	2
⑪	Drain guide front	1
⑫	Design panel front	1
⑬	Installation manual	1

Location of DRAIN PAN STAND

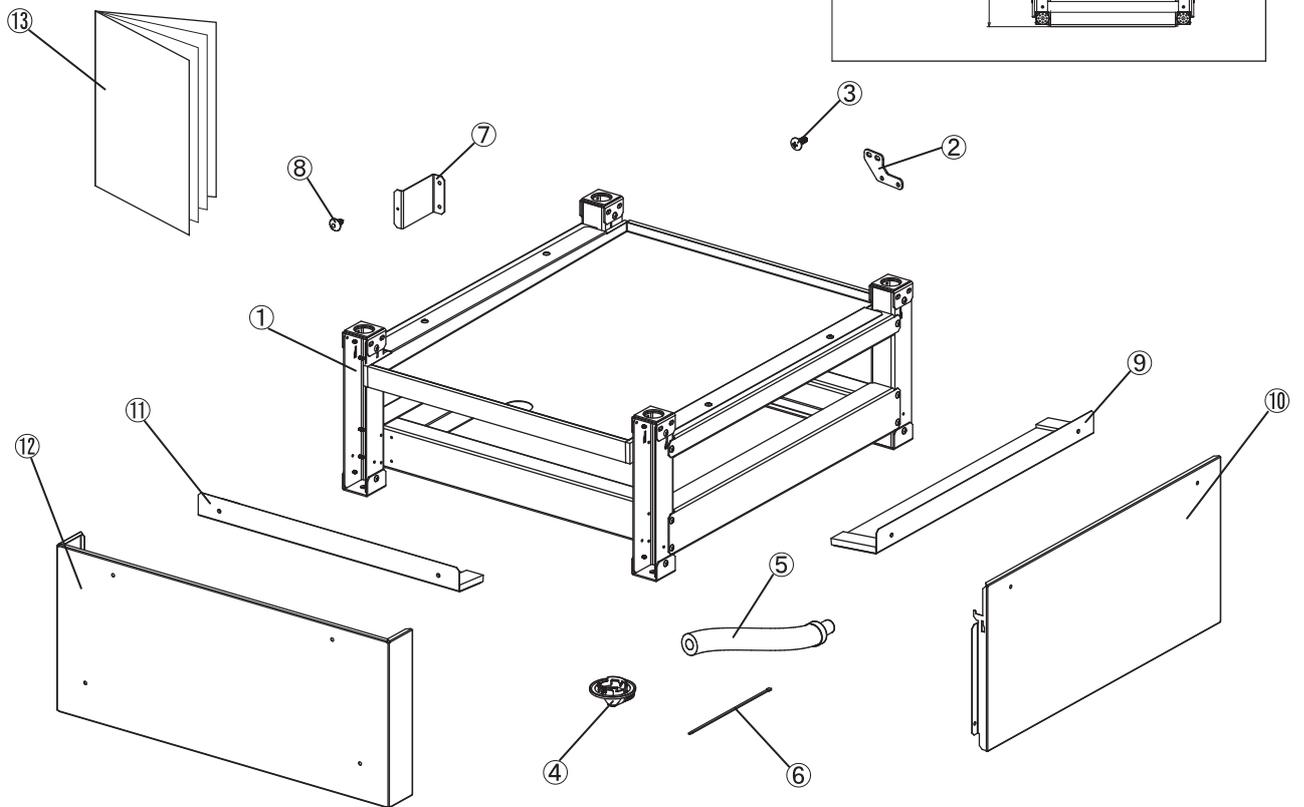
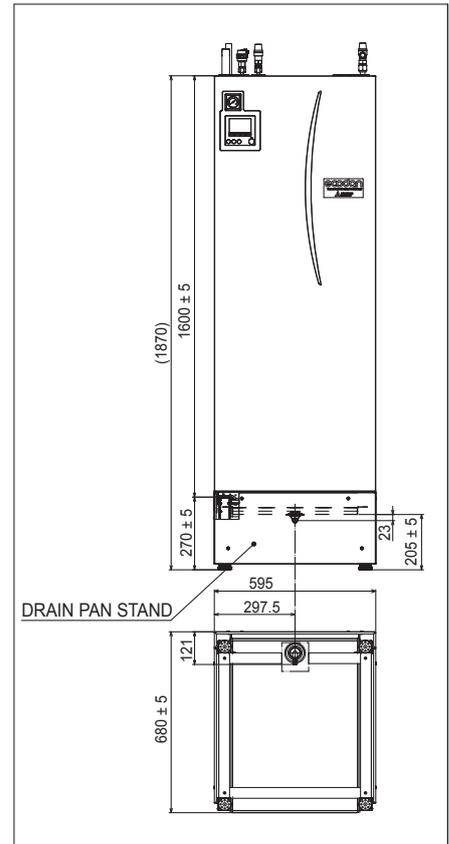

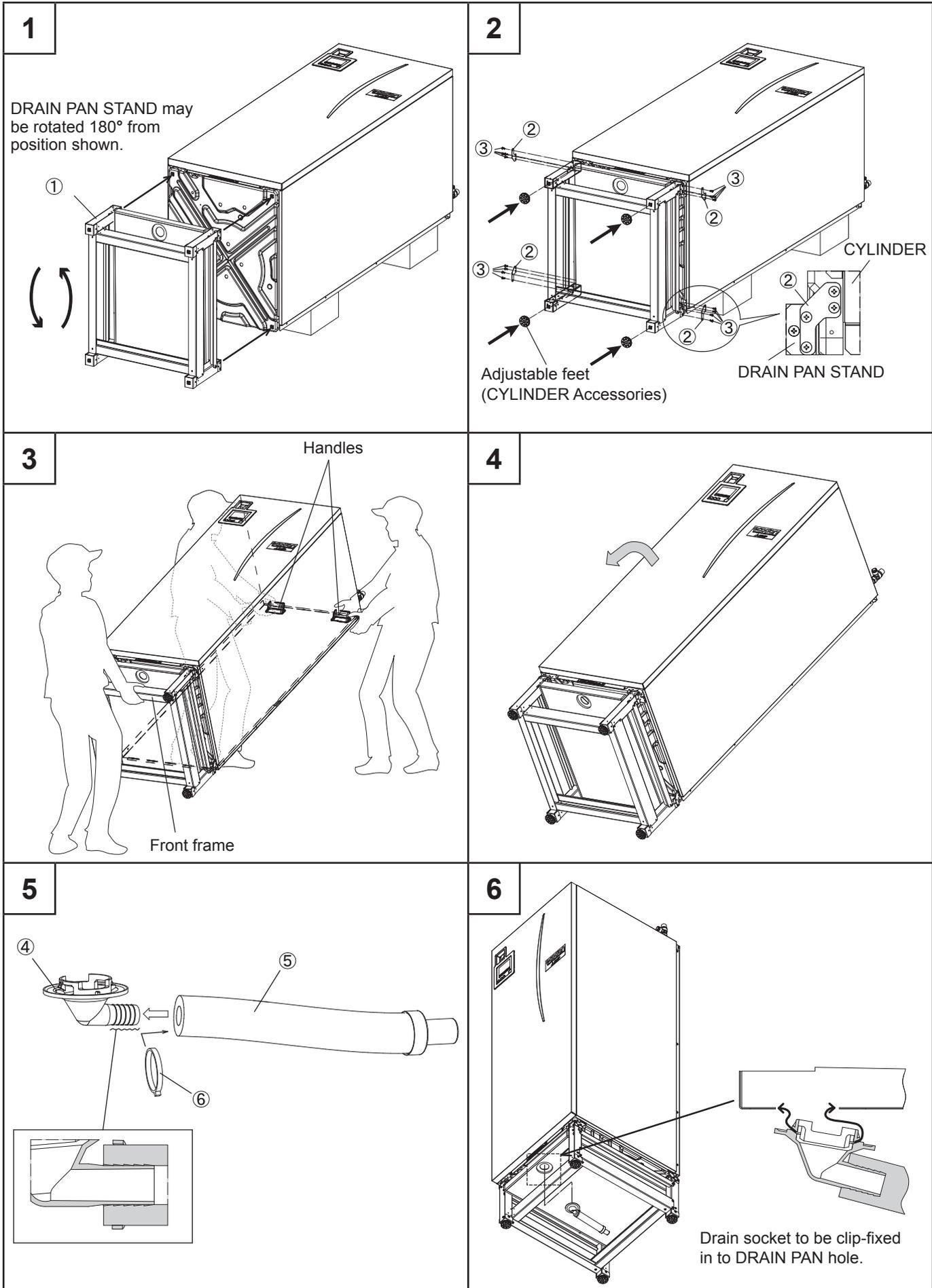

Optional parts

7

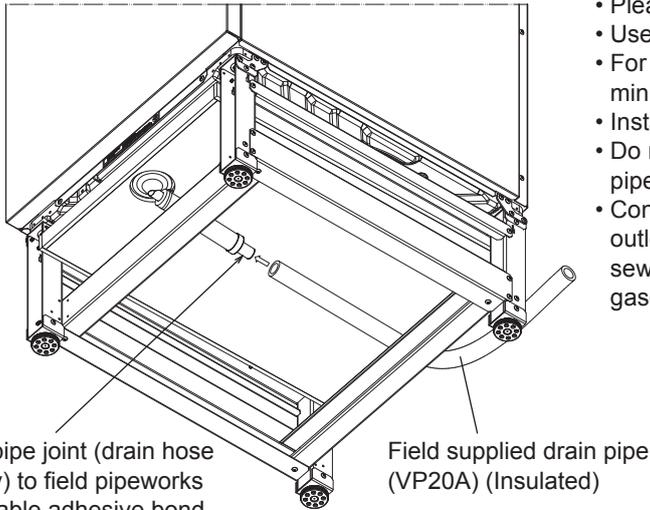

NOTE

- Please use rigid PVC for field pipework.
- Use only compatible adhesive/glue for pipe joint.
- For proper drain-off, install pipework with gradient/fall of min. 1/100.
- Install pipe to fall continuously without bowing.
- Do not install any air purge points on condensate drain pipe run.
- Condensate drain pipe must discharge to suitable and safe outlet location. It should not be directly connected to any sewer-connected pipework that may introduce sulphurous gases/smells to the building.

8

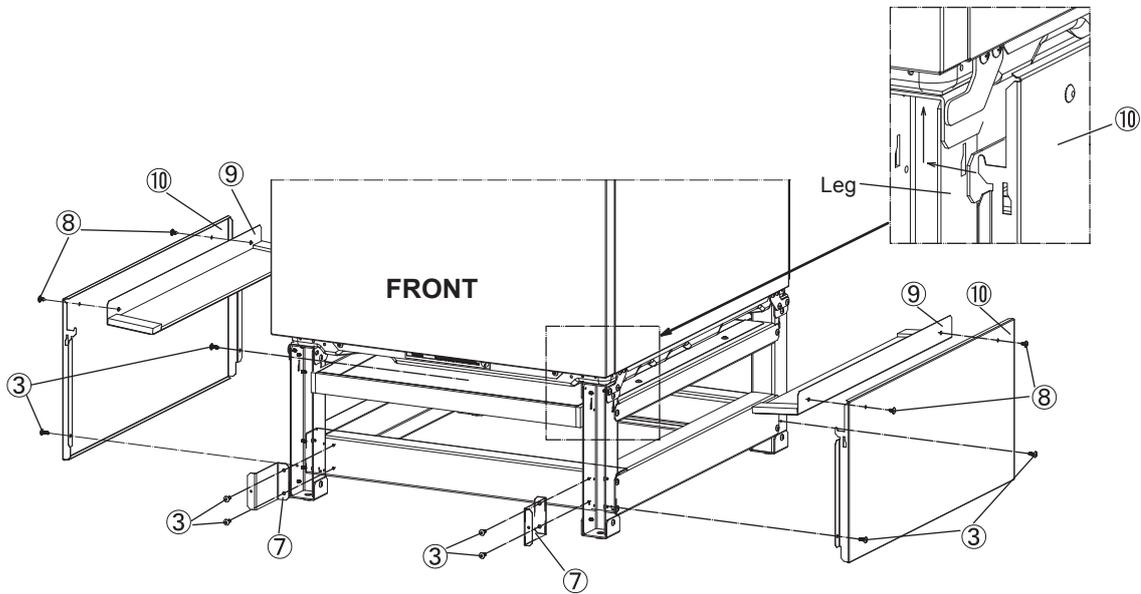

9

Note

- Before fitting the front panel, test by gradually pouring 1 litre of water into the drain pan.
- Check that the water drains properly from the outlet of the pipe and suitably discharges to safe outlet location.
- Check also for any leakage from the connections.

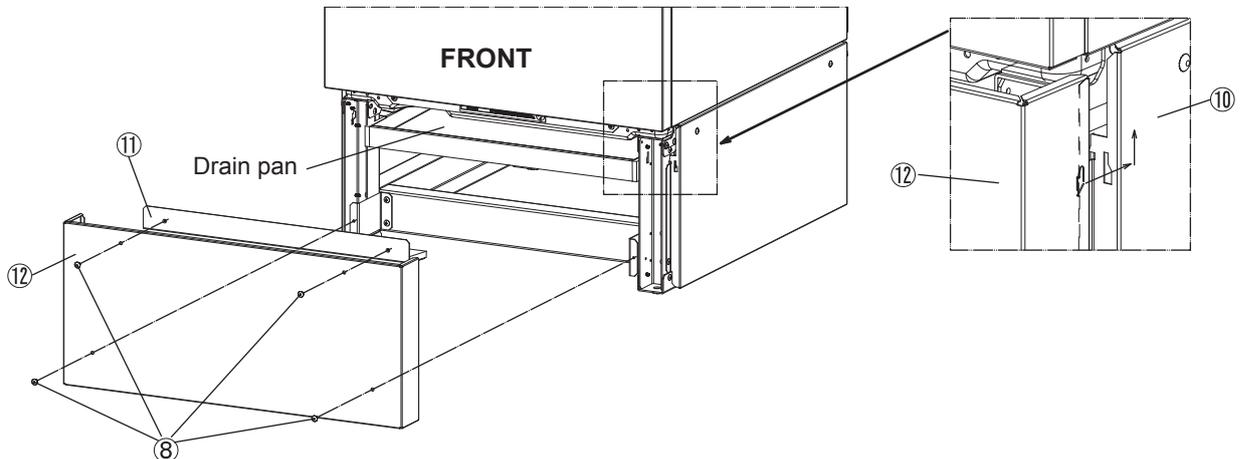



ATW INDOOR UNIT OPTIONAL PARTS

2 ZONE KIT

PAC-TZ01-E

INSTALLATION MANUAL

- This 2 zone kit **MUST** be used with Cylinder unit or Hydrobox **except for E•SE models**.
- Before starting installation, read the following description together with the installation manual included with the Cylinder unit (Hydrobox).
- Please read carefully and observe fully the following safety precautions.

WARNING	Precaution that must be observed to prevent injuries or death.
CAUTION	Incorrect handling could lead to injury or damage to house and household articles.

- After installation, carry out a test run to ensure correct operation, then explain operation method and safety precautions to the end user.
Tell your customers to keep this installation manual, and when they give or sell this machine to any other person include this installation manual with it.

WARNING

- If Cylinder unit (Hydrobox) has already been connected to the power supply, ensure circuit breaker is off before carrying out electrical work.
- If the 2 zone kit is installed incorrectly or modified after installation by the user, water may leak or 2 zone kit may fall from Cylinder unit or wall.
- All installation should be performed by a qualified technician according to local regulations and the instructions given in this manual.
- Connections must be made securely and without tension on the terminals.

CAUTION

- The 2 zone kit must be installed by 2 or more people.
- All exposed water pipework should be insulated to prevent unnecessary heat loss and condensation.
- To also use the 2 zone kit in Cooling mode, securely apply heat-insulation to draining pipework. If heat-insulation is inadequate, condensation could occur on the surface of pipes and dew could drop on the floor or important goods.
- To prevent dirty water from draining onto the floor next to Cylinder unit or under Hydrobox, please connect appropriate discharge pipework from the 2 zone kit to its disposal location.
- Secure 2 zone kit to prevent it from falling.
- Do not hold piping or drain socket when moving the 2 zone kit.
- Avoid the connection of piping or drain socket from damage. Otherwise, it may cause water leakage.
- To prevent incorrect installation, please connect the flexible hose at the bend radius of 150 mm or more.
- The water flow rate between the Cylinder unit (Hydrobox) and the 2 zone kit must be greater than the total flow rate of Zone1 and Zone2. Otherwise, Zone1 and Zone2 may not be heated properly.

Disposal of the Unit

Note: This symbol mark is for EU countries only.

This symbol mark is according to the directive 2012/19/EU Article 14 Information for users and Annex IX, and/or to the directive 2006/66/EC Article 20 Information for end-users and Annex II.

Your Mitsubishi Electric heating system products have been manufactured with high quality materials and components which can be recycled and/or reused. The symbol in Figure 1.1 means that electrical and electronic equipment, batteries and accumulators at the end of their life, should be disposed of separately from your household waste.

If a chemical symbol is printed beneath the symbol (Figure 1.1), this chemical symbol means that the battery or accumulator contains a heavy metal at a certain concentration. This is indicated as follows;

Hg: mercury (0.0005%), Cd: cadmium (0.002%), Pb: lead (0.004%)

In the European Union there are separate collection systems for used electrical and electronic products, batteries and accumulators.

<Figure 1.1>

Please dispose of this equipment, batteries and accumulators correctly at your local community waste collection/recycling centre.

Contact your local Mitsubishi Electric dealer for country-specific details on disposal.

Please, help us to conserve the environment we live in.

Contents

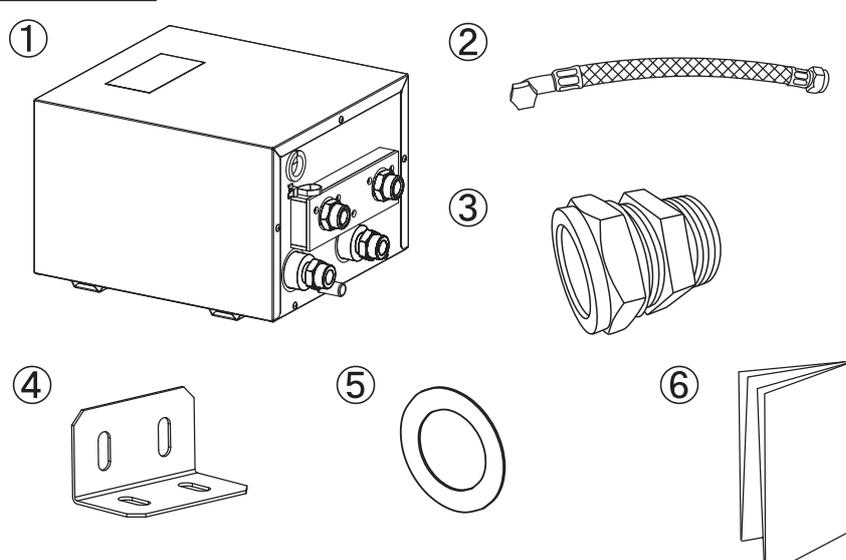

Item	Q'ty
① 2 zone kit	1
② Flexible hose (520mm)	2
③ Conversion joint (Φ28 → G1)	2
④ Fixing plate	2
⑤ Gasket	4
⑥ Installation manual	1
⑦ Screw (M5×8)	2

Outline

Unit: mm

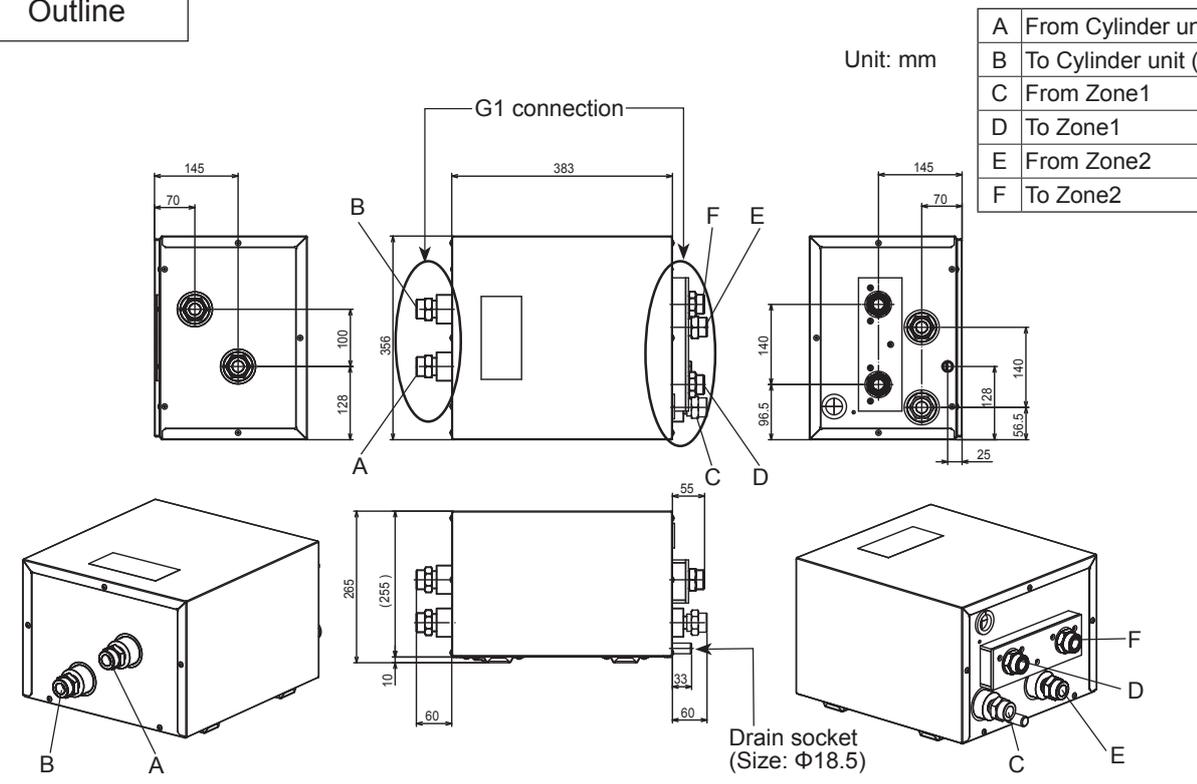

A	From Cylinder unit (Hydrobox)
B	To Cylinder unit (Hydrobox)
C	From Zone1
D	To Zone1
E	From Zone2
F	To Zone2

Drain socket (Size: Φ18.5)

Component parts

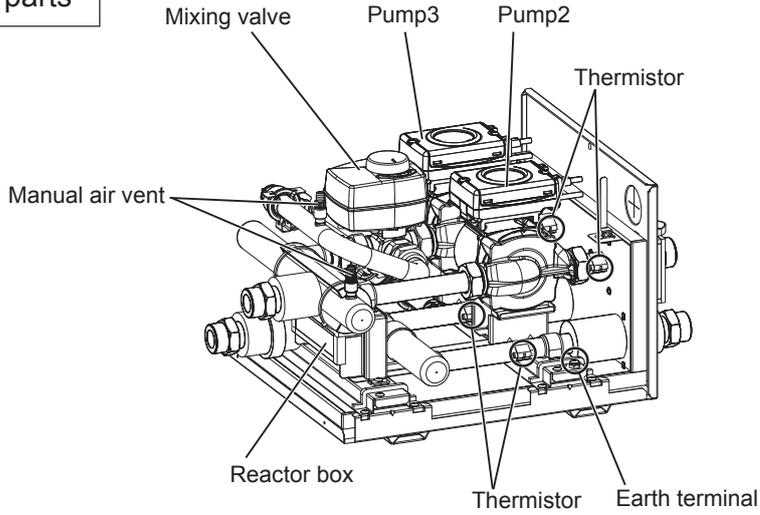

Installation position

<Cylinder unit>

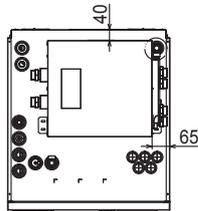

<Hydrobox>

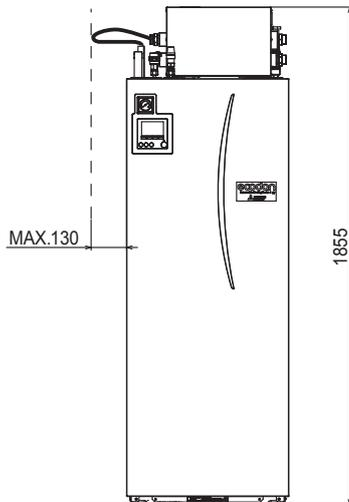
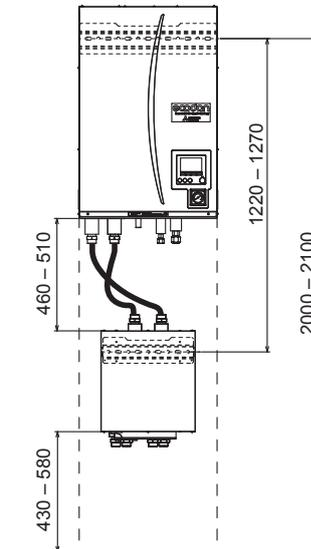

Optional parts

Water circuit and system figure

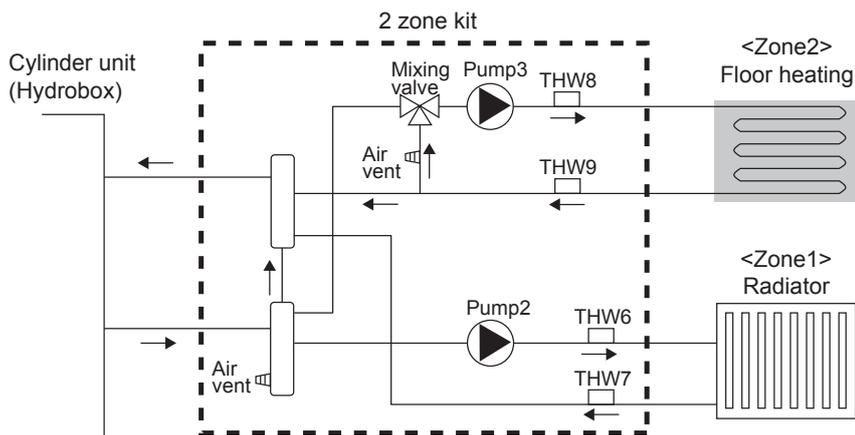

1 In the case of Cylinder unit

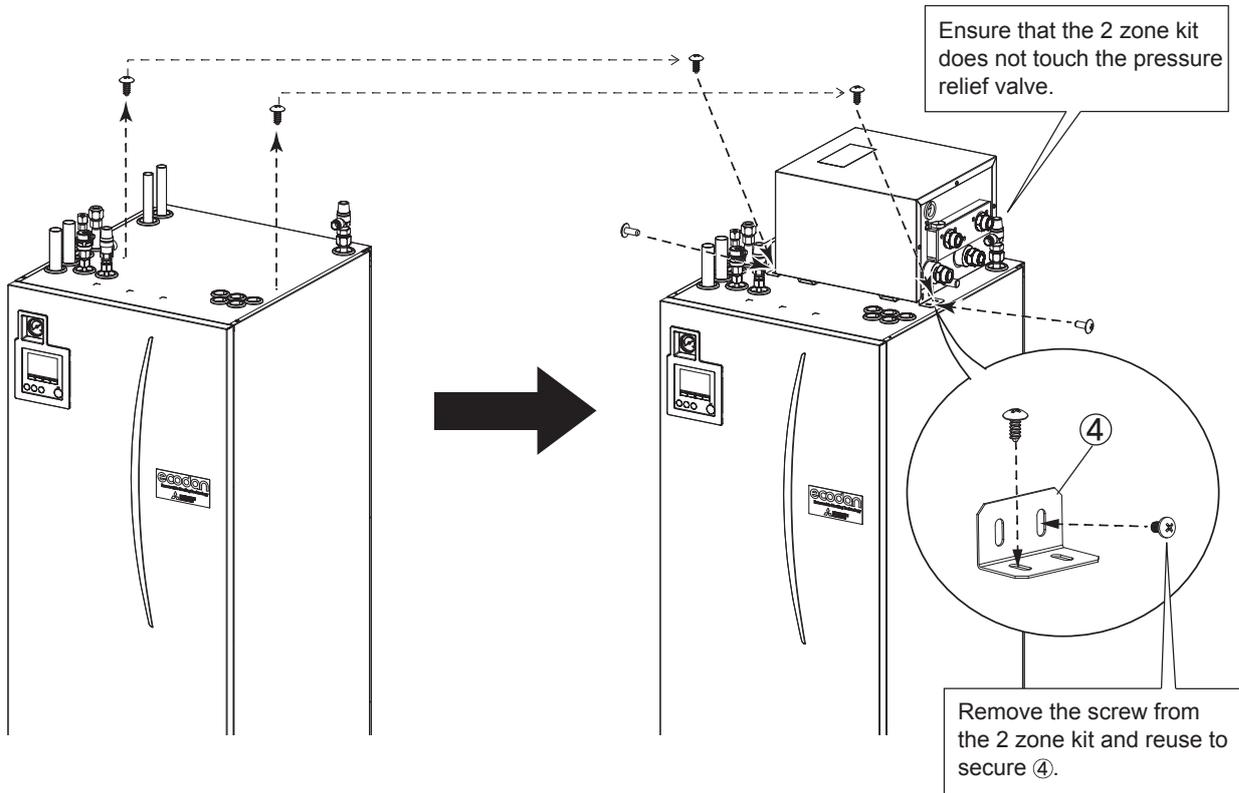

2 In the case of Cylinder unit

After hand tighten the nut, tighten the joint 1 turn.
If necessary, tighten by another 1/4 of a turn.

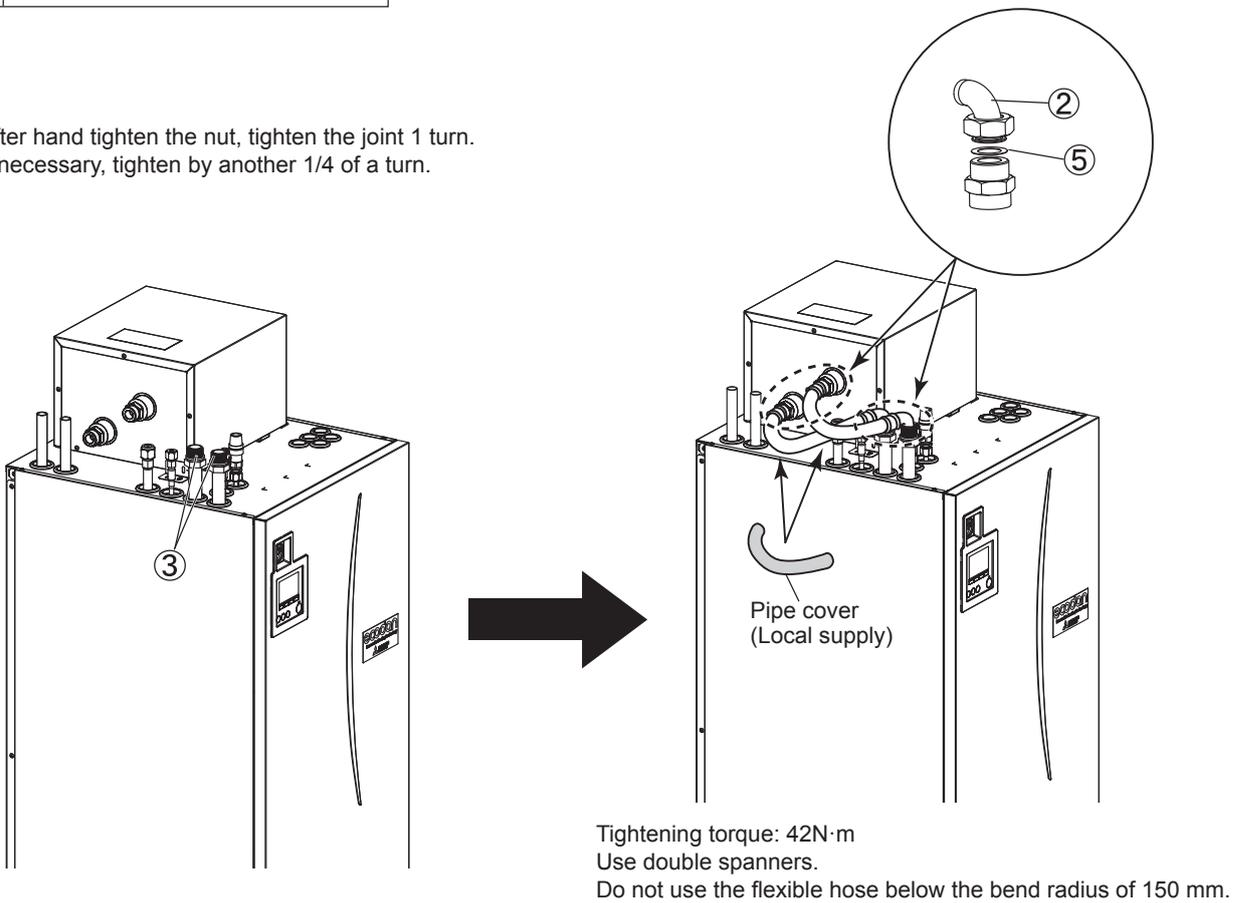

Optional parts

1 In the case of Hydrobox

1.

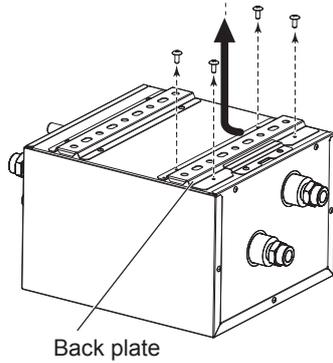

Back plate

2.

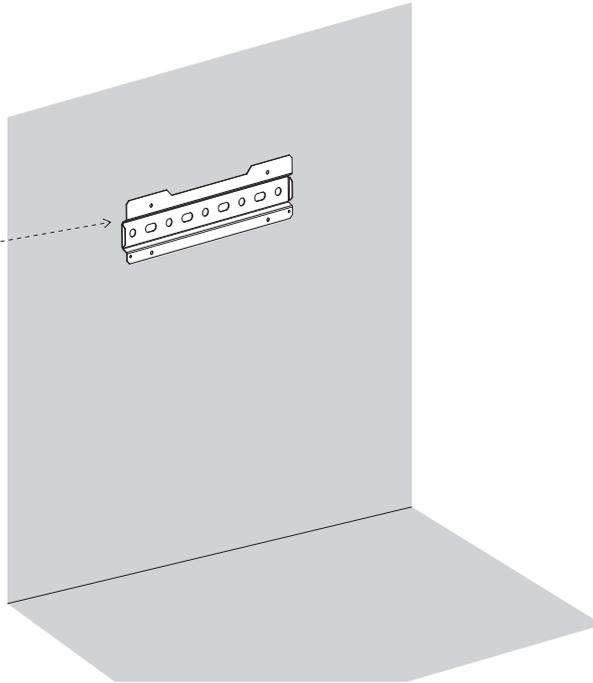

<Side view>

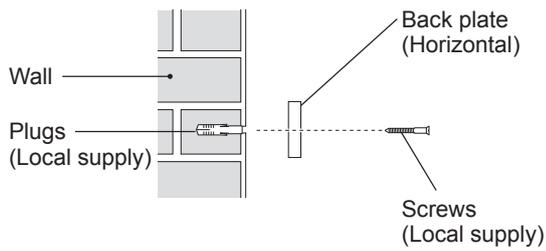

- Ensure that the notch is positioned at the TOP of the back plate. The back plate is provided with screw mounting holes that are round or oval. To prevent the 2-zone kit from falling off the wall, choose the appropriate number of holes or hole positions and horizontally secure the back plate to the appropriate wall location.

2 In the case of Hydrobox

1.

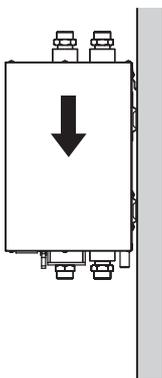

2.

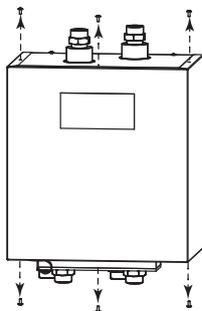

3.

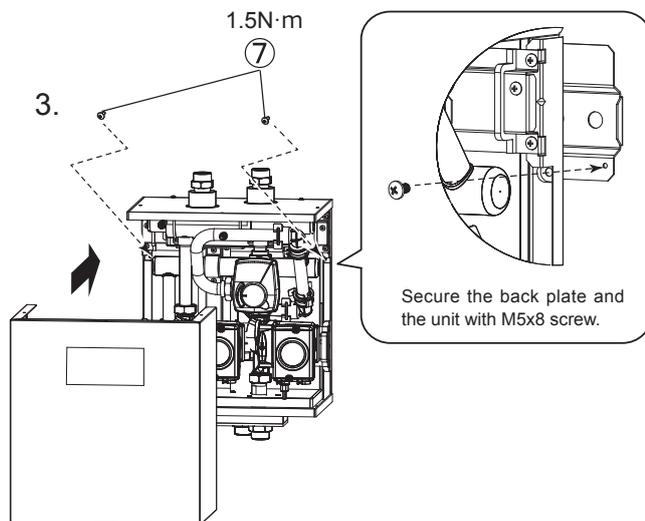

Secure the back plate and the unit with M5x8 screw.

Optional parts

3 In the case of Hydrobox

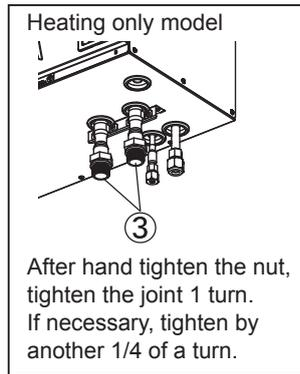

After hand tighten the nut, tighten the joint 1 turn. If necessary, tighten by another 1/4 of a turn.

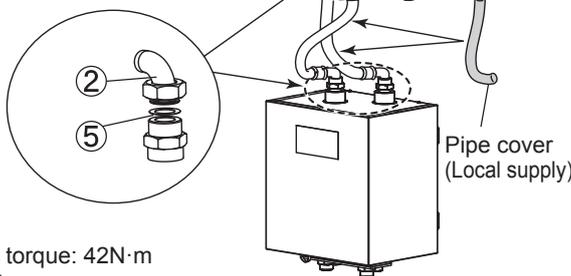

Tightening torque: 42N·m
Use double spanners.
Do not use the flexible hose below the bend radius of 150 mm.

<View from below>

Heating only model

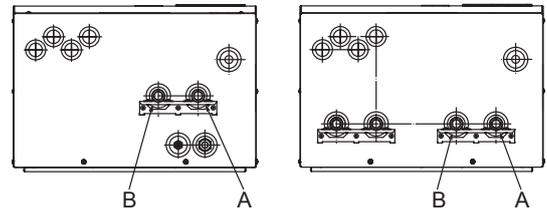

Heating and cooling model

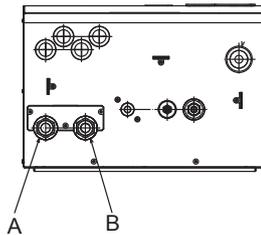

Letter	Pipe description
A	Space heating/Indirect DHW tank (primary) return connection
B	Space heating/Indirect DHW tank (primary) flow connection

Drain piping

Connect the drain pipe only for Heating/Cooling models.

<Cylinder unit>

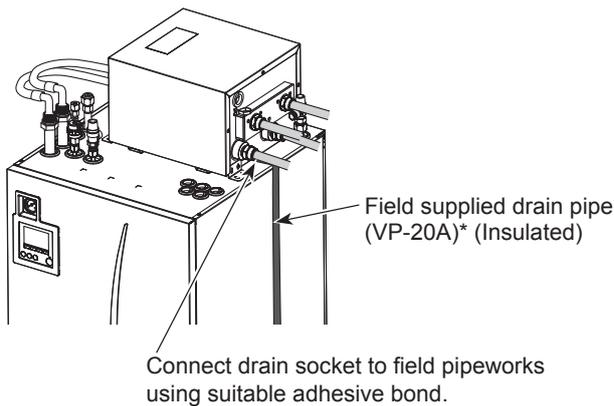

<Hydrobox>

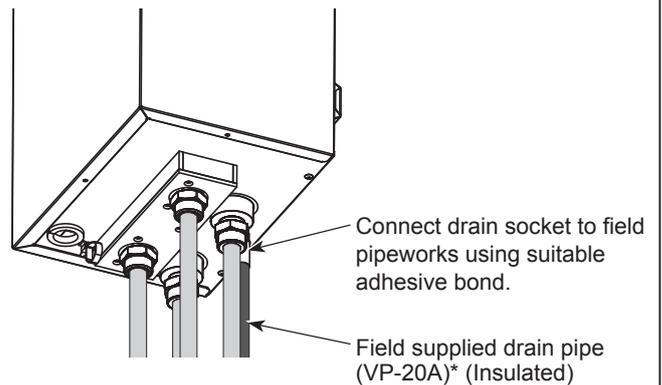

NOTE

- Please use PVC pipe for drain piping.
- Use only compatible adhesive/glue for pipe joint.
- For proper drain-off, install pipework with gradient/fall of min. 1/100.
- Install pipe to fall continuously without bowing.
- Do not install any air purge points on condensate drain pipe run.
- Condensate drain pipe must discharge to suitable and safe outlet location. It should not be directly connected to any sewer-connected pipework that may introduce sulphurous gases/smells to the building.

* "VP-20" is a PVC pipe with an outside diameter of 26 mm and an inside diameter of 20 mm.

Wiring

<Cylinder unit>

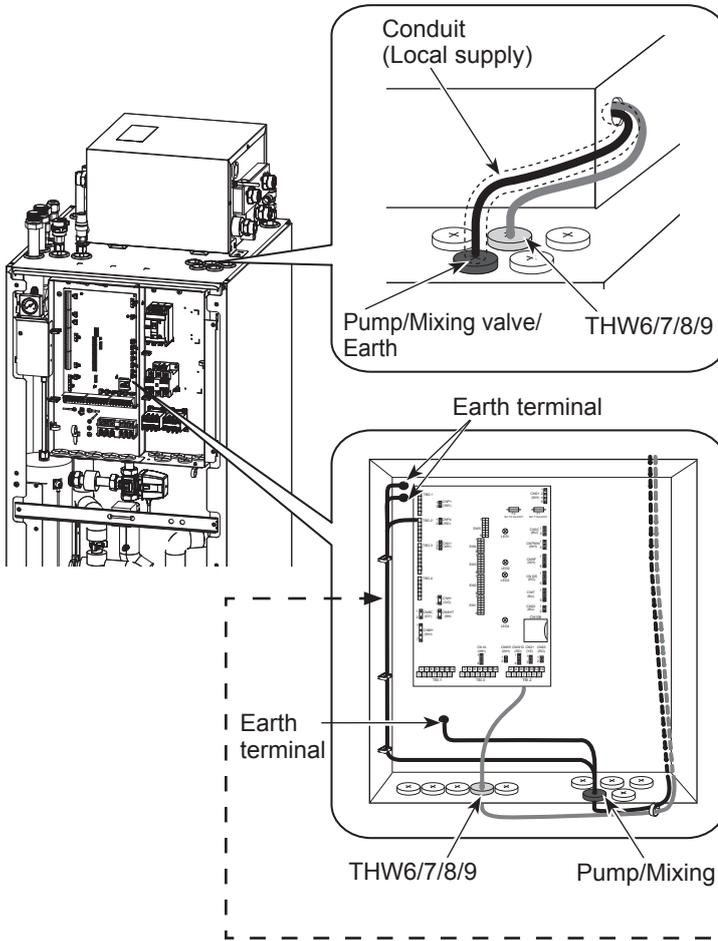

<Hydrobox>

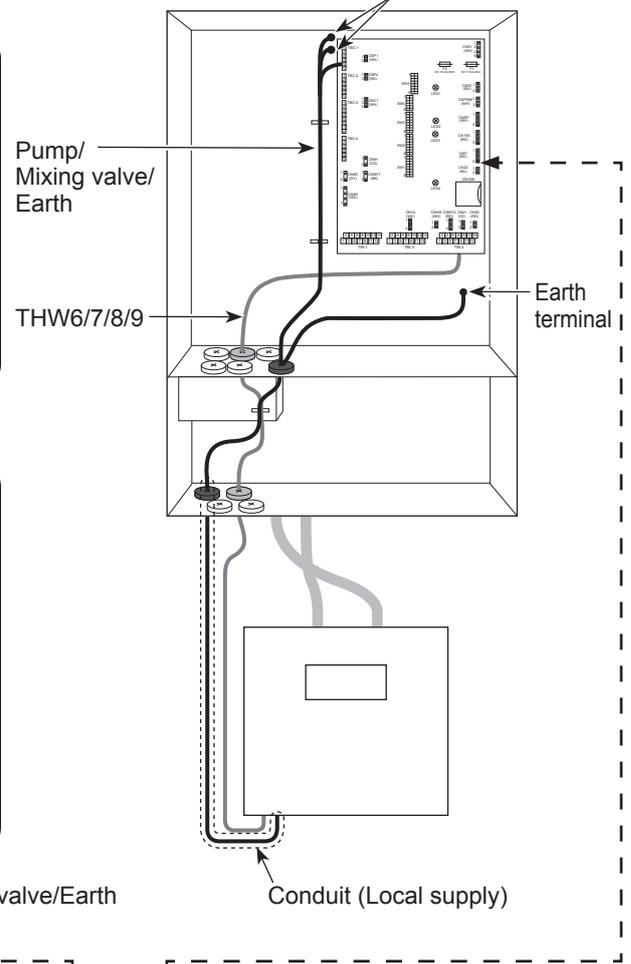

Optional parts

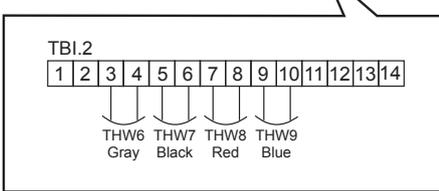
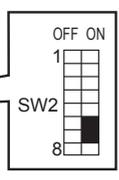
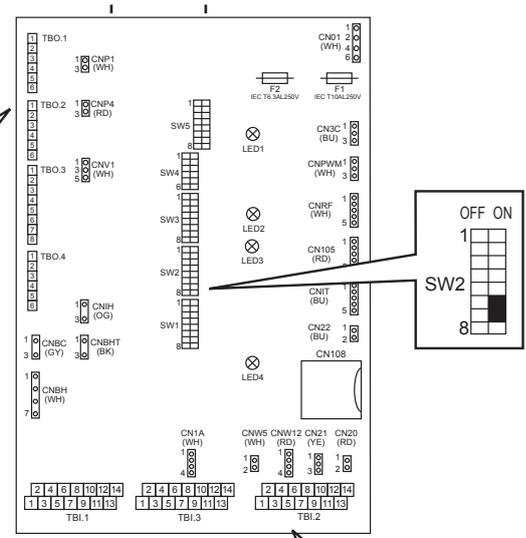
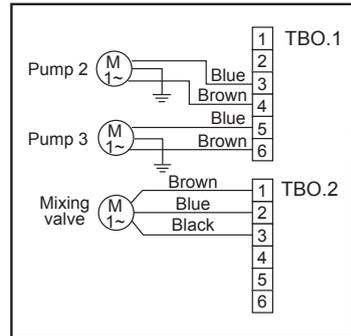

NOTE
 The power cable shall be covered with the conduit under the following condition.

- The users never touch the power cable inside the conduit.
- The conduit shall not be easily removed by the users.
- Do not damage the cable when installing it in the conduit.

DIP Switch settings of Cylinder unit (Hydrobox)

Setting the following DIP switches are necessary for 2 zone control. (See the installation manual of Cylinder unit (Hydrobox) for more information.)

DIP switch	Function	OFF	ON	Setting when using 2 zone kit
SW2-6	Mixing tank	WITHOUT Mixing tank	WITH Mixing tank	ON
SW2-7	2-zone temperature control	Inactive	Active *	ON

* Active only when SW3-6 is set to OFF.

Specifications

Model name	PAC-TZ01-E
Dimension	265mm × 356mm × 383mm
Weight	18kg
Power supply	230V/single phase/50Hz from Cylinder unit (Hydrobox)
Sound pressure level	28dB(A)
Sound power level	40dB(A)
Pump2, 3	Max. 70W/0.58A
	Max. head 7.5m ^{*1}
Mixing valve	5W
	Running time 90° 120s
Water flow rate range	Depend on outdoor unit

Note:

- Max. flow rate is 27.7L/min. If the flow rate exceeds 27.7L/min, pipes would be eroded.
- The water flow rate between the Cylinder unit (Hydrobox) and the 2 zone kit must be greater than the total flow rate of Zone1 and Zone2.

*1 Refer to the graph below and add any pumps if necessary.

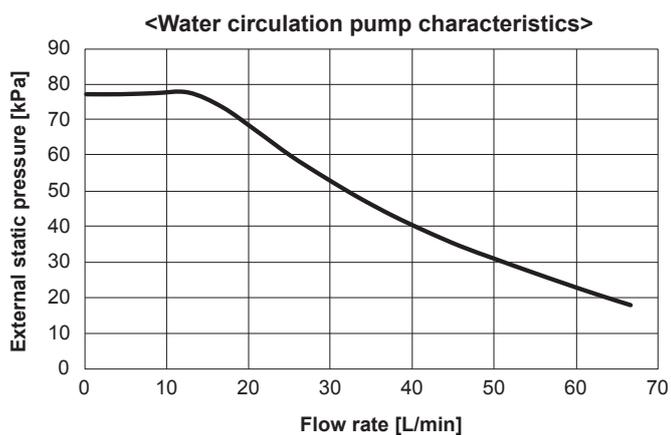



for a greener tomorrow

Eco Changes is the Mitsubishi Electric Group's environmental statement and expresses the Group's stance on environmental management. Through a wide range of businesses, we are helping contribute to the realization of a sustainable society.

mitsubishi electric corporation

HEAD OFFICE : TOKYO BUILDING, 2-7-3, MARUNOUCHI, CHIYODA-KU, TOKYO100-8310, JAPAN