



# GMV5 DC INVERTER VRF UNITS SERVICE MANUAL

TI/R410A/50-60Hz

# Contents

<b>Chapter 1 Introduction to Basic Features of Units.....</b>	<b>1</b>
1.1 Basic Operating Principle.....	1
1.2 Model list.....	2
1.3 Internal Piping Design of the Units .....	3
1.4 Basic Parameters of Unit.....	7
1.5 Electrical Parameters.....	10
1.6 Optional Accessories.....	14
1.7 Basic Requirement for Pipe Connection .....	15
1.8 Precautions on Refrigerant Leakage .....	18
1.9 Unit Operating Temperature.....	19
<b>Chapter 2 Installation.....</b>	<b>20</b>
1 Engineering Installation Preparation .....	20
1.1 Installation Safety .....	20
1.2 Importance of Installation Engineering.....	21
1.3 Cooperation Between Different Professions.....	23
1.4 Onsite Review of Design Drawing.....	25
1.5 Construction Organization Process .....	26
2 Material Selection.....	27
2.1 Requirement for Selecting Construction Materials .....	27
2.2 Requirement for Selecting Major Materials.....	28
3 Installation Space Requirement .....	30
3.1 Place Selection for Installing ODU .....	30
3.2 ODU Dimensions and Installation Hole Size.....	30
3.3 Installation Space Requirement for ODU.....	32
4 Requirements on Foundation Installation .....	39
4.1 ODU Foundation.....	39
4.2 ODU Fixing .....	39
4.3 Vibration Reduction for ODU .....	39
5 Piping Connection .....	41
5.1 Schematic Diagram of Piping Connection .....	41
5.2 Schematic Diagram of Piping Sequence .....	42
5.3 Allowable pipe length and drop height among indoor and outdoor units .....	44
5.4 Connection Pipe among Outdoor Modules.....	47
5.5 Fitting pipe between Outdoor Unit and the First Manifold.....	49
6 Pipe Installation and Insulation.....	55
6.1 Pipe Installation for the Cooling System .....	55
6.2 Pipe Installation for the Condensate Water System .....	64
6.3 Insulation System .....	68
7 Electric and Controller Installation.....	69
7.1 Precautions .....	69
7.2 Installation of the Power Cable .....	70
7.3 Installation of the Communication System.....	73
8 Vacuumization and Desiccation for the Refrigerant System.....	77
8.1 Air-tightness Test.....	77
8.2 Vacuumization and Desiccation for the System .....	78
9 Refrigerant Perfusion.....	79
9.1 Calculation Method for Perfusing Refrigerant .....	79
9.2 Method for Perfusing Refrigerant.....	80
<b>Chapter 3 Commissioning Operation.....</b>	<b>82</b>
1 Security Requirements .....	82
1.1 Precautions for Construction .....	82
1.2 Precautions for the Use of Refrigerants .....	82

---

<b>2 Introduction to Unit Functions</b> .....	83
2.1 System Function DIP Switch Settings.....	83
2.2 System Function Button Operations .....	89
<b>3 Commissioning Process</b> .....	105
3.1 Necessity of VRF Engineering Commissioning.....	105
3.2 Required Files and Tools for Engineering Commissioning.....	106
3.3 Engineering Commissioning Procedures .....	107
3.4 References for Proper Unit Operation Parameters .....	127
<b>Chapter 4 Maintenance</b> .....	<b>129</b>
1 Failure Code Table .....	129
2 Exception Analyzing and Troubleshooting .....	133
2.1 Form analyzing.....	133
2.2 Flowchart analyzing .....	153
3 Key Parts Maintenance .....	176
3.1 Cautions on Controller AP1 Replacement .....	176
3.2 Compressor Replacement and Cautions.....	181
3.3 Cautions on Compressor Drive Replacement.....	202
3.4 Assembling and Disassembling Key Parts of ODUs .....	205
3.5 Common Parameter Lists .....	216
3.6 Exploded Views and Spare Part List.....	223
<b>Chapter 5 Remote Control</b> .....	<b>235</b>
1 Engineering Debugger .....	235
1.1 Overview .....	235
1.2 System Networking .....	236
1.3 Hardware .....	237
1.4 Software Setup .....	240
1.5 Using Debugger .....	250
1.6 Software Debug .....	267
2 Remote Control.....	268
2.1 Major Functions .....	268
2.2 Terms and Definitions.....	268
2.3 Network Topology of Gree CAC Remote Monitoring System .....	268
2.4 Hardware .....	271
2.5 Software .....	285
2.6 Software Debug.....	298
2.7 Remote Monitoring System Debug .....	305
2.8 Troubleshooting .....	315

# Preface

This manual specifies safe operation requirements for GMV5 series VRF units from perspectives of engineering and installation, commissioning and maintenance, as well as basic principles and implementation methods. Professional operators must abide by relevant national (local) safety requirements and technical specifications set forth in this manual during operations; otherwise, the air conditioning system may fail or be damaged, and personnel safety accident may also occur.

## Chapter 1 Introduction to Basic Features of Units

### 1.1 Basic Operating Principle

Outdoor units of GMV5 VRF air conditioner can be implemented by combining multiple modules in parallel. Similarly, indoor units (IDUs) consist of multiple units connecting in parallel. The operating principle is as follows: When an IDU is operating in cooling mode, the outdoor unit (ODU) can correspondingly enable the outdoor module based on the operating load requirement of the IDU. The outdoor heat exchanger serves as a system condenser, and the heat exchangers of cooling IDUs are connected in parallel to serve as a system evaporator. The circulation of air supply and air return of the IDU is performed to adjust the indoor temperature and humidity. When an IDU is operating in heating mode, all four-way valves in the ODU module are switched into energized status. The outdoor heat exchange serves as the system evaporator, and the heat exchanger of the IDU serves as the system condenser. The circulation of air supply and air return of the IDU is performed to adjust the indoor temperature and humidity.



## 1.2 Model list

Model			Nominal Capacity	Power Supply	Appearance
Model name	Refrigerant	Product Code	kW	Ph, V, Hz	
GMV-224WM/B-X	R410A	CN851W1280	22.4	3, 380-415, 50/60	
GMV-280WM/B-X	R410A	CN851W1290	28.0	3, 380-415, 50/60	
GMV-335WM/B-X	R410A	CN851W1300	33.5	3, 380-415, 50/60	
GMV-400WM/B-X	R410A	CN851W1310	40.0	3, 380-415, 50/60	
GMV-450WM/B-X	R410A	CN851W1320	45.0	3, 380-415, 50/60	
GMV-504WM/B-X	R410A	CN851W1610	50.4	3, 380-415, 50/60	
GMV-560WM/B-X	R410A	CN851W1620	56.0	3, 380-415, 50/60	
GMV-615WM/B-X	R410A	CN851W1630	61.5	3, 380-415, 50/60	

# 1.3 Internal Piping Design of the Units

## 1.3.1 Piping Diagram of GMV-224WM/B-X, GMV-280WM/B-X, and GMV-335WM/B-X

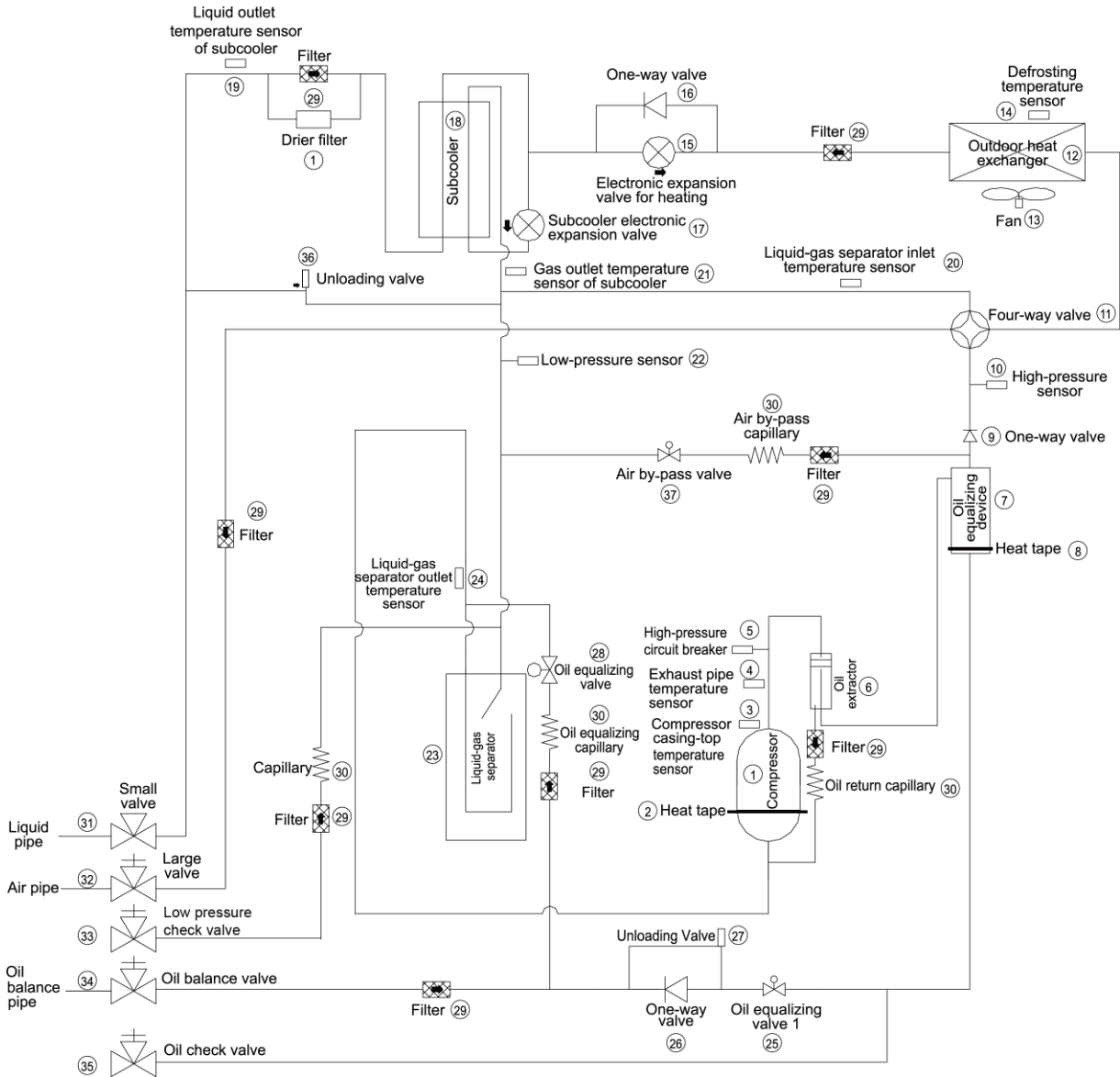

1.3.2 Piping Diagram of GMV-400WM/B-X and GMV-450WM/B-X

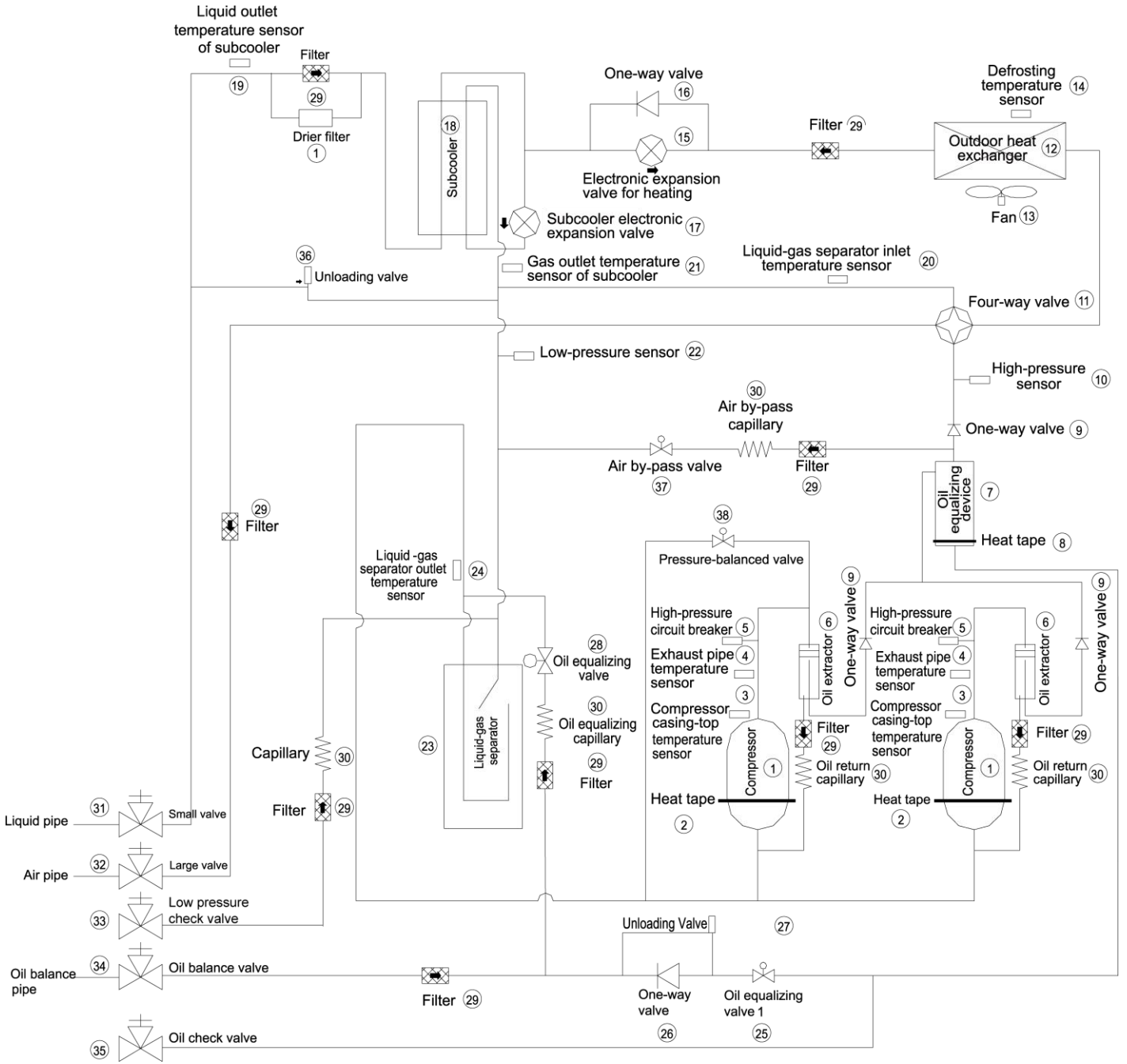

1.3.3 Piping Diagram of GMV-504WM/B-X 、 GMV-560WM/B-X and GMV-615WM/B-X

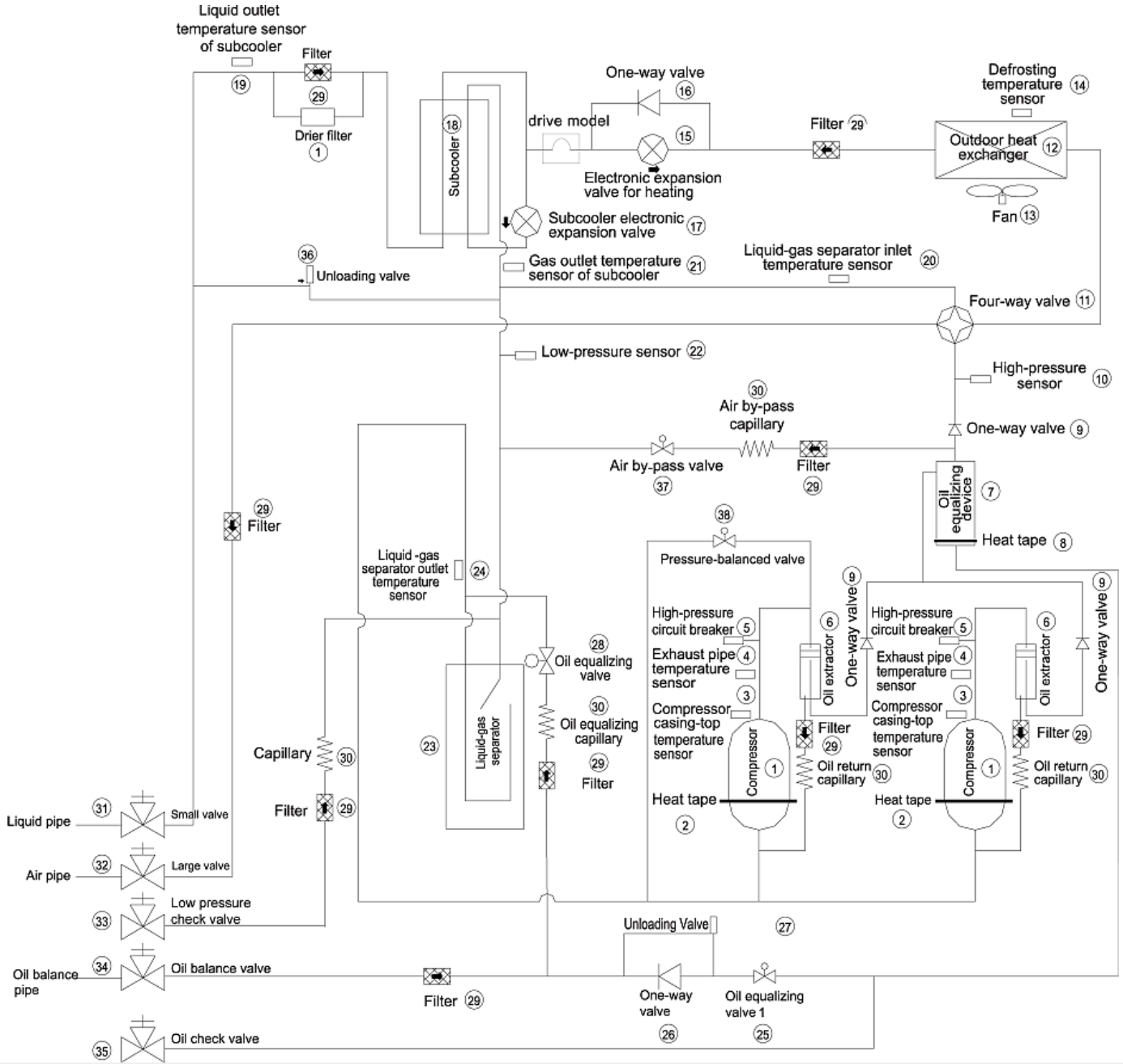

1.3.4 Names and Main Functions of Components

No.	Name	Main Function
1	Compressor	Adjusts its own rotational speed based on the actual requirement of the system to implement capacity control.
2	Compressor heat tape	Maintains a proper oil temperature in the compressor when the compressor is in standby status, ensuring the reliability during compressor startup.
3	Compressor casing-top temperature sensor	Detects a compressor's exhaust gas temperature for compressor control and protection.
4	Exhaust pipe temperature sensor of compressor	Detects a compressor's exhaust gas temperature for compressor control and protection.
5	High-pressure circuit breaker	Protects a compressor by sending feedback signal to stop the system when the compressor's discharge temperature exceeds the operating value of high-pressure circuit breaker.
6	Oil extractor	Separates the gas and oil in the system to ensure compressor reliability.

GMV5 DC INVERTER VRF UNITS SERVICE MANUAL

7	Oil equalizing device	Equalizes the oil for all modules in the case of excess oil in the current module when multiple modules are arranged in parallel, thus ensuring the system reliability.
8	Heat tape of oil equalizing device	Maintains a proper oil temperature in the compressor when the compressor is in standby status, ensuring the reliability of compressor startup.
9	One-way valve	Prevents high-pressure gas from entering the compressor and fast balances the suction pressure and discharge pressure in a compressor.
10	High-pressure sensor	Detects the high pressure value in the system in real time mode for compressor protection and other control functions.
11	Four-way valve	Used for the switching between the cooling and heating functions of system IDU.
12	Heat exchanger	Used for outdoor heat exchange.
13	Fan	Strengthens heat exchanging.
14	Defrosting temperature sensor	Used for defrosting detection.
15	Electronic expansion valve for heating	Controls refrigerant adjustment in heating mode.
16	One-way valve	Controls refrigerant flow direction.
17	Subcooler electronic expansion valve	Controls the degree of subcooling of tube refrigerant when the system is running in cooling mode, and reduces the capacity loss on pipes.
18	Subcooler	Controls the degree of subcooling of tube.
19	Liquid outlet temperature sensor of subcooler	Detects tube temperature.
20	Inlet temperature sensor of gas-liquid separator	Detects the inlet temperature of gas-liquid separator to prevent the system from running when the refrigerant flows back to the compressor.
21	Gas outlet temperature sensor of subcooler	Detects gas temperature of subcooler.
22	Low-pressure sensor	Detects system low pressure to avoid extra-low operating pressure.
23	Gas-liquid separator	Separate gas and liquid to prevent the system from running when the refrigerant flows back to the compressor.
24	Outlet temperature sensor of gas-liquid separator	Detects internal status of gas-liquid separator to further control the compressor suction performance.
25	Oil equalizing valve 1	Used for oil equalizing control among modules.
26	One-way valve	Used for oil equalizing control among modules and avoid reverse flow of oil.
27	Unloading valve	Avoids over-high pressure caused by pipeline blind spot.
28	Oil equalizing valve 2	Used for oil equalizing control among modules.
29	Filter	Prevents impurities from entering components and parts.
30	Capillary tube	Supports flow regulating and pressure reduction.
31	Liquid valve	Stop valve, closed when the unit is delivered from the factory and will be opened after installation.
32	Air valve	Stop valve, closed when the unit is delivered from the factory and will be opened after installation.
33	Low-pressure measurement valve	Detects the low pressure value or charges refrigerant during system running.
34	Oil balance valve	Stop valve, closed when the unit is delivered from the factory and will be opened after installation.
35	Oil check valve	Checks the quality of refrigerating machine oil of compressor during maintenance.
36	Unloading valve	Avoid over-high pressure caused by pipeline blind spot.
37	Air by-pass valve	Avoids extra-high or low operating pressure.
38	Pressure-balanced valve	Ensures success startup of compressor.

# 1.4 Basic Parameters of Unit

Model		GMV-224 WM/B-X	GMV-280 WM/B-X	GMV-335 WM/B-X	GMV-400 WM/B-X	GMV-450 WM/B-X	GMV-504 WM/B-X	GMV-560 WM/B-X	GMV-615 WM/B-X	
Refrigeration Capacity	HP	8	10	12	14	16	18	20	22	
Combination Mode	—	—	—	—	—	—	—	—	—	
Power Supply		380-415V 3N~ 50Hz/60Hz								
Rated Capacity	Cooling	kW	22.4	28	33.5	40	45	50.4	56	61.5
	Heating	kW	25	31.5	37.5	45	50	56.5	63	69
Dimensions (W x D x H)		mm	930 x 765 x 1605	930 x 765 x 1605	1340 x 765 x 1605	1340 x 765 x 1605	1340 x 765 x 1605	1340 x 765 x 1740	1340 x 765 x 1740	1340 x 765 x 1740
Tubing Dimensions	Liquid Pipe	mm	Φ9.52	Φ9.52	Φ12.7	Φ12.7	Φ12.7	Φ15.9	Φ15.9	Φ15.9
	Gas Pipe	mm	Φ19.05	Φ22.2	Φ25.4	Φ25.4	Φ28.6	Φ28.6	Φ28.6	Φ28.6
	Balance pipe	mm	Φ9.52	Φ9.52	Φ9.52	Φ9.52	Φ9.52	Φ9.52	Φ9.52	Φ9.52
Compressor refrigeration oil brand		-	FVC68D or FV-68H	FVC68D or FV-68H	FVC68D or FV-68H	FVC68D or FV-68H	FVC68D or FV-68H	FVC68D or FV-68H	FVC68D or FV-68H	FVC68D or FV-68H
oil charge	Totally	L	4.0	4.0	4.5	6.0	6.0	7.2	7.2	7.2
	Compressor	L	0.5	0.5	0.5	0.5x2	0.5x2	1.1x2	1.1x2	1.1x2
	Else	L	3.5	3.5	4.0	5.0	5.0	5.0	5.0	5.0
Weight		kg	225	225	285	360	360	360	385	385
Refrigerant	Name		R410A	R410A	R410A	R410A	R410A	R410A	R410A	R410A
	Built-in Filling Volume	kg	5.9	6.7	8.2	9.8	10.3	11.3	14.3	14.3

Model		GMV-680 WM/B-X	GMV-730 WM/B-X	GMV-785 WM/B-X	GMV-850 WM/B-X	GMV-900 WM/B-X	GMV-960 WM/B-X	GMV-1010 WM/B-X	GMV-1065 WM/B-X	
Refrigeration Capacity	HP	24	26	28	30	32	34	36	38	
Combination Mode	—	GMV-280 WM/B-X + GMV-400 WM/B-X	GMV-280 WM/B-X + GMV-450 WM/B-X	GMV-280 WM/B-X + GMV-504 WM/B-X	GMV-280 WM/B-X + GMV-560 WM/B-X	GMV-280 WM/B-X + GMV-615 WM/B-X	GMV-335 WM/B-X + GMV-615 WM/B-X	GMV-400W M/B-X + GMV-615W M/B-X	GMV-450W M/B-X + GMV-615W M/B-X	
Power Supply		380-415V 3N~ 50Hz/60Hz								
Rated Capacity	Cooling	kW	68	73	78.4	84	89.5	95	101.5	106.5
	Heating	kW	76.5	81.5	88	94.5	100.5	106.5	114	119
Dimensions (W x D x H)		mm	930 x 765 x 1605 + 1340 x 765 x 1605	930 x 765 x 1605 + 1340 x 765 x 1605	930x 765 x 1605 + 1340 x 765 x 1740	930x 765 x 1605 + 1340 x 765 x 1740	930 x 765 x 1605 + 1340 x 765 x 1740	1340 x 765 x 1605+ 1340 x 765 x 1740	1340 x 765 x 1605 + 1340 x 765 x 1740	1340 x 765 x 1605 + 1340 x 765 x 1740
Tubing Dimensions	Liquid Pipe	mm	Φ15.9	Φ19.05	Φ19.05	Φ19.05	Φ19.05	Φ19.05	Φ19.05	Φ19.05
	Air Pipe	mm	Φ28.6	Φ31.8	Φ31.8	Φ31.8	Φ31.8	Φ31.8	Φ38.1	Φ38.1
	Balance pipe	mm	Φ9.52	Φ9.52	Φ9.52	Φ9.52	Φ9.52	Φ9.52	Φ9.52	Φ9.52
Weight		kg	225+360	225+360	225+360	225+385	225+385	285+385	360+385	360+385
Refrigerant	Name		R410A	R410A	R410A	R410A	R410A	R410A	R410A	R410A
	Built-in Filling Volume	kg	6.7+9.8	6.7+10.3	6.7+11.3	6.7+14.3	6.7+14.3	8.2+14.3	9.8+14.3	10.3+14.3

**GMV5 DC INVERTER VRF UNITS SERVICE MANUAL**

Model			GMV-1130W M/B-X	GMV-1180W M/B-X	GMV-1235W M/B-X	GMV-1300W M/B-X	GMV-1350W M/B-X	GMV-1410W M/B-X	GMV-1460W M/B-X
Refrigeration Capacity	HP		40	42	44	46	48	50	52
Combination Mode	—		GMV-504WM/ B-X + GMV-615WM/ B-X	GMV-560WM/ B-X + GMV-615WM/ B-X	GMV-615WM/ B-X + GMV-615WM/ B-X	GMV-280WM/ B-X + GMV-450WM/ B-X + GMV-560WM/ B-X	GMV-280WM/ B-X + GMV-450WM/ B-X + GMV-615WM/ B-X	GMV-335WM/ B-X + GMV-450WM/ B-X + GMV-615WM/ B-X	GMV-280WM/ B-X + GMV-560WM/ B-X + GMV-615WM/ B-X
Power Supply			380-415V 3N~ 50Hz/60Hz						
Rated Capacity	Cooling	kW	111.9	117.5	123	129	134.5	140	145.5
	Heating	kW	125.5	132	138	144.5	150.5	156.5	163.5
Dimensions (W x D x H)	mm		1340 x 765 x 1740 + 1340 x 765 x 1740	1340 x 765 x 1740 + 1340 x 765 x 1740	1340 x 765 x 1740 + 1340 x 765 x 1740	930×765× 1605+1340 x 765 x 1605+1340× 765×1740	930×765 x 1605+1340 x 765 x 1605 +1340×765 ×1740	1340×765× 1605+1340× 765× 1605+1340× 765×1740	930×765× 1605+1340× 765× 1740+1340× 765×1740
Tubing Dimensions	Liquid Pipe	mm	Φ19.05	Φ19.05	Φ19.05	Φ19.05	Φ19.05	Φ19.05	Φ19.05
	Air Pipe	mm	Φ38.1	Φ38.1	Φ38.1	Φ38.1	Φ38.1	Φ41.3	Φ41.3
	Balance pipe	mm	Φ9.52	Φ9.52	Φ9.52	Φ9.52	Φ9.52	Φ9.52	Φ9.52
Weight	kg		360+385	385+385	385+385	225+360+3 85	225+360+3 85	285+360+38 5	225+385+3 85
Refrigerant	Name		R410A	R410A	R410A	R410A	R410A	R410A	R410A
	Built-in Filling Volume	kg	11.3+14.3	14.3+14.3	14.3+14.3	6.7+10.3+14.3	6.7+10.3+14.3	8.2+10.3+14.3	6.7+14.3+14.3

Model			GMV-1515W M/B-X	GMV-1580W M/B-X	GMV-1630W M/B-X	GMV-1685W M/B-X	GMV-1750W M/B-X	GMV-1800W M/B-X	
Refrigeration Capacity	HP		54	56	58	60	62	64	
Combination Mode	—		GMV-280WM/B -X + GMV-615WM/B -X + GMV-615WM/B -X	GMV-335WM/B -X + GMV-615WM/B -X + GMV-615WM/B -X	GMV-400WM/B -X + GMV-615WM/B -X + GMV-615WM/B -X	GMV-450WM/B -X + GMV-615WM/B -X + GMV-615WM/B -X	GMV-504WM/B -X + GMV-615WM/B -X + GMV-615WM/B -X	GMV-560WM/B -X + GMV-615WM/B -X + GMV-615WM/B -X	
Power Supply			380-415V 3N~ 50Hz/60Hz						
Rated Capacity	Cooling	kW	151	156.5	163	168	173.4	179	
	Heating	kW	169.5	175.5	183	188	194.5	201	
Dimensions (W x D x H)	mm		930×765× 1605+1340× 765× 1740+1340× 765×1740	1340×765× 1605+1340× 765× 1740+1340× 765×1740	1340×765× 1605+1340× 765× 1740+1340× 765×1740	1340×765× 1605+1340× 765× 1740+1340× 765×1740	1340×765× 1740+1340× 765× 1740+1340× 765×1740	1340×765× 1740+1340× 765× 1740+1340× 765×1740	
Tubing Dimensions	Liquid Pipe	mm	Φ19.05	Φ19.05	Φ19.05	Φ19.05	Φ19.05	Φ19.05	
	Air Pipe	mm	Φ41.3	Φ41.3	Φ41.3	Φ41.3	Φ41.3	Φ41.3	
	Balance pipe	mm	Φ9.52	Φ9.52	Φ9.52	Φ9.52	Φ9.52	Φ9.52	
Weight	kg		225+385+385	285+385+385	360+385+385	360+385+385	360+385+385	385+385+385	
Refrigerant	Name		R410A	R410A	R410A	R410A	R410A	R410A	
	Built-in Filling Volume	kg	6.7+14.3+14.3	8.2+14.3+14.3	9.8+14.3+14.3	10.3+14.3+14.3	11.3+14.3+14.3	14.3+14.3+14.3	

**GMV5 DC INVERTER VRF UNITS SERVICE MANUAL**

Model		GMV-1854W M/B-X	GMV-1908W M/B-X	GMV-1962W M/B-X	GMV-2016W M/B-X	GMV-2072W M/B-X	GMV-2128W M/B-X	
Refrigeration Capacity	HP	66	68	70	72	74	76	
Combination Mode	—	GMV-615WM/B -X +GMV-615WM/ B-X +GMV-615WM/ B-X	GMV-280WM/B -X+ GMV-450WM/B -X +GMV-560WM/ B-X +GMV-615WM/ B-X	GMV-280WM/B -X+ GMV-504WM/B -X +GMV-560WM/ B-X +GMV-615WM/ B-X	GMV-280WM/B -X+ GMV-560WM/B -X +GMV-560WM/ B-X +GMV-615WM/ B-X	GMV-280WM/B -X+ GMV-560WM/B -X +GMV-615WM/ B-X +GMV-615WM/ B-X	GMV-280WM/B -X+ GMV-615WM/B -X +GMV-615WM/ B-X +GMV-615WM/ B-X	
Power Supply		380-415V 3N~ 50Hz/60Hz						
Rated Capacity	Cooling	kW	184.5	190.5	195.9	201.5	207	212.5
	Heating	kW	207	213.5	220	226.5	232.5	238.5
Dimensions (W x D x H)		mm	1340×765× 1740+1340× 765× 1740+1340× 765×1740	930×765× 1605+1340× 765×1605 +1340×765× 1740+1340× 765×1740	930×765× 1605+1340× 765×1740 +1340×765× 1740+1340× 765×1740	930×765× 1605+1340× 765×1740 +1340×765× 1740+1340× 765×1740	930×765× 1605+1340× 765×1740 +1340×765× 1740+1340× 765×1740	930×765× 1605+1340× 765×1740 +1340×765× 1740+1340× 765×1740
Tubing Dimensions	Liquid Pipe	mm	Φ19.05	Φ22.2	Φ22.2	Φ22.2	Φ22.2	Φ22.2
	Air Pipe	mm	Φ41.3	Φ44.5	Φ44.5	Φ44.5	Φ44.5	Φ44.5
	Balance pipe	mm	Φ9.52	Φ9.52	Φ9.52	Φ9.52	Φ9.52	Φ9.52
Weight		kg	385+385+385	225+360+385 +385	225+360+385 +385	225+385+385 +385	225+385+385 +385	225+385+385 +385
Refrigerant	Name		R410A	R410A	R410A	R410A	R410A	R410A
	Built-in Filling Volume	kg	14.3+14.3+14.3	6.7+10.3+14.3+1 4.3	6.7+11.3+14.3+1 4.3	6.7+14.3+14.3+1 4.3	6.7+14.3+14.3+1 4.3	6.7+14.3+14.3+1 4.3

Model		GMV-2184W M/B-X	GMV-2240W M/B-X	GMV-2295W M/B-X	GMV-2350W M/B-X	GMV-2405W M/B-X	GMV-2460W M/B-X	
Refrigeration Capacity	HP	78	80	82	84	86	88	
Combination Mode	—	GMV-335WM/B -X+ GMV-615WM/B -X +GMV-615WM/ B-X +GMV-615WM/ B-X	GMV-400WM/B -X+ GMV-615WM/B -X +GMV-615WM/ B-X +GMV-615WM/ B-X	GMV-450WM/B -X+ GMV-615WM/B -X +GMV-615WM/ B-X +GMV-615WM/ B-X	GMV-504WM/B -X+ GMV-615WM/B -X +GMV-615WM/ B-X +GMV-615WM/ B-X	GMV-560WM/B -X+ GMV-615WM/B -X +GMV-615WM/ B-X +GMV-615WM/ B-X	GMV-615WM/B -X+ GMV-615WM/B -X +GMV-615WM/ B-X +GMV-615WM/ B-X	
Power Supply		380-415V 3N~ 50Hz/60Hz						
Rated Capacity	Cooling	kW	218	224.5	229.5	234.9	240.5	246
	Heating	kW	244.5	252	257	263.5	270	276
Dimensions (W x D x H)		mm	1340×765× 1605+1340× 765×1740 +1340×765× 1740+1340× 765×1740	1340×765× 1605+1340× 765×1740 +1340×765× 1740+1340× 765×1740	1340×765× 1605+1340× 765×1740 +1340×765× 1740+1340× 765×1740	1340×765× 1740+1340× 765×1740 +1340×765× 1740+1340× 765×1740	1340×765× 1740+1340× 765×1740 +1340×765× 1740+1340× 765×1740	1340×765× 1740+1340× 765×1740 +1340×765× 1740+1340× 765×1740
Tubing Dimensions	Liquid Pipe	mm	Φ22.2	Φ22.2	Φ22.2	Φ22.2	Φ22.2	Φ22.2
	Air Pipe	mm	Φ44.5	Φ44.5	Φ44.5	Φ44.5	Φ44.5	Φ44.5
	Balance pipe	mm	Φ9.52	Φ9.52	Φ9.52	Φ9.52	Φ9.52	Φ9.52
Weight		kg	285+385+385 +385	360+385+385 +385	360+385+385 +385	360+385+385 +385	385+385+385 +385	385+385+385 +385
Refrigerant	Name		R410A	R410A	R410A	R410A	R410A	R410A
	Built-in Filling Volume	kg	8.2+14.3+14.3+1 4.3	9.8+14.3+14.3+1 4.3	10.3+14.3+14.3+ 14.3	11.3+14.3+14.3+ 14.3	14.3+14.3+14.3+ 14.3	14.3+14.3+14.3+ 14.3

**Note:**

A combination model is not allowed to be combined with the outdoor units belonging to different series.



# 1.5 Electrical Parameters

## 15.1 Power Cable Wire Gauge and Circuit Breaker Selection

Model	Basic models	Circuit breaker capacity (A)	Circuit breaker capacity for combined units (A)	Wire size of power supply (mm <sup>2</sup> )	Wire size of combined unit (mm <sup>2</sup> )
GMV-224WM/B-X	GMV-224WM/B-X	20	20	2.5	2.5×5
GMV-280WM/B-X	GMV-280WM/B-X	25	25	2.5	2.5×5
GMV-335WM/B-X	GMV-335WM/B-X	32	32	4.0	4.0×5
GMV-400WM/B-X	GMV-400WM/B-X	40	40	6.0	6.0×5
GMV-450WM/B-X	GMV-450WM/B-X	40	40	6.0	6.0×5
GMV-504WM/B-X	GMV-504WM/B-X	50	50	10	10×5
GMV-560WM/B-X	GMV-560WM/B-X	63	63	10	10×5
GMV-615WM/B-X	GMV-615WM/B-X	63	63	10	10×5
GMV-680WM/B-X	280+400	63	25 + 40	2.5 + 6.0	2.5×5 + 6.0×5
GMV-730WM/B-X	280+450	63	25 + 40	2.5 + 6.0	2.5×5 + 6.0×5
GMV-785WM/B-X	280+504	80	25 + 50	2.5 + 10	2.5×5 + 10×5
GMV-850WM/B-X	280+560	80	25 + 63	2.5 + 10	2.5×5 + 10×5
GMV-900WM/B-X	280+615	80	25 + 63	2.5 + 10	2.5×5 + 10×5
GMV-950WM/B-X	335+615	80	32 + 63	4.0 + 10	4.0×5 + 10×5
GMV-1010WM/B-X	400+615	100	40 + 63	6.0 + 10	6.0×5 + 10×5
GMV-1065WM/B-X	450+615	100	40 + 63	6.0 + 10	6.0×5 + 10×5
GMV-1130WM/B-X	504+615	125	50 + 63	10 + 10	10×5 + 10×5
GMV-1180WM/B-X	560+615	125	63 + 63	10 + 10	10×5 + 10×5
GMV-1235WM/B-X	615+615	125	63 + 63	10 + 10	10×5 + 10×5
GMV-1300WM/B-X	280+450+560	125	25 + 40 + 63	2.5 + 6.0 + 10	2.5×5 + 6.0×5 + 10×5
GMV-1350WM/B-X	280+450+615	125	25 + 40 + 63	2.5 + 6.0 + 10	2.5×5 + 6.0×5 + 10×5
GMV-1405WM/B-X	335+450+615	125	32 + 40 + 63	4.0 + 6.0 + 10	4.0×5 + 6.0×5 + 10×5
GMV-1456WM/B-X	280+560+615	160	25 + 63 + 63	2.5 + 10 + 10	2.5×5 + 10×5 + 10×5
GMV-1512WM/B-X	280+615+615	160	25 + 63 + 63	2.5 + 10 + 10	2.5×5 + 10×5 + 10×5
GMV-1570WM/B-X	335+615+615	160	32 + 63 + 63	4.0 + 10 + 10	4.0×5 + 10×5 + 10×5
GMV-1650WM/B-X	400+615+615	160	40 + 63 + 63	6.0 + 10 + 10	6.0×5 + 10×5 + 10×5
GMV-1700WM/B-X	450+615+615	160	40 + 63 + 63	6.0 + 10 + 10	6.0×5 + 10×5 + 10×5
GMV-1750WM/B-X	504+615+615	160	50 + 63 + 63	10 + 10 + 10	10×5 + 10×5 + 10×5
GMV-1800WM/B-X	560+615+615	180	63 + 63 + 63	10 + 10 + 10	10×5 + 10×5 + 10×5
GMV-1854WM/B-X	615+615+615	180	63+63+63	10+10+10	10×5+10×5+10×5
GMV-1908WM/B-X	280+450+560+615	180	25+40+63+63	2.5+6.0+10+10	2.5×5+6.0×5+10×5+10×5

GMV5 DC INVERTER VRF UNITS SERVICE MANUAL

Model	Basic models	Circuit breaker capacity (A)	Circuit breaker capacity for combined units (A)	Wire size of power supply (mm <sup>2</sup> )	Wire size of combined unit (mm <sup>2</sup> )
GMV-1962WM/B-X	280+504+560+615	180	25+50+63+63	2.5+10+10+10	2.5×5+10×5+10×5+10×5
GMV-2016WM/B-X	280+560+560+615	200	25+63+63+63	2.5+10+10+10	2.5×5+10×5+10×5+10×5
GMV-2072WM/B-X	280+ 560+615+615	200	25+63+63+63	2.5+10+10+10	2.5×5+10×5+10×5+10×5
GMV-2128WM/B-X	280+615+615+615	200	25+63+63+63	2.5+10+10+10	2.5×5+10×5+10×5+10×5
GMV-2184WM/B-X	335+615+615+ 615	200	32+63+63+63	4.0+10+10+10	4.0×5+10×5+10×5+10×5
GMV-2240WM/B-X	400+615+615+615	200	40+63+63+63	6.0+10+10+10	6.0×5+10×5+10×5+10×5
GMV-2295WM/B-X	450+615+615+615	225	40+63+63+63	6.0+10+10+10	6.0×5+10×5+10×5+10×5
GMV-2350WM/B-X	504+615+615+615	225	50+63+63+63	10+10+10+10	10×5+10×5+10×5+10×5
GMV-2405WM/B-X	560+615+615+615	225	63+63+63+63	10+10+10+10	10×5+10×5+10×5+10×5
GMV-2460WM/B-X	615+615+615+615	225	63+63+63+63	10+10+10+10	10×5+10×5+10×5+10×5

Note:

- ① The circuit breaker and power cable specifications are selected based on the maximum power (maximum current) of the units.
- ② Specification of power cord is based on the working condition where ambient temperature is 40℃ and multi-core copper cable (working temperature is 90℃) is lying on the surface of slot (IEC 60245). If working condition changes, please adjust the specification according to standard IEC 60245. Power cord used for outdoor unit should not be below standard 60245 IEC57.
- ③ Only copper conductor cable can be used.
- ④ The sectional area of a wire is applicable for a distance range of up to 15 m. If the distance is greater than 15 m, increase the sectional area of the wire correspondingly to prevent the wire from being burned due to overload current and to avoid fire.
- ⑤ The circuit breaker specifications are obtained under the conditions that the ambient temperature is 40℃ when the circuit breaker is working. In different applications, adjust the specifications based on the circuit breaker manual.
- ⑥ The circuit breaker must support magnetic release and thermal release at the same time to protect the system from short circuit and overload.

1.5.2 Circuit Diagram

Circuit diagram of GMV-224WM/B-X and GMV-280WM/B-X

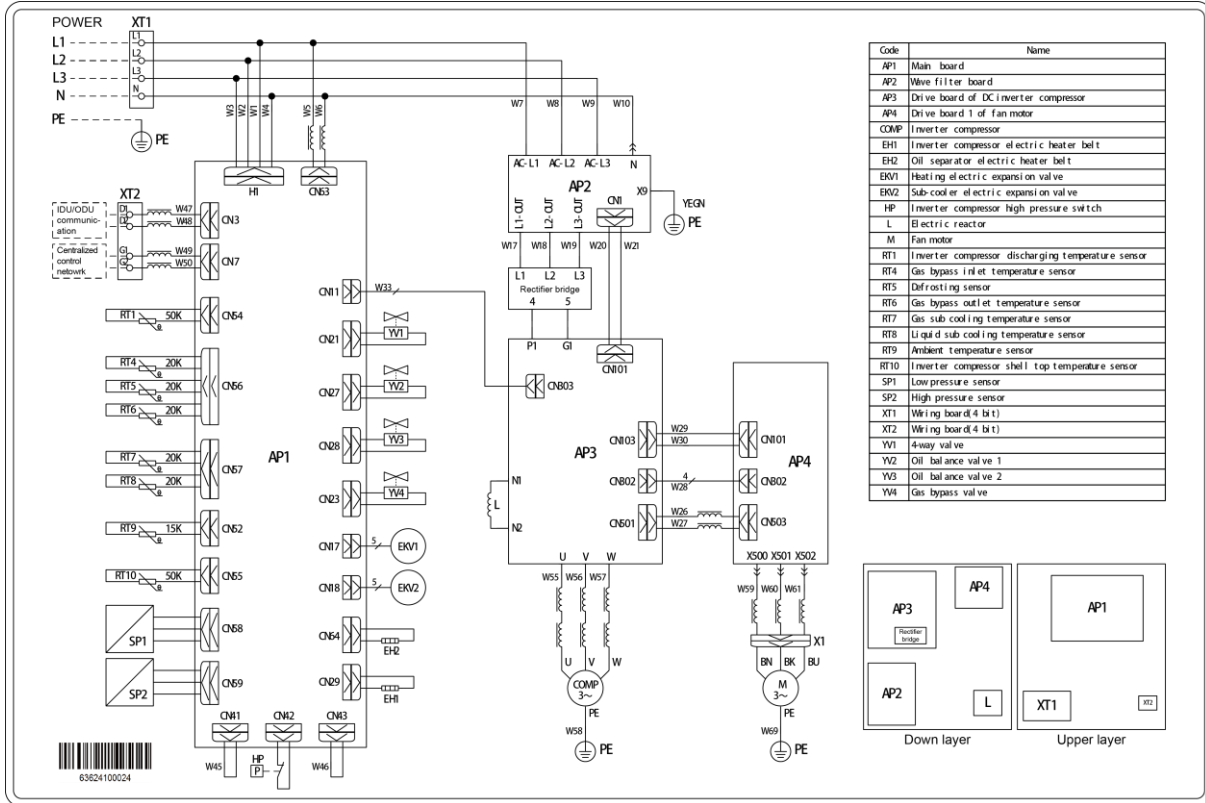

Circuit diagram of GMV-335WM/B-X

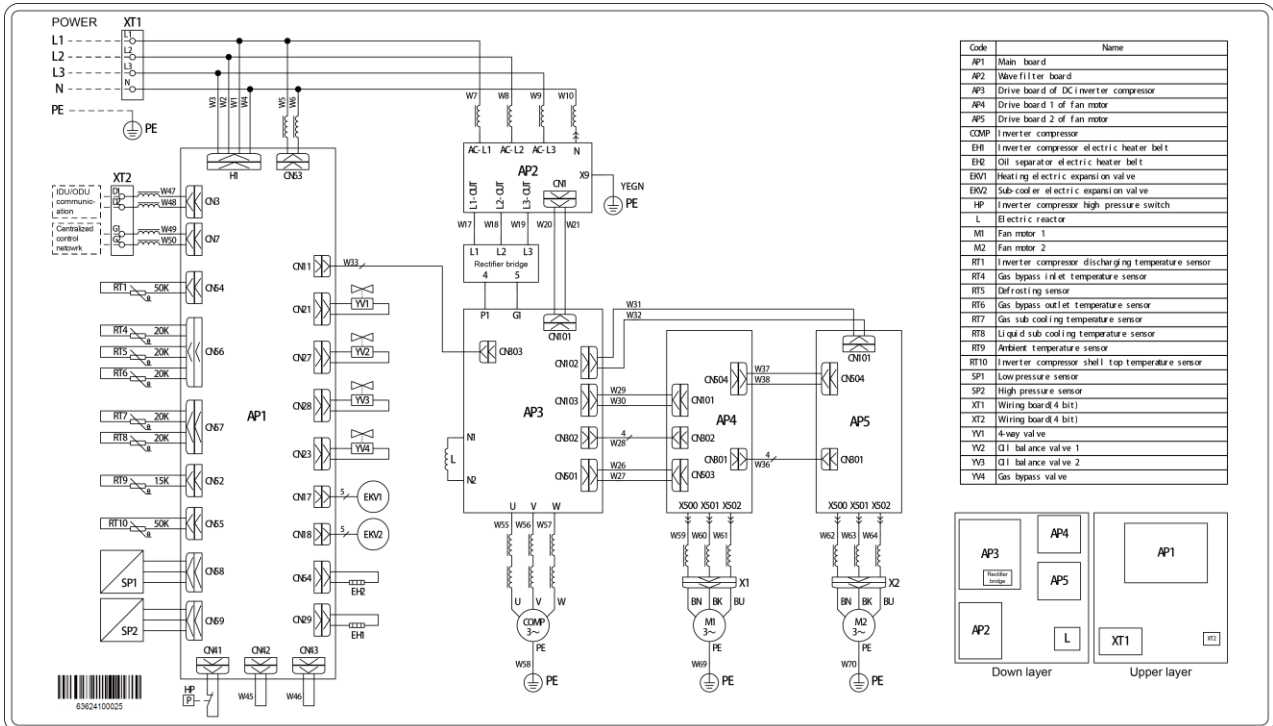

# GMV5 DC INVERTER VRF UNITS SERVICE MANUAL

## Circuit diagram of GMV-400WM/B-X and GMV-450WM/B-X

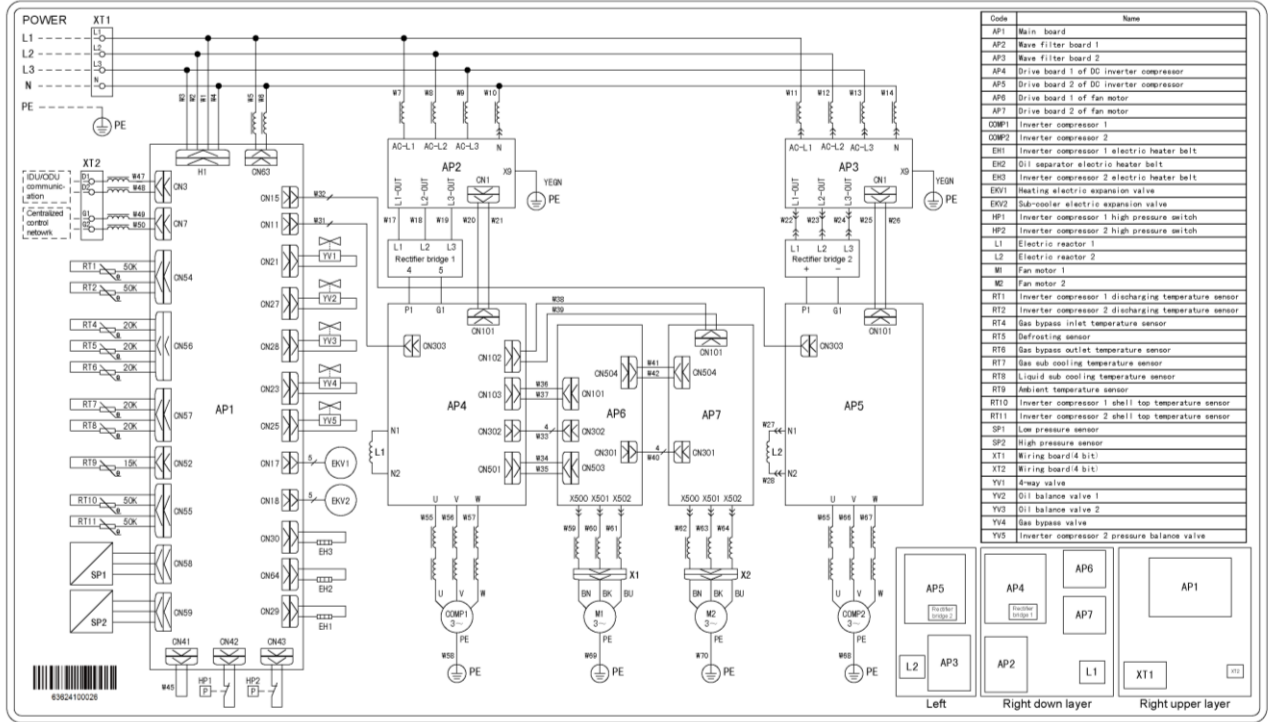

## Circuit diagram of GMV-504WM/B-X, GMV-560WM/B-X and GMV-615WM/B-X

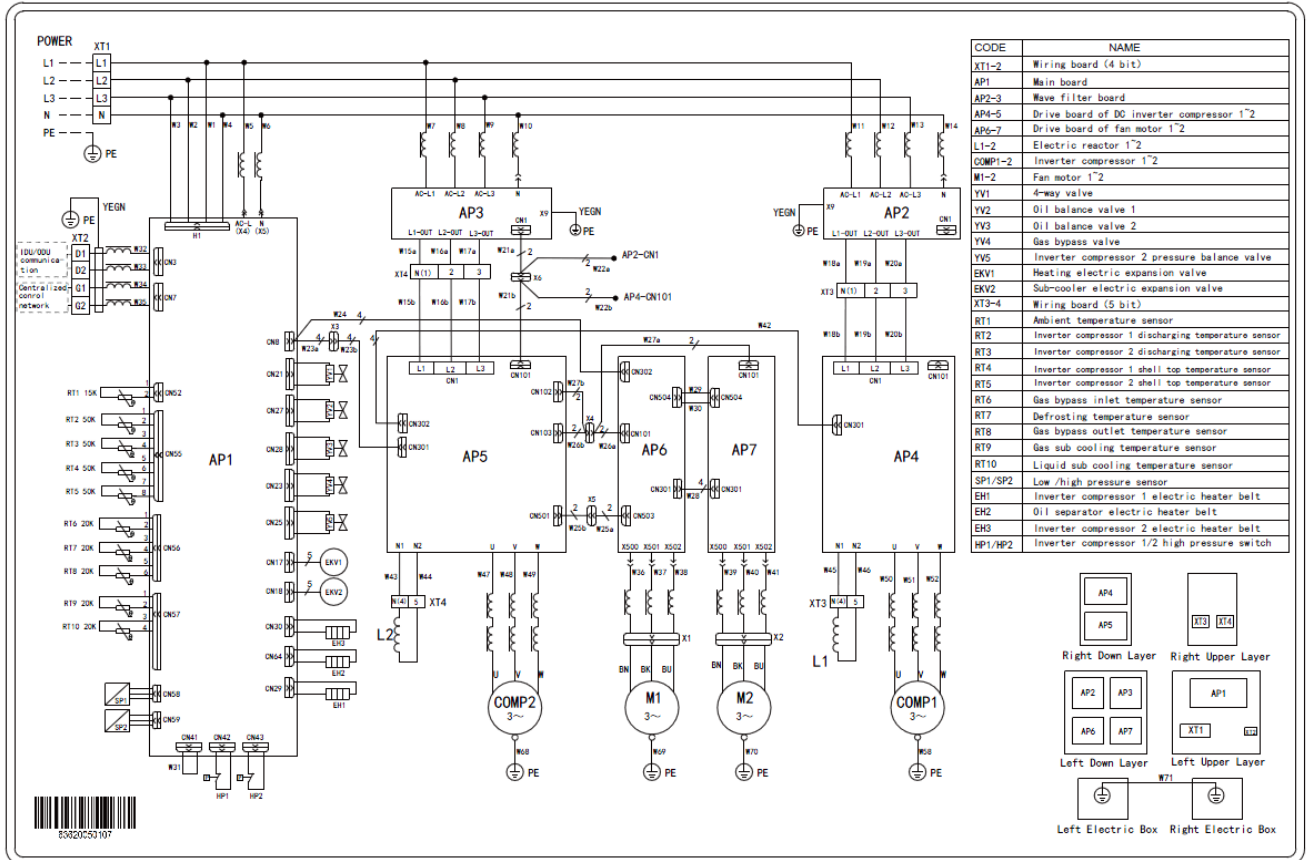

## 1.6 Optional Accessories

GMV5 series VRF units support the following optional accessories:

		Model	Remarks
Manifold	Outdoor unit	ML01/A	For the model selection method, see the part of pipeline selection.
	Indoor unit	FQ01A/A, FQ01B/A, FQ02/A, FQ03/A, FQ04/A	
Remote receiving LED panel		JS05	Applicable to the air duct-type indoor unit
Remote controller		YAP1F	Dct-type indoor unit Otional (Wall-Mounted indoor unit Standard)
Remote controller for debugging		YV1L1	With the debugging function, used to set functions of the indoor unit
Classic wired controller		Wired controller XK46	Applicable to the air Cassette, Floor Ceiling, Wall-Mounted indoor unit Otional (duct-type indoor unit Standard)
Wired controller		Wired controller XK79	With the access control function
Wired controller		Wired controller XK86	
Colour screen wired controller		Wired controller XK55	
Centralized controller		CE52-24/F(C)	
Smart zone controller		CE53-24/F(C)	
E-Smart Zone ontroller		CE54-24/F(C)	
Debugging software		DE40-33/A(C)	Applicable to the unit of CAN bus communication technology
Remote monitoring system	Software	FC31-00/AD(BM)	Applicable to the unit of CAN bus communication technology
	Optoelectronic isolated converter	GD02	
	MODbus gateway	ME30-24/E4(M)	

Note: Contact local sales company for optional accessories.

# 1.7 Basic Requirement for Pipe Connection

1.7.1 Outdoor units adopt the modular combination design of individual cooling system, that is, units are connected by using pipes in parallel during installation. The tubing system used among modules includes air pipes, liquid pipes and oil equalizing pipes.

GMV-224WM/B-X and GMV-280WM/B-X

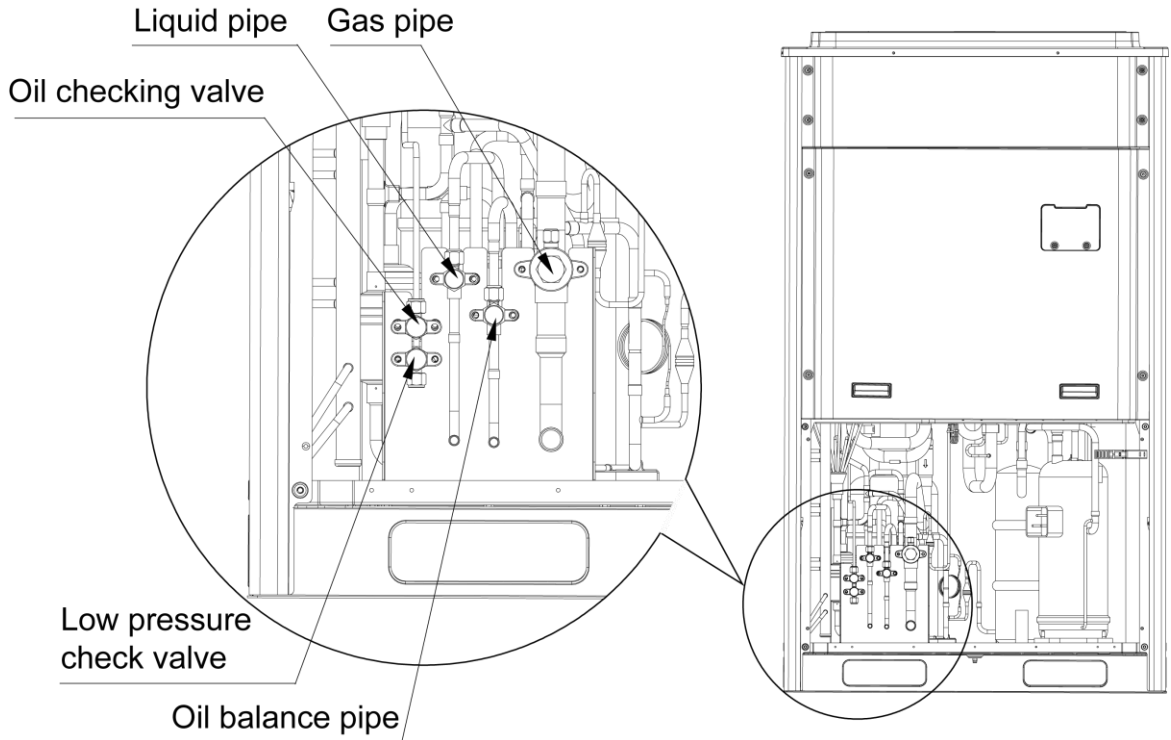

GMV-335WM/B-X, GMV-400WM/B-X and GMV-450WM/B-X

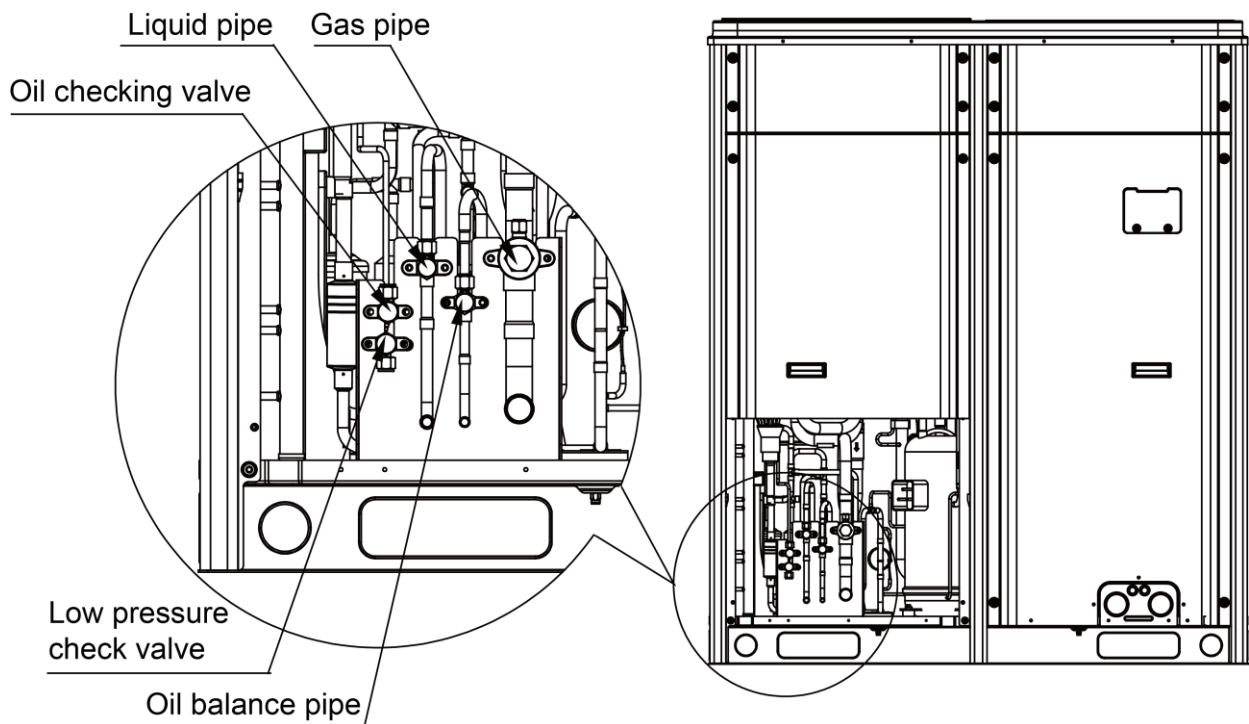

GMV-504WM/B-X, GMV-560WM/B-X and GMV-615WM/B-X

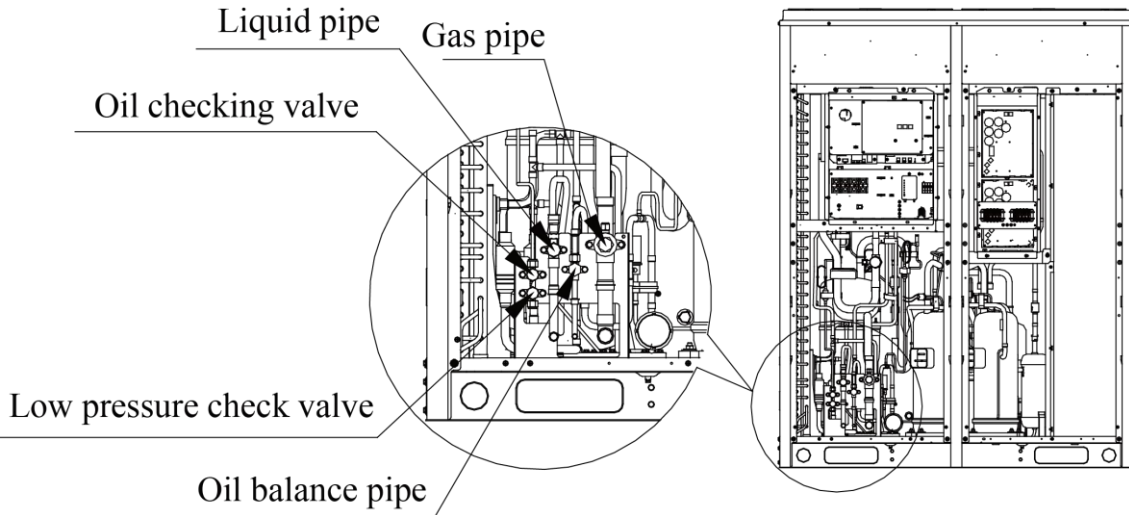

Note:

- ① Functions of oil check valve: During after-sale maintenance, the oil check valve can be used to extract lubricating oil samples, which are further detected to analyze the oil quality in the system. The oil check valve can also serve as the inlet for lubricating oil charging. Stop the system for at least 12 hours before the extracting of lubricating oil from the system; otherwise, overheat oil may burn the operator.
- ② Functions of low-pressure check valve: It is mainly used for low pressure detection of the system and refrigerant charging during after-sale maintenance.

Pipe connection diagram of outdoor modules

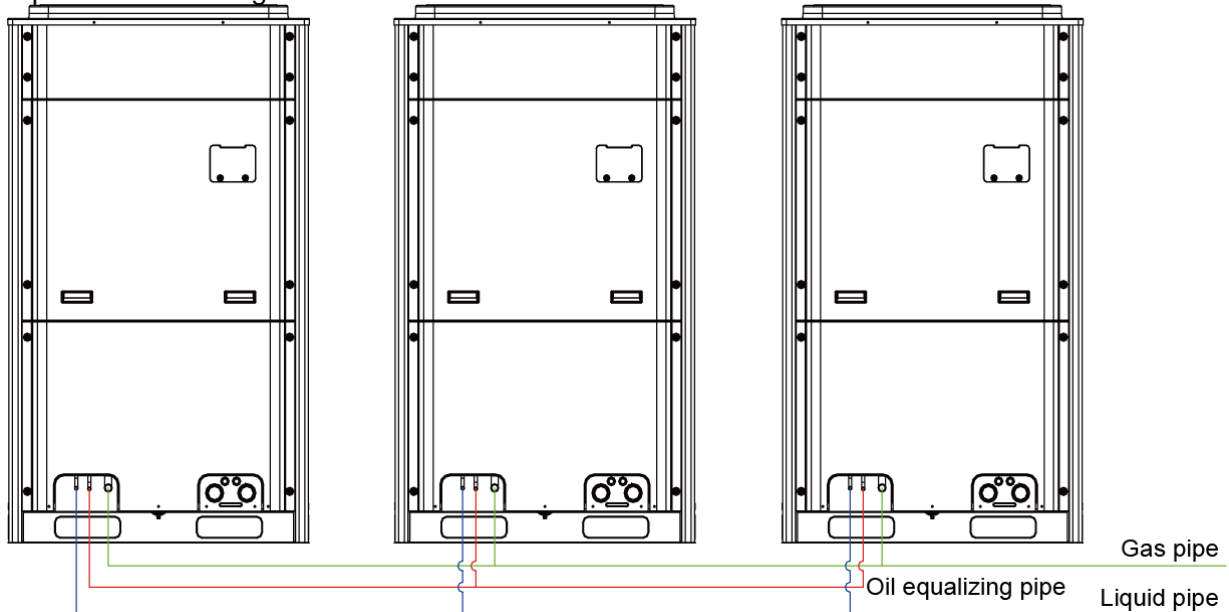

**1.7.2 Each ODU system can be connected to multiple IDUs. Detailed information about the number of units to be connected and capacity ranges is shown in the following table:**

ODU model	Max number of connectable IDU (unit)	Capacity Range of Connected IDU (kW)	
		Minimum Capacity	Maximum Capacity
GMV-224WM/B-X	13	11.2	30.2
GMV-280WM/B-X	16	14.0	37.8
GMV-335WM/B-X	19	16.8	45.2
GMV-400WM/B-X	23	20.0	54.0
GMV-450WM/B-X	26	22.5	60.8
GMV-504WM/B-X	29	25.2	68.0

GMV5 DC INVERTER VRF UNITS SERVICE MANUAL

GMV-560WM/B-X	33	28.0	75.6
GMV-615WM/B-X	36	30.8	83.0
GMV-680WM/B-X	39	34.0	91.8
GMV-730WM/B-X	43	36.5	98.6
GMV-785WM/B-X	46	39.3	106.0
GMV-850WM/B-X	50	42.5	114.8
GMV-900WM/B-X	53	45.0	121.5
GMV-960WM/B-X	56	48.0	129.6
GMV-1010WM/B-X	59	50.5	136.4
GMV-1065WM/B-X	63	53.5	144.5
GMV-1130WM/B-X	64	56.5	152.6
GMV-1180WM/B-X	64	59.0	159.3
GMV-1235WM/B-X	64	62.5	168.8
GMV-1300WM/B-X	64	65.0	175.5
GMV-1350WM/B-X	64	67.5	182.3
GMV-1410WM/B-X	66	70.5	190.4
GMV-1460WM/B-X	69	73.0	197.1
GMV-1515WM/B-X	71	75.8	204.5
GMV-1580WM/B-X	74	79.0	213.3
GMV-1630WM/B-X	77	81.5	220.0
GMV-1685WM/B-X	80	85.0	229.5
GMV-1750WM/B-X	80	87.5	236.3
GMV-1800WM/B-X	80	90.0	243.0
GMV-1854WM/B-X	80	92.2	249
GMV-1908WM/B-X	80	95.4	257.5
GMV-1962WM/B-X	80	98.1	264.8
GMV-2016WM/B-X	80	100.8	272.1
GMV-2072WM/B-X	80	103.6	279.7
GMV-2128WM/B-X	80	106.4	287.2
GMV-2184WM/B-X	80	109.2	294.8
GMV-2240WM/B-X	80	112.0	302.4
GMV-2295WM/B-X	80	114.7	309.8
GMV-2350WM/B-X	80	117.5	317.9
GMV-2405WM/B-X	80	120.2	324.6
GMV-2460WM/B-X	80	123.0	332.1



## 1.8 Precautions on Refrigerant Leakage

Personnel related to air conditioning engineering design and installation operators must abide by the safety requirement for preventing refrigerant leakage specified in local laws and regulations. If such safety requirement is unavailable in local documents, the design and operation must be implemented based on the following principles: GMV5 series VRF units adopt the R410A refrigerant, which is nonflammable and nontoxic. However, the space for refrigerant leakage must be sufficient to ensure that the refrigerant concentration does not exceed that specified in the safety requirement; otherwise, people involved can be stifled by the refrigerant.

The maximum refrigerant charge and maximum refrigerant concentration in the system are calculated directly based on the size of the air conditioning space. The unit of refrigerant concentration is  $1 \text{ kg/m}^3$ .

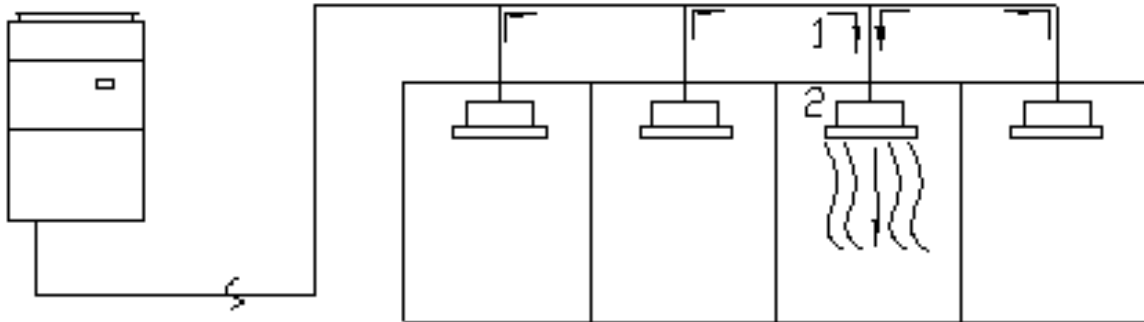

- 1) Flow direction of refrigerant leakage.
- 2) Room for refrigerant leakage. Since the concentration of refrigerant is greater than that of air, pay attention to the spaces where the refrigerant may residue, for example, the basement.

Method for calculating the maximum concentration of refrigerant:

- (1) Calculate the refrigerant charge quantity of each system.

Charge quantity of an ODU upon delivery (for the system consisting of multiple modules in parallel, the accumulative charge quantity of modules upon delivery is used) + Onsite charge quantity = Total refrigerant charge quantity in the system (kg)

- (2) Calculate the volume of maximum air conditioning space ( $\text{m}^3$ ).

Volume of air conditioning space ( $\text{m}^3$ ) = Length x Width x Height

Note: The length, width and height here refer to the effective length, width and height of the indoor space.

- (3) Calculate the maximum refrigerant concentration of the refrigeration system.

(Total refrigerant quantity of the system/Minimum volume of air conditioning space)  $\leq$  Maximum supported concentration ( $\text{kg/m}^3$ )

Note: If the maximum supported refrigerant concentration is not available in relevant local standard, use  $0.3 \text{ kg/m}^3$  as the maximum supported refrigerant concentration.

- (4) If the maximum refrigerant concentration exceeds the allowed threshold, the refrigeration system must be redesigned. In this case, separate the refrigeration system into multiple small-capacity refrigeration systems, or contact local Gree sales company.

## 1.9 Unit Operating Temperature

Cooling	-5°C~52°C
Heating	-20°C~24°C

In the case of a full fresh air conditioning IDU, the unit operating temperature is as follows:

Cooling	16°C~45°C
Heating	-7°C~16°C

Note: Out of the working Temperature Range may damage this products and will invalidate the warranty.

## **Chapter 2 Installation**

# **1 Engineering Installation Preparation**

## **1.1 Installation Safety**

Personnel and property safety are highly concerned during the entire installation process. Installation implementation must abide by relevant national safety regulations to ensure personnel and property safety.

All personnel involved in the installation must attend safety education courses and pass corresponding safety examinations before installation. Only qualified personnel can attend the installation. Relevant personnel must be held responsible for any violation of the regulation.

## 1.2 Importance of Installation Engineering

VRF air conditioning systems use refrigerant, instead of other agent, to directly evaporate to carry out the system heat. High level of pipe cleanness and dryness is required in the system. Since various pipes need to be prepared and laid out onsite, carelessness or maloperation during installation may leave impurities, water, or dust inside refrigerant pipes. If the design fails to meet the requirement, various problems may occur in the system or even lead to system breakdown.

Problems that usually occur during installation are as follows:

No.	Installation Problem	Possible Consequence
1	Dust or impurities enter into the refrigeration system.	Pipes are more likely to be blocked; air conditioning performance is reduced; compressor wear is increased or even hinder the normal operation of the system and burn the compressor.
2	Nitrogen is not filled into the refrigerant pipe or insufficient Nitrogen is filled before welding.	Pipes are more likely to be blocked; air conditioning performance is reduced; compressor wear is increased or even hinder the normal operation of the system and burn the compressor.
3	The vacuum degree in the refrigerant pipe is insufficient.	The refrigeration performance is reduced. The system fails to keep normal operation due to frequent protection measures. When the problem getting serious, compressor and other major components can be damaged.
4	Water enters into the refrigeration system.	Copper plating may appear on the compressor and reduce the compressor efficiency with abnormal noise generated; failures may occur in the system due to ice plug.
5	The refrigerant pipe specifications do not meet the configuration requirements.	Smaller configuration specifications can increase the system pipe resistance and affect the cooling performance; larger configuration specifications are waste of materials and can also reduce the cooling performance.
6	Refrigerant pipe is blocked.	The cooling performance is reduced; in certain cases, it may cause long-term compressor operating under overheat conditions; the lubricating effect can be affected and the compressor may be burnt if impurities were mixed with the lubricating oil.
7	Refrigerant pipe exceeds the limit.	The loss in pipe is considerable and the unit energy efficiency decreases, which are harmful for long-term running of the system.
8	Incorrect amount of refrigerant is filled.	The system cannot correctly control the flow allocation; the compressor may be operating under over-heating environment or running when the refrigerant flows back to the compressor..
9	The refrigerant pipe leaks.	Insufficient refrigerant circulating in the system decreases the cooling performance of the air conditioner. Long-term operation under such circumstance may cause an overheating compressor or even damage the compressor.
10	Water drainage from the condensate water pipe is not smooth.	Residual water in IDUs can affect the normal operation of the system. The possible water leakage can damage the IDU's decoration.
11	The ratio of slop for condensate water pipe is insufficient or the condensate water pipe is incorrectly connected.	Reverse slop or inconsistent connection of condensate water pipe can hinder the smooth drainage and cause leakage of the IDU.
12	The air channel is improperly fixed.	The air channel will deform; vibration and noise occur during unit operating.
13	The guide vane of air channel is not reasonably manufactured.	Uneven air quantity allocation reduces the overall performance of the air conditioner.

GMV5 DC INVERTER VRF UNITS SERVICE MANUAL

14	The refrigerant pipe or condensate water pipe does not meet the insulation requirement.	Water can easily condensate and drip to damage the indoor decoration, or even trigger the protection mode of system due to overheating operation.
15	The installation space for IDU is insufficient.	Since there is a lack of space for maintenance and checking, indoor decoration might need to be damaged during such operation.
16	The IDU or the location of the air outlet or return air inlet is not designed reasonably.	The air outlet or return air inlet may be short-circuited, thus affecting the air conditioning performance.
17	The ODU is improperly installed.	The ODU is difficult to be maintained; unit exhaust is not smooth, which reduces the heat exchanging performance or even prevent the system from normal operation; in addition, the cold and hot air for heat exchange and the noise may annoy people in surrounding areas.
18	Power cables are incorrectly provided.	Unit components may be damaged and potential safety hazard may occur.
19	Control communication cables are incorrectly provided or improperly connected.	The normal communication in the system fails or the control over IDUs and ODUs turn in a mess.
20	Control communication cables are not properly protected.	The communication cables are short-circuited or disconnected, and the unit cannot be started up due to communication failure.

Understand the special requirement (if any) for unit installation before implementation to ensure installation quality. Relevant installers must have corresponding engineering construction qualifications.

Special type operators involved in the engineering implementation, such as welders, electricians, and refrigeration mechanics must have relevant operating licenses and are accredited with vocational qualification certification.

## 1.3 Cooperation Between Different Professions

A quality installation of air conditioning engineering depends on careful organization and close cooperation between different professions such as architecture, structure, electric, water supply and drainage, fire-fighting, and decoration. Pipes must be laid in places away from any automatic spray head for fire-fighting, and must be reasonably arranged to ensure that the pipes fit the electric, luminaries, and decoration.

1. Requirements for cooperation with civil engineering:

- a. The riser should be installed in the air conditioning tube well, and the horizontal pipe should be placed in the ceiling, if possible.
- b. A place should be reserved for the ODU base to prevent the waterproof layer or insulating layer on the roof from being damaged in later phase of installation.
- c. At places on walls or floors where pipes need to go through, holes or casing should be preserved. If the pipe needs to go through a bearing beam, a steel casing must be prepared.

2. Requirements for cooperation with decoration engineering:

The air conditioning installation should not damage the bearing structure or the decorative style. Air conditioning pipes should be laid out along the bottom of the beam as possible. If pipes meet one another at the same elevation, process based on the following principles:

- a. Drain pipes enjoy the highest priority. Air ducts and pressure pipes should leave places for gravity pipes.
- b. Air ducts and small pipes should leave places for major pipes.

3. Requirements for cooperation with electric:

After the capacity of air conditioning unit is determined, check the following aspects with relevant electric design personnel:

- a. Whether the electrical load is designed based on the requirement of the air conditioning unit;
- b. Whether the power cable and circuit breaker meet the unit requirement and abide by relevant national safety regulations;
- c. Whether the regional power supply quality (including voltage fluctuation and interference noise) meet the international requirement.

Any nonconformity must be resolved through coordination.

# GMV5 DC INVERTER VRF UNITS SERVICE MANUAL

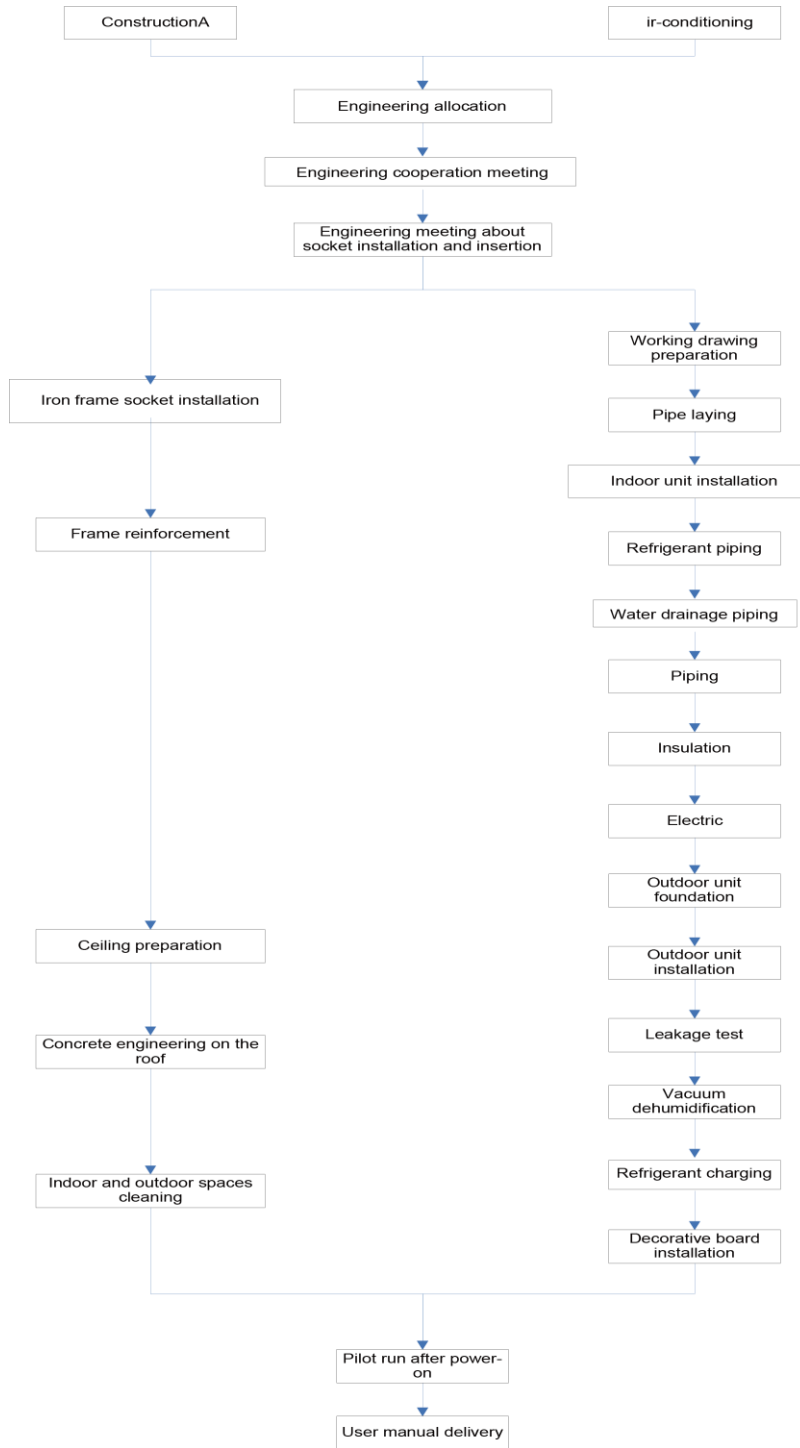

## 1.4 Onsite Review of Design Drawing

Installation personnel must carefully read and understand the design scheme and drawings provided by engineering designers, and prepare detailed and feasible construction organization design after reviewing the onsite status.

The following aspects of working drawing must be reviewed:

1. The loads of indoor and ODUs must match. The gross rated capacity of the IDU should be set to a value that is 50% to 135% of the rated capacity of the ODU. In actual conditions, if the capacity of concurrently operating IDUs exceeds 100% of the rated capacity of the ODU, the air conditioning system fails to meet the requirement. Note: Configuration in excess of the capacity of the IDUs can affect the comfort for users. The more the excess is, the lower the adjustment capacity of an air conditioning unit will be. When the capacity exceeds 135% of the configured value, the system reliability can be affected. Therefore, relevant regulations on capacity limit must be strictly followed.
2. The difference of level between an ODU and an IDU, and that between IDUs must be set within the designed range.
3. Pipe bend for trapped oil is required for air pipe riser in the unit to ensure normal circulation in the unit lubricating system.
4. The pipe diameter and manifold type in the cooling system must meet relevant technical specifications.
5. The drainage method of unit condensate water must be reasonable; the pipeline slope must follow the design requirement of unit.
6. The air duct direction and air flow are reasonably organized.
7. The configuration specifications, type, and control method of power cables should meet the design requirement of unit.
8. The arrangement, total length, and control method of control line should meet the design requirement of unit.

Note: Engineering construction personnel must strictly abide by the design drawings. If any design cannot be implemented during construction and needs to be modified, contact the designer first for approval and prepare a written document, that is, the design modification record.



# 1.5 Construction Organization Process

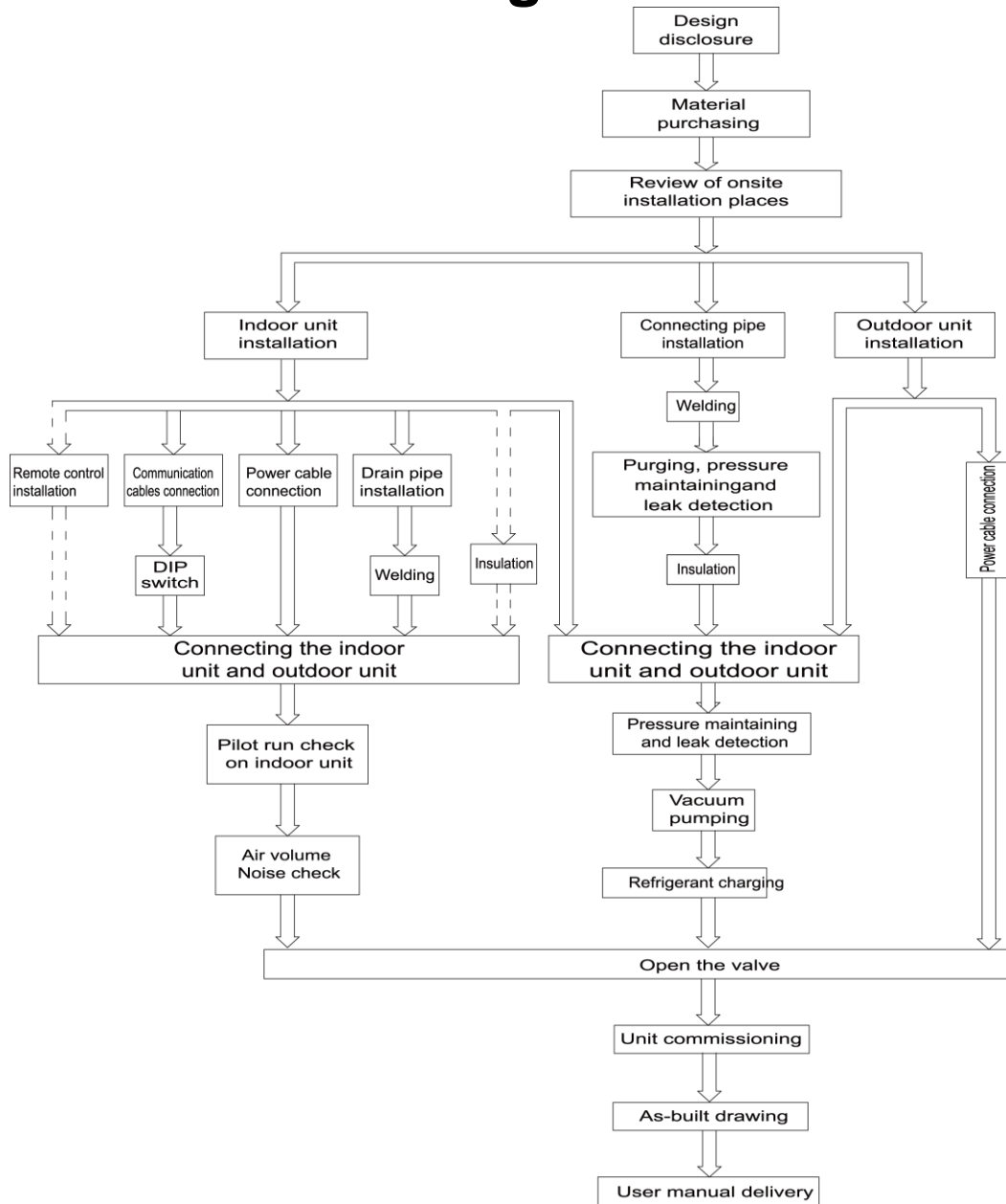

## **2 Material Selection**

### **2.1 Requirement for Selecting Construction Materials**

The materials, equipment and instruments used during air conditioning engineering construction must have certifications and test reports.

Products with fireproof requirements must be provided with fireproof inspection certificates and must meet national and relevant compulsory standards.

If environmentally-friendly materials are to be used as required by customers, all such materials must meet national environmental protection requirement and be provided with relevant certificates.

## 2.2 Requirement for Selecting Major Materials

### 2.2.1 Copper pipe

- Material requirement: Dephosphorization drawing copper pipe for air conditioners
- Appearance requirement: The inner and outer surface of pipe should be smooth without pinhole, crack, peeling, blister, inclusion, copper powder, carbon deposition, rust, dirt or severe oxide film, and without obvious scratch, pit, spot and other defects.
- Test report: Certifications and quality test reports must be provided.
- The tensile strength must be at least 240 kgf/mm<sup>2</sup>.
- Specifications requirement

R410A Refrigerant System		
OD (mm)	Wall Thickness (mm)	Model
Φ6.35	≥0.8	0
Φ9.52	≥0.8	0
Φ12.7	≥0.8	0
Φ15.9	≥1.0	0
Φ19.05	≥1.0	0
Φ22.2	≥1.2	1/2H
Φ25.4	≥1.2	1/2H
Φ28.6	≥1.2	1/2H
Φ31.8	≥1.3	1/2H
Φ34.9	≥1.3	1/2H
Φ38.1	≥1.5	1/2H
Φ41.3	≥1.5	1/2H
Φ44.5	≥1.5	1/2H
Φ51.4	≥1.5	1/2H
Φ54.1	≥1.5	1/2H

- After the inner part of the copper pipe is cleaned and dried, the inlet and outlet must be sealed tightly by using pipe caps, plugs or adhesive tapes.

### 2.2.2 Condensate water pipe

- Pipes that can be used for air conditioner drainage include: water supplying UPVC pipe, PP-R pipe, PP-C pipe, and HDG steel pipe.
- All relevant certificates and quality test reports are provided.
- Requirements for specifications and wall thickness  
Water supplying UPVC pipe: Φ32mm×2mm, Φ40mm×2mm, Φ50mm×2.5mm;  
HDG steel pipe: Φ25mm×3.25mm, Φ32mm×3.25mm, Φ40mm×3.5mm, Φ50mm×3.5mm.

### 2.2.3 Insulation material

- Rubber foam insulation material;
- Flame retardancy level: B1 or higher;
- Refractoriness: at least 120℃;
- The insulation thickness of condensate water pipe: at least 10 mm;
- When the diameter of copper pipe is equal to or greater than Φ15.9 mm, the thickness of insulation material should be at least 20 mm; when the diameter of copper pipe is less than 15.9 mm, the thickness of insulation material should be at least 15 mm.

### 2.2.4 Communication cable and control cable

Note: For air conditioning units installed in places with strong electromagnetic interference, shielded wire must be used as the communication cables of the IDU and wired controller, and shielded twisted pairs must be used as the communication cables between IDUs and between the IDU and ODU.

Communication cable selection for outdoor and IDUs

Material Type	Total Length L(m) of Communication Cable between IDU Unit and IDU (ODU ) Unit	Wire size (mm <sup>2</sup> )	Material Standard	Remarks
Light/Ordinary polyvinyl chloride sheathed cord. (60227 IEC 52 /60227 IEC 53)	L≤1000	≥2×0.75	IEC 60227-5:2007	1. If the wire diameter is enlarged to 2 × 1 mm <sup>2</sup> , the total communication length can reach 1500m. 2. The cord shall be Circular cord (the cores shall be twisted together). 3. If unit is installed in places with intense magnetic field or strong interference, it is necessary to use shielded wire.

Communication cable selection for IDU and wired controller

Material type	Total length of communication line between IDU unit and wired controller L (m)	Wire size (mm <sup>2</sup> )	Material standard	Remarks
Light/Ordinary polyvinyl chloride sheathed cord. (60227 IEC 52 /60227 IEC 53)	L≤250	2×0.75~2×1.25	IEC 60227-5:2007	1. Total length of communication line can't exceed 250m. 2. The cord shall be Circular cord (the cores shall be twisted together). 3. If unit is installed in places with intense magnetic field or strong interference, it is necessary to use shielded wire.

**2.2.5 Power cable**

Only copper conductors can be used as power cables. The copper conductors must meet relevant national standard and satisfy the carrying capacity of unit.

## 3 Installation Space Requirement

### 3.1 Place Selection for Installing ODU

The widely-used VRF units are applicable for various scenarios. In residential areas, especially in rooms where elderly and infants live, a higher refrigerating performance and noise control is required. Therefore, the ODU with excellent capacity and low noise is preferred; in addition, ODU should be installed in outdoor spaces instead of in bedrooms, studies or meeting rooms. In commercial areas, ODU should be installed far away from offices.

### 3.2 ODU Dimensions and Installation Hole Size

Outline and Physical Dimension of GMV-224WM/B-X and GMV-280WM/B-X unit.

unit:mm

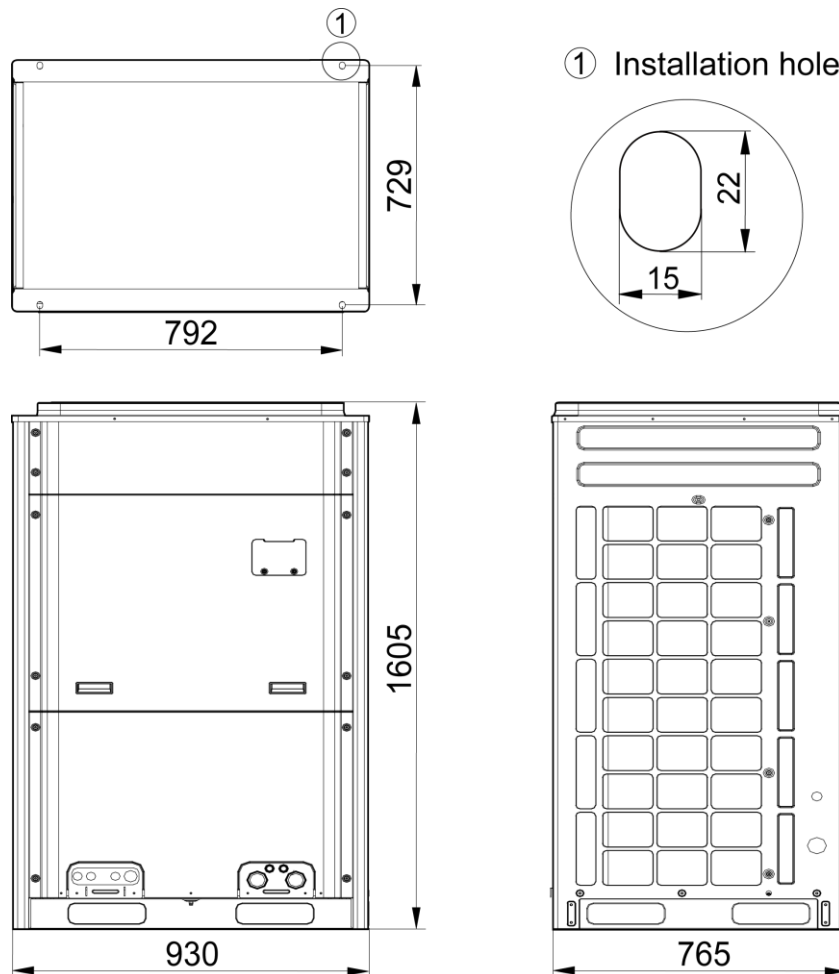

Outline and Physical Dimension of GMV-335WM/B-X、GMV-400WM/B-X and GMV-450WM/B-X unit.

unit:mm

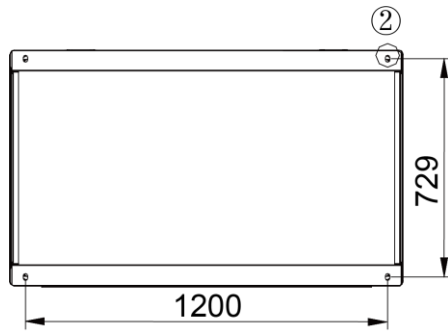

② Installation hole

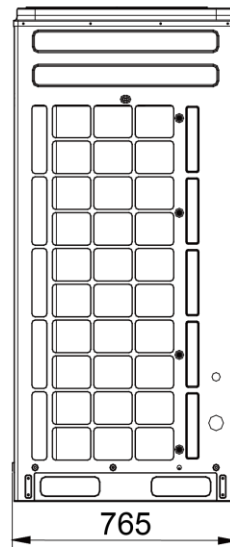
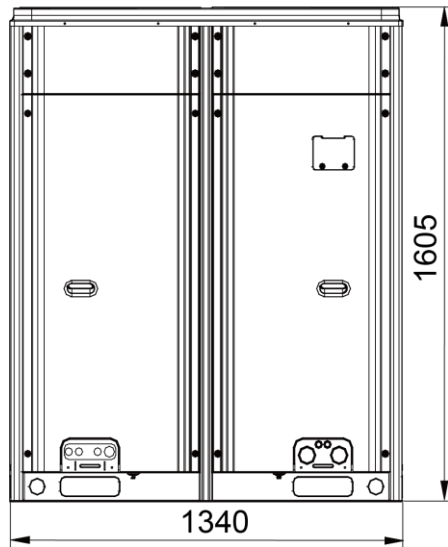
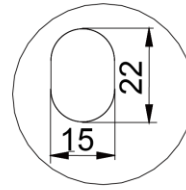

Outline and Physical Dimension of GMV-504WM/B-X, GMV-560WM/B-X and GMV-615WM/B-X unit.

unit:mm

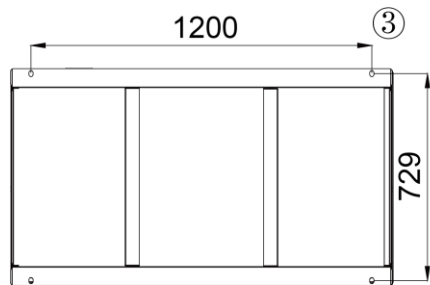

③ Installation hole

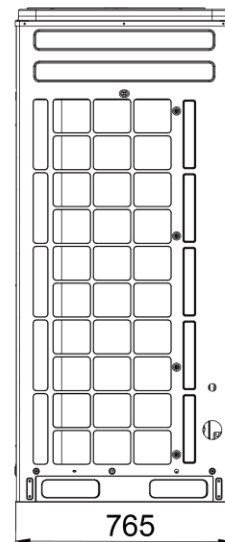
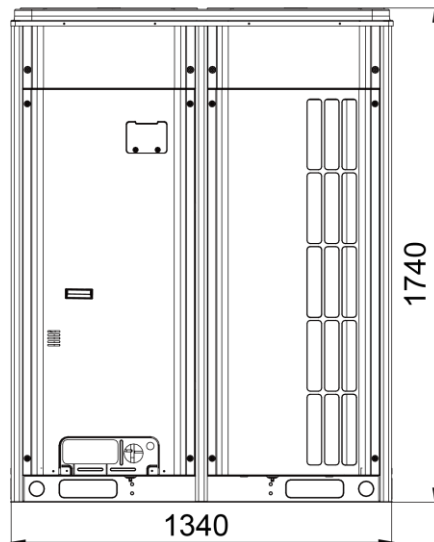
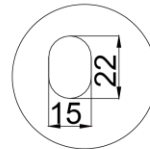

# 3.3 Installation Space Requirement for ODU

3.3.1 If all sides of the ODU (including the top) are surrounded by walls, process according to the following requirements for installation space:

Installation space requirement for single-module unit

unit:mm

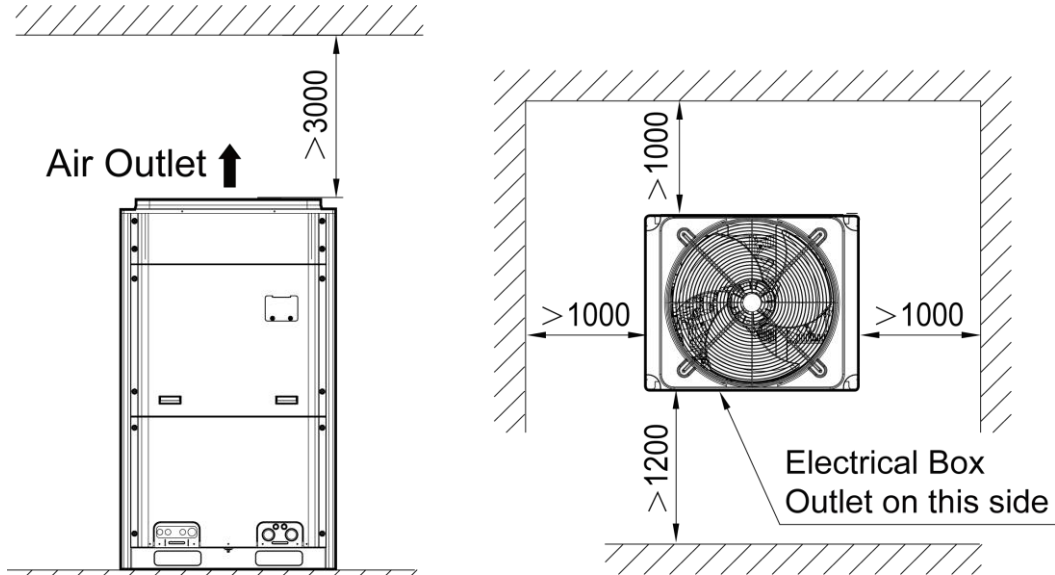

Installation space requirement for dual-module unit

unit:mm

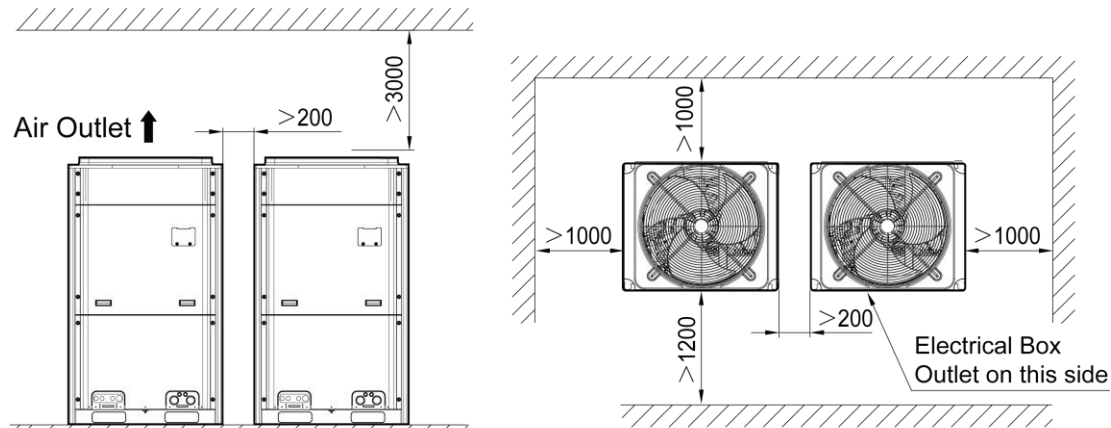

Installation space requirements for triple-module unit

unit:mm

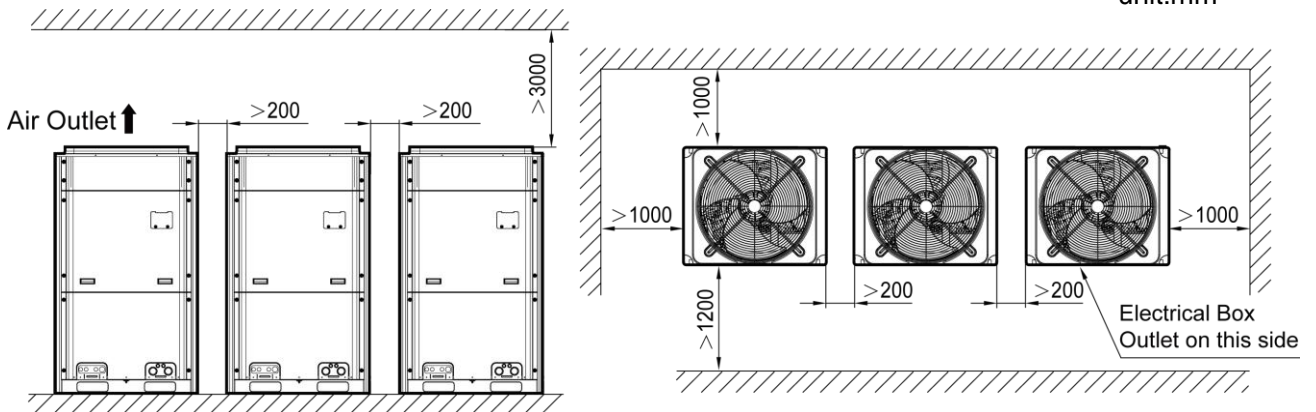

Installation space requirement for quad-module unit

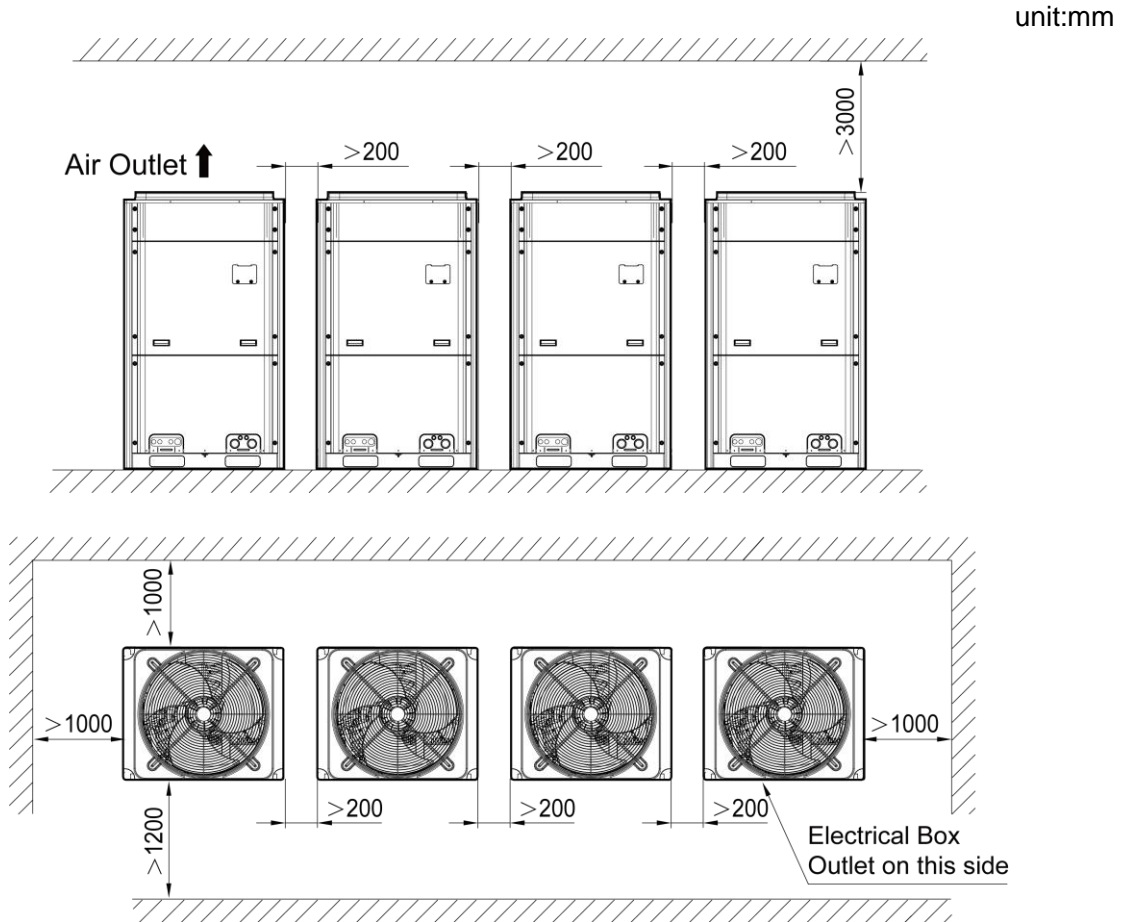

3.3.2 In principle, if a crown wall (obstacles for keeping out the wind) exists over the machine, a distance of at least 3000 mm should be left between the top of the machine and the crown wall. If the front, rear, left and right sides of the machine are open spaces, the distance between the top of the machine and the crown wall should be at least 1500 mm, as shown in Fig. (a). If the requirement for the minimum 1500 mm cannot be met, or the spaces around the machine are not open, an air return pipe needs to be connected to maintain smooth ventilation, as shown in Fig. (b).

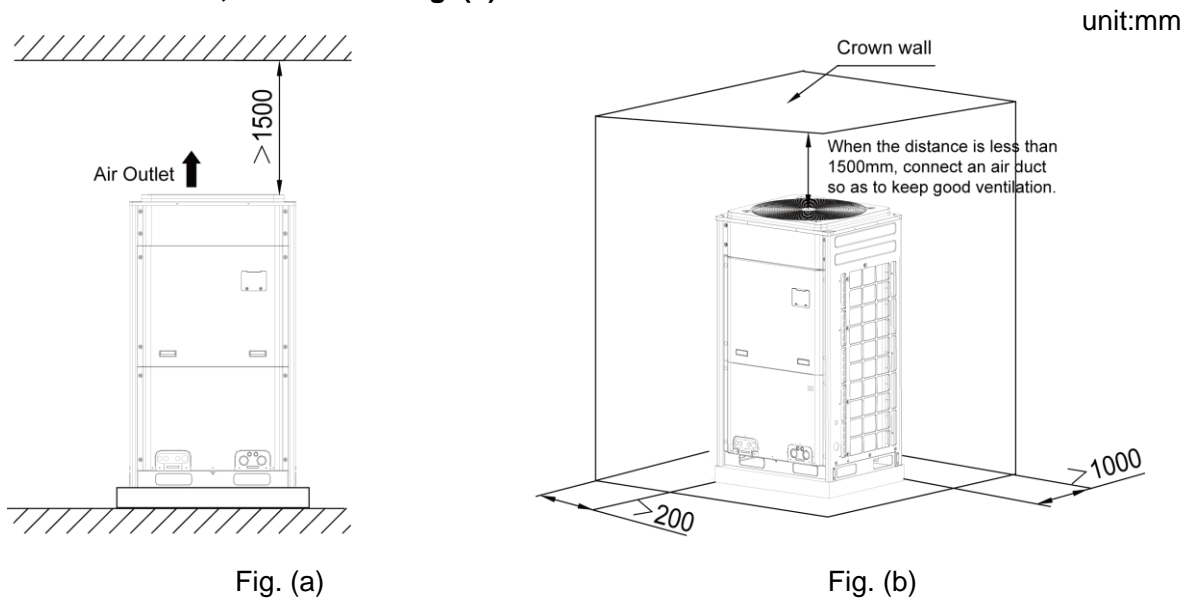

Fig. (a)

Fig. (b)

Installation space requirement for multiple ODUs

To ensure smooth ventilation, the top of the unit must be open spaces without obstacles.

If there is an open space at the front side and left side (or right side) of the outdoor unit, the



units should be installed towards the same direction or reverse direction.

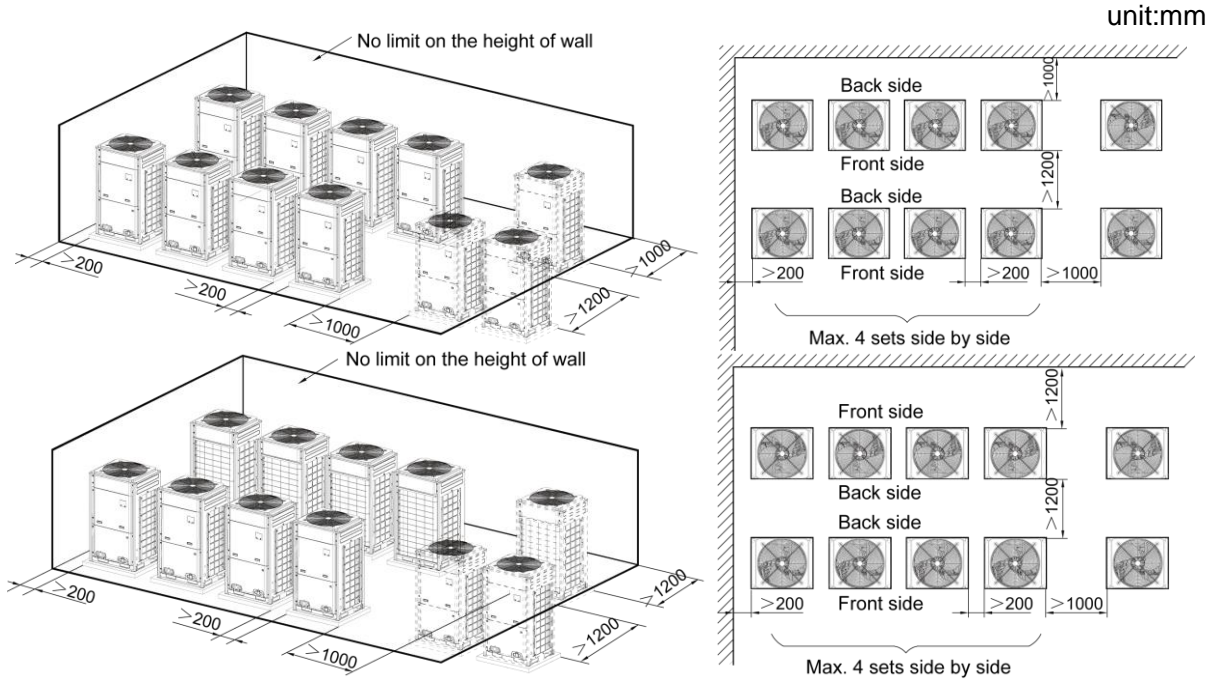

**3.3.3 Monsoons must be considered during ODU installation.**

Anti-monsoon installation requirements for unit not connecting exhaust duct:

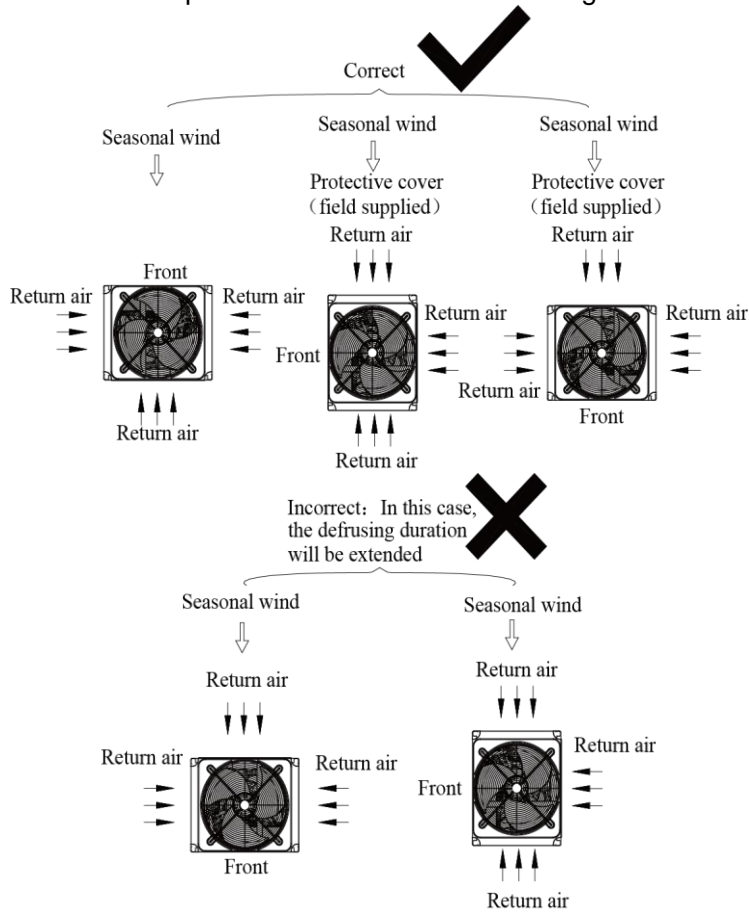

Anti-monsoon installation requirements for unit connecting exhaust duct:

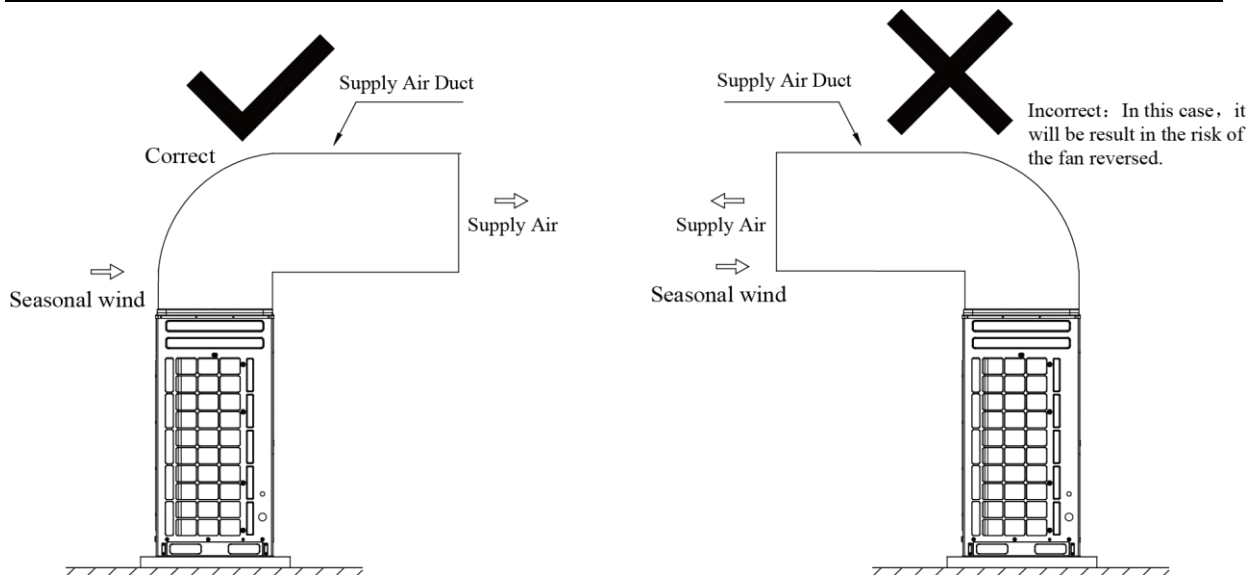

**3.3.4 Snow must be considered during ODU installation.**

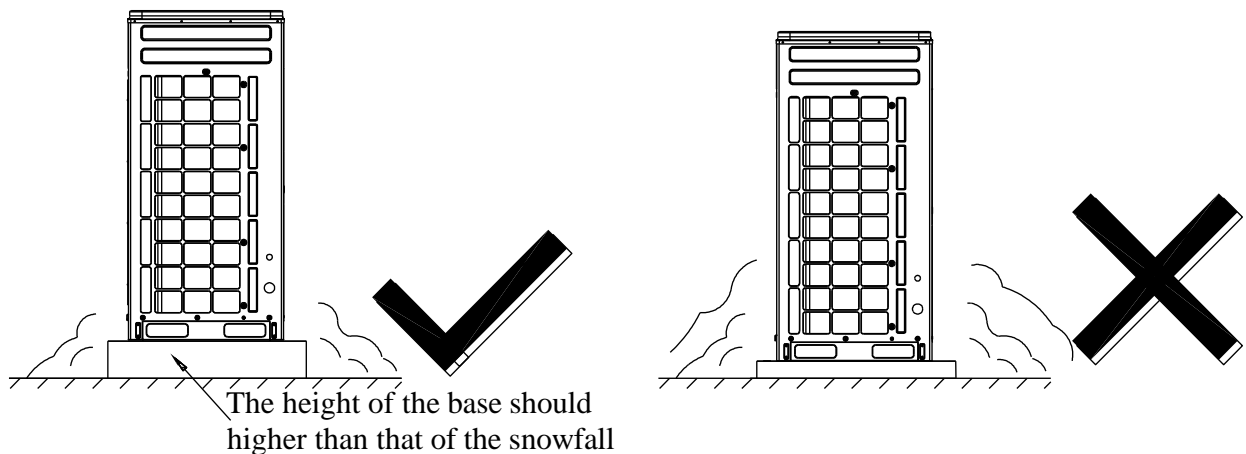

**3.3.5 During the installation of the ODU, induced and exhaust pipes must be connected. In addition, the aperture opening rate of shutters must be at least 80%, and the angle between the shutters and the horizontal plane should be less than 20°. Requirements for installing exhaust air duct are as follows:**

- i. Basic requirement for connecting an ODU to static pressure ventilating duct
 

When an ODU needs to be connected to the static pressure ventilating duct, the ventilating duct must be reasonably designed. The pressure loss caused by the ventilating duct must be calculated. In addition, a proper type of ventilating duct is necessary. To connect the static pressure ventilating duct to the ODU, three basic parts are required: (1) ODU; (2) canvas; and (3) steel-plate ventilating duct. The ODU must be interconnected with the ventilating duct through canvas to prevent abnormal vibration and noise generated by the steel-plate ventilating duct. The joint part must be tightly sealed with tin foil to avoid air leakage.
- ii. Preparations for connecting an ODU to static pressure ventilating duct
  - (1) The ODU is installed properly based on the unit installation requirement.
  - (2) The steel-plate ventilating duct is designed based on the unit and engineering requirement, and is installed properly according to the engineering standards.
  - (3) Based on the unit dimensions and the size of steel-plate ventilating duct, prepare materials such as canvas casing, tin foil, steel bar and tapping screw, as well as tools such as hand-operated electric drill, air screw driver and screwdriver.
- iii. Basic operation of connecting an ODU to static pressure ventilating duct
 

Two methods are available to connect an ODU to static pressure ventilating duct.

Method 1: Reserve the unit top case. Detailed operations are as follows:

  - a) Install the ODU (2) and steel-plate ventilating duct (1). Use an air screw driver or

screwdriver to unfasten the tapping screws that fixing the top case component (3), and then remove the top case component. Take out the grille from the top of the top case component and leave the top case.

- b) Put the canvas casing inside out (4). Cover one end of the canvas casing over the unit downward until the canvas end face is aligned with the unit or a bit higher than the top of the unit. Then, put the top case back (3) and tightly press the canvas casing (4). Use tapping screws to fix the top case onto the unit (3).
- c) Pull up the canvas casing reversely (4) and use the steel bar (5) to press the canvas casing tightly onto the counter flange of the steel-plate ventilating duct (1). Use a hand-operated electric drill to drill holes and fasten the parts by using tapping screws.
- d) Use the tin foil to seal the joints and check the joints' reliability.

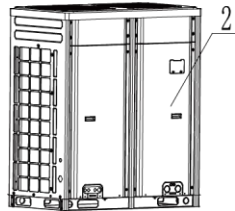
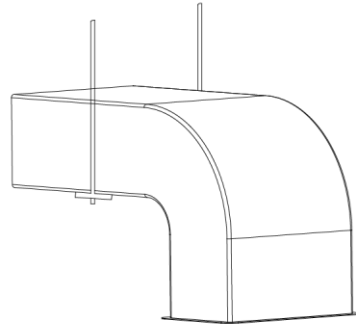
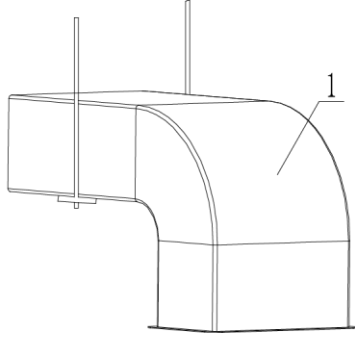

Step 1

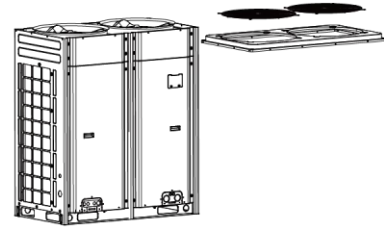

Step 2

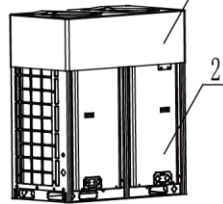
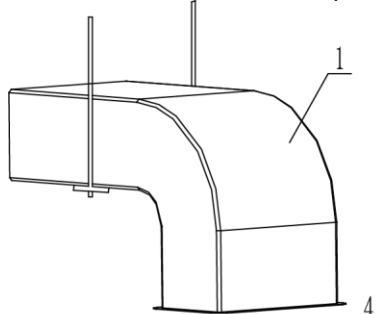

Step 3

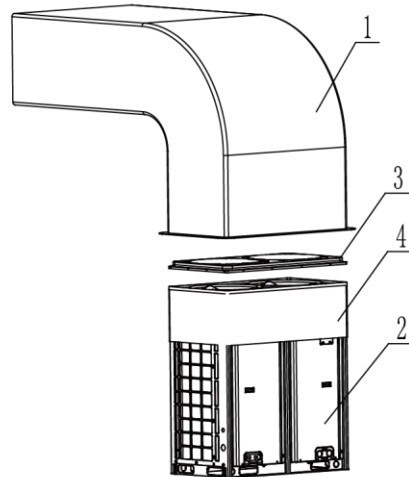

Step 4

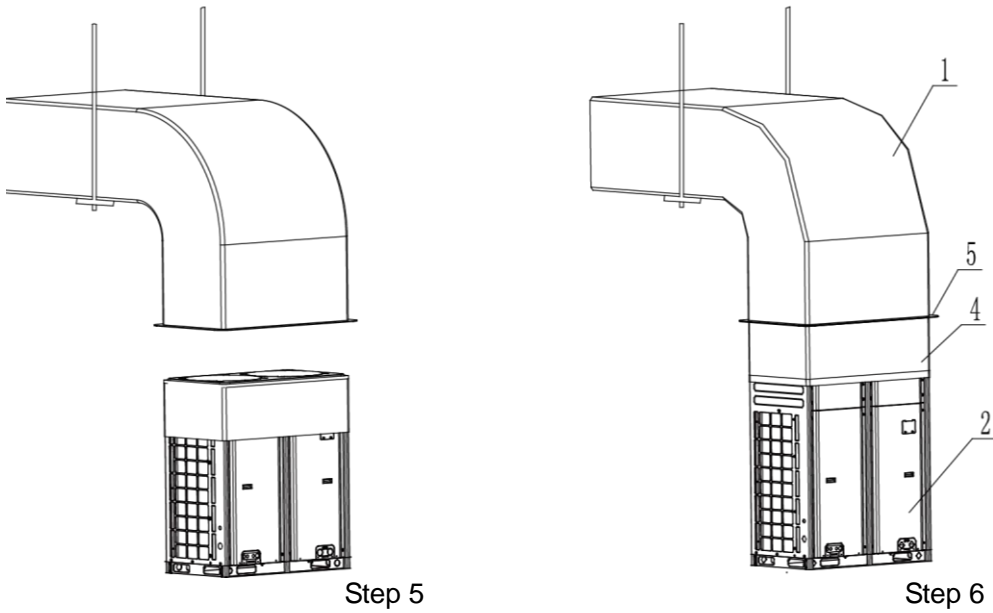

Method 2: Remove the unit top case. Detailed operations are as follows:

- (1) Install the ODU (2) and steel-plate ventilating duct (1). Take out the grille from the top of the top case component. Use the prepared canvas casing inside out (4) to cover the surroundings over the top of the unit. Keep the top of canvas casing (4) 30 to 50 mm higher over the top of the unit.
- (2) Use a steel bar to press tightly the canvas casing (4) around the top case of the unit. Use a hand-operated electric drill to drill holes and fasten the canvas casing onto the unit through steel bar by using tapping screws.
- (3) Pull up the canvas casing reversely and use the steel bar to press the canvas casing tightly onto the counter flange of the steel-plate ventilating duct. Use a hand-operated electric drill to drill holes and fasten the parts by using tapping screws.
- (4) Use the tin foil to seal the joints and check the joints' reliability.

Note: Remove the grille on the top case when connecting an ODU to static pressure ventilating duct; otherwise, the air volume, especially the unit operating performance will be affected. For method 2, since drills are required on the top case, the powder coated protective layer on the top case will be damaged. As a result, the anti-corrosion performance of the unit top case will be reduced.

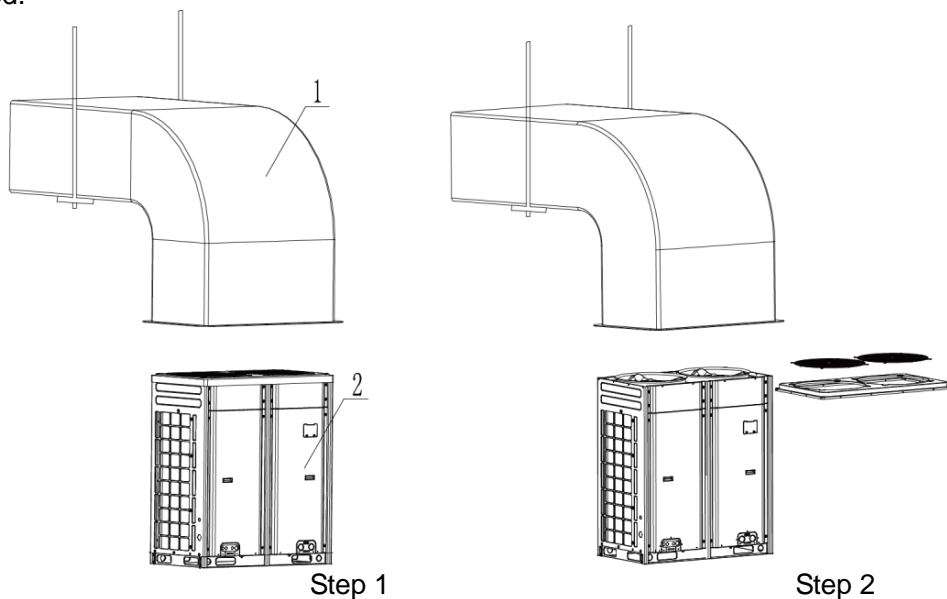

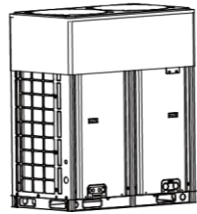
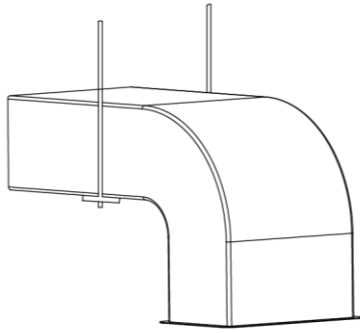

Step 3

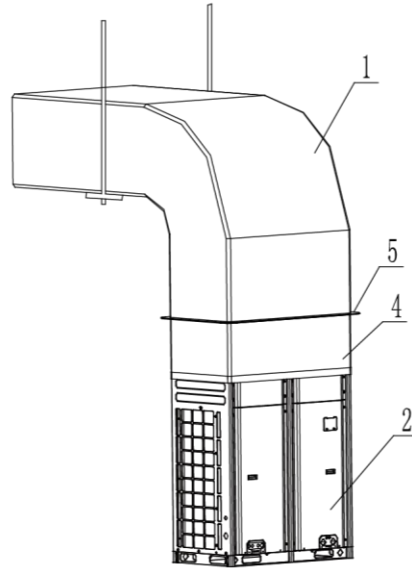

Step 4

**3.3.6 When the effective area of air intake is less than 70% of the total air intake area of all ODUs, an induced draft fan is also required. The total air input of induced draft fan should be no less than 80% of the total supply air rate.**

## 4 Requirements on Foundation Installation

### 4.1 ODU Foundation

The concrete foundation of the ODU must be strong enough. Ensure that the drainage is smooth and that the ground drainage or floor drainage is not affected.

Requirements on the concrete foundation are as follows:

- A. The concrete foundation must be flat and have enough rigidity and strength to undertake the unit's weight during running. The height of the foundation is 200 mm to 300 mm, which is determined based on the size of the unit.
- B. The proportion of the cement, sand, and stone for the concrete is 1:2:4. Place 10 reinforced steel bars ( $\phi 10$  mm) with a space between of 30 mm.
- C. Use the mortar to flatten the surface of the foundation. Sharp edges must be chamfered.
- D. When the foundation is built on a concrete floor, crushed stones are not required. But the foundation surface must be roughened.
- E. Clear the oil stains, crushed stones, dirt, and water in the reserved bolt hole of the foundation and install a temporary cover before installing bolts.
- F. Build a drainage ditch around the foundation to discharge the condensate water.
- G. If the air conditioner is installed on the roof, check the intensity of the building and take waterproof measures.
- H. If a u-steel foundation is adopted, the structure must be designed with sufficient rigidity and strength.

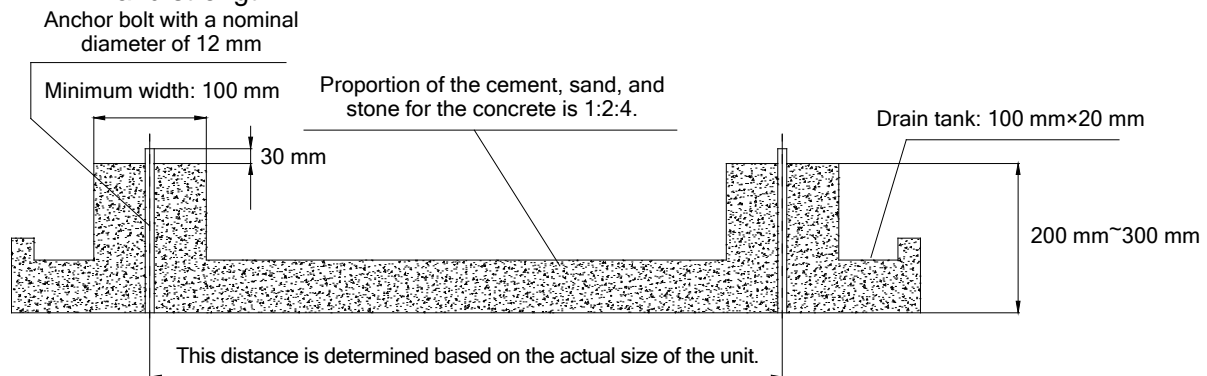

Cement foundation diagram

### 4.2 ODU Fixing

Fix the ODU to the foundation with four M12 bolts securely to reduce vibration and noise.

### 4.3 Vibration Reduction for ODU

The ODU must be fixed securely. Apply a thick rubber sheet or corrugated damping rubber pad with thickness of 20 mm or more and width of 100 mm or more between the ODU and the foundation, as shown in the following figures.

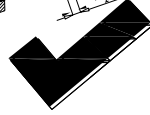
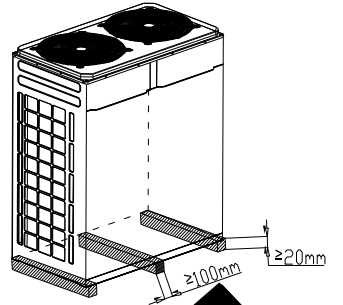
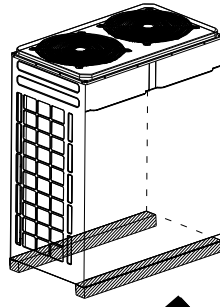
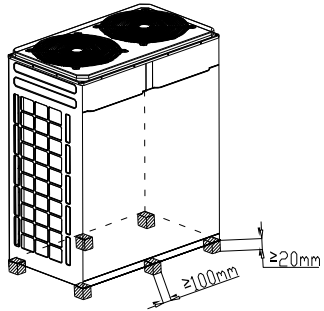
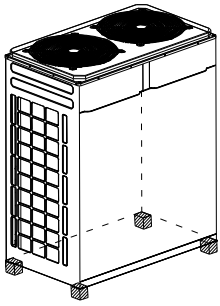

# 5 Piping Connection

## 5.1 Schematic Diagram of Piping Connection

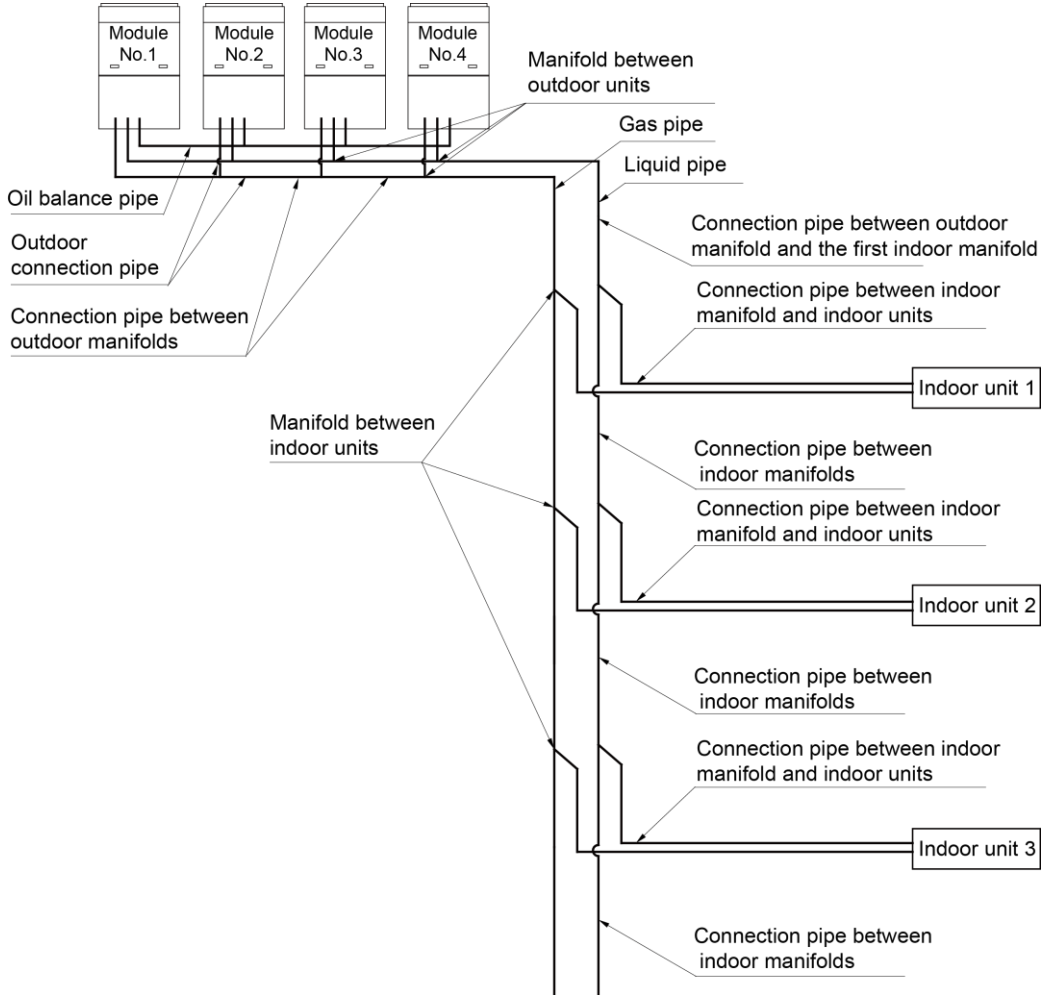



# 5.2 Schematic Diagram of Piping Sequence

GMV-224WM/B-X and GMV-280WM/B-X

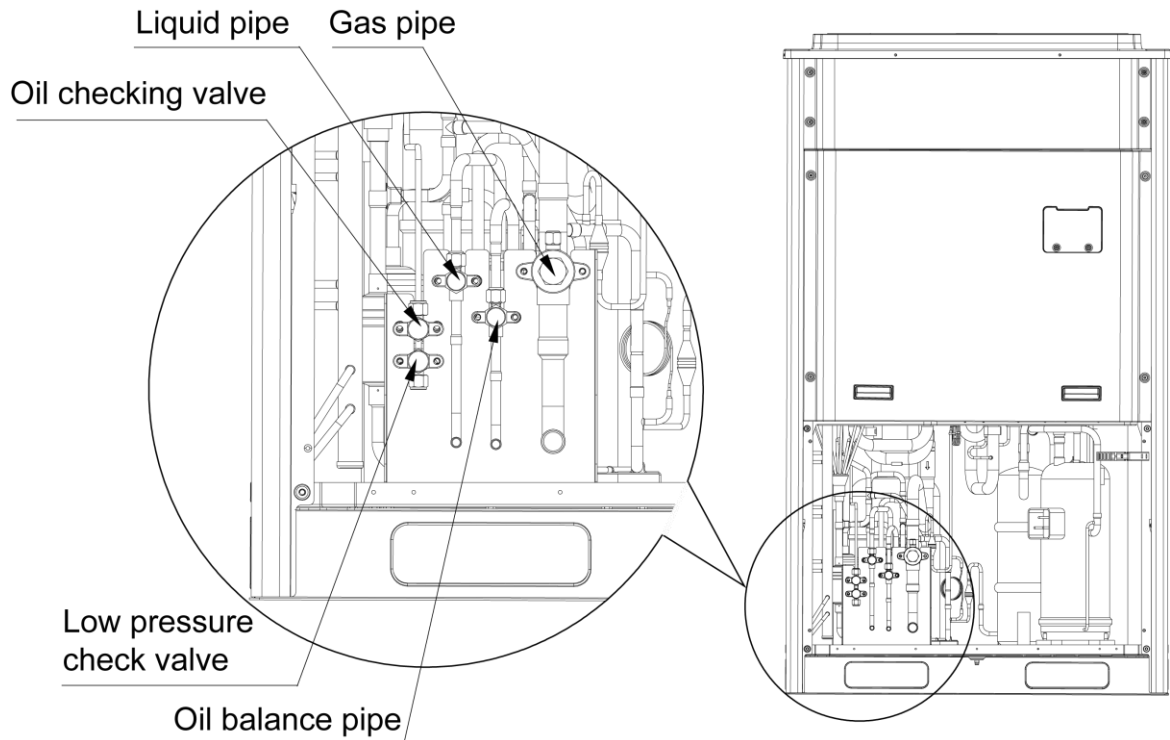

GMV-335WM/B-X , GMV-400WM/B-X and GMV-450WM/B-X

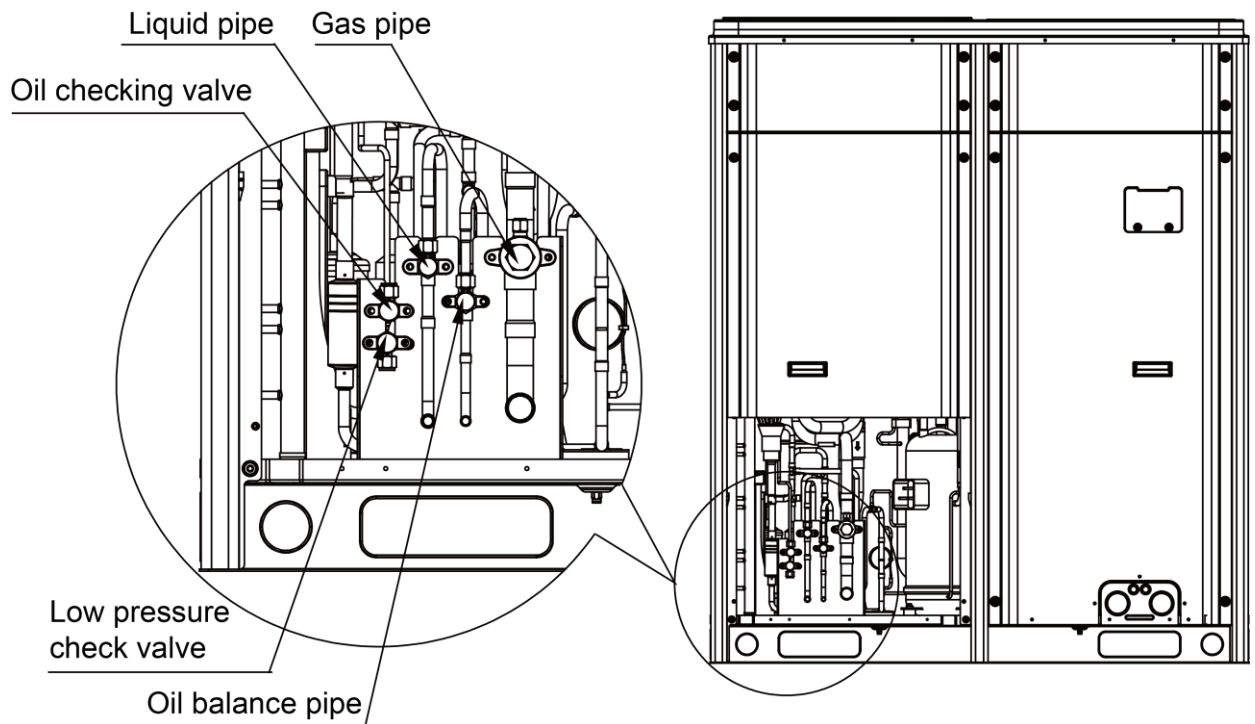

GMV-504WM/B-X, GMV-560WM/B-X and GMV-615WM/B-X

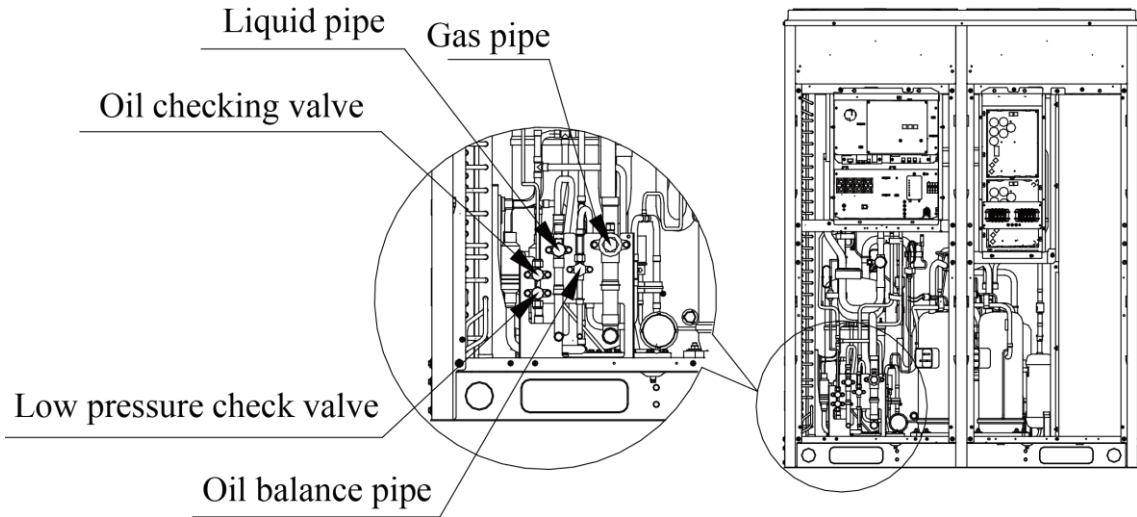

# 5.3 Allowable pipe length and drop height among indoor and outdoor units

Y type branch joint is adopted to connected indoor and outdoor units. Connecting method is shown in the figure below

Remark Equivalent length of one Y-type manifold is about 0.5m.

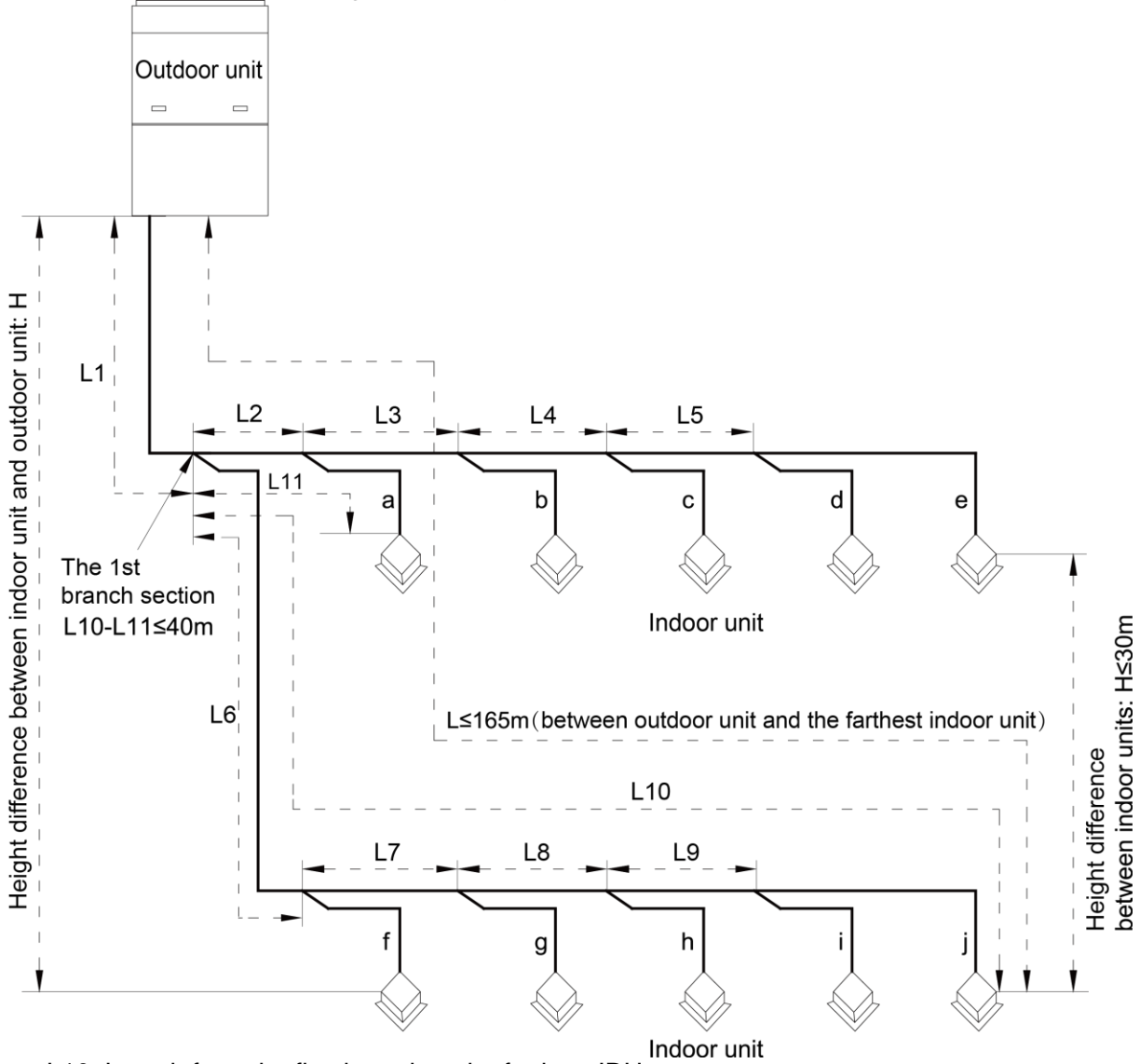

L10: Length from the first branch to the farthest IDU;  
 L11: Length from the first branch to the nearest IDU;  
 Equivalent length of branch of IDU is 0.5m.

R410A Refrigerant System		Allowable Value	Fitting Pipe
Total length (actual length) of fitting pipe		≤1000	$L1+L2+L3+L4+...+L9+a+b+...+i+j$
Length of farthest fitting pipe(m)	Actual length	≤165	$L1+L6+L7+L8+L9+j$
	Equivalent length	≤190	
Difference between the pipe length from the first branch of IDU to the farthest IDU and the pipe length from the first branch of IDU to the nearest IDU		≤40	L10-L11
Equivalent length from the first branch to the furthest piping (1)		≤40	$L6+L7+L8+L9+j$

GMV5 DC INVERTER VRF UNITS SERVICE MANUAL

Height difference between outdoor unit and indoor unit	Outdoor unit at upper(4)	≤90	—
	Outdoor unit at lower(4)	≤90	—
Height difference between indoor units (m)		≤30	—
Maximum length of Main pipe(2)		<90	L1
From IDU to its nearest branch (3)		≤40	a,b,c,d,e,f,g,h,i,j

**Note:**

(1) Normally, the pipe length from the first branch of IDU to the farthest IDU is 40m. When those three conditions as below are satisfied, the length can reached 90m.

- ① Actual length of pipe in total:  $L1+L2x2+L3x2+L4x2+...+L9x2+a+b+...+i+j \leq 1000m$ ;
- ② Length between each IDU and its nearest branch a, b, c, d, e, f, g, h, i, j ≤40m;
- ③ Difference between the pipe length from the first branch of IDU to the farthest IDU and the pipe length from the first branch of IDU to the nearest IDU:  $L10-L11 \leq 40m$ .

(2) When the maximum length of the main pipe from ODU to the first branch of IDU is ≥90m, then adjust the pipe size of the gas pipe and liquid pipe of main pipe according to the following table.

Outdoor Model	Gas pipe size(mm)	Liquid pipe size(mm)
GMV-224WM/B-X	No need to enlarge pipe size	No need to enlarge pipe size
GMV-280WM/B-X	No need to enlarge pipe size	Φ12.7
GMV-335WM/B-X	Φ28.6	Φ15.9
GMV-400WM/B-X	Φ28.6	Φ15.9
GMV-450WM/B-X	Φ31.8	Φ15.9
GMV-504WM/B-X	Φ31.8	Φ19.05
GMV-560WM/B-X	Φ31.8	Φ19.05
GMV-615WM/B-X	Φ31.8	Φ19.05
GMV-680WM/B-X	Φ31.8	Φ19.05
GMV-730WM/B-X	Φ38.1	Φ22.2
GMV-785WM/B-X	Φ38.1	Φ22.2
GMV-850WM/B-X	Φ38.1	Φ22.2
GMV-900WM/B-X	Φ38.1	Φ22.2
GMV-960WM/B-X	Φ38.1	Φ22.2
GMV-1010WM/B-X	Φ41.3	Φ22.2
GMV-1065WM/B-X	Φ41.3	Φ22.2
GMV-1130WM/B-X	Φ41.3	Φ22.2
GMV-1180WM/B-X	Φ41.3	Φ22.2
GMV-1235WM/B-X	Φ41.3	Φ22.2
GMV-1300WM/B-X	Φ41.3	Φ22.2
GMV-1350WM/B-X	Φ41.3	Φ22.2
GMV-1410WM/B-X	Φ44.5	Φ22.2

GMV5 DC INVERTER VRF UNITS SERVICE MANUAL

GMV-1460WM/B-X	Φ44.5	Φ22.2
GMV-1515WM/B-X	Φ44.5	Φ22.2
GMV-1580WM/B-X	Φ44.5	Φ22.2
GMV-1630WM/B-X	Φ44.5	Φ22.2
GMV-1685WM/B-X	Φ44.5	Φ22.2
GMV-1750WM/B-X	Φ44.5	Φ22.2
GMV-1800WM/B-X	Φ44.5	Φ22.2
GMV-1854WM/B-X	Φ44.5	Φ22.2
GMV-1908WM/B-X	Φ51.4	Φ25.4
GMV-1962WM/B-X	Φ51.4	Φ25.4
GMV-2016WM/B-X	Φ51.4	Φ25.4
GMV-2072WM/B-X	Φ51.4	Φ25.4
GMV-2128WM/B-X	Φ51.4	Φ25.4
GMV-2184WM/B-X	Φ51.4	Φ25.4
GMV-2240WM/B-X	Φ51.4	Φ25.4
GMV-2295WM/B-X	Φ51.4	Φ25.4
GMV-2350WM/B-X	Φ51.4	Φ25.4
GMV-2405WM/B-X	Φ51.4	Φ25.4
GMV-2460WM/B-X	Φ51.4	Φ25.4

(3) If the length between an IDU and its nearest branch is above 10m, then increase the size of the liquid pipe of IDU (only for the pipe size that is ≤6.35mm).

(4) If the height difference between indoor and outdoor units exceeds 90m, please consult the manufacturer for specific technical requirements.

# 5.4 Connection Pipe among Outdoor Modules

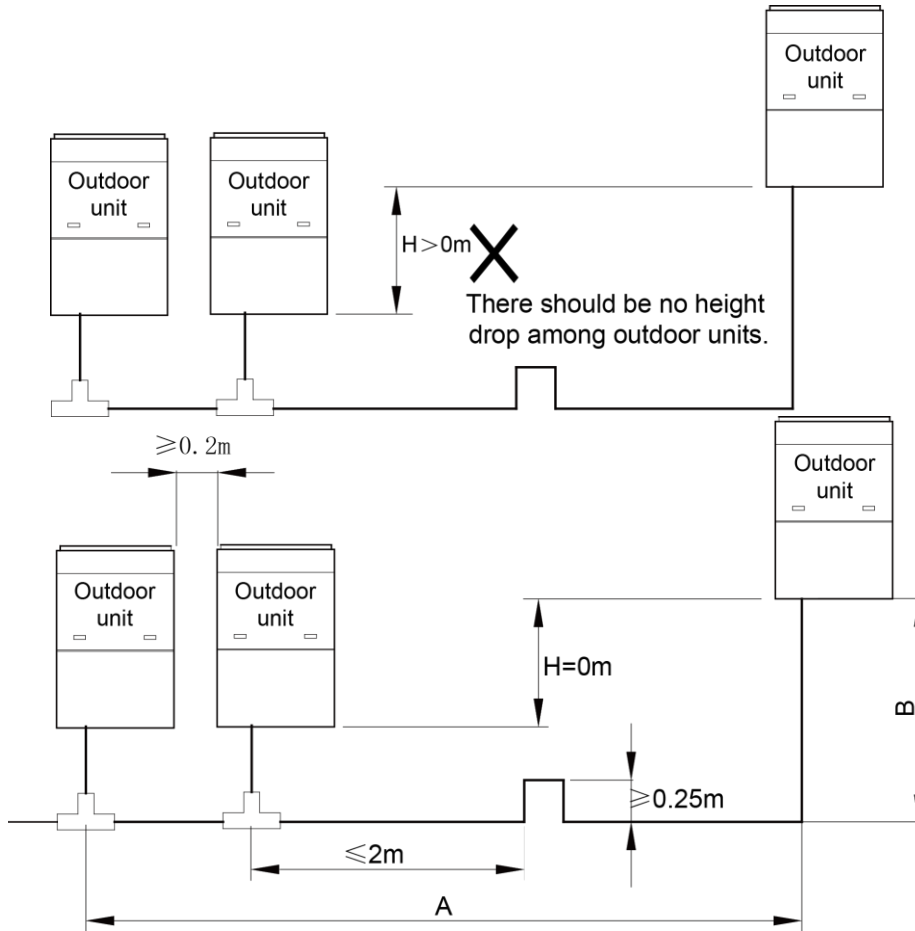

Note: When the distance between outdoor units exceeds 2m, U-type oil trap should be added at low-pressure gas pipe.  $A+B \leq 10m$ .

Pipe connection among ODUs must meet the following requirements:

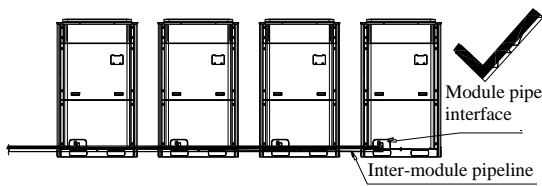

Piping between modules is at the same level with the module pipe connector.

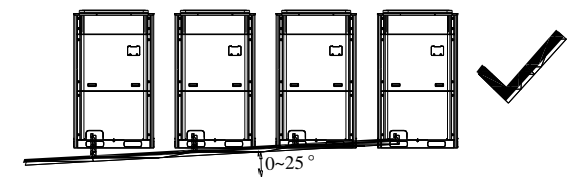

Piping between modules is under the module pipe connector and increases upwards with an angle of  $0^\circ$  to  $25^\circ$ .

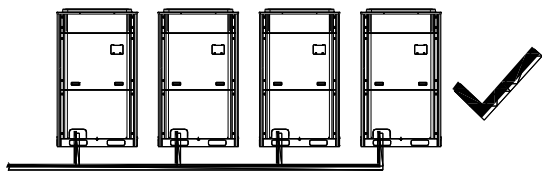

Piping between modules is under the module pipe connector and does not incline.

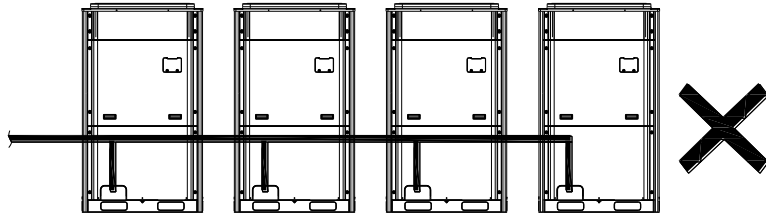

Pipeing between modules is above the module pipe connector

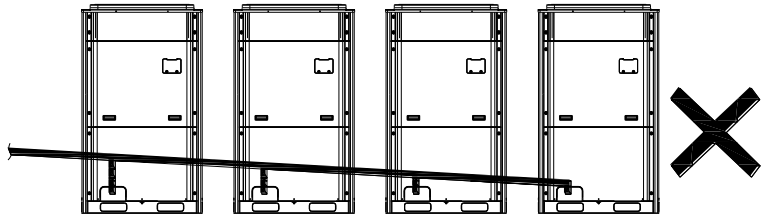

Pipeing between modules is above the module pipe connector

# 5.5 Fitting pipe between Outdoor Unit and the First Manifold

5.5.1 For single module system, pipe size (between outdoor unit and the first manifold) is determined by that of outdoor unit.

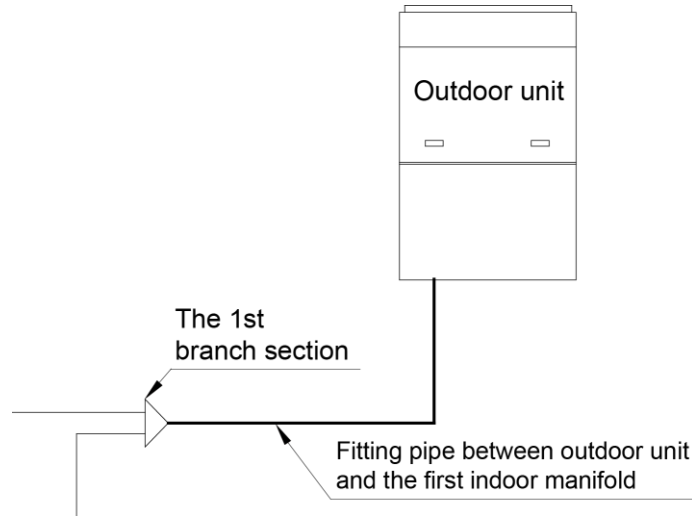

Pipe size of basic outdoor module is shown as follows:

Basic Module	Pipe between ODU and the first branch of IDU	
	Gas Pipe(mm)	Liquid Pipe(mm)
GMV-224WM/B-X	Φ19.05	Φ9.52
GMV-280WM/B-X	Φ22.2	Φ9.52
GMV-335WM/B-X	Φ25.4	Φ12.7
GMV-400WM/B-X	Φ25.4	Φ12.7
GMV-450WM/B-X	Φ28.6	Φ12.7
GMV-504WM/B-X	Φ28.6	Φ15.9
GMV-560WM/B-X	Φ28.6	Φ15.9
GMV-615WM/B-X	Φ28.6	Φ15.9

5.5.2 For multi-module unit, select appropriate manifold connected to outdoor module as per the pipe size of basic module. Pipe size of basic outdoor module is shown as follows:

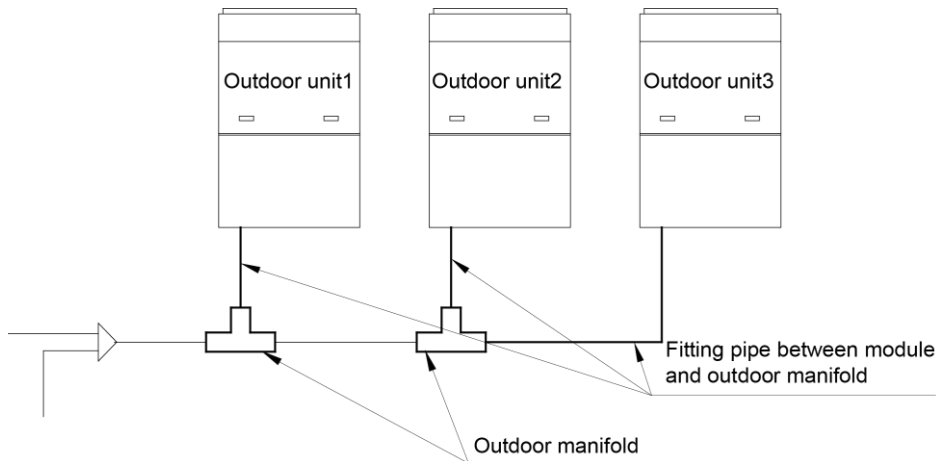



**GMV5 DC INVERTER VRF UNITS SERVICE MANUAL**

Basic Module	Pipe between module and branch of ODU	
	Gas Pipe(mm)	Liquid Pipe(mm)
GMV-224WM/B-X	Φ19.05	Φ9.52
GMV-280WM/B-X	Φ22.2	Φ9.52
GMV-335WM/B-X	Φ25.4	Φ12.7
GMV-400WM/B-X	Φ25.4	Φ12.7
GMV-450WM/B-X	Φ28.6	Φ12.7
GMV-504WM/B-X	Φ28.6	Φ15.9
GMV-560WM/B-X	Φ28.6	Φ15.9
GMV-615WM/B-X	Φ28.6	Φ15.9

Select the branch of outdoor module

	Module's capacity C (kW)	Model
Select the branch of outdoor module	$68.0 \leq C$	ML01/A

**5.5.3 Fitting pipe between two manifolds from basic modules**

Pipe size (between two manifolds from basic modules) is based on the total capacity of upstream modules.

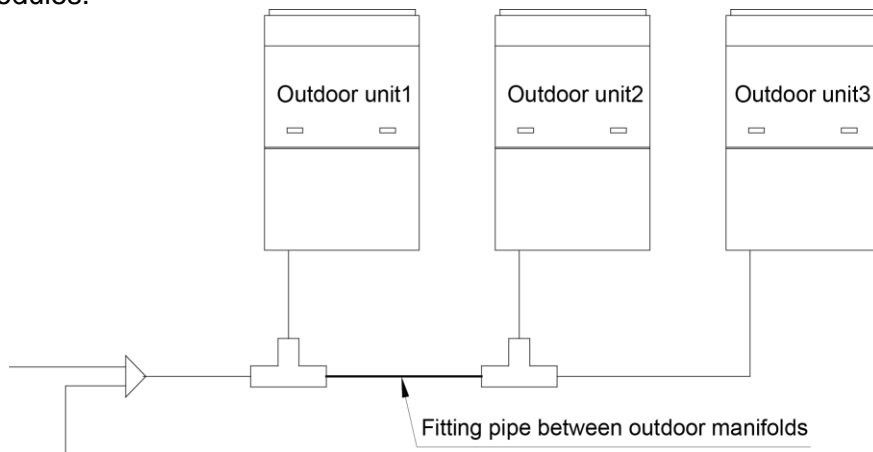

Total capacity of upstream modules Q(kW)	Pipe size between manifolds	
	Gas Pipe(mm)	Liquid Pipe(mm)
$22.4 \geq Q$	Φ19.05	Φ9.52
$28.0 \geq Q > 22.4$	Φ22.2	Φ9.52
$40.0 \geq Q > 28.0$	Φ25.4	Φ12.7
$45.0 \geq Q > 40.0$	Φ28.6	Φ12.7
$68.0 \geq Q > 45.0$	Φ28.6	Φ15.9
$96.0 \geq Q > 68.0$	Φ31.8	Φ19.05
$135.0 \geq Q > 96.0$	Φ38.1	Φ19.05
$186.0 \geq Q > 135.0$	Φ41.3	Φ19.05
$Q > 186.0$	Φ44.5	Φ22.2

**5.5.4 Fitting pipe between the first manifold from indoor unit and the end manifold from outdoor unit**  
**Single module unit**

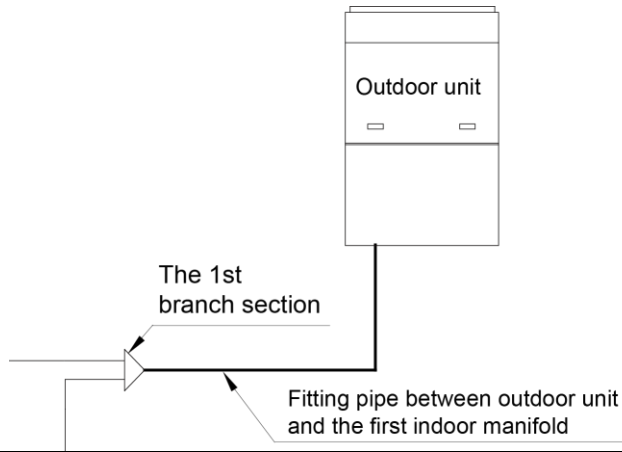

Basic Module(single module)	Pipe between ODU and the first branch of IDU	
	Gas Pipe(mm)	Liquid Pipe(mm)
GMV-224WM/B-X	Φ19.05	Φ9.52
GMV-280WM/B-X	Φ22.2	Φ9.52
GMV-335WM/B-X	Φ25.4	Φ12.7
GMV-400WM/B-X	Φ25.4	Φ12.7
GMV-450WM/B-X	Φ28.6	Φ12.7
GMV-504WM/B-X	Φ28.6	Φ15.9
GMV-560WM/B-X	Φ28.6	Φ15.9
GMV-615WM/B-X	Φ28.6	Φ15.9

For multiple modules, the piping from ODU to the first branch of IDU is based on the total rated capacity of outdoor modules.

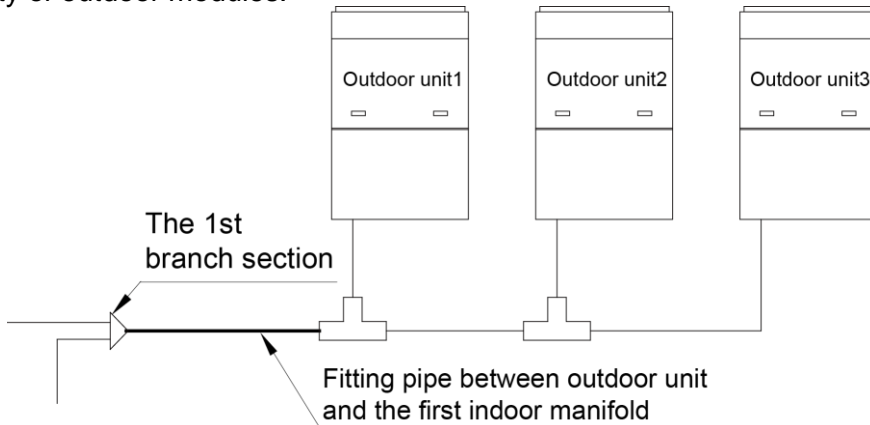

Total rated capacity of outdoor modules (multi-modular system)	Pipe between ODU and the first branch of IDU	
	Gas Pipe(mm)	Liquid Pipe(mm)
GMV-680WM/B-X	Φ28.6	Φ15.9
GMV-730WM/B-X	Φ31.8	Φ19.05
GMV-785WM/B-X	Φ31.8	Φ19.05
GMV-850WM/B-X	Φ31.8	Φ19.05
GMV-900WM/B-X	Φ31.8	Φ19.05

GMV5 DC INVERTER VRF UNITS SERVICE MANUAL

GMV-960WM/B-X	Φ31.8	Φ19.05
GMV-1010WM/B-X	Φ38.1	Φ19.05
GMV-1065WM/B-X	Φ38.1	Φ19.05
GMV-1130WM/B-X	Φ38.1	Φ19.05
GMV-1180WM/B-X	Φ38.1	Φ19.05
GMV-1235WM/B-X	Φ38.1	Φ19.05
GMV-1300WM/B-X	Φ38.1	Φ19.05
GMV-1350WM/B-X	Φ38.1	Φ19.05
GMV-1410WM/B-X	Φ41.3	Φ19.05
GMV-1460WM/B-X	Φ41.3	Φ19.05
GMV-1515WM/B-X	Φ41.3	Φ19.05
GMV-1580WM/B-X	Φ41.3	Φ19.05
GMV-1630WM/B-X	Φ41.3	Φ19.05
GMV-1685WM/B-X	Φ41.3	Φ19.05
GMV-1750WM/B-X	Φ41.3	Φ19.05
GMV-1800WM/B-X	Φ41.3	Φ19.05
GMV-1854WM/B-X	Φ41.3	Φ19.05
GMV-1908WM/B-X	Φ44.5	Φ22.2
GMV-1962WM/B-X	Φ44.5	Φ22.2
GMV-2016WM/B-X	Φ44.5	Φ22.2
GMV-2072WM/B-X	Φ44.5	Φ22.2
GMV-2128WM/B-X	Φ44.5	Φ22.2
GMV-2184WM/B-X	Φ44.5	Φ22.2
GMV-2240WM/B-X	Φ44.5	Φ22.2
GMV-2295WM/B-X	Φ44.5	Φ22.2
GMV-2350WM/B-X	Φ44.5	Φ22.2
GMV-2405WM/B-X	Φ44.5	Φ22.2
GMV-2460WM/B-X	Φ44.5	Φ22.2

### 5.5.5 Manifold at indoor unit side

Manifold at indoor unit side can be selected as per total capacity of downstream indoor unit(s). Refer to the following table.

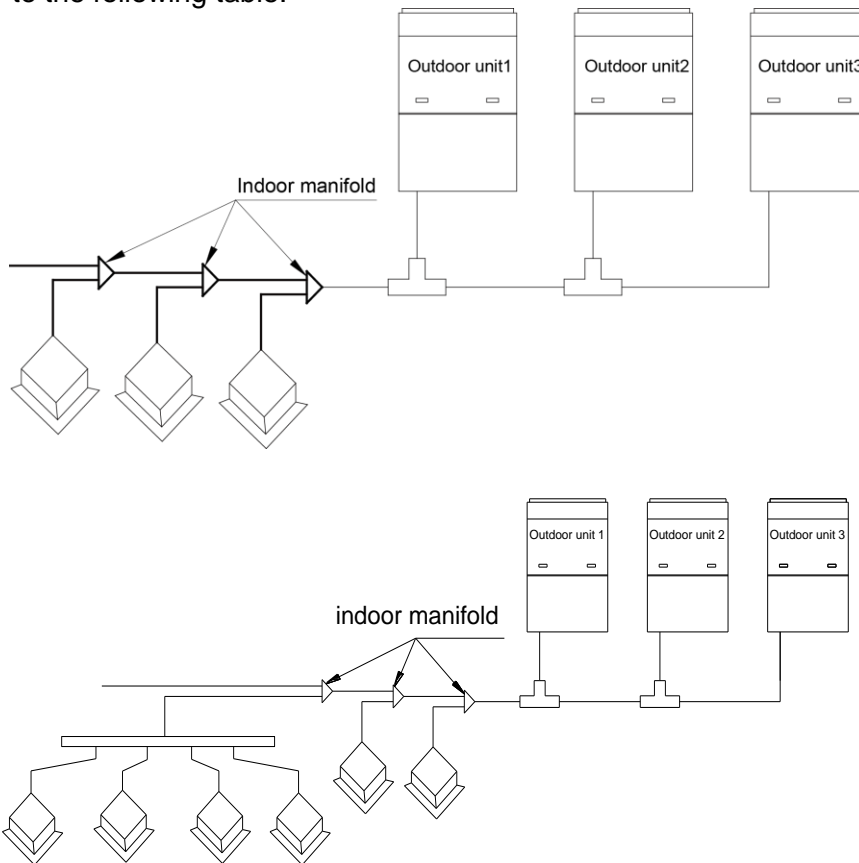

R410A Refrigerant System	Total capacity of downstream indoor unit(s) C (kW)	Model
Y-type Manifold	$C < 20.0$	FQ01A/A
	$20.0 \leq C \leq 30.0$	FQ01B/A
	$30.0 < C \leq 70.0$	FQ02/A
	$70.0 < C \leq 135.0$	FQ03/A
	$135.0 < C$	FQ04/A
T- type Manifold	$C \leq 40.0$	FQ014/H1
	$40.0 < C \leq 68.0$	FQ018/H1
	$68.0 < C$	FQ018/H2

**5.5.6 Fitting pipe between manifolds**

Pipe size (between two manifolds at indoor unit side) is based on the total capacity of upstream indoor unit(s).

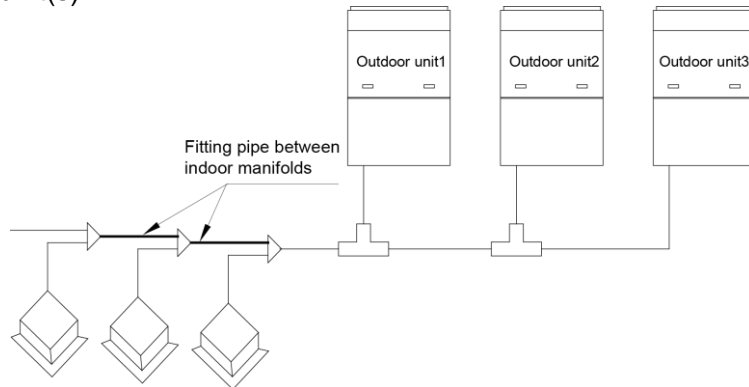

Total Rated Capacity X(kW) of Downstream Indoor Units	Fitting Pipe Size between Indoor Manifolds	
	Gas Pipe (mm)	Liquid Pipe (mm)
$C \leq 5.6$	Φ12.7	Φ6.35
$5.6 < C \leq 14.2$	Φ15.9	Φ9.52
$14.2 < C \leq 22.4$	Φ19.05	Φ9.52
$22.4 < C \leq 28.0$	Φ22.2	Φ9.52
$28.0 < C \leq 40.0$	Φ25.4	Φ12.7
$40.0 < C \leq 45.0$	Φ28.6	Φ12.7
$45.0 < C \leq 68.0$	Φ28.6	Φ15.9
$68.0 < C \leq 96.0$	Φ31.8	Φ19.05
$96.0 < C \leq 135.0$	Φ38.1	Φ19.05
$135.0 < C \leq 186.0$	Φ41.3	Φ19.05
$186.0 < C$	Φ44.5	Φ22.2

**5.5.7 Fitting pipe between indoor unit and manifold**

Manifold should be matched with fitting pipe of indoor unit.

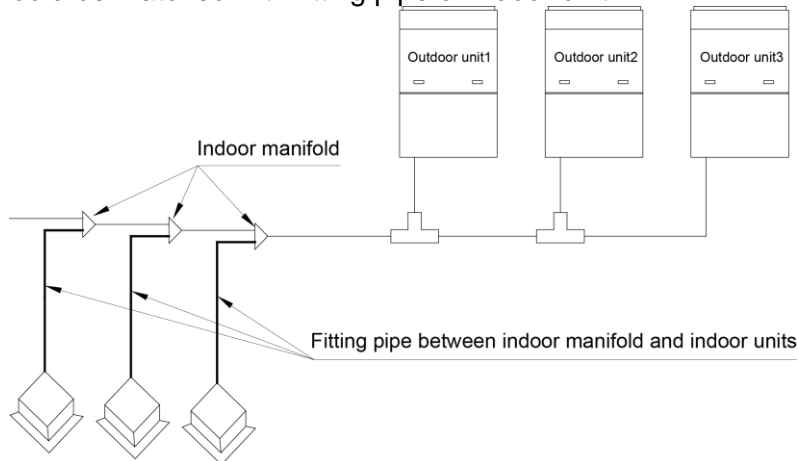

Rated capacity of indoor unit C(kW)	Pipe between indoor branch and IDU	
	Gas Pipe(mm)	Liquid Pipe(mm)
$C \leq 2.8$	Φ9.52	Φ6.35
$2.8 < C \leq 5.0$	Φ12.7	Φ6.35
$5.0 < C \leq 14.2$	Φ15.9	Φ9.52
$14.2 < C \leq 22.4$	Φ19.05	Φ9.52
$22.4 < C \leq 28.0$	Φ22.2	Φ9.52

# 6 Pipe Installation and Insulation

## 6.1 Pipe Installation for the Cooling System

### 6.1.1 Precautions on Pipe Direction Design

Refrigerant pipe layout must be designed in accordance with the following principles:

1) The air conditioning installation should not damage the bearing structure or the decorative style. Air conditioning pipes should be laid out along the bottom of beam as possible. If pipes meet one another at the same elevation, process based on the following principles:

Drain pipes enjoy the highest priority. Air ducts and pressure pipes should leave places for gravity pipes.

Air ducts and small pipes should leave places for major pipes.

2) The refrigerant pipe layout must be optimal in actual engineering with minimum pipe length and bends. In this way, the performance of the unit can be maximized.

3) The refrigerant pipe cannot affect air discharge and return of internal units. The minimum distance between the refrigerant pipe with an insulation layer and the air return box is 300 mm. If the air return or manhole is at the right lower part of the unit, the minimum distance is 150 mm. When the refrigerant pipe needs to be laid at the air outlet side, avoid laying the pipe at the front of the air outlet. The refrigerant pipe cannot connect to any part of the unit except the joint points. If the preceding principles are not followed, performance of the unit will be affected and running noises will be increased.

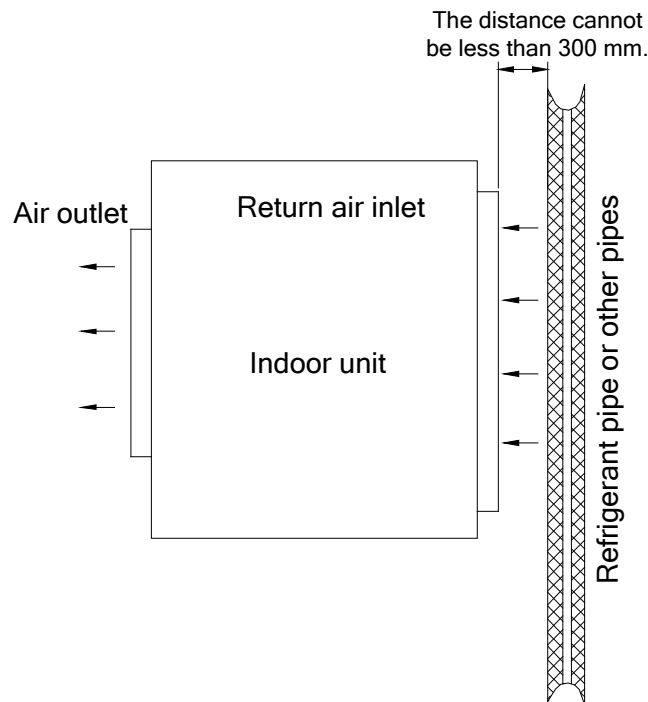

4) The refrigerant pipe must be laid away from the manhole of the unit so that sufficient space can be reserved for maintenance.

5) The riser should be installed in the air conditioning tube well, and the horizontal pipe should be placed in the ceiling, if possible.

### 6.1.2 Processing to Refrigerant Pipes

#### 6.1.2.1 Cut-off and Burring

Use a special-purpose pipe cutter to cut copper pipes instead of using a hacksaw.

Cut the pipes gently to ensure that the copper pipe does not deform.

After cutting the pipes, use a slicker to grater bur the pipes with the pipe opening inclining downward so that the copper scales do not fall into the pipe.

Allowable deviation: Skewness of the cross section cannot exceed 1% of the copper pipe caliber.

If the copper pipe is not used immediately after cut-off, cover it with a sealing cap or adhesive tape.

### 6.1.2.2 Pipe Cleaning

Cleaning with a piece of silk cloth: Wrap a thin steel wire with a piece of clean silk cloth. Crumple the cloth into a lump with diameter larger than the pipe calibre. Apply several drops of chlorylene to the cloth. Push the cloth in from one end of the pipe and pull out from the other end. Every time the cloth is pulled out, remove the dust and sundries with chlorylene. Wash repeatedly until the pipe is clean. This method applies to straight pipes.

Cleaning with nitrogen: Blow off all dust and sundries in the pipe with nitrogen. This method applies to coils.

After cleaning, cover the both ends of the pipe with a sealing cap or adhesive tape.

### 6.1.2.3 Pipe Bending

Processing methods:

Manual bending: applies to thin copper pipes ( $\Phi 6.35$  mm to  $\Phi 12.7$  mm)

Mechanical bending: applicable range ( $\Phi 6.35$ mm to  $\Phi 54.1$ mm)

Requirements:

The radius of the bending pipe must exceed  $3.5D$ . The ratio of the short diameter after bending to the original diameter must exceed  $2/3$ .

Precautions:

During bending, there must be no corrugation or deformation inside the pipe.

The welding point of the pipe should not be at the bending part. The distance between the nozzle welding joint and the bending part should be less than 100 mm.

### 6.1.2.4 Pipe Expanding

Pipe expanding is used to provide a welding point for pipe connection. Requirements on pipe expanding are as follows:

- All burrs and sundries inside the pipe must be cleared after cut-off.
- Before pipe expanding, apply appropriate amount of lubricant on the surface of the pipe. (The lubricant must meet the refrigerant system's requirements.)
- Pipe expanding length must be in accordance with the insertion depth of the caliber.
- To avoid leakage due to straight lines at the expanding point, turn round the copper pipe and then make corrections.
- Apply appropriate force during pipe expanding to avoid crack.

### 6.1.2.5 Flaring

Another mode of pipe connection is flare opening connection, which requires pipe flaring before connection. Before pipe flaring, apply appropriate amount of lubricant on the surface of the opening to ensure smooth pass of flaring nuts and avoid pipe distortion. (The lubricant must meet the refrigerant system's requirements.) The concentricity must be ensured after pipe flaring. The sealing face must be intact without any burr, crack, or wrinkle.

Requirements on pipe flaring are as follows:

- End faces of the copper pipe are smooth.
- Burrs and turnups inside the pipe opening must be cleared.
- Install flaring nuts in the pipe before pipe flaring.
- The flared opening must be concentric with the main pipe. No eccentricity is allowed.
- Put the pipe into the root of the pipe expander.
- Longitudinal cracks cannot be generated.

## 6.1.3 Installation of Refrigerant Pipes

### 6.1.3.1 Operation Sequence

The sequence for installing the refrigerant pipe is as follows:

Preparing and installing the support, hanger, and bracket – Piping according to the drawing – Cleaning the pipe – Processing the pipe – Adding an insulation sleeve – Connecting the pipe – Fixing the pipe – Blowing contaminants in the pipe system – Performing an air-tightness test – Performing insulation

### 6.1.3.2 Construction of Built-in Metal Fittings

- Construction of supports, hangers, and brackets for pipes: These parts must be fixed securely in reasonable type and style without any tilt. The surface is clean without any dirt. The parts embedded into the wall or floor cannot be painted or coated and must be free from grease stains.
- Construction of fixing bolts for devices: Ensure sufficient rigidity for the devices. Take anticorrosive measures for exposed part of built-in fittings. If the foundation must be waterproof, takes waterproof measures.
- Construction of steel casings: Equip a steel casing for all pipes which are led through the wall or floor. Pipe welding joints cannot be placed inside the sleeve. The steel casing

must be parallel with the bottom of the wall or floor but be 20 mm or more above the bottom. The diameter of the steel casing must be determined based on the thickness of the insulation layer and the inclination degree of the condensate water pipe. Fill the gap between the pipe and the sleeve with flexible and non-flammable materials. The sleeve cannot be used as a support point of the pipe.

d) Operation Sequence

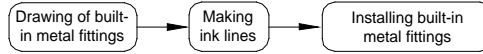

If possible, make ink lines on the ground and project them to the top of the building.

e) Installing Built-in Metal Fittings

Select built-in metal fittings in accordance with local regulations.

f) Installing Expansion Bolts

Use expansion bolts when built-in metal fittings are unavailable due to design change.

g) Installing Expansion Bolts

If the foot pedal is 2 m or more from the ground, there must be three points of support.

The foot pedal must be tightened securely with the ladder.

Do not perform operations on the top of the ladder.

6.1.3.3 Shaping and Fixing of Pipes

When installing refrigerant pipes, ensure that the directions and branches are correct with minimum length. Use minimum number of braze welding junctions and elbows. Alignment and insulation after installation cannot affect the pipe location and elevation. There shall not be flat bending or corrugation on the pipe after piping.

Use angle steel support, bracket, round steel hanger, U-type pipe clip, or flat steel to fix pipes outside the insulation layer. It is better that the insulation materials be not compressed to ensure good insulation.

The style and workmanship of supports, hangers, and brackets must follow the standard T616 HVAC Systems Design Handbook.

The minimum distance between supports, hangers, and brackets is listed in the table below:

External Diameter of the Pipe (mm)	$\phi \leq 16$	$40 > \phi \geq 19.05$	$\phi \geq 40$
Distance between Horizontal Pipes (mm)	1000	1500	2000
Distance between Vertical Pipes (mm)	1500	2000	2500

The pipe led through a wall or beam must be fixed by a support, hanger, or bracket on both ends at the position 300 mm away from the hole.

6.1.3.4 Pipe Connection

a) Flaring Connection

The refrigerant pipes and IDUs are connected by using the flare opening. Therefore, the quality of flaring connection must be ensured. The flaring depth of the bell mouth cannot be smaller than the caliber. The flaring direction must face towards the direction of medium flow. Use two torque wrenches to fasten the connection

b) Socket Welding

The gap between socket components should be proper to ensure that the connection will not loose from the friction surface. The flaring direction of the socket component must face towards the direction of medium flow. During pipe connect, protect the braze welding part according the length specified below:

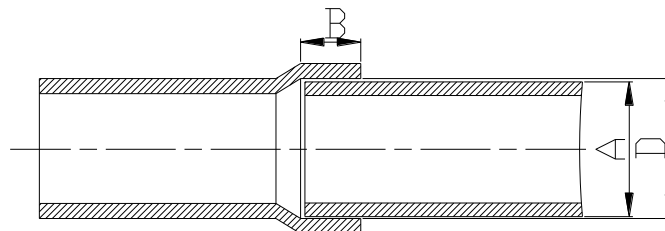

A: External Diameter of the Pipe (mm)	B: Minimum Insertion Depth (mm)	D-A: Gap between Pipes (mm)
$\phi 6.35$	6	0.05-0.21
$\phi 9.52$	7	



φ12.7		
φ15.8	8	0.05-0.27
φ19.05 φ22.2 φ25.4	10	
φ28.6, φ31.8	12	
φ38.1 φ44.5	19	0.15-0.35
φ54.1	24	0.15-0.35

c) Bell Socket Welding

The bell socket welding is another form of socket welding. It uses the sleeve or pipe in a larger size for welding. The insertion depth cannot be smaller than that required by socket welding.

d) 3.4.5 Flange Connection

The pipes with large caliber and the devices are always connected by using a flange, which must be clean and intact. Before installation, apply lubricant on the surface of the flange. Two flanges must be symmetrical. Fasten with screws at the diagonal direction to avoid inclination.

6.1.3.5 Welding Protection

Aerate with nitrogen before and during welding and keep aerating for 30 s after the welding is finished.

Equip a pressure regulator valve to the nitrogen cylinder.

The nitrogen flow is above 4-6 L/min (pressure of 0.02 to 0.05 MPa) and must be regulated based on the pipe caliber.

6.1.3.6 Requirements on Manifold Installation

Manifolds are used to divert refrigerant. Requirements on manifold installation are as follows:

A. Ensure that the manifold is close to the IDU to reduce impact on refrigerant assignment by IDU branches.

B. The manifold must be that specified by the manufacture and match with the devices.

C. Ensure that the manifold model is correct.

D. If the outdoor unit is connected with several indoor units, you can also adopt Y-type manifold pipe. Please comply with the following rules when connecting T-type manifold pipe and Y-type manifold pipe. The downstream of Y-type manifold pipe can connect with T-type manifold pipe, but the downstream of T-type manifold pipe cannot connect with Y-type manifold pipe.

E. Y-type manifold can be laid in the following ways:

E1. Horizontal installation: The three ports must be on the same level. The shaping size and assembly angle cannot be changed.

E2. Vertical installation: The direction can be upwards or downwards. Three ports must be on the same elevation without inclination.

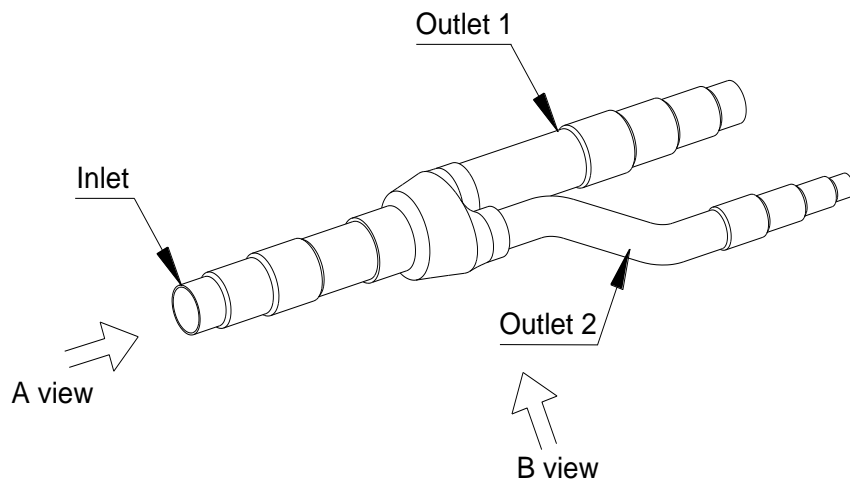

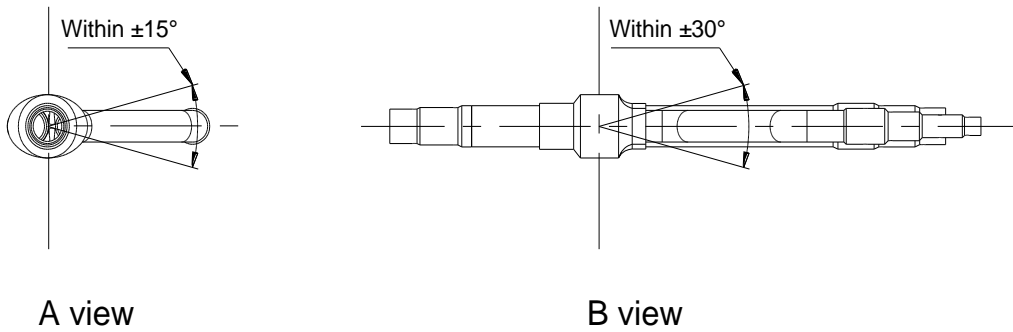

- E3. The length of a straight pipe between two manifolds cannot be less than 500 mm.
- E4. The length of a straight pipe before the main pipe port of the manifold cannot be less than 500 mm.
- E5. The length of a straight pipe between the branch of the manifold and the IDU cannot be less than 500 mm.

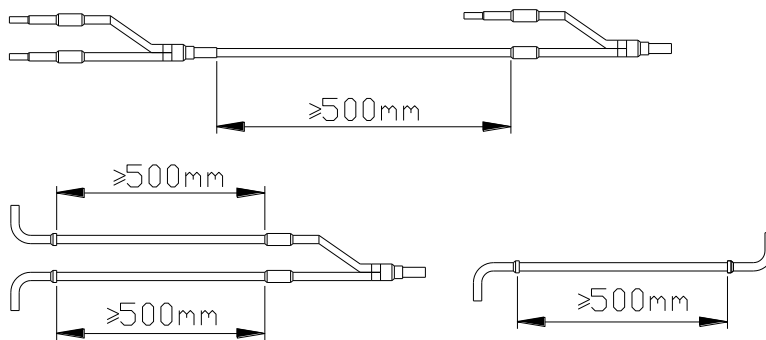

- E6. Fixing of manifolds:  
 There must be three fixing point for both horizontal and vertical installation of the Y-type manifold.
- Fixing point 1: 100 mm on the main inlet manifold from the welding point
  - Fixing point 2: 200 mm on the main branched pipe from the welding point
  - Fixing point 3: 250 mm on the branched pipe from the welding point

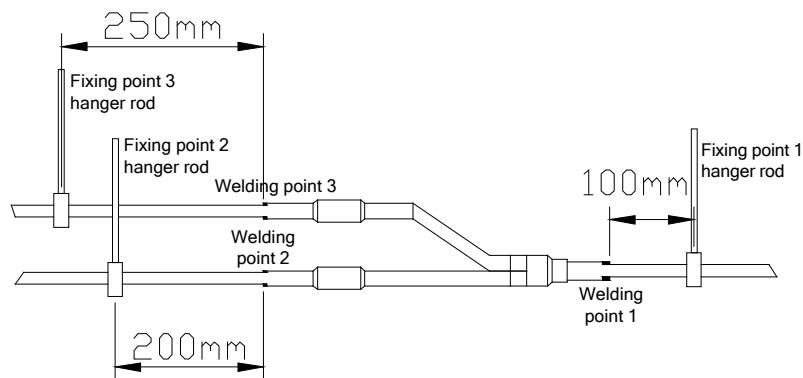

- Branches of a manifold must be laid parallel and cannot be wrapped in superimposed mode.
- F. T-type manifold can be laid in the following ways:
- F1. T-type manifold must be installed horizontally with inclination.

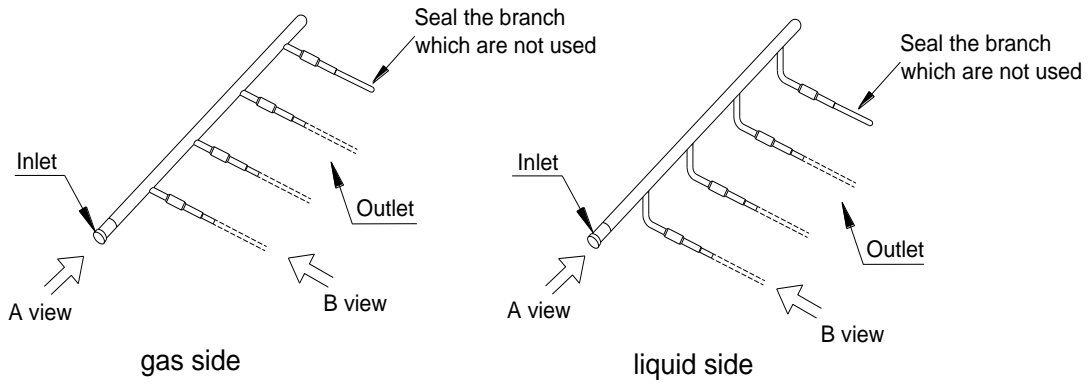

A view

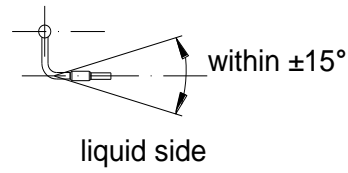
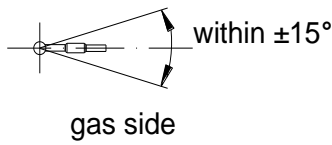

B view

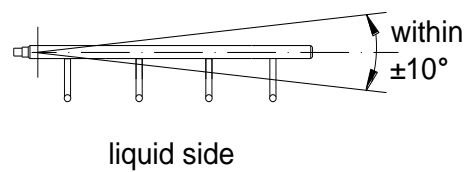
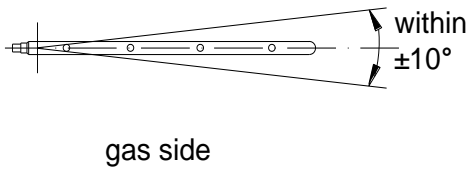

F2. The length of a straight pipe between T-type manifold pipe and Y-type manifold pipe cannot be less than 500 mm.

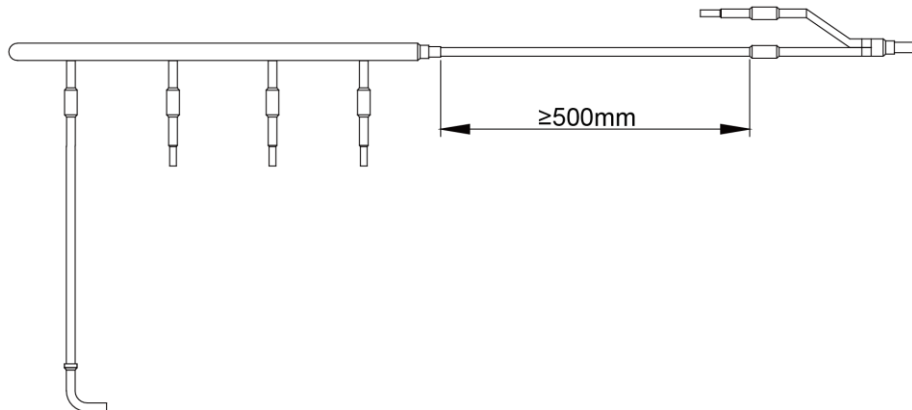

F3. The length of a straight pipe between the T-type manifold pipe and the IDU cannot be less than 500 mm.

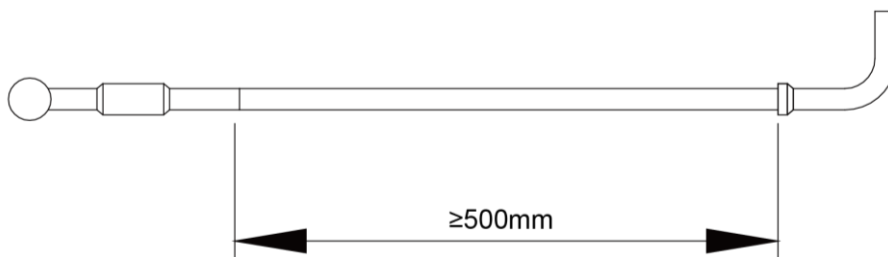

F4. Suspend the header to the ceiling and be sure to install it so that the outlet pipes are

horizontal at the lower side.

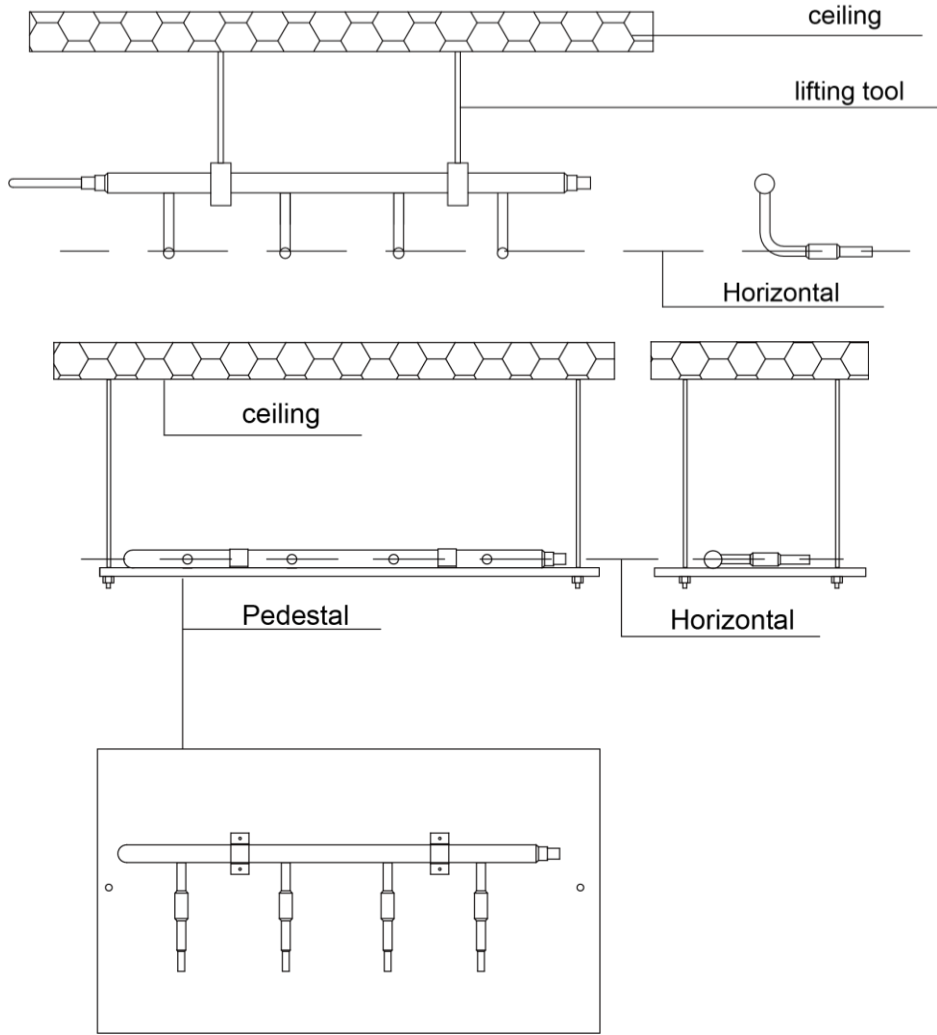

F5. The downstream of T-type manifold pipe cannot connect with Y-type manifold pipe and T-type manifold pipe

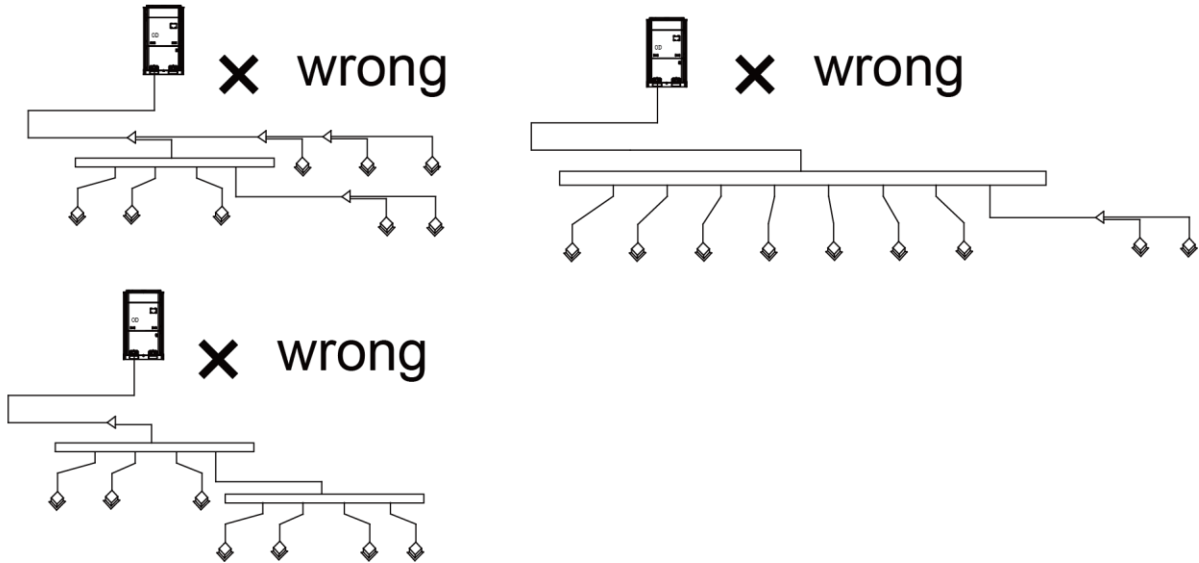

Equivalent length of one Y-type manifold pipe is about 0.5m.  
 Equivalent length of branch of IDU is 0.5m.

F6. Min & Max Number IDUs connectable with each T-Type manifold pipe

	Min Number IDUs	Max Number IDUs
FQ14/H1	2	4
FQ18/H1	4	8
FQ18/H2	4	8

Max Indoor Unit Capacity connectable is 14kW. If T-Type manifold pipe connectable Indoor Unit Capacity satisfy demand  $14\text{KW} < \text{Indoor Unit Capacity} \leq 16\text{KW}$ , follow need to supply also Reducer / Expander Pipe to connect furthermore gas pipe: pipe size transition  $\Phi 15.9\text{mm}$  to  $\Phi 19.1\text{mm}$ .

G. The liquid pipe and gas pipe must have the same length and be laid in the same route.

H. The manifold has an attached pipe used to adjust the diameter of different pipes. If the pipe size on site does not match the size of the manifold junction, use the pipe cutter to cut at the middle of the pipe and remove burrs. Then insert the copper pipe to proper depth. A concave bag for positioning is available to the manifold purchased from Gree.

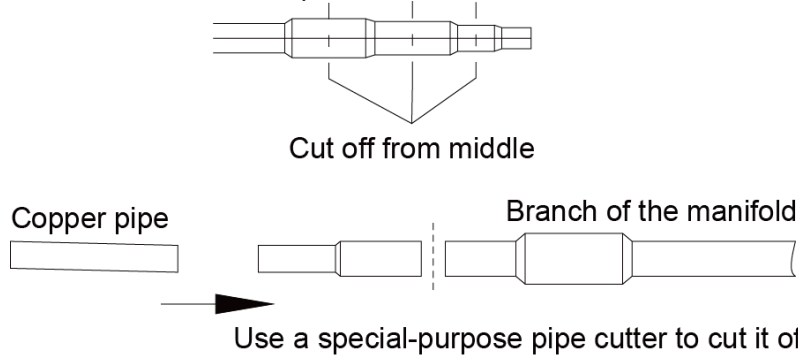

I. Because the manifold structure is complex, perform with care to ensure tight insulation.

#### 6.1.3.7 Pipe Cleaning by Nitrogen

Before connecting the flare opening of the pipe to the IDU, connect the pressure regulator valve on the nitrogen cylinder to the liquid pipe in the outdoor pipe system. Regulate the nitrogen pressure to about  $5 \text{ kgf/cm}^2$  and blow nitrogen into the pipe for 1 minute. Repeat this operation for three times till the dirt and water are discharged. After cleaning the liquid pipe, perform the same operation to clean the gas pipe.

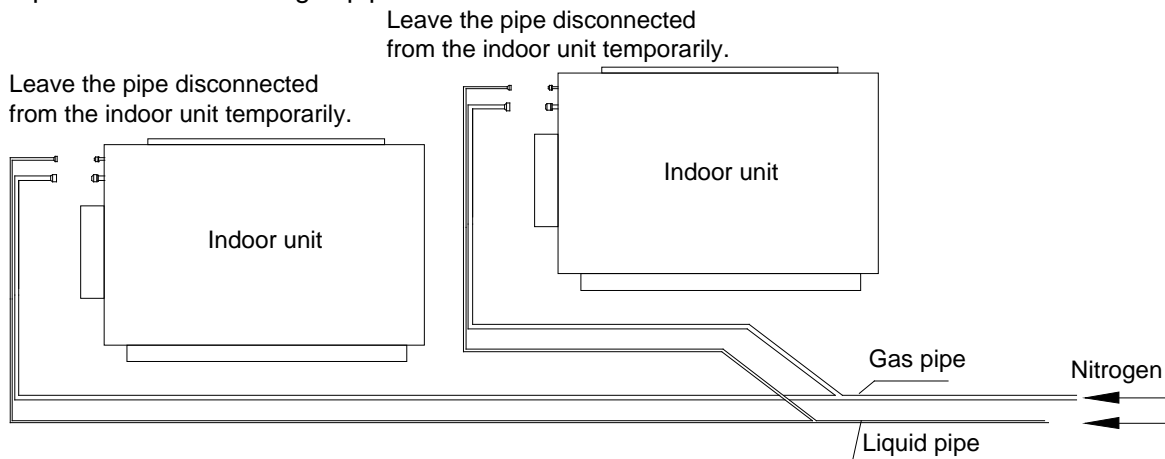

Perform an air-tightness test and a vacuum test to the entire refrigerant pipe system after the construction is finished.

There must be a secure distance between pipes. Pipes in different types must be fixed separately.

6.1.3.8 During refrigerant pipe installation, ensure a distance above 500 mm between the pipe and the electric box of the unit for maintenance. In a case when the space is not enough, the final piping way must be determined by the technical personnel.

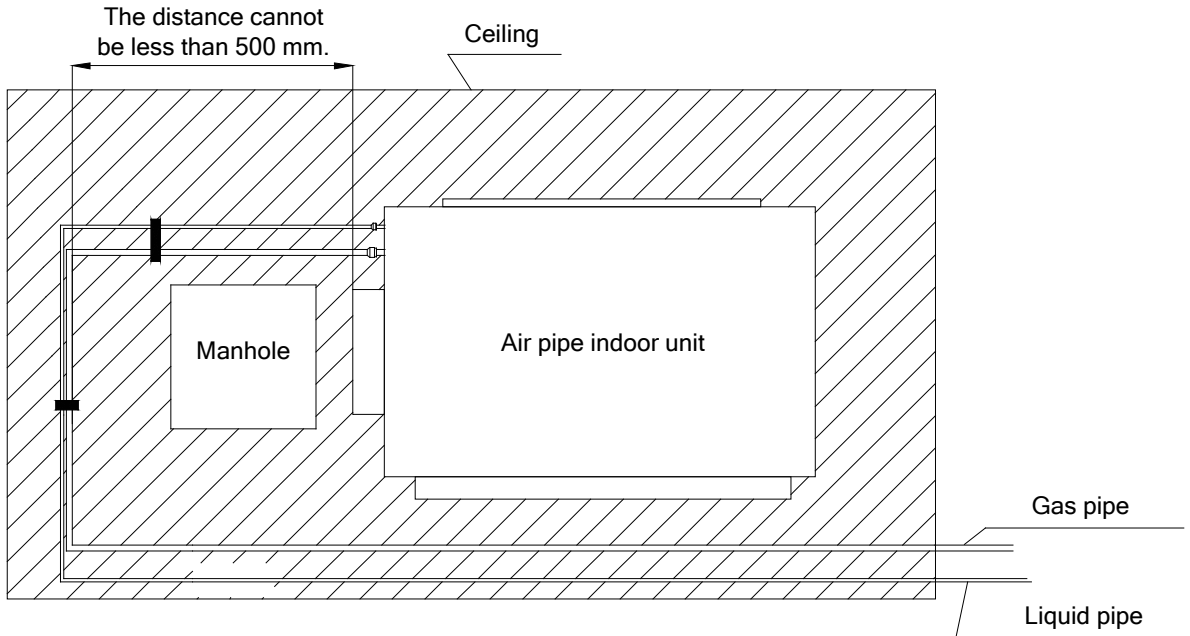

6.1.3.9 Filter and Drier Installation for the ODU

As the piping for the VRF system is complex, it is recommended that a filter is installed for the gas pipe and a drier is installed for the liquid pipe during construction. This ensures aridity and cleanness of the piping system and further improves the operation stability of the system.

The procedure is as follows:

First, weld a stop valve with the corresponding caliber to the gas pipe and liquid pipe at the position relatively close to the ODU and easy for operation.

Second, install a filter (100 mesh/ft<sup>2</sup>) between the added stop valve outside the gas pipe and the stop valve of the ODU. Then install a drier filter between the added stop valve outside the liquid pipe and the stop valve of the ODU.

Lastly, after the test run is complete,

To remove the filter from the gas pipe after starting all IDUs and keeping them running cooling mode for 24 hours: (1) Power off all units. (2) Turn off the two stop valves of the gas pipe. (3) Remove the filter. (4) Short connect with a copper pipe with the same caliber and vacuumize the pipe. (5) Open the two stop valves and keep normal running.

To remove the drier filter from the liquid pipe after starting all IDUs and keeping them running in heating mode for 24 hours: (1) Power off all units. (2) Turn off the two stop valves of the liquid pipe. (3) Remove the drier filter. (4) Short connect with a copper pipe with the same caliber and vacuumize the pipe. (5) Turn on the two stop valves and keep normal running.

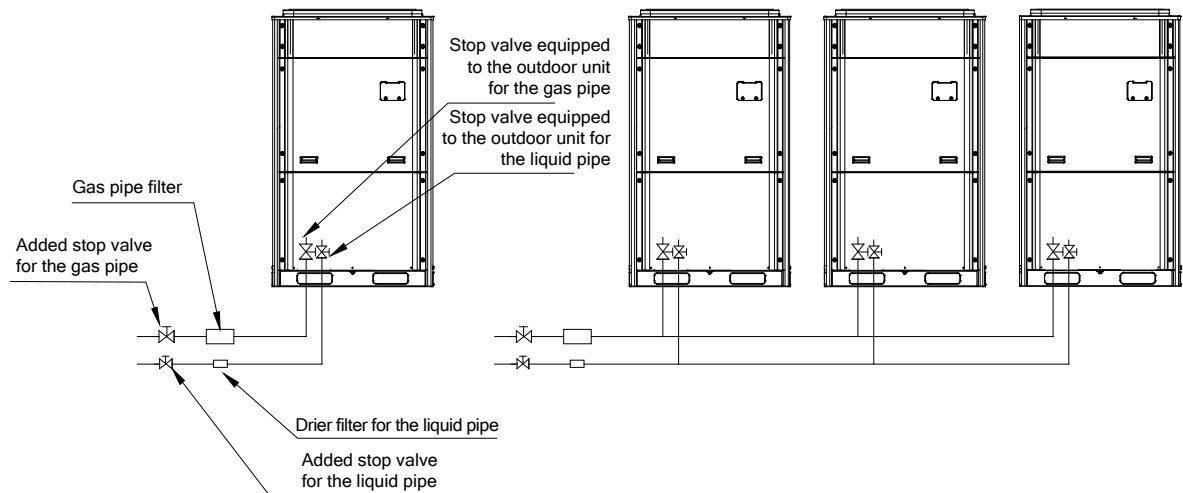

# 6.2 Pipe Installation for the Condensate Water System

## 6.2.1 Pipes

Generally, U-PVC water supply pipes bonded with special glue are adopted as condensate water pipes. PP-R, PP-C, and hot galvanized steel pipes can also be adopted. Aluminium plastic compound pipes cannot be used.

## 6.2.2 Requirements on Installation

6.2.2.1 Determine the direction and elevation of a condensate water pipe before installing it. Avoid overlapping it with other pipes to ensure straight inclination. The clamp of the pipe hanger is fixed outside the insulation layer. The height of the clamp can be adjusted.

### 6.2.2.2 Distance between Hangers

External Diameter of the Pipe (mm)	$\Phi \leq 25$	$32 > \Phi \geq 25$	$\Phi \geq 32$
Distance between Horizontal Pipes (mm)	800	1000	1500
Distance between Vertical Pipes (mm)	1500		2000

There are at least two hangers for each vertical pipe.

6.2.2.3 The inclination degree of the condensate water pipe must be above 1% and that of the main pipe cannot be lower than 0.3%. Adverse slopes are not allowed.

6.2.2.4 When connecting three-way pipes, the two-way straight pipes must be laid on the same slope, as shown in the following figures.

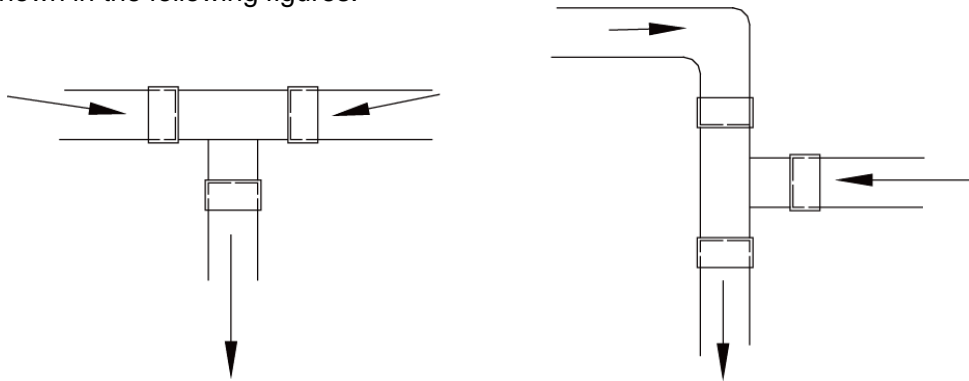

Incorrect connection

Correct connection

6.2.2.5 The condensate water pipe cannot be tied with the refrigerant pipe.

6.2.2.6 A ventilation hole must be provided on the top of the drain pipe to ensure smoother discharge of condensate water.

6.2.2.7 After pipes are connected, perform a test with some water and another test with full water in the pipe to check whether drainage is smooth and whether water leakage exists in the pipe system.

6.2.2.8 Equip a steel casing for all pipes which are led through the wall or floor. Pipe bonding joints cannot be placed inside the sleeve. The steel casing must be parallel with the bottom of the floor or wall. There must be a height drop of 20 mm from the ground when the pipe is lead through the floor. The sleeve cannot affect the inclination degree of the pipe. Fill the gap between the pipe and the sleeve with flexible and non-flammable materials. The sleeve cannot be used as a support point of the pipe.

6.2.2.9 Bond the insulation material joints with special glue and then wrap them with plastic adhesive tape. The width of the adhesive tape must be 5 cm or more to prevent dewing.

## 6.2.3 Other Requirements

6.2.3.1 Ensure an inclination degree of more than 1% when connecting the drain pipe to the IDU.

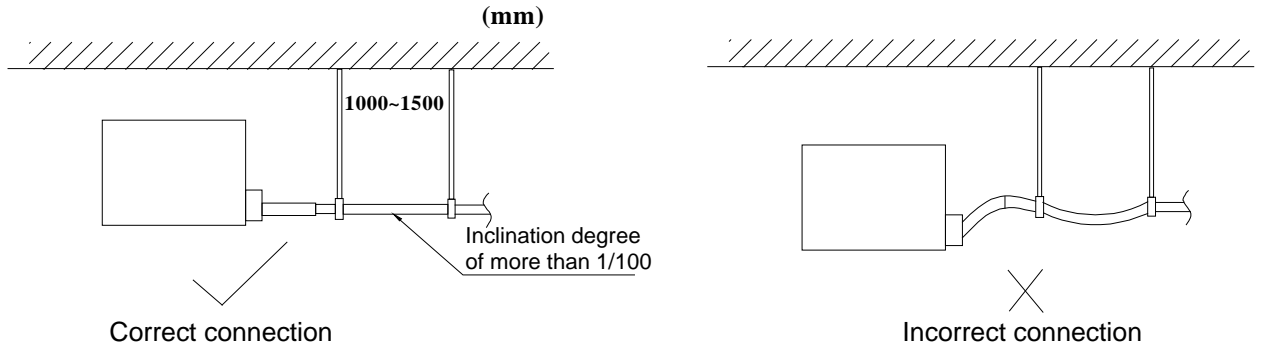

6.2.3.2 When connecting the drain pipe to that of the IDU, fix the pipes with the bands provided upon delivery instead of using the glue to facilitate further maintenance.

6.2.3.3 When connecting the drain pipe branches to the main pipe, lead through from the above part of the main pipe.

6.2.3.4 If the air volume of the IDUs is high and outdoor air resorption may be caused by negative suction pressure, provide a u-type drain trap at the water outlet side of each IDU, as shown in the following figure.

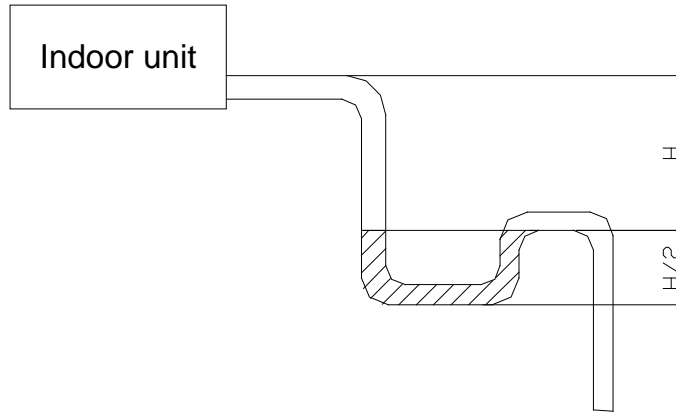

- ◆ Install drain trap connectors as shown in the following figure.
- ◆ Install a drain trap connector for each unit.
- ◆ The drain trap connector shall be installed in a way that facilitates trap cleaning.

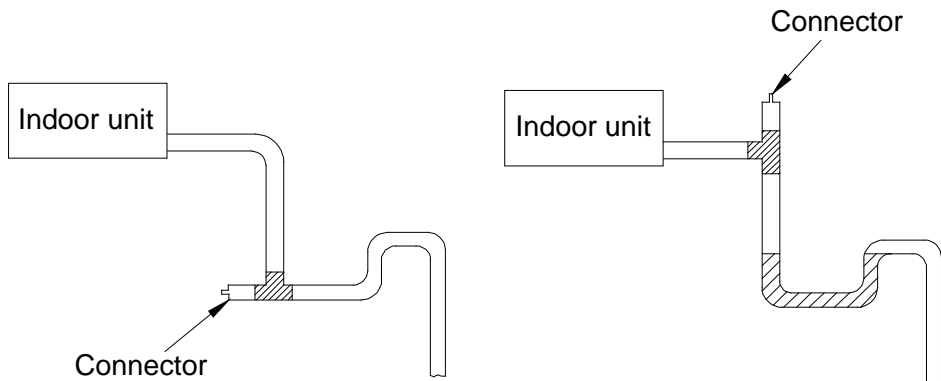

6.2.3.5 During condensate water pipe installation, ensure a distance above 500 mm between the pipe and the electric box of the unit for maintenance. In a case when the space is not enough, the final piping way must be determined by the technical personnel.

#### 6.2.4 Requirements on Installation of Drain Pipes for Different Types of IDUs

6.2.4.1 Drain Pipe Installation for Hidden Air-duct-type IDU for Air Supply



- a) Ensure an inclination degree of greater than 1% when connecting the drain pipe to the IDU.
- b) When connecting the drain pipe to that of the IDU, fix the pipes with the bands instead of using the glue to facilitate further maintenance.
- c) There is a condensate water outlet on both sides of the IDU. After one condensate water outlet is determined, use the rubber stopper to block the other outlet. Tie it with threads and strap with insulation materials to prevent leakage.
- d) The connection between the drain pipe and that of the IDU is shown in the following figure.

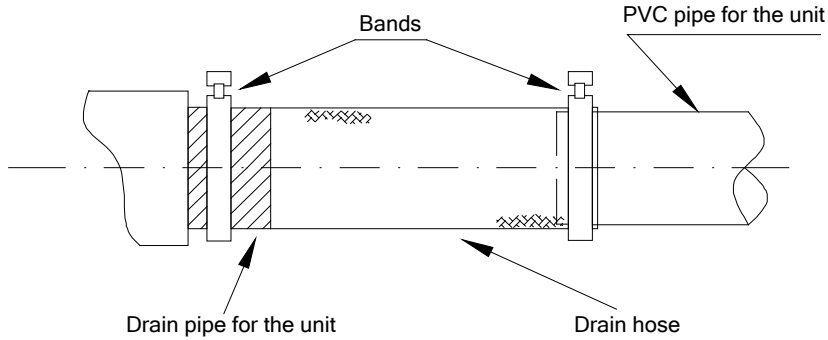

- e) Apply insulation materials to the condensate water pipe joints to prevent dewing. Insulation for connection between the drain pipe and that of the IDU is shown in the following figure.

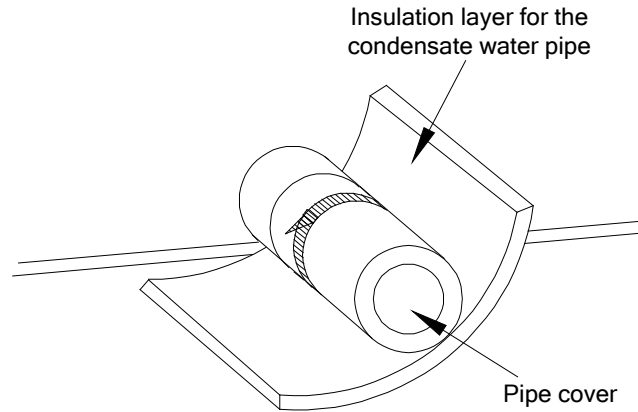

#### 6.2.4.2 Drain Pipe Installation for IDU

- a) Use pipe clips instead of applying glue to connect the hoses provided upon delivery and plastic pipes on the device. Connect the other end of the joint to the elbow. The height from the suction inlet of the discharge pump is about 200 to 500 mm. Ensure a proper inclination degree while connecting to the main drain pipe.
- b) The lifting pipe for drainage must be provided as shown in the following figure.

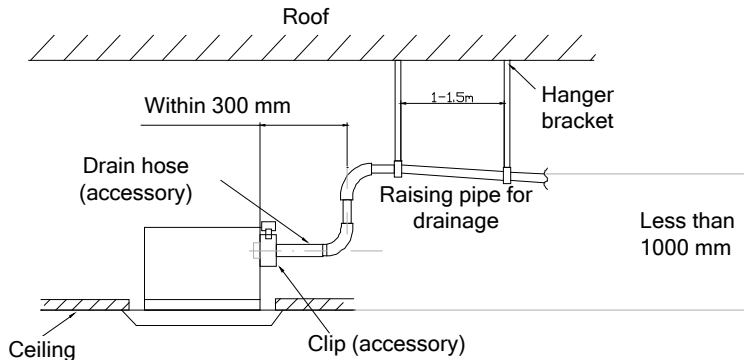

- c) The drain pump shall be fixed securely. Otherwise, abnormal noises will be generated.

#### 6.2.5 Requirements on Independent Drainage for Each IDU

Requirements on independent drainage design for each IDU are as follows:

- a) There must be a proper inclination for the drain pipe.
- b) The drain pipe must be installed to facilitate drainage to the largest extent and be as short as possible.
- c) If the water is discharged to the outdoor side, it cannot drop to the outdoor ground directly.

#### **6.2.6 Requirements on Centralized Drainage for IDUs**

- a) When there are multiple IDUs in the same building, centralized drainage is adopted.
- b) When a header pipe is used, the drain pipe of each IDU must be higher than the header pipe.
- c) The diameter of the header pipe must be determined on the number and capacity of IDUs.
- d) When installing pipe, start from the highest point of the pipe and follow the specified inclination to smoothly discharge condensate water.
- e) Connect branches to the main pipe from the upper part or side instead of lower part of the main pipe.
- f) Insulate all condensate water pipes, especially for joints at elbows.

## 6.3 Insulation System

### 6.3.1 Insulation for the Refrigerant Pipe System

#### 6.3.1.1 Insulation Materials

Use closed-cell foam insulation materials with flame retardant grade of B1.

The heat conductivity is not greater than 0.035 w/(m·k) when the average temperature is 0°C.

#### 6.3.1.2 Thickness of the Insulation Layer

External Diameter of the Pipe (mm)	≤ 12.7	≥ 15.88
Thickness of the Insulation Layer (mm)	≥ 15	≥ 20

Use sunblock, anti-weathering, and non-cracking insulation materials for outdoor pipes.

#### 6.3.1.3 Procedure of Insulation

- Select insulation materials based on design requirements.
- Wear the insulation sleeve before connecting refrigerant pipes. Users cannot cut the insulation material apart and then wrap up with ties after connecting the pipes by welding.
- Specifications of the insulation sleeve must match with that of the refrigerant pipes.
- Reserve a distance of about 200 mm near the welding point to protect the insulation sleeve during welding. After performing the air-tightness test, perform insulation to the welding point separately to ensure continuity of the insulation sleeve.
- The insulation layer cannot crack during construction. Bond the insulation material joints with special glue and then wrap them with electrical adhesive tape. The width of the adhesive tape must be 50 mm or more to ensure secure connection.
- Use glue to bond the insulation material at the water outlet to the unit to prevent dewing.
- Wrap joints of indoor/outdoor units with insulation materials. There must be no gap between the joint and the wall of the indoor/outdoor unit, as shown in the following figure.

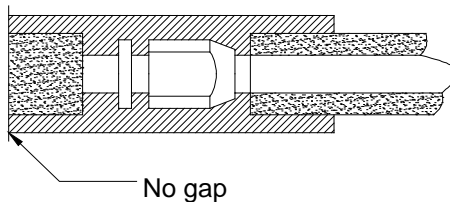

### 6.3.2 Insulation for the Condensate Water Pipe System

#### 6.3.2.1 Insulation Materials

Use closed-cell foam insulation materials with retardant grade of B1.

The heat conductivity is not greater than 0.035 w/(m·k) when the average temperature is 0°C.

#### 6.3.2.2 Thickness of the Insulation Layer

Thickness of the insulation layer for the condensate water pipe must be greater than 10 mm.

6.3.2.3 Bond the insulation material joints with special glue and then wrap them with plastic adhesive. The width of the adhesive must be greater than 5 cm to prevent dewing.

6.3.2.4 Insulation is not required for the outdoor part of condensate water pipes.

### 6.3.3 Insulation for Air Ducts

6.3.3.1 Insulation for air duct components and devices must be performed after the air leakage test is performed or after quality check.

6.3.3.2 Use centrifugal glass wool or rubber and plastic materials for insulation or use novel insulation air ducts.

6.3.3.4 The insulation layer should be flat and tight without any crack or gap.

#### 6.3.3.5 Thickness of the Insulation Layer

For the air supply and return air pipe laid in a room without an air conditioner, thickness of the rubber and plastic insulation layer is 35 mm.

For the air supply and return air pipe laid in an air conditioning room, thickness of the rubber and plastic insulation layer is 20 mm.

6.3.3.6 Supports, hangers, and brackets of the air duct must be installed outside the insulation layer. A chock must be provided between the support, hanger, or brackets and the air duct.

# 7 Electric and Controller Installation

## 7.1 Precautions

Both the power cable and communication cable must be connected properly. If the power cable is connected to the communication port, the main board will be burnt.

The power cable and communication cable can be identified in the following ways:

Method 1: Use sheaths in different colours.

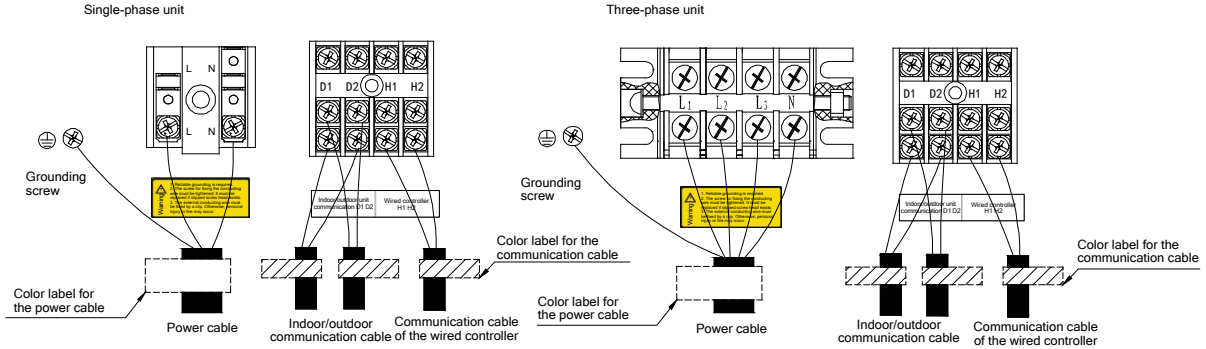

Method 2: Use different types of cables.

The diameter of the power cable is larger than that of the communication cable. Alternatively, adopt three cores or more for the power cable and two cores for the communication cable.

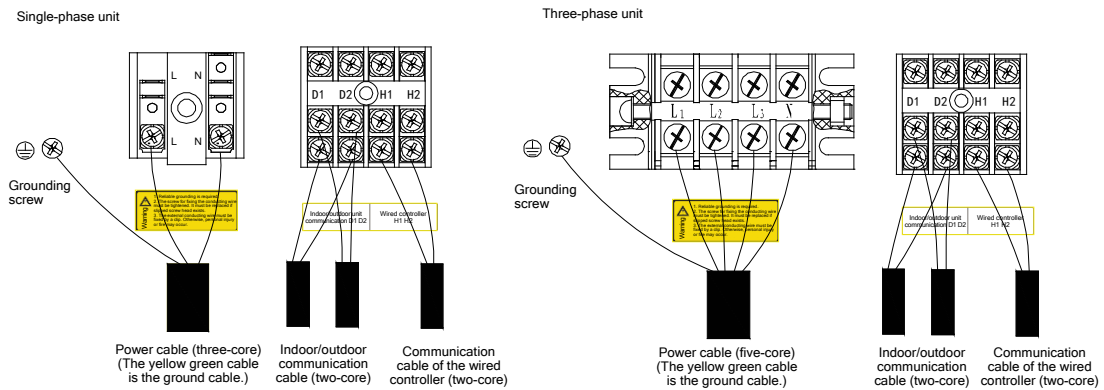

Elaborate the method with the installation personnel on site no matter which method is adopted.

# 7.2 Installation of the Power Cable

## 7.2.1 Precautions

- 1) The air conditioning unit is category 1 electrical appliance which requires reliable grounding.
- 2) The grounding resistance must meet the requirement of local law.
- 3) The yellow green cable inside the air conditioning unit is a grounding cable. It cannot be used for other purposes or be cut off. Do not fix it with tapping screws. Otherwise, an electric shock may be caused.
- 4) A reliable ground terminal must be provided for the power. Do not connect the grounding cable to any of the following:
  - a. Water pipes
  - b. Gas pipes
  - c. Drainage pipe
  - d. Other places deemed as unreliable
- 5) The power cable and the communication cable must be laid separately with a distance of greater than 20 cm. Otherwise, the communication of the unit will be affected.

## 7.2.2 Requirements on Power Cable Configuration

Every unit should be equipped with a circuit breaker for short-circuit and overload protection. In general, circuit breaker is at OFF status. During operation, all indoor units and outdoor units belonging to the same system must be kept energized status. Otherwise, the unit can't operate normally.

### 1) External Connection for Individual Units

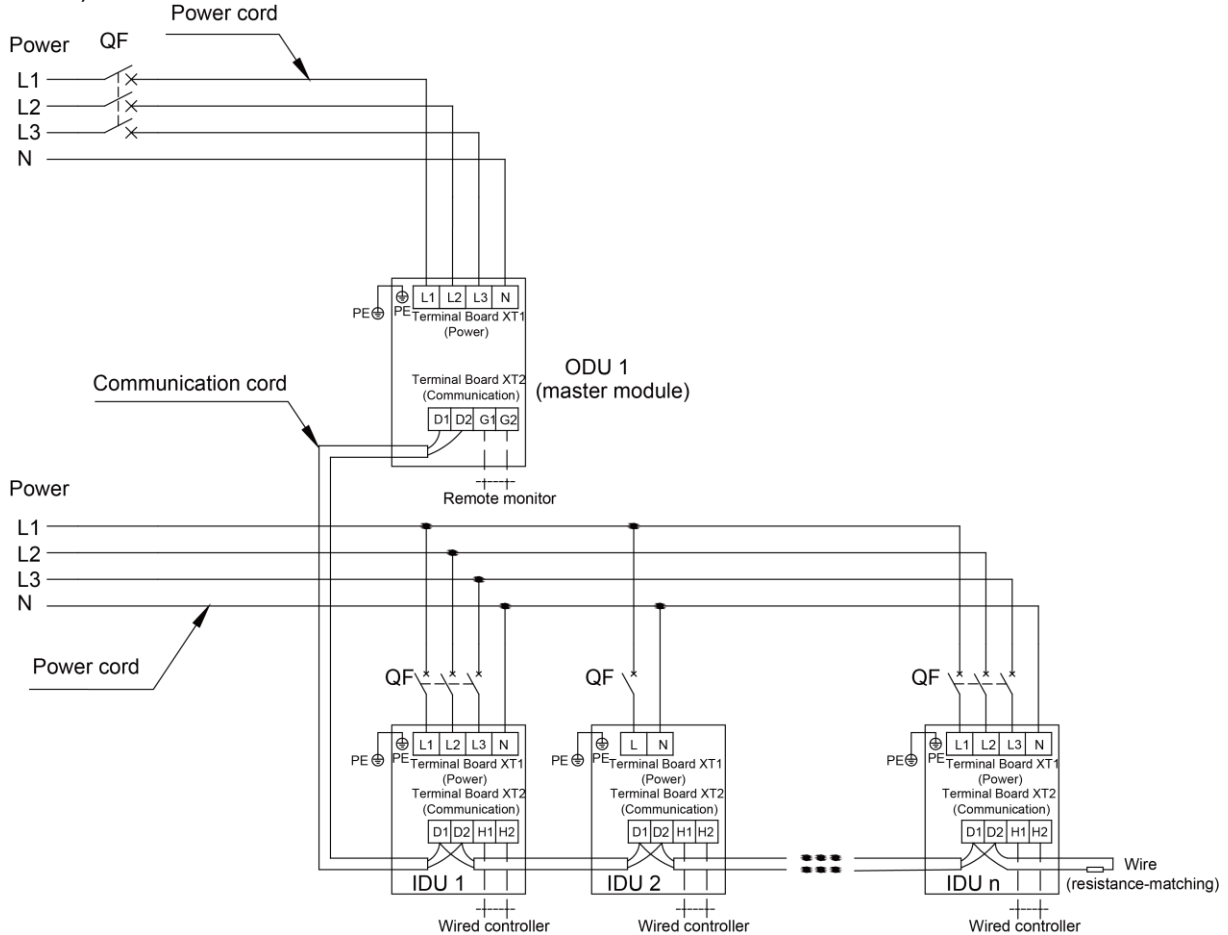

**Note:**

The maximum number of connected IDUs (n) is determined based on the capacity of the ODU. For details, see the description on unit capacity configuration.

### 2) External Connection for Modularly Connected Units

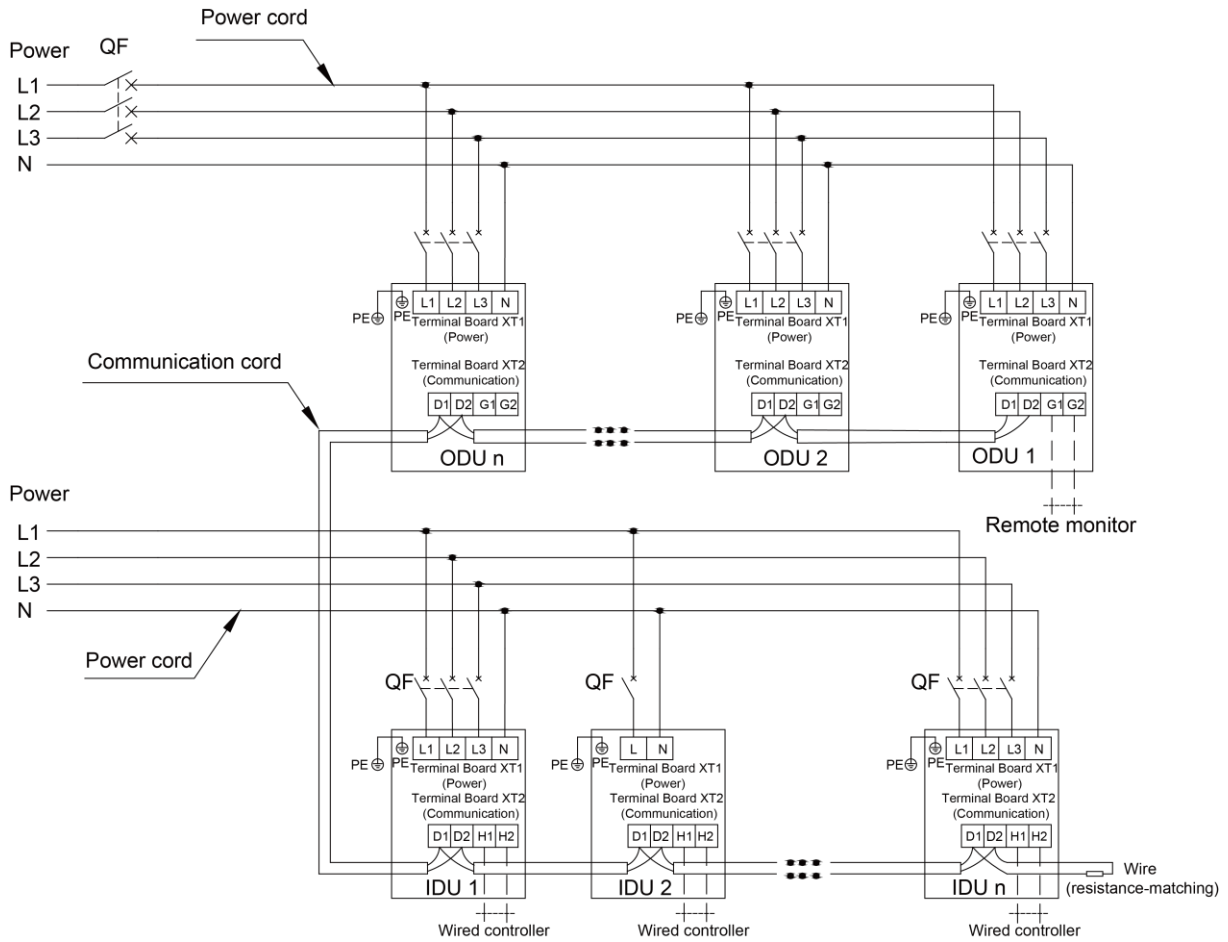

The maximum number of connected ODUs (N) and that of connected IDUs (n) are determined based on the combination form of ODUs. For details, see the description on unit capacity configuration.

### 7.2.3 Procedure for Installing the Power Cable

- 1) Knock off the knockouts used for threading the external power cable, fit the threading rubber ring to the hole, and thread the power cable through the hole. Connect L1, L2, L3, and N of the power cable, and the grounding cable to L1, L2, L3, and N on the power terminal block and the grounding screw next to the terminal block respectively.

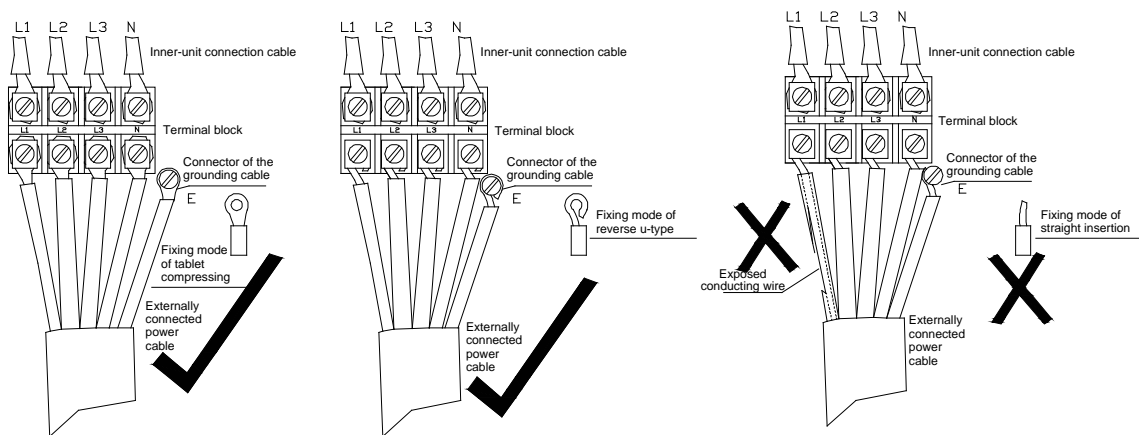

- 2) Fasten and fix the power cable with ties (support heads).
- 3) Lay the power cable and communication cable for the ODU according to the following figures.

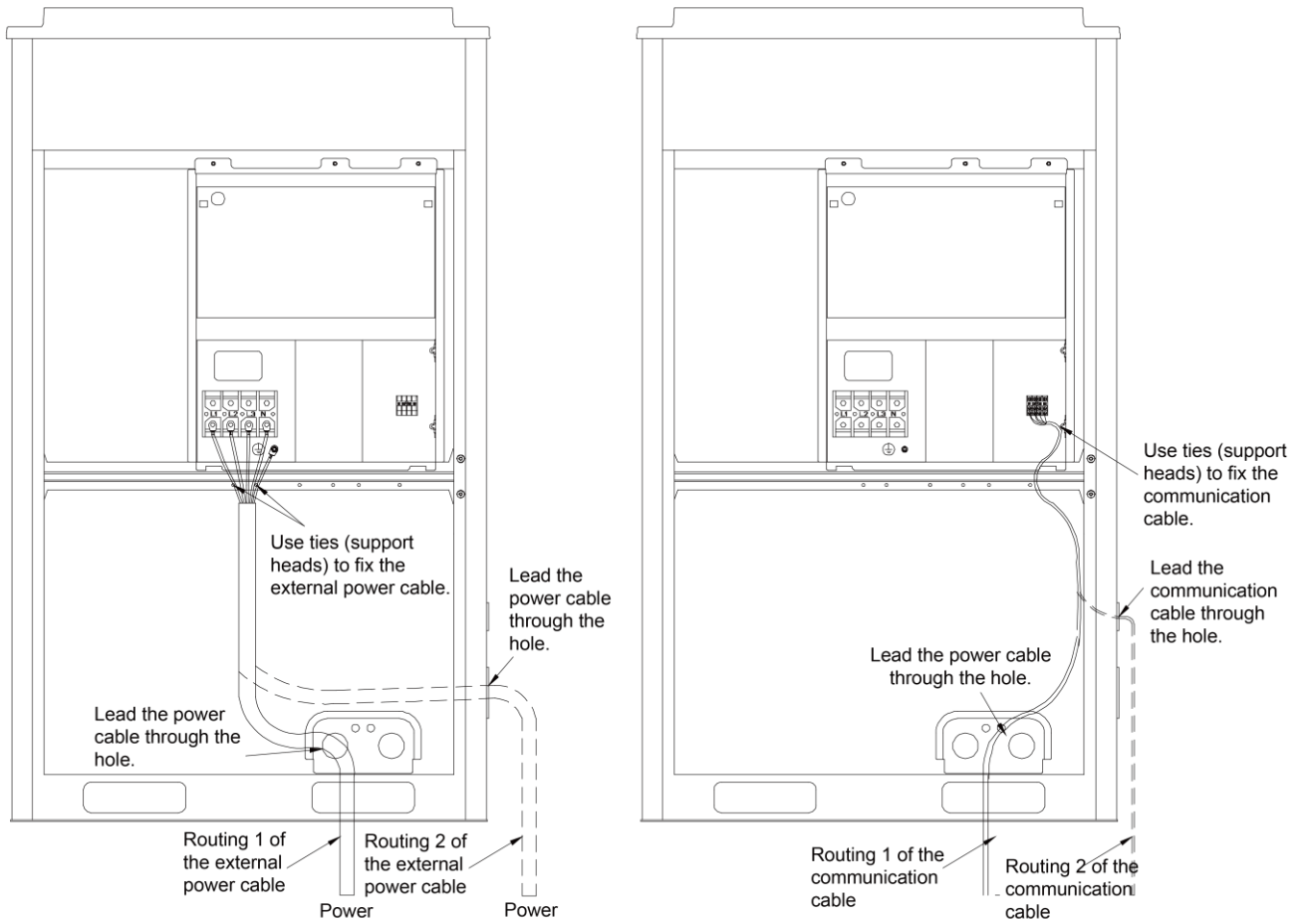

Routing diagram of the external power cable

Routing diagram of the communication cable

Note: Provide a threading rubber ring when threading a strong power cable or a communication cable.

# 7.3 Installation of the Communication System

The CAN communication network is adopted for GMV5 VRF system. Manual DIP or identification on polarities of the communication power is not required for the IDU. Only the function DIP needs to be set for the ODU. For details, see the description on function setting of the ODU.

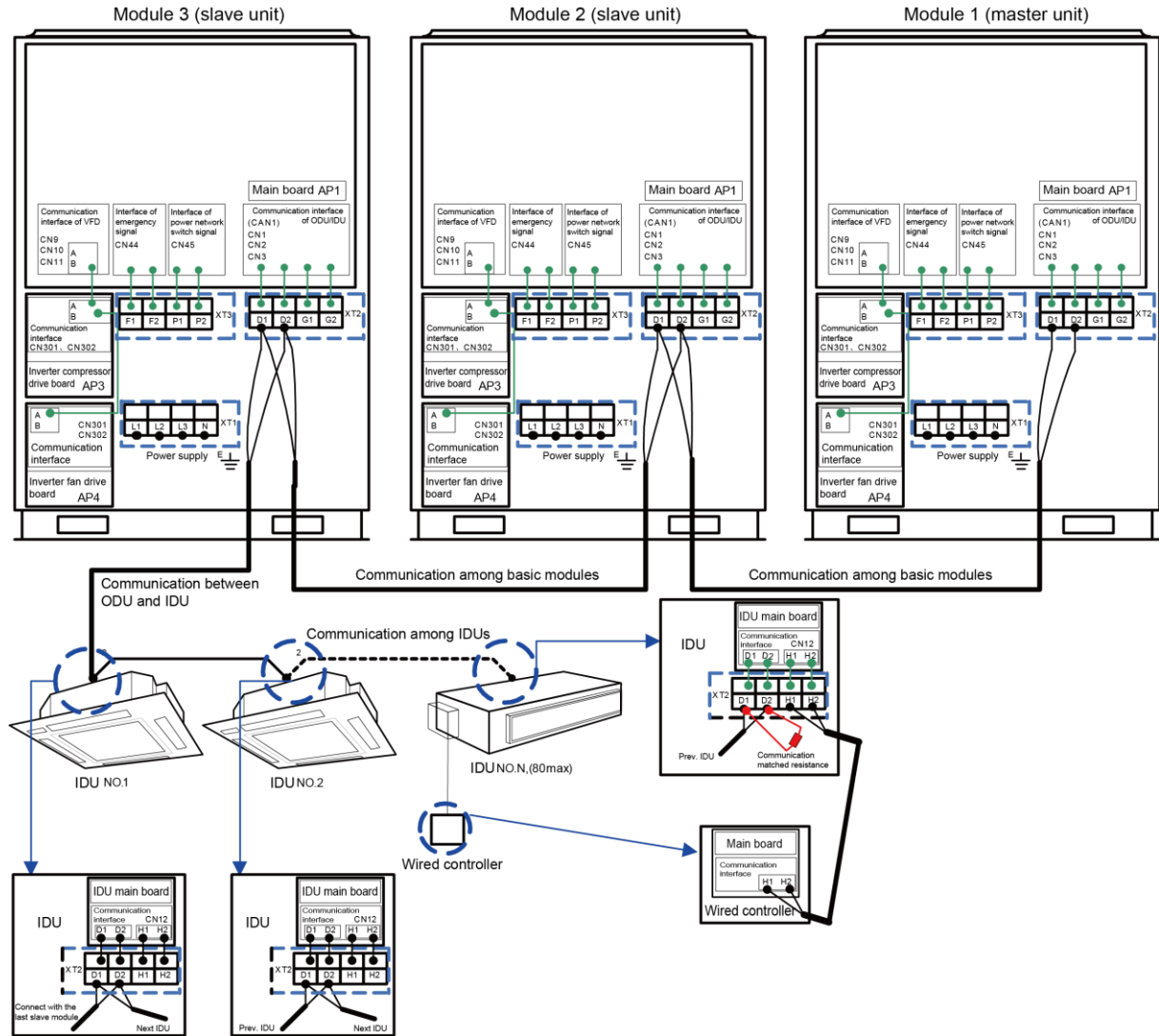

## 7.3.1 Connection of Communication Cable Terminals

All connections for communication of GMV5 are fastened by screws.

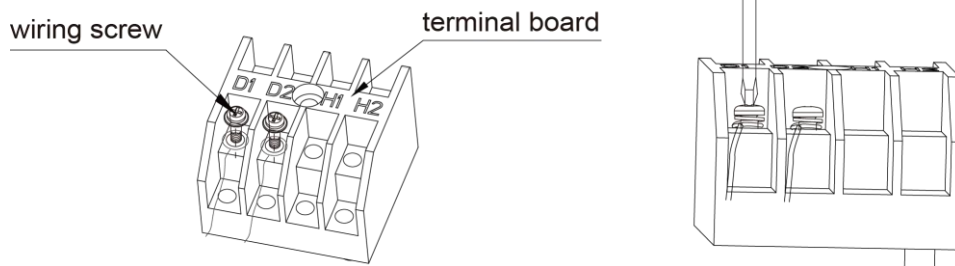

## 7.3.2 Connection of Communication Cables

The communication bus of indoor and ODUs must be connected in series instead of in star mode. The last IDU of the bus shall be connected to a matching resistor (placed in the package of the ODU).



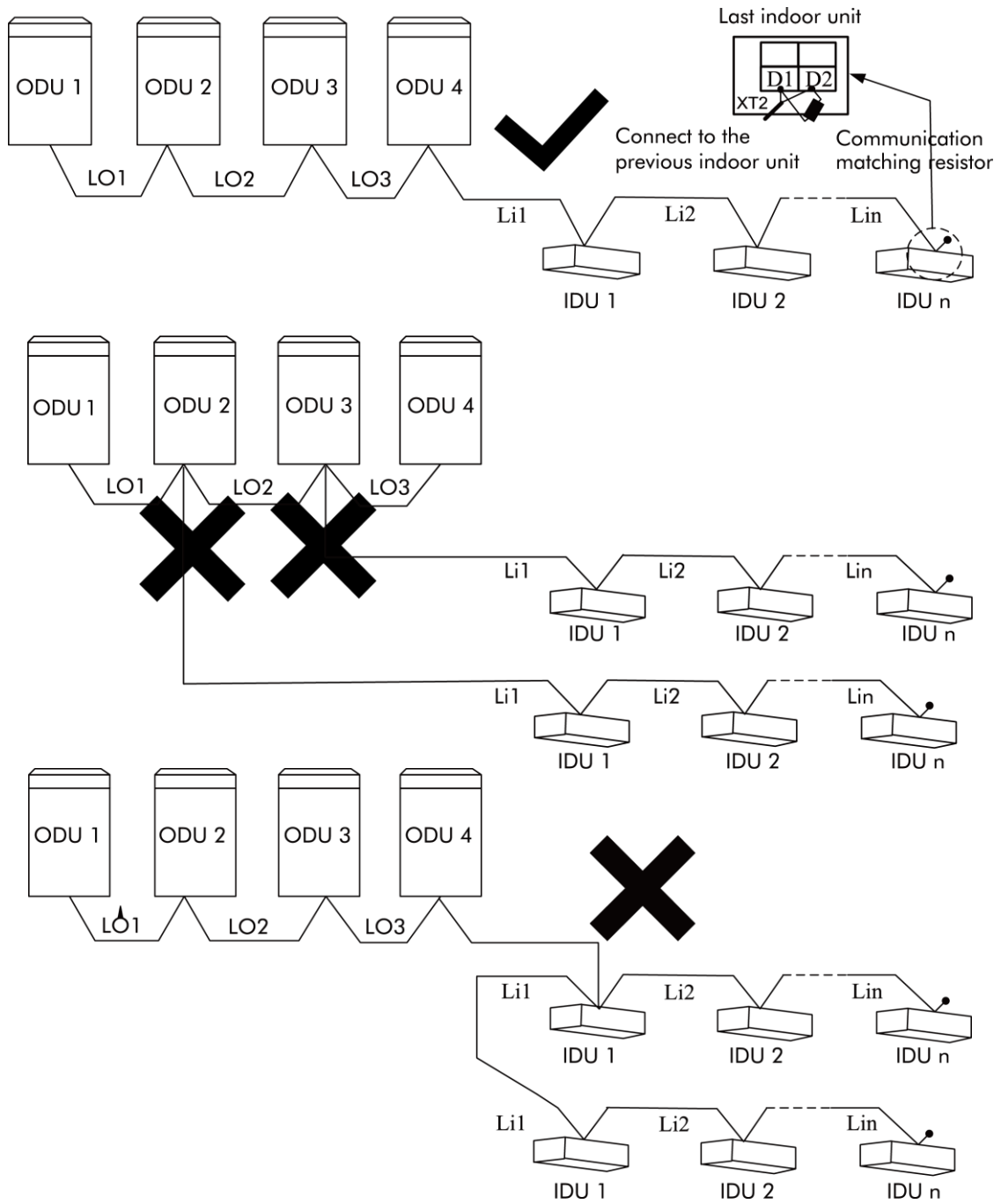

**7.3.3 Communication Cable Connection Method and Procedure**

**A. Communication cable connection between the IDUs and ODUs**

The communication cable between the IDUs and ODUs is connected via interface D1/D2 on the terminal block XT2. Connection modes for the single-module system and multi-module system are shown in the following figures.

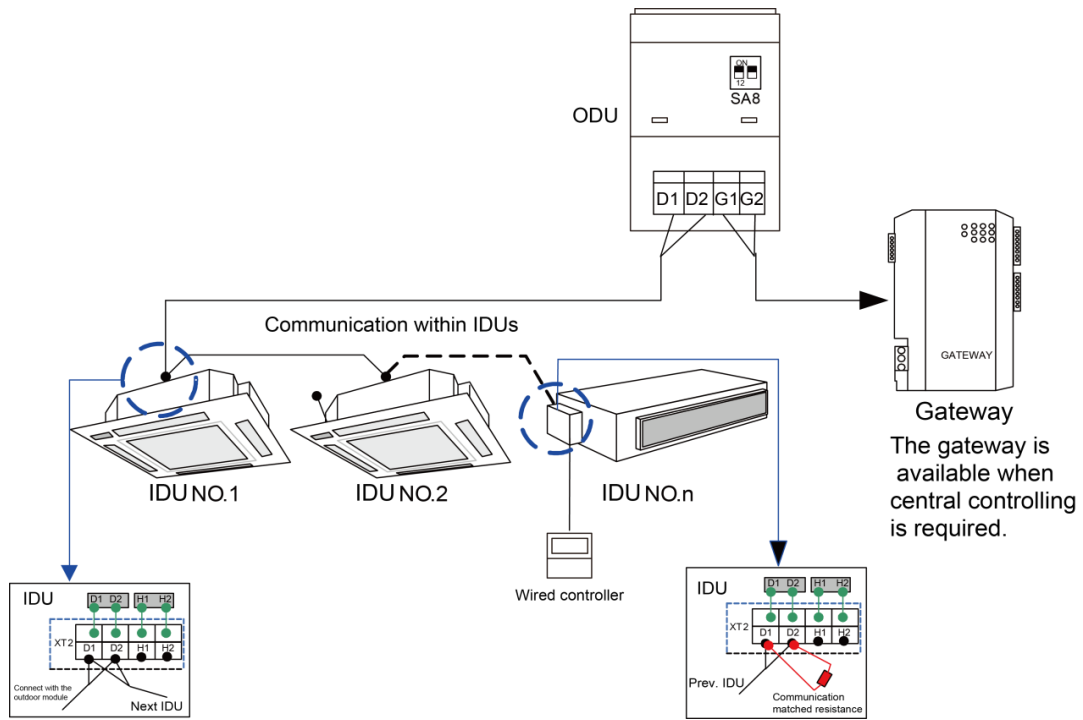

Communication cable connection for the single-module system

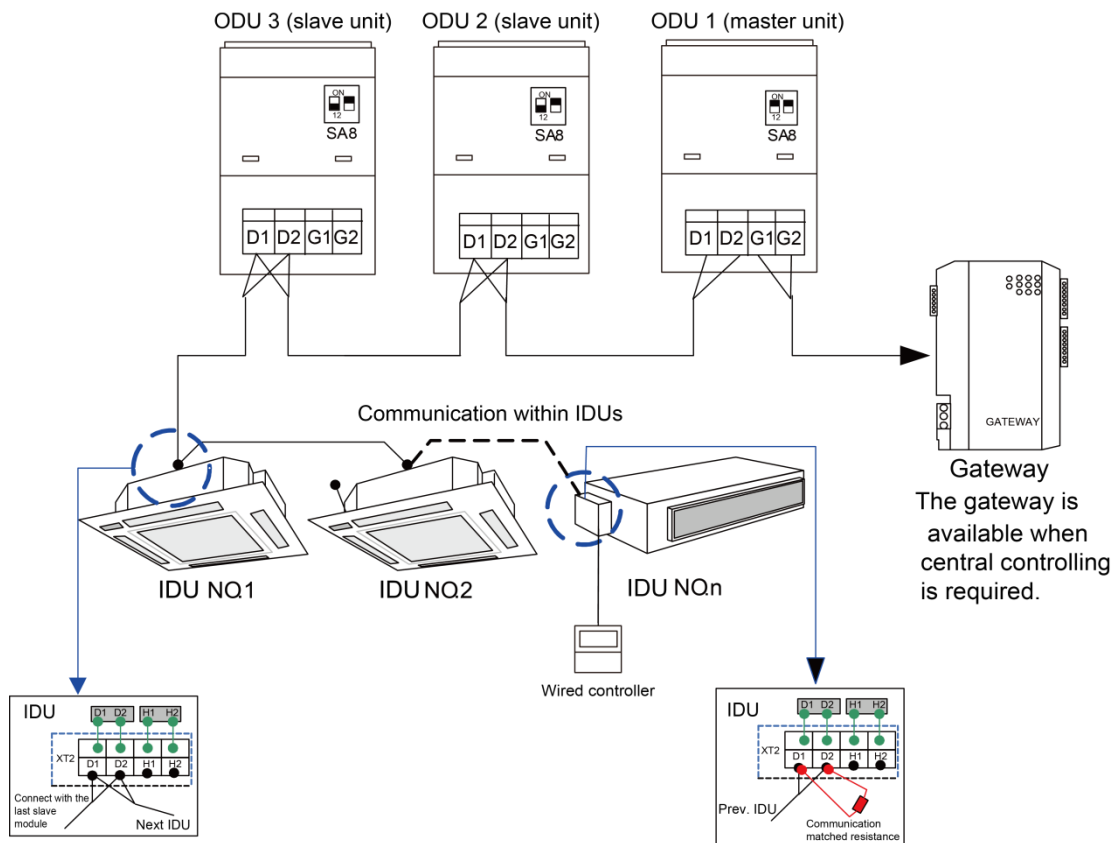

Communication cable connection for the multi-module system

Note:

- a) If there are multiple modules for the modular ODU, the master unit must be the first ODU module on the communication cable and cannot be connected to the IDU. (The master unit is set by SA8 on the main board of the ODU.)
- b) If there are multiple modules for the modular ODU, the IDU must be connected to the slave module of the last ODU. (The slave unit is set by SA8 on the main board of the ODU.)
- c) The communication cable and power cable must be laid separately to avoid interference.

- d) The communication cable must be long enough to avoid joints.
- e) Indoor units must be connected in series. The last IDU shall be connected to a matching resistor (placed in the package of the ODU).

## 8 Vacuumization and Desiccation for the Refrigerant System

Works for the refrigerant system include cleaning and desiccating the pipes, performing an air-tightness test, and perfusing refrigerant.

### 8.1 Air-tightness Test

#### 8.1.1 Importance of the Air-tightness Test

Air-tightness of the multi-module air conditioning system mainly refers to the tightness of the refrigerant pipes, which ensures secure and reliable running of the air conditioner.

Refrigerant leakage may affect functions of the air conditions or even damage the compressor and make the system to break down. Therefore, a air-tightness test must be performed. If refrigerant leakage is detected after the system is installed, it is very difficult to locate the leaking point as the suspending ceiling has been decorated. Therefore, the air-tightness test must be performed before ceiling sealing for indoor decoration is finished.

#### 8.1.2 Procedure for Performing the Air-tightness Test

Stop valves of the gas and liquid pipes of the ODU are turned off at delivery.

Before test, apply a small amount of required lubricant on the block nut and pipe terminals and use two wrenches to fix the block nut.

The ODU pipes cannot be connected when the air-tightness test is being performed.

The test pressure for R410A system is 4.0 MPa. Use dry nitrogen as media for the air-tightness test. Increase the pressure slowly by following the steps below:

Step 1: Increase the pressure to 0.5 MPa. Stop for 5 minutes and then perform air-tightness check. Major leakage may be detected.

Step 2: Increase the pressure to 1.5 MPa. Stop for 5 minutes and then perform air-tightness check. Minor leakage may be detected.

Step 3: Increase the pressure for R410A system to 4.15 MPa. Stop for 5 minutes and then perform strength check. Slight leakage or blow holes may be detected. After increasing the pressure to the test pressure, keep the pressure for 24 hours and check whether it decreases. If the pressure does not decrease, it meets the requirement.

#### 8.1.3 Precautions:

- The measuring range of the test pressure gauge for R410A system must be above 4.5 MPa.
- Record the value displayed on the pressure gauge, ambient temperature, and test time.
- Pressure correction: The pressure changes by 0.01 MPa when the temperature changes by 1°C.
- The pressure meets the requirement if it does not change.
- If the pressure must be kept for a long time, decrease the pressure to 0.5 MPa or lower. High pressure for a long time may cause leakage at the welding point or safety hazard.
- Before performing the air-tightness test to the refrigerant pipes, do not conduct insulation or wrapping at the welding or flaring opening joints of the IDU. The pressure must be increased simultaneously for pipes on outdoor sides and cannot be increased for pipes on one side.

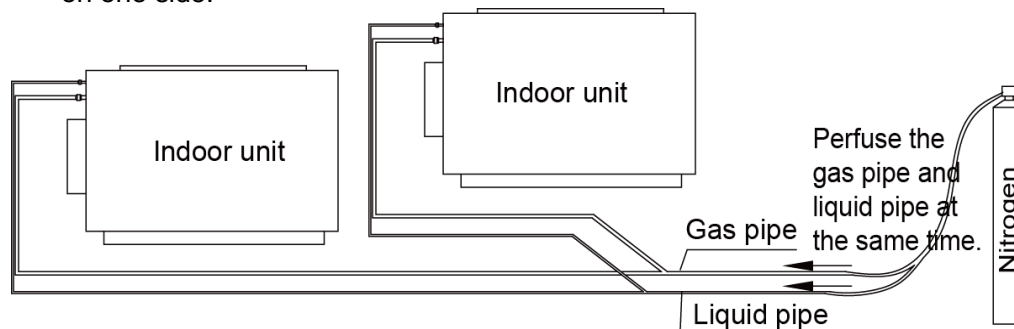

Note: Before performing the air-tightness test, do not conduct insulation or wrapping at the welding joints.

## 8.2 Vacuumization and Desiccation for the System

### 8.2.1 Requirements on the Vacuum Pump

The vacuum pump for different refrigerant systems cannot be the same.

The ultimate vacuum degree of the vacuum pump should reach  $-0.1$  MPa.

The air discharge capacity of the vacuum pump must be greater than 4 L/S.

The precision of the vacuum pump must be greater than 0.02 mmHg.

The system vacuum pump must be equipped with a check valve.

### 8.2.2 Procedure and Precautions for Vacuumization and Desiccation

#### 8.2.2.1 Procedure

- a) Before vacuumization, ensure that the stop valves of the gas and liquid pipes are turned off.
- b) Use the perfusing duct to connect the regulator valve and vacuum pump to detection connectors of the gas pipe and liquid pipe.
- c) Vacuumize for 4 hours and check whether the vacuum degree reaches  $-0.1$  MPa or more. If not, leakage may exist. Perform leakage check again. If no leakage exists, continue to vacuumize for 2 hours.
- b) If the vacuum degree cannot be kept after vacuumization is performed for twice, there may be water in the pipe when it is confirmed that no leakage exists. In this case, discharge water by means of vacuum breaking. Perfuse nitrogen at  $0.05$  MPa to the pipe. Vacuumize for 2 hours and keep vacuuming for 1 hour. If the vacuum degree of  $-0.1$  MPa cannot be reached, repeat this operation till water is discharged.
- c) After vacuumization, turn off the regulator valve and keep for 1 hour. Ensure that the pressure of the regulator valve does not increase.

#### 8.2.2.2 Precautions:

- a) The gas pipe and liquid pipe must be vacuumized at the same time.

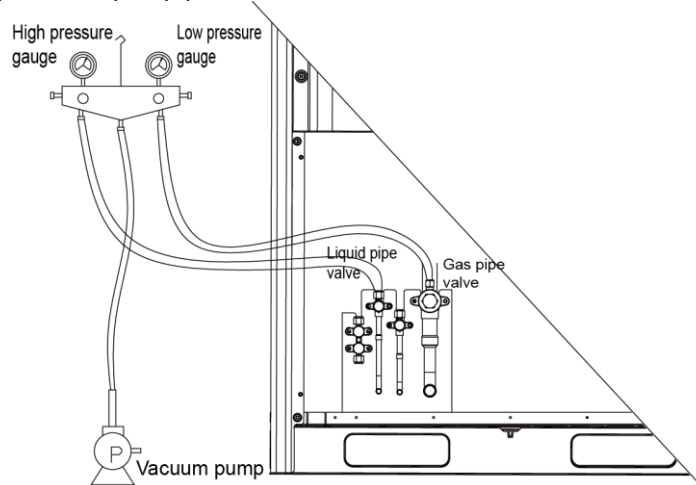

- b) Turn off the valve before powering off the vacuum pump.
- c) Keep vacuuming for 2 hours. The vacuum meets the requirement if the pressure displayed by the vacuum gauge does not increase.
- d) The units parallel connected to the module and oil-equalizing pipe also need to be vacuumized.

# 9 Refrigerant Perfusion

## 9.1 Calculation Method for Perfusing Refrigerant

Quantity of refrigerant perfused for the pipe (R) = Quantity of refrigerant perfused for the pipe (A) +  $\sum$  Quantity of refrigerant perfused for each module (B)

(1) Method for calculating the quantity of refrigerant perfused for the pipe (A):

Quantity of perfused refrigerant for the pipe (A) =  $\sum$  Length of the liquid pipe x Quantity of perfused refrigerant for the liquid pipe per meter

Diameter of the Liquid Pipe	Φ28.6	Φ25.4	Φ22.2	Φ19.05	Φ15.9	Φ12.7	Φ9.52	Φ6.35
kg/m	0.680	0.520	0.350	0.250	0.170	0.110	0.054	0.022

(2) Method for calculating  $\sum$  for the quantity of refrigerant perfused for each module (B)

Refrigerant charging amount B of every module(kg)②		Module capacity(kW)							
IDU/ODU rated capacity collocation ratio C ①	Quantity of included IDUs	22.4	28.0	33.5	40.0	45.0	50.4	56.0	61.5
50%≤C≤70%	<4	0	0	0	0	0	0	0	0
	≥4	0.5	0.5	0.5	0.5	0.5	0.5	1.0	1.5
70%<C≤90%	<4	0.5	0.5	1.0	1.5	1.5	1.5	2.0	2.0
	≥4	1.0	1.0	1.5	2.0	2.0	2.5	3.0	3.5
90%<C≤105%	<4	1.0	1.0	1.5	2.0	2.0	2.5	3.0	3.5
	≥4	2.0	2.0	3.0	3.5	3.5	4.0	4.5	5
105%<C≤135%	<4	2.0	2.0	2.5	3.0	3.0	3.5	4.0	4.0
	≥4	3.5	3.5	4.0	5.0	5.0	5.5	6.0	6.0

Note:

- ① IDU/ODU rated capacity collocation ratio C = Sum of rated cooling capacity of indoor unit / Sum of rated cooling capacity of outdoor unit
- ② If all of the indoor units are fresh air indoor units, the quantity of refrigerant added to each module is 0kg.
- ③ If outdoor air processor is connected with normal VRF indoor unit, adopt the perfusion method for normal indoor unit for perfusion.

For example1:

Outdoor unit consists of one 28kW module and one 45kW module. Five 14kW duct type units are used as indoor units.

IDU/ODU rated capacity collocation ratio C=  $14 \times 5 / (280 + 450) = 96\%$ . The quantity of included IDUs is more than 4 sets. Please refer to the above table.

Additional refrigerant quantity B for 28kW module is 2.0kg.

Additional refrigerant quantity B for 45kw module is 3.5kg.

So,  $\sum$ Refrigerant charging amount B of every module=2.0+3.5=5.5kg

Suppose the Pipeline charging amount A= $\sum$ Liquid pipe length×refrigerant charging amount of every 1m liquid pipe=20kg

Total refrigerant charging amount R=20+5.5=25.5kg

For example 2:

Outdoor unit is a 45kW module and the indoor unit is a 45kW fresh air unit. The quantity (B) of refrigerant added to this module is 0kg.

So,  $\sum$  B (Quantity of refrigerant added to each module) = 0kg

Suppose that A (Quantity of refrigerant added to connection pipe) =  $\sum$  Length of liquid pipe x Quantity of refrigerant added to liquid pipe per meter) = 5kg

R (Quantity of added refrigerant in total) = 5+0=5kg

Modular combination of outdoor unit subjects to combinations that is currently available.

## 9.2 Method for Perfusing Refrigerant

Refrigerant perfusion for the VRF system is classified into pre-perfusion and perfusion during running.

### 9.2.1 Refrigerant Pre-perfusion

Step 1: Connect the high pressure gauge pipe to the detection opening of the liquid pipe, the low pressure gauge pipe to the detection opening of the gas pipe, and the medium gauge pipe to the vacuum pump. Power on the vacuum pump to perform vacuumization and desiccation.

Step 2: After vacuumization and desiccation are finished, turn off valves of the high pressure gauge and low pressure gauge. Disconnect the medium gauge pipe from the vacuum pump and connect it to the refrigerant tank.

Step 3: Properly loosen the joint between the medium gauge pipe and the pressure gauge and slightly turn on the valve of the refrigerant tank. Vacuumize the medium gauge pipe. After that, fasten the joint and turn on the valve of the refrigerant tank completely.

Step 4: If the refrigerant tank is not equipped with a siphon, reverse the refrigerant tank and place it on the electronic scale. Then record the current weight (m1). If the refrigerant tank is equipped with a siphon, record the current weight (m1) directly.

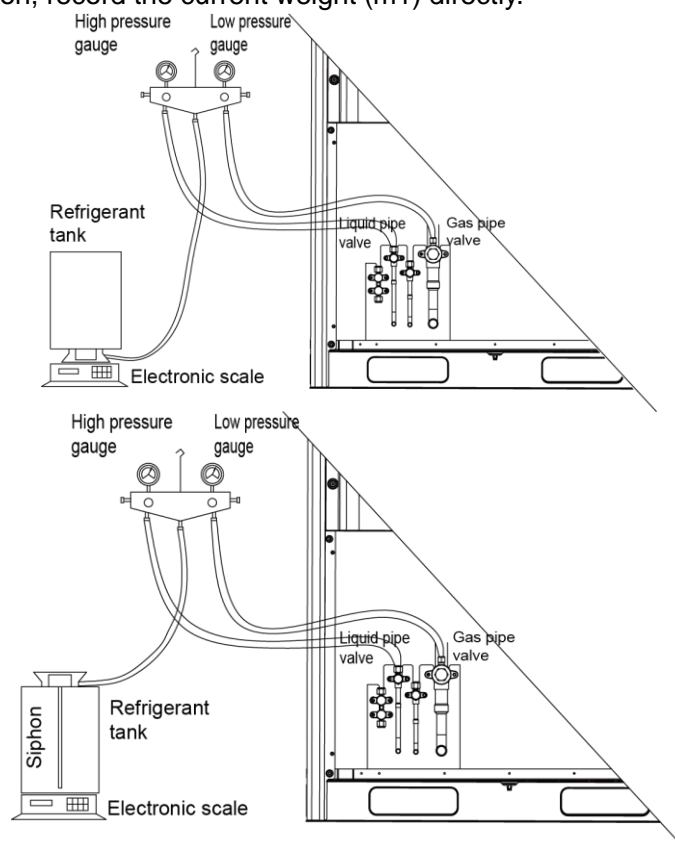

Step 5: Turn on the valve of the high pressure gauge (while keep the valve of the high pressure gauge turned off) and then perfuse refrigerant to the system. Record the change of weight of the refrigerant tank.

Step 6: When all refrigerant in the refrigerant tank is perfused, record the current weight m2.

Step 7: Turn off the valve of the high pressure gauge and replace the refrigerant tank.

Step 8: Perform step 3 again.

Step 9: Perform step 5 and step 6 again. Record the weight before perfusion m3 and weight after perfusion m4.

Step 10: If there is no sufficient refrigerant and the calculated quantity of refrigerant is not fulfilled for the system, record the current total perfusion quantity.

$$m = (m1 - m2) + (m3 - m4) + \dots + (m_{n-1} - m_n)$$

Quantity of refrigerant to be perfused during running  $m' = M - m$

M is the required total quantity

If the pre-perfusion quantity (m) reaches the required total quantity for the system, turn off the valve of the refrigerant tank immediately to finish perfusing and proceed with step 11.

Step 11: Remove the pressure gauge.

### 9.2.2 Refrigerant Perfusion During Running

Step 1: Turn off the valve of the refrigerant tank and reconnect the pressure gauge pipe. Disconnect the low pressure gauge pipe from the detection valve opening of the gas liquid and connect it to the low pressure detection valve, as shown in the following figure.

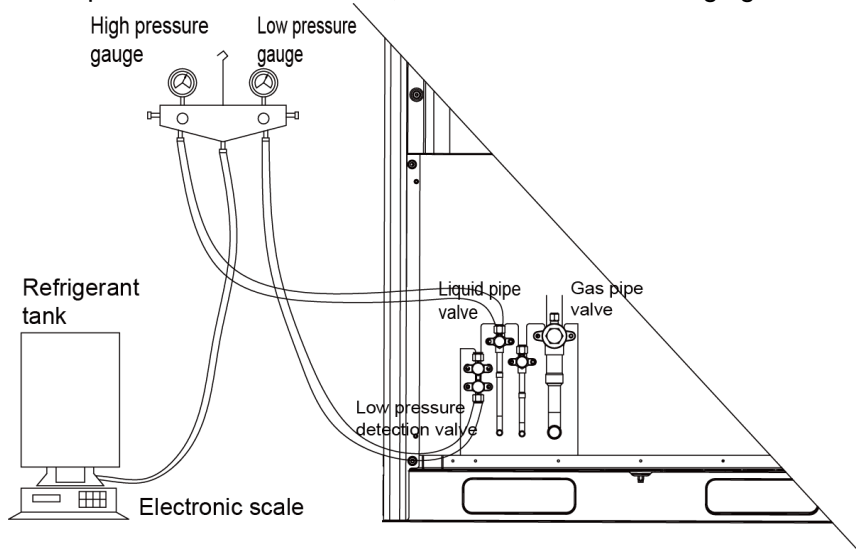

Step 2: Turn on the valves for the liquid and gas pipes of each module completely. For the modular unit, the oil-equalizing valve of each module also needs to be turned on.

Step 3: Make the system to run in commissioning mode via the commissioning software or the main board of the ODU. (For details, see the description on commissioning.)

Step 4: When the commissioning step goes to refrigerant perfusion, turn on the valve of the refrigerant tank and perfuse the remaining quantity (m<sup>3</sup>).

Step 5: After all refrigerant is perfused, turn off valve of the refrigerant tank and wait till commissioning is automatically is completed for the system.

Step 6: Remove the pressure gauge to finish refrigerant perfusion.



# Chapter 3 Commissioning Operation

## 1 Security Requirements

### 1.1 Precautions for Construction

1. All commissioning and maintenance personnel must learn and strictly comply with construction security specifications. Security measures must be taken especially for outdoor operations.

2. Workers of special types of labor, such as refrigerating engineers, electricians, and welders, must have professional certificates. No worker is allowed to do another type of labor.

3. The equipment must be powered off before relevant operations, and other security requirements should be strictly complied with.

4. All installation and maintenance operations must comply with design requirements of this product and national and local security operation requirements. Rule-breaking operations are prohibited.

### 1.2 Precautions for the Use of Refrigerants

The GMV5 serial unit is a refrigerating system of R410A working substances. Pay attention to the following points:

1. The refrigerating system of R410A working substances has a higher working pressure than that of R22 working substances. The working pressure of the former is 1.6 times than that of the latter.

2. The refrigerating system of R410A working substances uses thicker-walled copper tubes than that of R22 working substances. Adopt copper tubes with appropriate wall thickness.

3. R410A working substances are azeotropic mixture working substances. Refrigerants must be appended in the form of liquid.

# 2 Introduction to Unit Functions

Function application of ODUs consists of function DIP switch settings and function button settings, including special engineering requirements.

## 2.1 System Function DIP Switch Settings

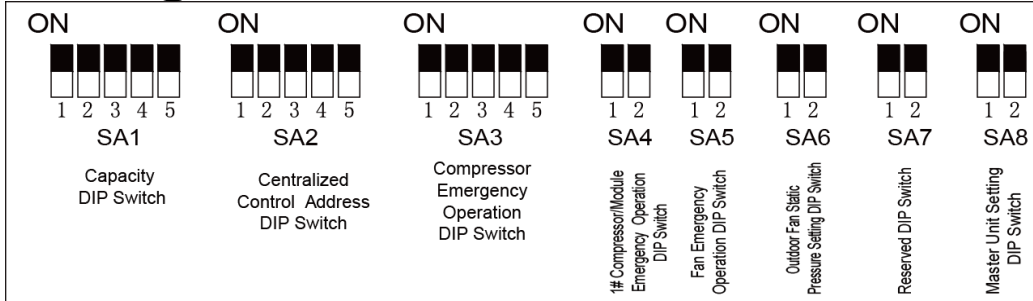

DIP Switch	Name	Meaning	Factory Settings	Remark
SA1_capacity	Capacity DIP switch	Defines the rated capacity of the unit.	Defined based on the model.	The factory settings cannot be changed.
SA2_Addr-CC	Centralized control address DIP switch	Defines and differentiates addresses of different systems in the case of centralized control by multiple systems.	00000	The address DIP switch is used only when centralized control is required. Otherwise, the factory settings are used without being changed. The address DIP switch is valid only when it is set on the master unit.
SA3_COMP-E	2#-6# compressor emergency operation DIP switch	Provides aftersales emergency settings for 2#-6# compressors.	00000	It is better not to use the emergency function. Replace the compressor at the first time when an exception occurs.
SA4_I/M-E	1# compressor/module emergency operation DIP switch	Provides aftersales emergency settings for 1# compressor/module.	00	It is better not to use the emergency function. Replace the compressor at the first time when an exception occurs.
SA5_FAN-E	Fan emergency operation DIP switch	Provides aftersales emergency settings for fans.	00	It is better not to use the emergency function. Replace relevant parts of the fan at the first time when an exception occurs.
SA6_ESP_S	Outdoor fan static pressure setting DIP switch	Sets the static pressure of the fan according to the static pressure of the exhaust pipeline connected with the engineering unit, to guarantee normal operation of the unit.	00	This DIP switch should be set based on actual engineering conditions, neither over-large nor over-small. It is unnecessary to change the factory settings in outdoor scenarios.
SA7	Reserved DIP switch	—	00	—
SA8_MASTER-S	Master unit setting DIP switch	Defines the master unit.	00	A master unit must be set, and only one master unit can be set in each refrigerating system. This DIP switch is mandatory.

				The default factory setting is the master unit status.
--	--	--	--	--

Note: On the master module, the SA8 DIP switch must be set again, the SA1 DIP switch cannot be further set, and other DIP switches retain the factory settings without special requirements.

Function DIP switches must be set when the ODU is powered off, and then the settings are valid after the ODU is powered on.

Meanings and setting methods of function DIP switches are as follows:

① Unit Capacity DIP Switch (SA1\_capacity)

The unit capacity DIP switch (SA1\_capacity) has been set upon factory departure. It is unnecessary to further set the DIP switch. In addition, users are not allowed to change the DIP switch settings. Otherwise, the system may work abnormally or even the compressor may be damaged.

② Centralized Control Address DIP Switch (SA2\_Addr-CC)

The centralized control address DIP switch (SA2\_Addr-CC) indicates the centralized control address required when different refrigerating systems are controlled in a centralized manner. The default factory setting is "00000".

If it is not required to use centralized control between multiple refrigerating systems, this DIP switch can retain the factory settings without being changed.

If it is required to use centralized control between multiple refrigerating systems, set the DIP switch according to the following methods:

- 1) The DIP switch must be set on the master unit. Otherwise, the setting is invalid.
- 2) On the same refrigerating system, the centralized control address DIP switch (SA2\_Addr-CC) on a non-master unit is invalid, and it is unnecessary to change the settings.
- 3) The centralized control address DIP switch (SA2\_Addr-CC) on the master unit of a refrigerating system must be set to "0000x", and this system is the master system.
- 4) The centralized control address DIP switch (SA2\_Addr-CC) on the master unit of other refrigerating systems must be set as follows:

SA2					Address No.
DIP1	DIP2	DIP3	DIP4	DIP5	
1	0	0	0	x	2
0	1	0	0	x	3
1	1	0	0	x	4
0	0	1	0	x	5
1	0	1	0	x	6
0	1	1	0	x	7
1	1	1	0	x	8
0	0	0	1	x	9
1	0	0	1	x	10
0	1	0	1	x	11
1	1	0	1	x	12
0	0	1	1	x	13
1	0	1	1	x	14
0	1	1	1	x	15
1	1	1	1	x	16

On the DIP switch, "ON" indicates "0" status and the opposite direction indicates "1" status. "x" indicates invalid status.

- 5) The centralized control address DIP switch (SA2\_Addr-CC) cannot be the same between different refrigerating systems. Otherwise, address conflicts may occur and the unit cannot run properly.

③ Compressor Emergency Operation DIP Switch (SA3\_COMP-E)

Corresponding to 2#-6# compressors, the compressor emergency operation DIP switch (SA3\_COMP-E) is used for aftersales emergency settings when an exception occurs on a

compressor. It can shield the operation of the abnormal compressor in a short time and guarantee the emergency operation of other compressors.

When it is required to shield the operation of 2#-6# compressors upon failure, set the DIP switch according to the following methods:

Compressor Emergency Operation DIP Switch (SA3_COMP-E)					Remark
DIP1	DIP2	DIP3	DIP4	DIP5	
0	0	0	0	0	Not shielding the operation of 2#-6# compressors
1	0	0	0	0	Shielding the operation of 2# compressor
0	1	0	0	0	Shielding the operation of 3# compressor
0	0	1	0	0	Shielding the operation of 4# compressor
0	0	0	1	0	Shielding the operation of 5# compressor
0	0	0	0	1	Shielding the operation of 6# compressor

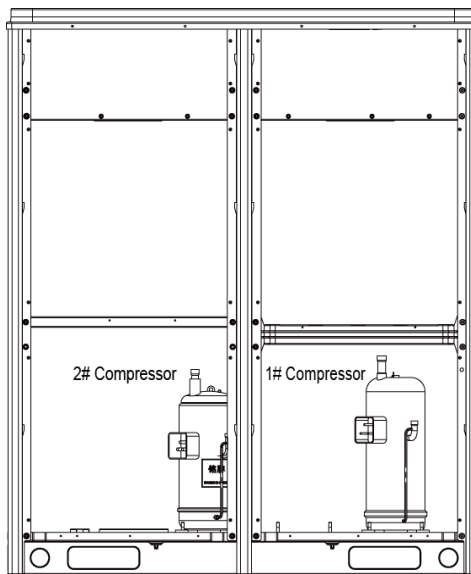

**Precautions:**

- A. When the DIP switch setting is not covered in the above scope, a DIP switch setting exception fault may occur.
- B. Only one compressor can be set to emergency mode on a module.
- C. The compressor emergency operation mode is valid only in a single-module multi-compressor system.
- D. The default factory setting is “00000”.
- E. The system cannot continually run for more than 24 hours in compressor emergency operation status. Once 24 hours are exceeded, the entire unit will be forcibly stopped and the limited operation code “Ad” is displayed on the IDU.
- F. 1#-6# compressors are defined from right to left facing the front of the unit.

④ 1# Compressor/Module Emergency Operation DIP Switch (SA4\_I/M-E)

The 1# compressor/module emergency operation DIP switch (SA4\_I/M-E) is used for aftersales emergency settings when an exception occurs on the 1# compressor/module. It can shield the operation of the abnormal compressor/module in a short time and guarantee the emergency operation of other compressors.

When it is required to set the 1# compressor/module to emergency mode, set the DIP switch as follows:

1# Compressor/Module Emergency Operation DIP Switch (SA4_I/M-E)		
DIP1	DIP2	Remark
0	0	Not shielding the operation of 1# compressor/module
1	0	Shielding the operation of 1#

		compressor
0	1	Shielding the operation of the module

Precautions:

- A. When the DIP switch setting is not covered in the above scope, a DIP switch setting exception fault may occur.
- B. Only one compressor can be set to emergency mode on a module. Subsequent to emergency operation, valves of shielded outdoor unit, including the gas pipe, liquid pipe and oil balance pipe, need to be closed tight by hand.
- C. The compressor emergency operation mode is valid only in a single-module multi-compressor system.
- D. The module emergency operation mode is valid only in a system with more than two modules connected in parallel.
- E. Only one module can be set to emergency operation mode in each system.
- F. The default factory setting is "00".
- G. The system cannot continually run for more than 24 hours in compressor emergency operation status. Once 24 hours are exceeded, the entire unit will be forcibly stopped and the limited operation code "Ad" is displayed on the IDU.
- H. The system cannot continually run for more than 48 hours in module emergency operation status. Once 48 hours are exceeded, the entire unit will be forcibly stopped and the limited operation code "Ad" is displayed on the IDU.
- I. 1#-6# compressors are defined from right to left facing the front of the unit.

⑤ Fan Emergency Operation DIP Switch (SA5\_FAN-E)

The fan emergency operation DIP switch (SA5\_FAN-E) is used for aftersales emergency settings when an exception occurs on a dual-module fan. It can shield the operation of a fan in a short time and guarantee the emergency operation of the system.

1) Fan positions

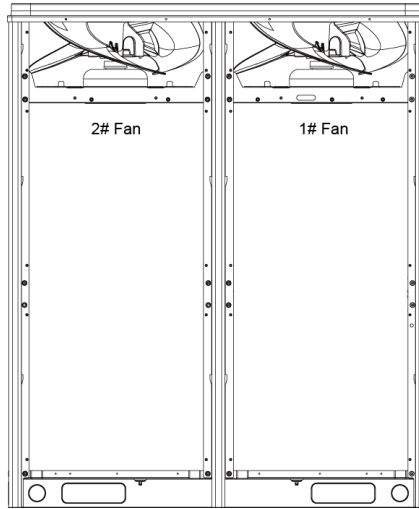

2) When it is required to set the fan to emergency mode, set the DIP switch as follows:

Fan Emergency Operation DIP Switch (SA5_FAN-E)		
DIP1	DIP2	Remark
0	0	No fan in emergency operation mode
1	0	Shielding the operation of 1# fan
0	1	Shielding the operation of 2# fan

Precautions:

- A. When the DIP switch setting is not covered in the above scope, a DIP switch setting exception fault may occur.
- B. Only one fan can be set to emergency mode on a module.
- C. The default factory setting is "00".
- D. The system cannot continually run for more than 120 hours in fan emergency operation status. Once 120 hours are exceeded, the entire unit will be forcibly stopped and the limited

operation code “Ad” is displayed on the IDU.

⑥ Outdoor Fan Static Pressure Setting DIP Switch (SA6\_ESP\_S)

The outdoor fan static pressure setting DIP switch (SA6\_ESP\_S) is used in special scenarios such as the unit installation equipment room. In scenarios where air ducts are required to be connected, zero static pressure (0 Pa), low static pressure (30 Pa), medium static pressure (50 Pa), and high static pressure (82 Pa) can be set according to the design of air ducts. The setting methods are as follows:

Outdoor Fan Static Pressure Setting DIP Switch (SA6_ESP_S)		
DIP1	DIP2	Static Pressure Range
0	0	0 Pa
1	0	30 Pa
0	1	50 Pa
1	1	82 Pa

The default factory setting is “00”.

Note that the DIP switch should be independently set on each module.

⑦ Reserved Function DIP Switch (SA7)

SA7 is the reserved function DIP switch and meaningless currently.

⑧ Master Unit Setting DIP Switch (SA8\_MASTER-S)

The master unit setting DIP switch (SA8\_MASTER-S) defines module management of a system. A master unit must be set, and only one master unit can be set in each refrigerating system (in power-off status). The setting methods are as follows:

Master Unit Setting DIP Switch (SA8_MASTER-S)		
DIP1	DIP2	Remark
0	0	Master unit
1	0	Sub-module

Upon factory departure, all modules are in “00” master unit status by default. When multiple modules are connected in parallel, only one module retains the master unit status and other modules are set to sub-module status. When a module is independently used, it uses the factory settings.

For the basic module set to master unit, the module address is displayed as “01” on the main board.

Precautions:

A. When the DIP switch setting is not covered in the above scope, a DIP switch setting exception fault may occur.

B. A module must be set to master unit status, and only one module can be set to master unit status in each refrigerating system. Other modules are set to sub-module status.

C. Settings must be performed in power-off status.

D. The default factory setting is "00" master unit status.

⑨ DIP Switch Example

A. Explanation of DIP switch positions

On the DIP switch, “ON” indicates “0” status and the opposite direction indicates “1” status.

The position of white lever indicates the position to be set to.

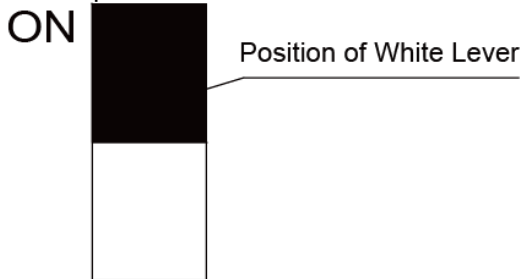

"0" Status"

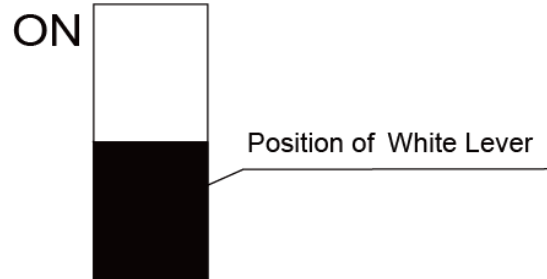

"1" Status"

B. Example

The following takes master unit settings as an example. Assume that a system consists of three modules: module a, module b, and module c. Set module c to master unit and the other two modules to sub-modules. The settings are as follows:

GMV5 DC INVERTER VRF UNITS SERVICE MANUAL

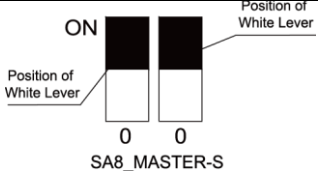
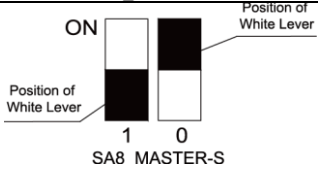
<p>Module c (Master Module)</p>	 <p>ON</p> <p>Position of White Lever</p> <p>0 0</p> <p>SA8 MASTER-S</p> <p>Position of White Lever</p>
<p>Module a/Module b (Sub-module)</p>	 <p>ON</p> <p>Position of White Lever</p> <p>1 0</p> <p>SA8 MASTER-S</p> <p>Position of White Lever</p>

## 2.2 System Function Button Operations

Note:

- ① System function settings and query must be performed after commissioning of the entire unit.
- ② System function settings and query can be used no matter whether the entire unit runs.

### 2.2.1 Introduction to Function Buttons

The main board AP1 of the ODU consists of eight function buttons:

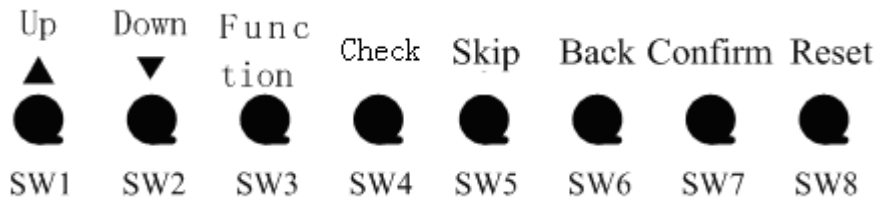

Function Button Name and Meaning		
Button	Code	Function Meaning
SW1	UP	Indicates the upward selection button.
SW2	DOWN	Indicates the downward selection button.
SW3	FUNCTION	Indicates the function button, used for function settings.
SW4	CHECK	Indicates the query button, used for function query.
SW5	SKIP	Indicates the skip button.
SW6	BACK	Indicates the return button, used to return to the upper-level menu.
SW7	CONFIRM	Indicates the confirmation button.
SW8	RESET	Indicates the reset button, used to restore factory settings.

### 2.2.2. Introduction to Functions

#### 2.2.2.1 List of functions

Function Code	Function Name	Function Meaning	Factory Settings		Remark
			Code	Meaning	
A2	Refrigerant recovery operation	Fully or partially recovers refrigerants in a faulty module or IDU pipeline according to the system pressure after automatic startup during maintenance.	—	—	It can only be set.
A6	Unit cooling/heating function	Sets the unit to cooling/heating, single-cooling, single-heating, or air supply mode for centralized management.	nA	Cooling/Heating function	It can be set and queried.
A7	Outdoor silent mode	Sets different silent modes to meet users' noise requirements.	00	No silent settings	It can be set and queried.
A8	Aftersales vacuuming mode	Automatically enables all electronic expansion valves and electromagnetic valves during maintenance to guarantee vacuum processing in all pipelines.	—	—	It can only be set.
n0	Conservation control 1	Automatically decreases the power consumption of the unit according to system operation parameters.	01	No automatic conservation settings	It can be set and queried.
n3	Forcible defrosting operation	Forcibly enables ODU defrosting operation.	—	—	It can only be set.



**GMV5 DC INVERTER VRF UNITS SERVICE MANUAL**

n4	Conservation control 2	Forcibly decreases the maximum power consumption of the unit.	00	No capacity output limitation settings	It can be set and queried.
n5	Indoor unit project number offset	Prevents IDU project number conflicts when different refrigerating systems are controlled in a centralized manner.	—	—	It can only be set.
n6	Fault query	Queries historical fault information of the ODU.	—	—	It can only be queried.
n7	Parameter query	Queries real-time operation parameters of the ODU.	—	—	It can only be queried.
n8	Indoor unit project number query	Displays project numbers of all IDUs through ODU operations.	—	—	It can only be queried.
n9	Online IDU quantity query	Displays the number of online IDUs.	—	—	It can only be queried.
nb	Outdoor unit bar code function query	Queries the entire-unit bar code and controller bar code of ODU.	—	—	It can only be queried.

**2.2.2.2 Description of Functions**

**(1) A2 Refrigerant recovery operation**

This function partially recovers refrigerants in a faulty module or IDU pipeline during unit maintenance. The refrigerant recovery volume of each basic module is as follows:

Model of Basic Module	Maximum Refrigerant Recovery Volume (kg)
GMV-224WM/B-X	7.5
GMV-280WM/B-X	7.5
GMV-335WM/B-X	8.7
GMV-400WM/B-X GMV-450WM/B-X	13.5
GMV-504WM/B-X	12.3
GMV-560WM/B-X GMV-615WM/B-X	18.4

This function falls into two modes: faulty module refrigerant recovery and IDU pipeline refrigerant recovery.

Refrigerant Recovery Mode Code	Refrigerant Recovery Mode Name	Remark
01	Indoor unit pipeline refrigerant recovery	This mode is selected when an IDU fails and it is required to recover refrigerants from the IDU pipeline.
02	Basic module refrigerant recovery	This mode is selected when a basic module fails and it is required to recover refrigerants from this basic module.

When this function is enabled, the ODU automatically starts and recovers refrigerants to the ODU or IDU pipeline.

**(2) A6 Unit cooling/heating function**

This function sets operation modes of the entire unit, including:

Function Mode of ODU		Operation Mode of IDU
Code	Name	
nA	Cooling/Heating	Cooling mode, dehumidifying mode, heating mode, and air supply mode. (Note: The heating mode cannot work with other modes at the same time.) (factory settings)
nC	Single-cooling	Cooling mode, dehumidifying mode, and air supply mode.

**GMV5 DC INVERTER VRF UNITS SERVICE MANUAL**

nH	Single-heating	Heating mode and air supply mode. (Note: The heating mode cannot work with the air supply mode at the same time.)
nF	Air supply	Air supply mode.

The user or administrator can set operation modes of the ODU based on actual situations to prevent conflicts.

When it is required to set different refrigerating systems to the same function mode, set the master system according to the above requirements. For the master system settings, see the "Centralized Control Address DIP Switch (SA2\_Addr-CC)" section.

**(3) A7 Outdoor silent mode**

This function is used when users require lower environment noises, including nighttime automatic silent mode and forcible silent mode.

For the nighttime automatic silent mode, the system automatically judges the highest daytime environment temperature and then starts silent operations in a certain interval to guarantee nighttime low-noise operations. The nighttime automatic silent mode falls into nine categories:

Silent Mode	Code	Starting the Silent Mode X Hours after the Daytime Temperature Reaches the Highest	Stopping the Nighttime Silent Mode after Continual Operations for Y Hours	Noise Degree
Mode 1	01	6	10	Low-noise mode
Mode 2	02	6	12	
Mode 3	03	8	8	
Mode 4	04	8	10	
Mode 5	05	10	8	
Mode 6	06	10	10	
Mode 7	07	4	14	
Mode 8	08	6	8	Low- and medium-noise mode
Mode 9	09	12	10	superlow-noise mode

Note: The highest daytime temperature is generally in 13:00-15:00.

For the forcible silent mode, the system runs in low-noise mode no matter in the daytime or nighttime. The forcible silent mode falls in three categories:

Silent Mode	Code	Noise Degree
Mode 10	10	Low-noise mode
Mode 11	11	Low- and medium-noise mode
Mode 12	12	superlow-noise mode

Note: The system capacity may fall off after the silent mode is set. Therefore, try to balance the noise with the capacity in selecting a silent mode category.

The factory setting is "00".

**(4) A8 Aftersales vacuuming mode**

This function ensures the vacuum degree of the entire system during maintenance to prevent operation functions of dead zones. Expansion valves and electromagnetic valves of the unit will be enabled after this function is set.

**(5) n0 Conservation control 1**

System conservation is set when conservation operations are required. The default factory setting is capacity priority control mode. The system capacity may fall off after the conservation mode is set.

Code	Function Name
01	Conservation control – invalid (factory settings)
02	Conservation control - valid

**(6) n3 Forcible defrosting operation**

This function is set when forcible defrosting is required for the unit during maintenance. After this function is enabled, the system automatically quits based on quitting conditions and then automatically runs based on system conditions.

(7) n4 Conservation control 2

The highest capacity output limitation is set when users require forcibly limiting the system power consumption. The setting scope is as follows:

Code	Highest Output Capacity
10	100% (factory settings)
09	90%
08	80%

Note: The cooling or heating effect may fall off after the capacity limitation is set.

(8) n5 Indoor unit project number offset

This function sets the IDU project number when multiple refrigerating systems are controlled in a centralized manner (by using a remote monitor or centralized controller), avoiding the same project number between different systems. If the project number is not set, project number conflicts may occur between systems.

This function only needs to be set on the master system, which is the system with the centralized control address SA2 DIP switch being "00000". For details, see the "Centralized Control Address DIP Switch (SA2\_Addr-CC)" section.

(9) n6 Fault query

This function queries historical faults of the system. Up to five historical faults can be memorized in time order.

(10) n7 Parameter query

This function queries operation parameters of each module of the ODU in real time.

(11) n8 Indoor unit address query

This function queries addresses of all IDUs through one operation of the ODU.

(12) n9 Online IDU quantity query

This function queries the number of online IDUs through the ODU.

**2.2.3 Function Setting Operations**

Step 1: Open the commissioning window of the master unit panel.

Step 2: Power on the entire unit.

Step 3: Press "SW3" on the master unit to enter the to-be-selected status of function settings.

By default, the master unit is displayed as follows:

LED1		LED2		LED3	
Function Code	Display Mode	Current Progress	Display Mode	Current Status	Display Mode
A7	Blinking	00	Blinking	00	Blinking

Users can select corresponding functions by pressing "SW1 (UP)" or "SW2 (DOWN)" on the master unit, including:

LED1		LED2		LED3	
Function Code	Display Mode	Current Progress	Display Mode	Current Status	Display Mode
A7	Blinking	00	Blinking	00	Blinking
A6	Blinking	00	Blinking	00	Blinking
A2	Blinking	00	Blinking	00	Blinking
A8	Blinking	00	Blinking	00	Blinking
n0	Blinking	01	Blinking	00	Blinking
n3	Blinking	00	Blinking	00	Blinking
n4	Blinking	00	Blinking	00	Blinking
n5	Blinking	00	Blinking	00	Blinking

After selecting the functions to be set, press "SW7" to confirm entering function settings. The master unit is displayed as follows:

LED1		LED2		LED3	
Function Code	Display Mode	Current Progress	Display Mode	Current Status	Display Mode
A7	On	00	Blinking	OC	Blinking
A6	On	nC	Blinking	nC	Blinking

GMV5 DC INVERTER VRF UNITS SERVICE MANUAL

A2	On	01	Blinking	00	Blinking
A8	On	00	Blinking	OC	Blinking
n0	On	01	Blinking	OC	Blinking
n3	On	00	Blinking	00	Blinking
n4	On	10	Blinking	OC	Blinking
n5	On	00	Blinking	OC	Blinking

Then go to step 4 to set corresponding functions.

Step 4: Set function parameters.

Setting methods of function parameters are as follows:

① A7 Outdoor silent mode settings

Step 1: Confirm entering the A7 outdoor silent mode settings. The master unit is displayed as follows:

LED1		LED2		LED3	
Function Code	Display Mode	Silent Mode Code	Display Mode	Current Status	Display Mode
A7	On	00	Blinking	OC	Blinking

Step 2: Select a corresponding silent mode by pressing "SW1 (UP)" or "SW2 (DOWN)".

LED1		LED2		LED3	
Function Code	Display Mode	Silent Mode Code	Display Mode	Current Status	Display Mode
A7	On	00	Blinking	OC	Blinking
A7	On	01	Blinking	OC	Blinking
A7	On	02	Blinking	OC	Blinking
A7	On	03	Blinking	OC	Blinking
A7	On	04	Blinking	OC	Blinking
A7	On	05	Blinking	OC	Blinking
A7	On	06	Blinking	OC	Blinking
A7	On	07	Blinking	OC	Blinking
A7	On	08	Blinking	OC	Blinking
A7	On	09	Blinking	OC	Blinking
A7	On	10	Blinking	OC	Blinking
A7	On	11	Blinking	OC	Blinking
A7	On	12	Blinking	OC	Blinking

Step 3: Press "SW7" to confirm selecting the mode. The master unit is displayed as follows:

LED1		LED2		LED3	
Function Code	Display Mode	Silent Mode Code	Display Mode	Current Status	Display Mode
A7	On	00	On	OC	On
A7	On	01	On	OC	On
A7	On	02	On	OC	On
A7	On	03	On	OC	On
A7	On	04	On	OC	On
A7	On	05	On	OC	On
A7	On	06	On	OC	On
A7	On	07	On	OC	On
A7	On	08	On	OC	On
A7	On	09	On	OC	On

GMV5 DC INVERTER VRF UNITS SERVICE MANUAL

A7	On	10	On	OC	On
A7	On	11	On	OC	On
A7	On	12	On	OC	On

On the master unit, press "SW6" to return to the upper level (press "SW6" in setting status to return to the upper level; press "SW6" after settings are completed to restore the normal operating status of the unit).

If no button operations are performed on the master unit for five minutes, the function setting automatically quits and the unit restores the current status.

The default factory setting is "00", that is, no silent mode.

② A6 Unit cooling/heating function settings

Step 1: Confirm entering the A6 unit cooling/heating function settings. The master unit is displayed as follows:

LED1		LED2		LED3	
Function Code	Display Mode	ODU Function Mode Code	Display Mode	ODU Function Mode Code	Display Mode
A6	On	nC	Blinking	nC	Blinking

Step 2: Select a corresponding cooling/heating function by pressing "SW1 (UP)" or "SW2 (DOWN)".

LED1		LED2		LED3	
Function Code	Display Mode	ODU Function Mode Code	Display Mode	ODU Function Mode Code	Display Mode
A6	On	nC	Blinking	nC	Blinking
A6	On	nH	Blinking	nH	Blinking
A6	On	nA	Blinking	nA	Blinking
A6	On	nF	Blinking	nF	Blinking

Step 3: Press "SW7" to confirm selecting the mode. The master unit is displayed as follows:

LED1		LED2		LED3	
Function Code	Display Mode	ODU Function Mode Code	Display Mode	ODU Function Mode Code	Display Mode
A6	On	nC	On	nC	On
A6	On	nH	On	nH	On
A6	On	nA	On	nA	On
A6	On	nF	On	nF	On

On the master unit, press "SW6" to return to the upper level (press "SW6" in setting status to return to the upper level; press "SW6" after settings are completed to restore the normal operating status of the unit).

If no button operations are performed on the master unit for five minutes, the function setting automatically quits and the unit restores the current status.

The default factory setting is "nA" cooling/heating.

③ A2 Refrigerant recovery operation settings

Step 1: Confirm entering the A2 refrigerant recovery operation settings. The master unit is displayed as follows:

LED1		LED2		LED3	
Function Code	Display Mode	Refrigerant Recovery Code	Display Mode	Current Status	Display Mode
A2	On	01	Blinking	00	Blinking

Step 2: The default setting is "01". Select "01" or "02" by pressing "SW1 (UP)" or "SW2 (DOWN)". Press "SW7" to confirm selecting the mode.

On the master unit, press "SW6" to return to the upper level.

If no button operations are performed on the master unit for five minutes, the function setting automatically quits and the unit restores the current status.

✧ **Indoor unit refrigerant recovery**

Step 3: Select "01" as in step 2 to enter IDU refrigerant recovery. Digital LEDs and status LEDs of all basic modules are displayed as follows:

LED1		LED2		LED3	
Function Code	Display Mode	Refrigerant Recovery Code	Display Mode	Current Status	Display Mode
A2	On	01	On	[Module low-pressure Ps]	On

LED3 shows the low-pressure value of a module. If the value is negative, LED3 circularly displays the negative code "nE" and the numeric value every one second. For example, for -30°C, LED3 alternately displays "nE" for one second and then "30" for another second.

Step 4: Close liquid-tube stop valves of all basic modules of the ODU. When the low-pressure value displayed on LED3 continually blinks, quickly close air-tube stop valves of all basic modules and then press "SW7" on the master unit to confirm completing refrigerant recovery or power off the entire unit.

If no operations are performed after the low-pressure value displayed on LED3 continually blinks for three minutes, the entire unit will be forcibly stopped.

On the master unit, press "SW6" to return to the upper level for restoring the standby status of the entire unit (press "SW6" in setting status to return to the upper level; press "SW6" after settings are completed to restore the normal operating status of the unit).

Note:

Another startup is not allowed within 10 minutes after refrigerant recovery.

✧ **Basic module refrigerant recovery**

Step 3: Set the basic module requiring refrigerant recovery to module emergency operation status and close the liquid-tube stop valve of the emergency status module. Select "02" as in step 2 to enter basic module refrigerant recovery. The display is as follows:

LED1		LED2		LED3	
Function Code	Display Mode	Current Progress	Display Mode	Current Status	Display Mode
A2	On	02	On	Module high-pressure	On

LED3 shows the high-pressure value of the module.

Step 4: When the high-pressure value displayed on LED3 continually blinks (displayed as 0°C if the high pressure is less than 0°C), quickly close the air-tube stop valve of the emergency module and then press "SW7" on the master unit to confirm completing refrigerant recovery or power off the entire unit.

If no operations are performed after the high-pressure value displayed on LED3 continually blinks for three minutes, the entire unit will be forcibly stopped.

On the master unit, press "SW6" to return to the upper level for restoring the standby status of the entire unit (press "SW6" in setting status to return to the upper level; press "SW6" after settings are completed to restore the normal operating status of the unit).

Note:

Before the basic module refrigerant recovery operation, users must close the liquid-tube stop valve of the basic module requiring refrigerant recovery.

Another startup is not allowed within 10 minutes after refrigerant recovery.

④ **A8 Aftersales vacuuming mode settings**

Step 1: Confirm entering the A8 aftersales vacuuming mode settings. The master unit is displayed as follows:

LED1		LED2		LED3	
Function Code	Display Mode	Current Progress	Display Mode	Current Status	Display Mode
A8	On	00	Blinking	OC	Blinking

Enter the to-be-confirmed status of system vacuuming mode settings.

Step 2: Press "SW7" to confirm entering the to-be-confirmed status of system vacuuming mode settings. All modules are displayed as follows:

LED1		LED2		LED3	
Function Code	Display Mode	Current Progress	Display Mode	Current Status	Display Mode

A8	On	00	On	OC	On
----	----	----	----	----	----

Expansion valves and electromagnetic valves of all outdoor and IDUs are opened, and the entire unit cannot be enabled.

Press "SW6" on the master unit to quit the vacuuming status. Alternatively, the entire unit quits the vacuuming status after 24 hours.

⑤ n0 System conservation operation settings

Step 1: Confirm entering the n0 system conservation operation settings. The master unit is displayed as follows:

LED1		LED2		LED3	
Function Code	Display Mode	Code	Display Mode	Current Status	Display Mode
n0	On	01	Blinking	OC	Blinking

Step 2: Select a corresponding mode by pressing "SW1 (UP)" or "SW2 (DOWN)".

LED1		LED2		LED3	
Function Code	Display Mode	Code	Display Mode	Current Status	Display Mode
n0	On	01	Blinking	OC	Blinking
n0	On	02	Blinking	OC	Blinking

Step 3: Press "SW7" to confirm selecting the mode. The master unit is displayed as follows:

LED1		LED2		LED3	
Function Code	Display Mode	Code	Display Mode	Current Status	Display Mode
n0	On	01	On	OC	On
n0	On	02	On	OC	On

If no button operations are performed for five minutes, the function setting automatically quits and the unit restores the current status. (Press "SW6" in setting status to return to the upper level; press "SW6" after settings are completed to restore the normal operating status of the unit.)

⑥ n3 Forcible defrosting operation settings

Step 1: Confirm entering the n3 forcible defrosting operation settings. The master unit is displayed as follows:

LED1		LED2		LED3	
Function Code	Display Mode	Current Progress/Mode	Display Mode	Current Status	Display Mode
n3	On	00	Blinking	00	Blinking

Step 2: Press "SW7" to confirm entering forcible defrosting. The master module is displayed as follows:

LED1		LED2		LED3	
Function Code	Display Mode	Current Progress/Mode	Display Mode	Current Status	Display Mode
n3	On	00	On	00	On

When the unit reaches defrosting quit conditions, the system automatically quits and restores the normal operation control.

⑦ n4 Highest capacity output limitation settings

Step 1: Confirm entering the n4 highest capacity output limitation settings. The master unit is displayed as follows:

GMV5 DC INVERTER VRF UNITS SERVICE MANUAL

LED1		LED2		LED3	
Function Code	Display Mode	Highest Output Capacity	Display Mode	Current Status	Display Mode
n4	On	10	Blinking	OC	Blinking

Step 2: Select a corresponding capacity limitation value by pressing "SW1 (UP)" or "SW2 (DOWN)".

LED1		LED2		LED3	
Function Code	Display Mode	Highest Output Capacity	Display Mode	Current Status	Display Mode
n4	On	10	Blinking	OC	Blinking
n4	On	09	Blinking	OC	Blinking
n4	On	08	Blinking	OC	Blinking

Step 3: Press "SW7" to confirm selecting the mode. The master module is displayed as follows:

LED1		LED2		LED3	
Function Code	Display Mode	Highest Output Capacity	Display Mode	Current Status	Display Mode
n4	On	10	On	OC	On
n4	On	09	On	OC	On
n4	On	08	On	OC	On

If no button operations are performed on the master unit for five minutes, the function setting automatically quits and the unit restores the current status. (Press "SW6" in setting status to return to the upper level; press "SW6" after settings are completed to restore the normal operating status of the unit.)

⑧ n5 Indoor unit project number offset settings

Step 1: Confirm entering the n5 IDU project number offset settings. The master unit is displayed as follows:

LED1		LED2		LED3	
Function Code	Display Mode	Current Progress/Mode	Display Mode	Current Status	Display Mode
n5	On	00	Blinking	00	Blinking

Step 2: Press "SW7" to send the project number offset command. The master module is displayed as follows:

LED1		LED2		LED3	
Function Code	Display Mode	Current Progress/Mode	Display Mode	Current Status	Display Mode
n5	On	00	On	OC	On

After 10 seconds, the system quits this mode and restores the normal operation mode.

Note: This function only needs to be set on the master system, which is the system with the centralized control address SA2 DIP switch being "00000". For details, see the "Centralized Control Address DIP Switch (SA2\_Addr-CC)" section.



**2.2.4 Function Query Operations**

Step 1: Open the commissioning window of the master unit panel.

Step 2: Power on the entire unit.

Step 3: Press "SW4" on the master unit to enter the query status.

Step 4: Select a function to be queried by pressing "SW1 (UP)" or "SW2 (DOWN)" on the master unit. By default, the A7 outdoor silent mode is displayed for query.

For example, select the A6 unit cooling/heating function. The display is as follows:

LED1		LED2		LED3	
Function Code	Display Mode	ODU Function Mode Code	Display Mode	ODU Function Mode Code	Display Mode
A6	On	nA	On	nA	On

Step 5: If the n8 IDU address query is selected, the display is as follows. Enter the to-be-confirmed status of IDU project number query.

LED1		LED2		LED3	
Function Code	Display Mode	Current Progress/Mode	Display Mode	Current Status	Display Mode
n8	Blinking	00	Blinking	00	Blinking

Press "SW7" and select the IDU project number query on the master unit. The master unit is displayed as follows. Other modules are displayed in normal status.

LED1		LED2		LED3	
Function Code	Display Mode	Current Progress/Mode	Display Mode	Current Status	Display Mode
n8	On	00	On	00	On

Regardless of the current display status of wired controllers or display panels of all IDUs, the current display status is all switched to the IDU project number. However, it does not influence the settings and operation status of outdoor and IDUs.

On the master unit, press "SW6" to return to the upper level. The IDU retains the project number display status.

On the master unit, press and hold "SW6" to quit the address display status for all IDUs and return to the upper level.

If no quit button operations are performed on the master unit for 30 minutes, the function setting automatically quits and the unit restores the current status.

Step 6: If the n9 IDU address query is selected, the display is as follows:

LED1		LED2		LED3	
Function Code	Display Mode	Number of IDUs (Thousands-place Hundreds-place)	Display Mode	Number of IDUs (Tens-place Ones-place)	Display Mode
n9	On	00	On	00	Blinking

The digital LED2 displays the number of IDUs (thousands-place hundreds-place) and the digital LED3 displays the number of IDUs (tens-place ones place). For example, if the number of IDUs is 75, "0075" is displayed.

If no button operations are performed on the master unit for five minutes, the function setting automatically quits and the unit restores the current status.

Note: The online IDU quantity query function applies to a single refrigerating system only.

Step 7: If the n6 fault query is selected, the display is as follows. Enter the to-be-confirmed status of fault query.

LED1		LED2		LED3	
Function Code	Display Mode	Current Progress/Mode	Display Mode	Current Status	Display Mode
n6	Blinking	00	Blinking	00	Blinking

Press "SW7" on the master unit to confirm fault query.

**GMV5 DC INVERTER VRF UNITS SERVICE MANUAL**

Select a fault to be queried by pressing "SW1 (UP)" or "SW2 (DOWN)". LED3 alternately displays the historical fault code and module address in an interval of one second in the sequence of fault records. LED2 displays the fault sequence number. If there not historical faults, LED2 and LED3 display "00" by default. Up to five historical faults can be queried. The faults that can be queried are as follows:

Code		Code	
E1	High-pressure protection	P9	Inverter compressor out-of-step protection
E3	Low-pressure protection	C2	Communication failure between the master unit and inverter compressor driver
U4	Lack of refrigerant protection	P8	Over-high temperature protection for inverter compressor driver module
E2	Discharge low-temperature protection	P7	Temperature sensor failure of inverter compressor driver module
J9	Over-low pressure ratio protection	PF	Charge circuit failure of inverter compressor driver
J8	Over-high pressure ratio protection	HL	DC bus line over-low voltage protection for inverter outdoor fan driver
J7	Four-way valve leakage protection	HH	DC bus line over-high voltage protection for inverter outdoor fan driver
E5	High-temperature protection of compressor 1	H6	Inverter outdoor fan driver IPM module protection
E6	High-temperature protection of compressor 2	HJ	Inverter outdoor fan startup failure
J2	Over-current protection of compressor 2	HE	Inverter outdoor fan phase lack protection
EU	Top high-temperature protection of compressor 1	H3	Inverter outdoor fan driver module reset
Eb	Top high-temperature protection of compressor 2	H5	Inverter outdoor fan over-current protection
PL	DC bus line over-low voltage protection for inverter compressor driver	HC	Current detection circuit failure of inverter outdoor fan driver
PH	DC bus line over-high voltage protection for inverter compressor driver	H9	Inverter outdoor fan out-of-step protection
P6	Inverter compressor driver IPM module protection	C3	Communication failure between the master unit and inverter outdoor fan driver
PJ	Inverter compressor startup failure	H8	Over-high temperature protection for inverter outdoor fan driver module
PE	Inverter compressor phase lack protection	H7	Temperature sensor failure of inverter outdoor fan driver module
P3	Inverter compressor driver module reset		
P5	Inverter compressor over-current protection		
PC	Current detection circuit failure of inverter compressor driver		

The display is as follows:

LED1		LED2		LED3	
Function Code	Display Mode	Fault Sequence	Display Mode	Current Status	Display Mode
n6	On	01	On	Historical fault/module address	Displayed alternately
n6	On	02	On		Displayed alternately
n6	On	03	On		Displayed alternately
n6	On	04	On		Displayed alternately
n6	On	05	On		Displayed alternately

"01-05" indicates the fault sequence from the earliest to the latest.

If there are less than five historical faults, LED2 and LED3 display "00" indicating there are no more historical faults after the last fault is displayed.

In fault query status, press and hold "SW7" for five seconds to clear all historical faults of the ODU.

Step 8: If the n7 parameter query is selected, the display is as follows. Enter the to-be-confirmed status of parameter query.

GMV5 DC INVERTER VRF UNITS SERVICE MANUAL

LED1		LED2		LED3	
Function Code	Display Mode	Current Progress/Mode	Display Mode	Current Status	Display Mode
n7	Blinking	00	Blinking	00	Blinking

On the master unit, press "SW7" to confirm parameter query and enter the module confirmation status for parameter query. The display is as follows:

LED1		LED2		LED3	
Function Code	Display Mode	Module Address	Display Mode	Current Status	Display Mode
n7	On	01	Blinking	00	Blinking
n7	On	02	Blinking	00	Blinking
n7	On	03	Blinking	00	Blinking
n7	On	04	Blinking	00	Blinking

Select a module for parameter query by pressing "SW1 (UP)" or "SW2 (DOWN)" and then press "SW7". The display is as follows:

LED1		LED2		LED3	
Function Code	Display Mode	Parameter Code	Display Mode	Current Status	Display Mode
n7	On	XX	On	Parameter value	Blinking

LED2 displays the parameter code of the module and LED3 displays the parameter value. Parameters are displayed in the following sequence. By default, the outdoor environment temperature value is displayed. Select a corresponding parameter value by pressing "SW1 (UP)" or "SW2 (DOWN)".

Parameter Code	Parameter Name	Unit	Remark
01	Outdoor environment temperature	°C	
02	Operation frequency of compressor 1	Hz	
03	Operation frequency of compressor 2	Hz	
04	Operation frequency of outdoor fan	Hz	
05	Module high-pressure	°C	
06	Module low-pressure	°C	
07	Discharge temperature of compressor 1	°C	
08	Discharge temperature of compressor 2	°C	
09	Discharge temperature of compressor 3	°C	This parameter is invalid for the GMV5 series.
10	Discharge temperature of compressor 4	°C	This parameter is invalid for the GMV5 series.
11	Discharge temperature of compressor 5	°C	This parameter is invalid for the GMV5 series.
12	Discharge temperature of compressor 6	°C	This parameter is invalid for the GMV5 series.

13	Operation frequency of compressor 3	Hz	This parameter is invalid for the GMV5 series.
14	Current value of compressor 1	A	
15	Current value of compressor 2	A	
16	Current value of compressor 3	A	This parameter is invalid for the GMV5 series.
17	Current value of compressor 4	A	This parameter is invalid for the GMV series.
18	Current value of compressor 5	A	This parameter is invalid for the GMV5 series.
19	Current value of compressor 6	A	This parameter is invalid for the GMV5 series.
20	Reserved		
21	Module temperature of compressor 1	°C	
22	Module temperature of compressor 2	°C	
23	Module temperature of outdoor fan 1	°C	
24	Module temperature of outdoor fan 2	°C	
25	Outdoor unit heating EXV1	PLS	
26	Outdoor unit heating EXV2	PLS	
27	Subcooler EXV	PLS	
28	Defrosting temperature	°C	
29	Liquid-extracting temperature of subcooler	°C	
30	Outlet temperature of accumulator	°C	
31	Oil return temperature	°C	This parameter is invalid for the GMV5 series.
32	Inlet-tube temperature of condenser	°C	This parameter is invalid for the GMV5 series.

Note:

If a parameter value is negative, LED3 circularly displays the negative code "nE" and the numeric value every one second. For example, for -30°C, LED3 alternately displays "nE" for one second and then "30" for another second.

The discharge temperature and environment temperature are displayed as four-digit values, circularly displaying the higher two digits and the lower two digits. For example, if "01" and "15" are alternately displayed, it indicates 115°C. If "nE", "00", and "28" are alternately displayed, it indicates -28°C.

If a parameter is invalid for the unit, "00" is displayed.

If no button operations are performed on the master unit for five minutes, the function setting automatically quits and the unit restores the current status.

Step 9: If the nb ODU bar code query is selected, the display is as follows. Enter the to-be-confirmed status of ODU bar code query.

LED1		LED2		LED3	
Function Code	Display Mode	Current Progress/Mode	Display Mode	Current Status	Display Mode
nb	Blinking	00	Blinking	00	Blinking

Press "SW7" on the master unit to enter the next-level menu selection. The display is as follows:

LED1		LED2		LED3	
Function Code	Display Mode	Module Address	Display Mode	Current Status	Display Mode
nb	On	01	Blinking	00	Blinking
nb	On	02	Blinking	00	Blinking
nb	On	03	Blinking	00	Blinking
nb	On	04	Blinking	00	Blinking

Select a module for query by pressing "SW1 (▲)" or "SW2 (▼)" and then press "SW7". The display is as follows:

LED1		LED2		LED3	
Function Code	Display Mode	Parameter Code	Display Mode	Current Status	Display Mode
nb	On	Un/Pc	Blinking	-n	Blinking

Note: Un indicates the entire-unit bar code and Pc indicates the controller bar code.

After confirming the module, select a bar code sequence by pressing "SW1 (▲)" or "SW2 (▼)". The display sequence is as follows:

Entire-unit bar code (bits 1-13) and controller bar code (bits 1-13), that is, entire-unit bar code header → entire-unit bar code (bits 1-6) → entire-unit bar code (bits 7-12) → entire-unit bar code (bit 13) → controller bar code header → controller bar code (bits 1-6) → controller bar code (bits 7-12) → controller bar code (bit 13). The display is as follows:

LED1		LED2		LED3	
Parameter Code	Display Mode	Parameter Code	Display Mode	Parameter Code	Display Mode
Code	On	Code	On	Code	On

Example:

Entire-unit bar code: N1R0128150066

Controller bar code: N1M0128150067

The display sequence is as follows:

LED1		LED2		LED3	
Parameter Code	Display Mode	Parameter Code	Display Mode	Parameter Code	Display Mode
nb	On	Un	Blinking	-n	Blinking



LED1		LED2		LED3	
Parameter Code	Display Mode	Parameter Code	Display Mode	Parameter Code	Display Mode
N1	On	R0	On	12	On



LED1		LED2		LED3	
Parameter Code	Display Mode	Parameter Code	Display Mode	Parameter Code	Display Mode
81	On	50	On	06	On



LED1		LED2		LED3	
Parameter Code	Display Mode	Parameter Code	Display Mode	Parameter Code	Display Mode
6X	On/Off	XX	Off	XX	Off



LED1		LED2		LED3	
Parameter Code	Display Mode	Parameter Code	Display Mode	Parameter Code	Display Mode
nb	On	Pc	Blinking	-n	Blinking



LED1		LED2		LED3	
Parameter Code	Display Mode	Parameter Code	Display Mode	Parameter Code	Display Mode
N1	On	M0	On	12	On



LED1		LED2		LED3	
Parameter Code	Display Mode	Parameter Code	Display Mode	Parameter Code	Display Mode
81	On	50	On	06	On



LED1		LED2		LED3	
Parameter Code	Display Mode	Parameter Code	Display Mode	Parameter Code	Display Mode
7X	On/Off	XX	Off	XX	Off

If a parameter is invalid for the unit, "00" is displayed.

On the master unit, press "SW6" to return to the upper level if there are two levels of menu. Press "SW4" to quit the query status.

If no button operations are performed on the master unit for five minutes, the function setting automatically quits and the unit restores the current status.

Step 4: In query status, press "SW4" to quit.

## 2.2.5 Basic Operations for Engineering Commissioning

### 2.2.5.1 Basic Operations

Basic Operations	Operation Method	Remark
Starting engineering commissioning	Press and hold "SW7" on the master unit for more than five seconds.	—
Selecting no-wired-controller commissioning mode	Press "SW4" and "SW5" simultaneously in any commissioning progress after the unit enters the commissioning status.	In this mode, the system does not detect the communication status between the IDU and wired controller any more. Commissioning can be performed on the IDU without configuring the wired controller.

GMV5 DC INVERTER VRF UNITS SERVICE MANUAL

Quitting engineering commissioning	In engineering commissioning status, press and hold "SW7" for more than five seconds on the master unit to quit commissioning.	—
Pausing engineering commissioning	In engineering commissioning status, press "SW6" on the master unit to retain the previous commissioning completion phase of the current commissioning phase.	This function is valid after step 9. For example, if receiving a pausing engineering commissioning signal during the process of "10. Pre-startup ODU valve status judging phase" in step 11, the system will restore the completion phase of "9. Pre-startup refrigerant judging phase" in step 10.
Continuing engineering commissioning	In engineering commissioning pause status, press "SW6" on the master unit to continue engineering commissioning.	—

2.2.5.2 Restoring Factory Settings

Restoring Factory Settings	Setting Method	Prompt for Successful Settings	Remark
Restoring setting 1	Press and hold "SW8" on the master unit for more than 10 seconds.	All LEDs blink for three seconds.	All factory settings of the ODU are restored and the unit waits for re-commissioning.
Restoring setting 2	Press and hold "SW3" and "SW8" on the master unit for more than 10 seconds.	All LEDs blink for five seconds.	Re-commissioning is not required. The number of outdoor and IDUs is memorized. Addresses of outdoor and IDUs are all cleared. All the other function settings are cleared.
Restoring setting 3	Press and hold "SW5" and "SW8" on the master unit for more than 10 seconds.	All LEDs blink for seven seconds.	Re-commissioning is not required. The number of outdoor and IDUs is memorized. Addresses of outdoor and IDUs retain the preceding settings. All the other function settings are cleared.

## 3 Commissioning Process

Note:

- ① It is forbidden to directly connect the compressor with power supply and forcibly power it on during commissioning and maintenance.
- ② Engineering commissioning operations must be performed on the GMV5 serial unit. Otherwise, the unit cannot properly run.
- ③ Before commissioning is completed, the main board of ODU displays "module address 0F A0" and that of IDU displays "A0".
- ④ A module must be set to master module and only one can be set during commissioning.
- ⑤ An IDU must be set to master IDU and only one can be set during commissioning.
- ⑥ Other functions can use the factory settings if there are not special engineering requirements.

### 3.1 Necessity of VRF Engineering Commissioning

Different from ordinary air conditioning units, the VRF system raises high design requirements and easily incurs operation-affected factors such as impurities and water during engineering installation. Due to the requirements on engineering design/installation complexity and high-precise system control, commissioning is mandatory after engineering installation. Only a qualified unit can be delivered for use.



## 3.2 Required Files and Tools for Engineering Commissioning

### 3.2.1 Required Tools for Engineering Commissioning of GREE VRF

Inner hexagon spanner	Digital thermometer
Shifting spanner	Noise meter
Cross screwdriver	Clamp meter
Straight screwdriver	Digital multimeter
Vacuum pump	Electricity meter
Electronic balance	Timer
System high and low pressure gauges for corresponding refrigerants	Step ladder
Wind-speed transmitter	

The GMV5 VRF provides two commissioning methods. One is to perform commissioning by pressing buttons on the main board of ODU. The other is to perform commissioning on a PC through professional software. Parameters of the ODU and IDU can be simultaneously displayed with the second method. (For details about these methods, refer to respective instructions.)

### 3.2.2 Commissioning Files

The following commissioning files are required to record installation and commissioning of units: pre-commissioning scheme determination meeting minutes, commissioning personnel record tables, commissioning system appearance check record tables, commissioning data record tables, and commissioning reports. See attached tables for file formats.

## 3.3 Engineering Commissioning Procedures

### 3.3.1 Step 1: Pre-commissioning Preparations

#### 3.3.1.1 Overall Commissioning Plan

Before commissioning, the person-in-charge should learn about the overall engineering progress plan, overall workload of engineering commissioning, possible influence factors in achieving the commissioning progress, and required labors and materials.

#### 3.3.1.2 Composition of Commissioning Members

Commissioning members comprise aftersales commissioning personnel and installation personnel.

All commissioning participants must take part in professional training courses before unit commissioning. All participants can be grouped as required and each group should include at least professional commissioning personnel and assistants.

#### 3.3.1.3 Preparations of Commissioning Tools and Instruments

- Make sure that the following tools or instruments are prepared before commissioning.
- Make sure that the commissioning software is correct before commissioning.
- The professional aftersales commissioning software provided by GREE should be used for commissioning of GREE VRF system.

Make sure that all required files and parameter records are prepared.

### 3.3.2 Step 2: Pre-commissioning Check

#### 3.3.2.1 Installation environment check

Installation environment check covers the heat exchange environment of unit and electromagnetic radiant components. All requirements should comply with national and local electrical standards. For any installation non-compliance, records should be made for providing an analysis basis during refrigerating system testing.

#### 3.3.2.2 Installation Appearance Check

Installation appearance check covers whether pipeline installation complies with specifications, whether refrigerant pipes and condensing drainage pipes are thermal insulated, and whether

Refrigerant pipes should be tidily installed, with outdoor and indoor dispersed pipes leaning in the required scope. For any installation non-compliance, records should be made for providing an analysis basis during refrigerating system testing.

Refrigerant pipes and condensing drainage pipes should not be exposed. If any pipe is exposed, an immediate amendment is required to avoid serious loss.

#### 3.3.2.3 Refrigerating System Check

1) Before commissioning, make sure that the stop valve of each module reaches the maximum opening degree. Check whether there is any refrigerant oil leakage around the valve. If there is, immediately check for leakage with soap bubbles or leak detectors. If confirming that leakage exists, immediately stop commissioning and solve the problem before continuing commissioning.

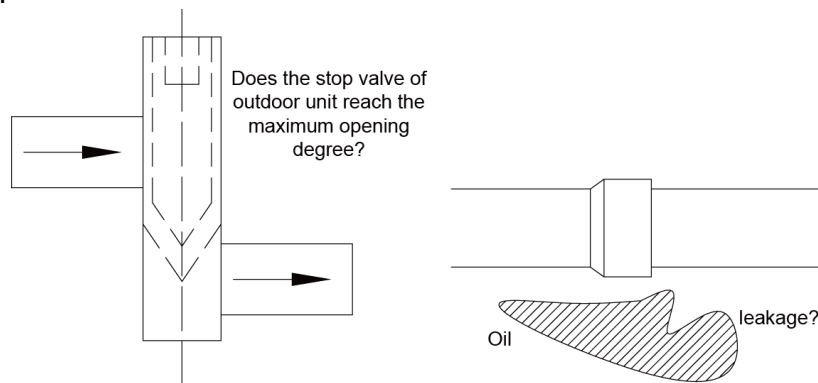

2) Check system refrigerants before startup.

Before the system is started, connect the liquid-tube valve of ODU with a high pressure gauge and the air-tube valve of ODU with a low pressure gauge, and then read their values. In this case, high pressure and low pressure of the system should be in balance status, and the difference between the saturation temperature corresponding to the balanced pressure value and the

environment temperature (the higher in outdoor and indoor temperatures is taken as environment temperature) should not be larger than 5°C. If the difference is larger than 5°C, it is required to check the ODU for leakage.

Note: Guarantee that the system has never been started before this test. Otherwise, the high pressure value will be over-higher than the environment temperature or the low pressure value will be over-lower than the environment temperature.

Example:

The outdoor environment temperature is 30°C and the indoor environment temperature is 28°C. The pressure gauges connected with the system show that the high pressure value is 28°C and the low pressure value is 27°C. The difference between the outdoor environment temperature and either pressure value is less than 5°C. It indicates that the system standby pressure is normal.

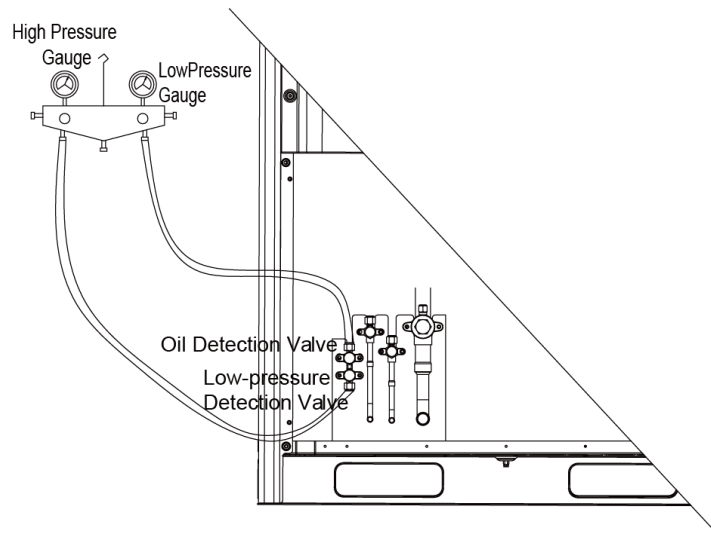

### 3.3.2.4 Electrical System Check

1) Check for high electromagnetic interference, dusts, and acidic or alkaline gas in the unit environment.

a. The air conditioning unit can neither share the same power supply system with the equipment containing variable-frequency drives, nor reside near the equipment generating high electromagnetic interference. Otherwise, the air conditioning unit may fail to properly work due to interference. If this case exists, records should be made. In the case of serious influence, the air conditioning unit must be relocated or relevant measures must be taken.

b. Prevent acidic or alkaline gas/liquid from rusting cables of the air conditioning unit.

2) Check the installation appearance of power cables.

Check whether power cables of indoor and ODUs are installed according to vendor requirements and whether cable connectors are reliably connected. Except the connection part of patch panels, wire exposure is not allowed on any connection part of power cables.

3) Check the power capacity required for the unit.

The air conditioning unit works at a current much larger than the rated current (the working current changes in a large scope in different conditions). The power grid provides unstable voltages and the line power factor decreases. Therefore, the power capacity should not be less than the maximum power of the unit.

4) Check air switches and fuse links for their models and using methods.

a. Commercial air conditioning units must be installed with independent air switches, fuse links, and similar protectors. Reasonable models and using methods should be selected for air switches and fuse links.

Remarks:

a1. Air switches work for overload and short-circuit protection. Air switches provide a less breaking current than fuse links and air switches react more slowly than fuse links. The advantage of air switches is that they can be manually reset after a protection action.

a2. Fuse links only work for short-circuit protection. They provide a large breaking current and act slowly. However, fuses must be replaced after a protection action.

b. Select air switch models according to the power cable diameter and air switch specifications. In general, the rated current of air switches should be larger than or equal to the load current calculated based on the line, and less than or equal to the persistent current rating allowed by the conductor.

5) Check components in the electric box.

In the case of unit power-off, visually check whether any component in the electric box drops during transportation. Then, check whether any component or cable is loose or drops by hand. For a large-scale unit, power cable terminals of the patch panel and cable terminals connected with connectors must be tightened with a sleeve spanner or screwdriver, and tightened once more after two months of normal operation. Auxiliary contacts of AC connectors cannot be removed because they have been debugged upon factory departure.

3.3.2.5 Check the input power.

a. Power consistency check: Measure the power supply to be connected with the air conditioning unit for its voltage, frequency, three-phase voltage unbalance factor, and frequency offset. Specifications of the power supply should be consistent with power specifications displayed on the unit nameplate. The fluctuation range of voltage should be within  $\pm 10\%$ .

b. Phase sequence check:

b1. After powering on the unit, measure the grounded voltage value of N-bit on the power patch panel and the voltage value between every two of L1, L2, and L3 bits. In general, the voltage between N-bit and L1/L2/L3-bit should approach 220 V and the voltage between every two of L1, L2, and L3 bits should approach 380 V. If the measurement result does not match the above-mentioned normal value, check whether the external power cable is inversely connected between the N wire and one of L wires.

b2. Observe the code displayed on the digital LED of the main board AP1. If the fault code "U3" is displayed, it indicates that the phase sequence of the external power cable connected with the air conditioning unit is incorrect. Power off the unit and exchange any two phases among L1, L2, and L3 bits on one end of the external power cable. Power on the unit and observe the code again. The fault code "U3" should disappear.

3.3.2.6 Communication System Check

1) The following communication contents must be checked again before commissioning:

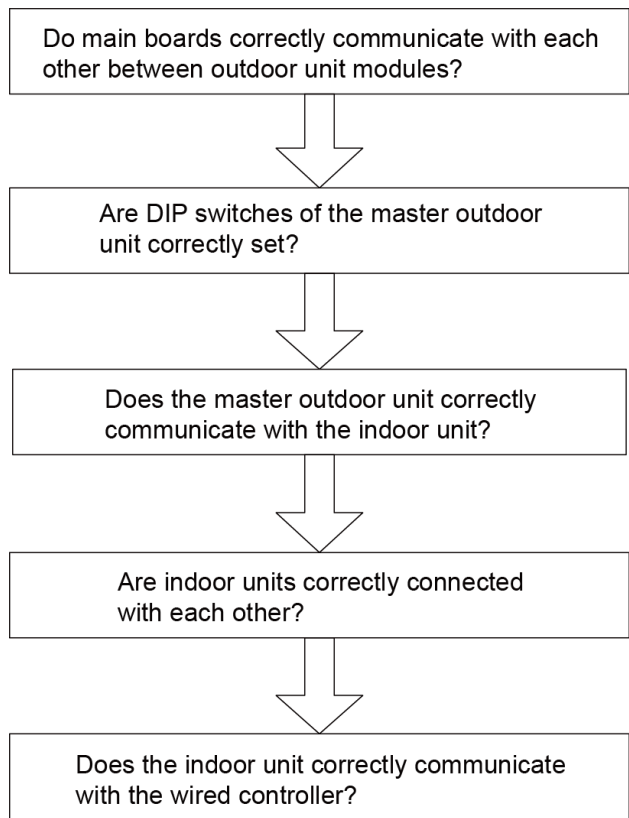

2) Communication cables cannot be laid out in the same trough as power cables. Communication cables should be independently laid out in hard fire-resistant PVC tubes. The parallel spacing between communication cables and strong electric wires should be larger than 20 cm.

## 3.3.2.7 Installation and Master of Commissioning Software

## 3.3.2.8 Spot Check

Spot Check for Commissioning		
SN	Spot Check Item	Qualified
1	Is the engineering design diagram complete?	
2	Does the construction comply with the design diagram?	
3	Is the rated capacity of the IDU/ODU of a single refrigerating system within 50%-135%?	
4	Is the number of connected IDUs in a single refrigerating system within 80?	
5	Is the access capacity of a fresh-air unit within 30%?	
6	Does the difference of level between IDUs and ODUs comply with unit design requirements?	
7	Does the difference of level between IDUs comply with unit design requirements?	
8	Are long pipes of IDUs and ODUs less than or equal to 165 m?	
9	Is the total length of pipes less than 1000 m?	
10	Is the spacing between the ODU and the first disperse pipe larger than 90 m? If yes, is the corresponding pipe diameter increased?	
11	Is the spacing between the IDU and the nearest disperse pipe larger than 40 m? If yes, is the corresponding pipe diameter increased?	
12	Does the wall thickness of copper tubes meet design requirements?	
13	Are disperse pipes horizontal or vertical?	
14	Does the diameter of cables connected with IDUs and ODUs comply with unit design requirements?	
15	Do the circuit breaker and leakage switch comply with unit design requirements?	
16	Is the spacing between the power cable and the TV set larger than 1 m?	
17	Do communication cable materials comply with unit design requirements?	
18	Are all communication cables of IDUs and ODUs serially connected?	
19	Is the last-communicating IDU installed with a communication-matched resistance?	
20	What is the load of the selected IDU model?	
21	Is the foundation of ODU firm? Do shock absorption and water drainage comply with requirements?	
22	Are basic modules installed on the same horizontal line?	
23	Does the drainage pipe of IDU retain a 1/100 ratio of slope?	
24	Is the raised height of drainage pipe of IDU less than 85 cm?	
25	Is the drainage of IDU smooth?	
26	Does a U-shaped trap exist in the drainage pipe of IDU?	
27	Are the air outlet and air return vent of IDU connected with soft connectors? Is a plenum chamber installed for air return?	
28	Is the water pipe of IDU installed with an air exhaust vent?	
29	Is "MASTER" stuck to the wired controller or panel of the master IDU?	
30	Does appending refrigerants to the system comply with requirements?	
31	Does the ODU run with static pressure? Has a static pressure value been set?	
32	Has the ODU been preheated for more than eight hours before commissioning?	

**3.3.3 Step 3: Commissioning Operation**

## 3.3.3.1 Precautions

1) Before starting commissioning, make sure that the unit compressor has been preheated for more than eight hours and check whether preheating is normal by touching. Commissioning can be started only when preheating is normal. Otherwise, the compressor may be damaged. Commissioning must be performed or guided by professional personnel.

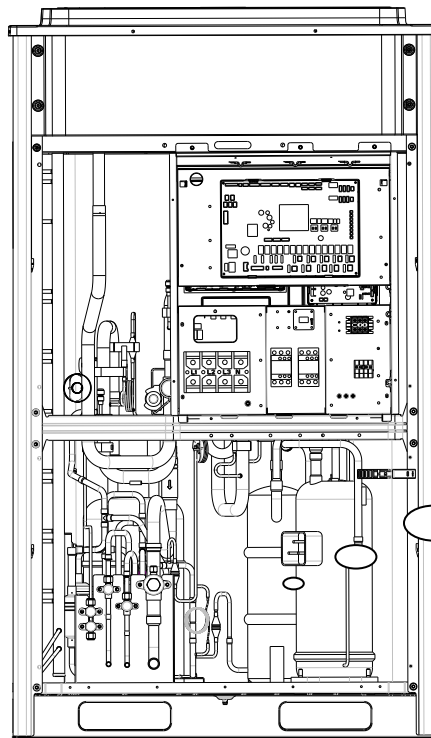

Has the compressor been preheated for more than eight hours?

2) When unit commissioning is started, the system automatically selects an operation mode according to the environment temperature:

Cooling mode when the outdoor environment temperature is higher than 20°C.

Heating mode when the outdoor environment temperature is lower than 20°C.

3) Before starting commissioning, make sure again that stop valves of all basic modules of the ODU have been completely opened.

4) During commissioning, the front panel of ODU must be completely covered. Otherwise, commissioning accuracy may be affected (as shown in the following figure).

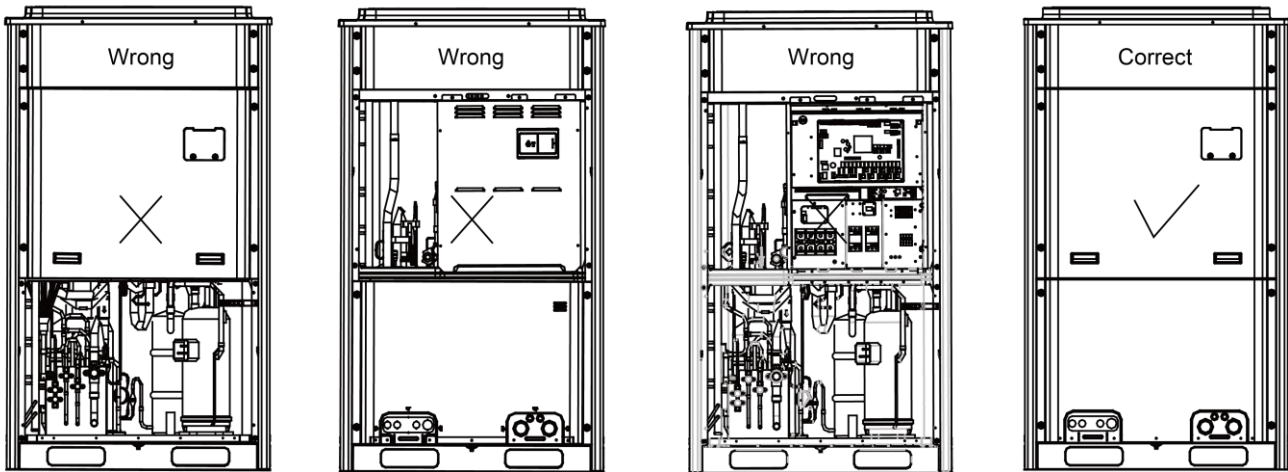

5) Before commissioning, make sure that appending refrigerants to pipes has finished completely or for more than 70%.

6) The following table describes progress display of each phase during commissioning:

Progress Description for Commissioning Phases							
—	Commissioning Code		Progress Code		Status Code		Meaning
Progress	LED1		LED2		LED3		
	Code	Display Status	Code	Display Status	Code	Display Status	
01_Master unit setting detection	db	On	01	On	A0	On	The system is in non-commissioning status.
	db	On	01	On	CC	On	The system does not set any master unit, and a master unit should be set.

GMV5 DC INVERTER VRF UNITS SERVICE MANUAL

	db	On	01	On	CF	On	The system sets more than two master units, and a master unit should be set again.
	db	On	01	On	OC	On	The system successfully sets a master unit and automatically enters the next step.
02_Unit address assignment	db	On	02	On	Ad	Blinking	The system is assigning addresses.
	db	On	02	On	L7	Blinking	There is not any master IDU, and a master IDU should be set through the commissioning software. If no master IDU is set within one minute, the system will automatically set one.
	db	On	02	On	OC	On	The system successfully assigns addresses and automatically enters the next step.
03_Basic module quantity confirmation for ODU	db	On	03	On	01-04	Blinking	LED3 displays the module quantity, which should be manually confirmed.
	db	On	03	On	OC	On	The system confirms the module quantity and automatically enters the next step.
04_Indoor unit quantity confirmation	db	On	04	On	01-80	Blinking	LED3 displays the IDU quantity, which should be manually confirmed.
	db	On	04	On	OC	On	The system confirms the IDU quantity and automatically enters the next step.
05_Internal communication detection for basic modules	db	On	05	On	C2	On	The system detects communication failure between master unit and inverter compressor driver.
	db	On	05	On	C3	On	The system detects communication failure between master unit and inverter fan driver.
	db	On	05	On	CH	On	The rated capacity ratio is over-high between IDUs and ODUs.
	db	On	05	On	CL	On	The rated capacity ratio is over-low between IDUs and ODUs.
	db	On	05	On	OC	On	The system completes detection and automatically enters the next step.
06_Internal component detection for basic modules	db	On	06	On	Corresponding fault code	On	The system detects component failure of ODU.
	db	On	06	On	OC	On	The system detects that no ODU component fails and automatically enters the next step.
07_Component detection for IDU	db	On	07	On	XXXX/ Corresponding fault code	On	The system detects component failure of IDU. "XXXX" indicates the project number of the faulty IDU. The corresponding fault code is displayed after three seconds. For example, if a d5 fault occurs on IDU

GMV5 DC INVERTER VRF UNITS SERVICE MANUAL

							100, LED3 will circularly display "01", "00" (two seconds later), and "d5" (two seconds later).
	db	On	07	On	OC	On	The system detects that no IDU component fails and automatically enters the next step.
08_Compress or preheating confirmation	db	On	08	On	U0	On	The system gives a prompt if the compressor preheating period is less than eight hours.
	db	On	08	On	OC	On	The system detects that the compressor preheating period is more than eight hours and automatically enters the next step.
09_Pre-startup refrigerant detection	db	On	09	On	U4	On	The system detects insufficient refrigerants and stops to balance the pressure lower than 0.3 MPa.
	db	On	09	On	OC	On	The system detects that refrigerants are normal and automatically enters the next step.
10_Pre-startup ODU valve status detection	db	On	10	On	ON	On	Outdoor unit valves are being opened.
	db	On	10	On	U6	On	Outdoor unit valves have not been completely opened.
	db	On	10	On	OC	On	Outdoor unit valves have been properly opened.
11_Manually calculated refrigerant perfusion status	db	On	11	On	AE	On	The refrigerant perfusion status is manually calculated (appended refrigerants must be accurately calculated).
12_Unit commissioning startup confirmation	db	On	12	On	AP	Blinking	The system waits for a unit commissioning startup command.
	db	On	12	On	AE	On	The unit is set to manually-calculated refrigerant perfusion commissioning operation status.
13_	—	—	—	—	—	—	No meaning.
14_	—	—	—	—	—	—	No meaning.
15_Cooling operation by manual perfusion	db	On	15	On	AC	On	The system is in cooling-mode commissioning operation (the system automatically selects the commissioning operation mode without needing manual settings).
	db	On	15	On	Corresponding fault code	On	A fault occurs on the cooling-mode commissioning operation.
	db	On	15	On	J0	On	A fault occurs on other modules during the cooling-mode commissioning operation.
	db	On	15	On	U9	On	A fault occurs on ODU pipes or valves.
	db	On	15	On	XXXX/U8	On	The system detects pipe failure of IDU. "XXXX" indicates the project



GMV5 DC INVERTER VRF UNITS SERVICE MANUAL

							number of the faulty IDU. The fault code "U8" is displayed after three seconds. For example, if a U8 fault occurs on IDU 100, LED3 will circularly display "01", "00" (two seconds later), and "U8" (two seconds later).
16_Heating operation by manual perfusion	db	On	16	On	AH	On	The system is in heating-mode commissioning operation (the system automatically selects the commissioning operation mode without needing manual settings).
	db	On	16	On	Corresponding fault code	On	A fault occurs on the heating-mode commissioning operation.
	db	On	16	On	J0	On	A fault occurs on other modules during the heating-mode commissioning operation.
	db	On	16	On	U9	On	A fault occurs on ODU pipes or valves.
	db	On	16	On	XXXX/U8	On	The system detects pipe failure of IDU. "XXXX" indicates the project number of the faulty IDU. The fault code "U8" is displayed after three seconds. For example, if a U8 fault occurs on IDU 100, LED3 will circularly display "01", "00" (two seconds later), and "U8" (two seconds later).
17_Commissioning completion status	01-04	On	OF	On	OF	On	The unit has completed commissioning and in standby status. LED1 displays the module address; LED2 and LED3 display "OF".

Note: In commissioning status, press and hold "SW4" and "SW5" simultaneously for more than five seconds to enter the no-wired-controller commissioning mode. In this mode, the system does not detect the communication status between the wired controller and IDU.

### 3.3.3.2 Commissioning Operation Mode

The VRF provides two commissioning methods. One is to perform commissioning through the main board of ODU. The other is to perform commissioning on a PC through professional software. Parameters of the ODU and IDU can be simultaneously displayed and historical data can be stored and queried with the second method. (For details about these methods, refer to respective instructions.)

#### 3.3.3.2.1 Commissioning Through the Main Board of ODU

When unit commissioning is performed through the main board of ODU, the main board provides the following commissioning operation functions:

Step 1: Completely cover the front panel of ODU and open commissioning windows of all basic modules.

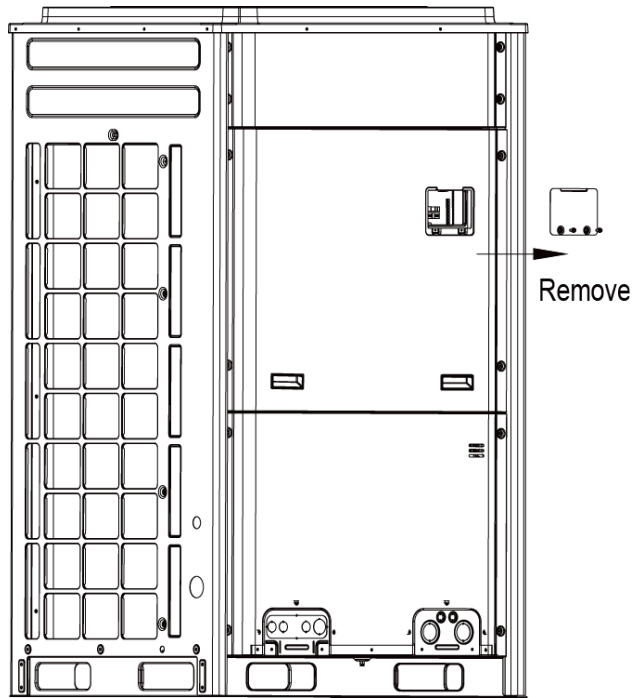

Step 2: In power-off status of ODU, set the ODU to a corresponding static pressure mode according to static pressure design requirements for outdoor engineering. For details about the setting method, see the "Outdoor Fan Static Pressure Setting DIP Switch (SA6\_ESP\_S)" section. If there are not static pressure requirements, retain the factory settings.

Step 3: In power-off status of ODU, set one module of ODU to master unit and other modules to sub-modules. For details about the setting method, see the "Master Unit Setting DIP Switch (SA8\_MASTER-S)" section.

Step 4: If centralized control is required, set the centralized control address in power-off status of ODU. For details about the setting method, see the "Centralized Control Address DIP Switch (SA2\_Addr-CC)" section. If centralized control is not required, retain the factory settings.

Step 5: Power on all outdoor and IDUs. If LED3 displays "A0" on main boards of all modules of ODU and the wired controller of each IDU displays "A0", it indicates that the unit is in non-commissioning status.

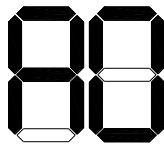

LED3

Step 6: Find the module with its address being "01", which is the master unit. On the master unit, press and hold "SW7" for more than five seconds to enter unit commissioning.

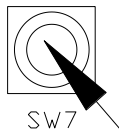

Step 7: Wait for the unit to automatically operate commissioning steps 01 and 02.

Exception 1: If the master unit is incorrectly set in step 01, the following faults are displayed in step 01:

Progress	Commissioning Code		Progress Code		Status Code		Meaning
	LED1		LED2		LED3		
	Code	Display Status	Code	Display Status	Code	Display Status	
01_Master unit settings	db	On	01	On	CC	On	The system does not set any master unit, and a master unit should be set.
	db	On	01	On	CF	On	The system sets more than two master units, and a master unit

**GMV5 DC INVERTER VRF UNITS SERVICE MANUAL**

							should be set again.
	db	On	01	On	OC	On	The system successfully sets a master unit and automatically enters the next step.

According to the above fault symptoms, set the master unit again by referring to the setting method in the "Master Unit Setting DIP Switch (SA8\_MASTER-S)" section. Then enter unit commissioning again.

Exception 2: If no master IDU is detected in step 02, the following faults are displayed in step 02:

LED1		LED2		LED3	
Function Code	Display Mode	Current Progress	Display Mode	Current Status	Display Mode
db	On	02	On	L7	Blinking

In this case, all buttons are invalid. Users can set the master IDU through the commissioning software, wired controller, or commissioning remote controller within one minute. If no master IDU is set within one minute, the system will automatically set a master IDU. Then the system automatically enters the next step.

Step 8: When the unit runs to step 03, users need to manually confirm the number of outdoor modules. The main board of each module is displayed as follows:

Progress	Commissioning Code		Progress Code		Status Code	
	LED1		LED2		LED3	
	Code	Display Status	Code	Display Status	Code	Display Status
03_Module quantity confirmation	db	On	03	On	Module quantity	Blinking

If the displayed quantity is consistent with the number of actually connected modules, press "SW7" on the master unit to confirm. The main board is displayed as follows and the unit automatically enters commissioning step 04.

Progress	Commissioning Code		Progress Code		Status Code	
	LED1		LED2		LED3	
	Code	Display Status	Code	Display Status	Code	Display Status
03_Module quantity confirmation	db	On	03	On	OC	On

If the displayed quantity is inconsistent with the number of actually connected modules, check whether communication cables are correctly connected between modules in power-off status. Then perform commissioning again.

Note: It is very important to correctly confirm the number of ODUs. If the confirmed quantity is inconsistent with the actual quantity, the system may improperly run.

Step 9: When the unit runs to step 04, users need to manually confirm the number of indoor modules. The main board of each module is displayed as follows:

Progress	Commissioning Code		Progress Code		Status Code	
	LED1		LED2		LED3	
	Code	Display Status	Code	Display Status	Code	Display Status
04_Indoor unit quantity confirmation	db	On	04	On	Number of connected IDUs	Blinking

If the displayed quantity is consistent with the number of actually connected modules, press "SW7" on the master unit to confirm. The main board is displayed as follows and the unit automatically enters the next commissioning step.

Progress	Commissioning Code		Progress Code		Status Code	
	LED1		LED2		LED3	
	Code	Display Status	Code	Display Status	Code	Display Status
04_Indoor unit quantity confirmation	db	On	04	On	OC	On

Note: It is very important to correctly confirm the number of IDUs. If the confirmed quantity is inconsistent with the actual quantity, the system may improperly run.

Step 10: Unit commissioning step 05 is internal communication detection.

If no exception is detected, the main board is displayed as follows and the unit automatically enters the next commissioning step.

Progress	Commissioning Code		Progress Code		Status Code		Meaning
	LED1		LED2		LED3		
	Code	Display Status	Code	Display Status	Code	Display Status	
05_Internal communication detection	db	On	05	On	OC	On	The system completes detection and automatically enters the next step.

If an exception is detected, the unit retains the current status and waits for manual troubleshooting. Corresponding faults include:

Progress	Commissioning Code		Progress Code		Status Code		Meaning
	LED1		LED2		LED3		
	Code	Display Status	Code	Display Status	Code	Display Status	
05_Internal communication detection	db	On	05	On	C2	On	The system detects communication failure between master unit and inverter compressor driver.
	db	On	05	On	C3	On	The system detects communication failure between master unit and inverter fan driver.
	db	On	05	On	CH	On	The rated capacity ratio is over-high between indoor and ODUs.
	db	On	05	On	CL	On	The rated capacity ratio is over-low between indoor and ODUs.

For details about the above troubleshooting method, refer to the "Troubleshooting Method" part.

Step 11: Unit commissioning step 06 is component detection for ODU.

If no exception is detected, the main board is displayed as follows and the unit automatically enters the next commissioning step.

Progress	Commissioning Code		Progress Code		Status Code		Meaning
	LED1		LED2		LED3		
	Code	Display Status	Code	Display Status	Code	Display Status	
06_Component detection for ODU	db	On	06	On	OC	On	The system detects that no ODU component fails and automatically enters the next step.

If an exception is detected, the unit retains the current status and waits for manual troubleshooting. Corresponding faults include:

Progress	Commissioning Code		Progress Code		Status Code		Meaning
	LED1		LED2		LED3		
	Code	Display Status	Code	Display Status	Code	Display Status	
06_Component detection for ODU	db	On	06	On	Corresponding fault code	On	The system detects component failure of ODU.

For details about the above troubleshooting method, refer to the "Troubleshooting Method" part.

Step 12: Unit commissioning step 07 is component detection for IDU.

If no exception is detected, the main board is displayed as follows and the unit automatically enters the next commissioning step.

Progress	Commissioning Code		Progress Code		Status Code		Meaning
	LED1		LED2		LED3		
	Code	Display	Code	Display	Code	Display	

**GMV5 DC INVERTER VRF UNITS SERVICE MANUAL**

		Status		Status		Status	
07_Component detection for IDU	db	On	07	On	OC	On	The system detects that no IDU component fails and automatically enters the next step.

If an exception is detected, the unit retains the current status and waits for manual troubleshooting. Corresponding faults include:

Progress	Commissioning Code		Progress Code		Status Code		Meaning
	LED1		LED2		LED3		
	Code	Display Status	Code	Display Status	Code	Display Status	
07_Component detection for IDU	db	On	07	On	XXXX/Corresponding fault code	On	The system detects component failure of IDU.

"XXXX" indicates the project number of the faulty IDU. The corresponding fault code is displayed after three seconds. For example, if a d5 fault occurs on IDU 100, LED3 will circularly display "01", "00" (two seconds later), and "d5" (two seconds later).

For details about the above troubleshooting method, refer to the "Troubleshooting Method" part.

Step 13: Unit commissioning step 08 is compressor preheating confirmation.

If it is detected that the compressor preheating period is more than eight hours, the main board is displayed as follows and the unit automatically enters the next step.

Progress	Commissioning Code		Progress Code		Status Code		Meaning
	LED1		LED2		LED3		
	Code	Display Status	Code	Display Status	Code	Display Status	
08_Compressor preheating confirmation	db	On	08	On	OC	On	The system detects that the compressor preheating period is more than eight hours and automatically enters the next step.

If it is detected that the compressor preheating period is less than eight hours, an exception is prompted and the main board is displayed as follows. In this case, press "SW7" to skip the waiting time and automatically enter the next commissioning step. However, the compressor may be damaged if it is forcibly started.

Progress	Commissioning Code		Progress Code		Status Code		Meaning
	LED1		LED2		LED3		
	Code	Display Status	Code	Display Status	Code	Display Status	
08_Compressor preheating confirmation	db	On	08	On	U0	On	The system gives a prompt if the compressor preheating period is less than eight hours.

Step 14: Unit commissioning step 09 is pre-startup refrigerant confirmation.

If the refrigerant volume meets the system startup requirements, the main board is displayed as follows and the unit automatically enters the next commissioning step.

Progress	Commissioning Code		Progress Code		Status Code		Meaning
	LED1		LED2		LED3		
	Code	Display Status	Code	Display Status	Code	Display Status	
09_Pre-startup refrigerant detection	db	On	09	On	0C	On	The system detects that refrigerants are normal and automatically enters the next step.

If no refrigerant exists in the system or the refrigerant volume does not meet the system startup requirements, "U4 lack of refrigerant protection" is prompted and the main board is displayed as follows. The unit cannot enter the next commissioning step. In this case, check for leakage or append refrigerants till the exception disappears.

	Commissioning	Progress Code	Status Code	Meaning
--	---------------	---------------	-------------	---------

**GMV5 DC INVERTER VRF UNITS SERVICE MANUAL**

Progress	Code		LED2		LED3		
	LED1		LED2		LED3		
	Code	Display Status	Code	Display Status	Code	Display Status	
09_Pre-startup refrigerant detection	db	On	09	On	U4	On	The system detects insufficient refrigerants and stops to balance the pressure lower than 0.3 MPa.

Step 15: Unit commissioning step 10 is pre-startup ODU valve status detection.

If the master unit is displayed as follows, it indicates that the unit is being enabled.

Progress	Commissioning Code		Progress Code		Status Code		Meaning
	LED1		LED2		LED3		
	Code	Display Status	Code	Display Status	Code	Display Status	
10_Pre-startup ODU valve status detection	db	On	10	On	ON	On	Outdoor unit valves are being opened.

If the master unit is displayed as follows, it is required to check again whether the ODU valves are completely opened.

Progress	Commissioning Code		Progress Code		Status Code		Meaning
	LED1		LED2		LED3		
	Code	Display Status	Code	Display Status	Code	Display Status	
10_Pre-startup ODU valve status detection	db	On	10	On	U6	On	It is required to check again whether the ODU valves are completely opened.

After confirming that all valves are completely opened, press "SW7" to enter the next commissioning step.

If it is detected that the unit valve status is normal, the main board is displayed as follows and the unit automatically enters the next commissioning step.

Progress	Commissioning Code		Progress Code		Status Code		Meaning
	LED1		LED2		LED3		
	Code	Display Status	Code	Display Status	Code	Display Status	
10_Pre-startup ODU valve status detection	db	On	10	On	OC	On	Outdoor unit valves have been properly opened.

Step 16: Unit commissioning step 11 is manually calculated refrigerant perfusion status.

Without operations, the system gives a function prompt and automatically enters the next step.

Step 17: Unit commissioning step 12 is unit commissioning startup confirmation.

To avoid enabling the unit before all preparations are completed, it is required to confirm again whether to enable the unit.

If the master unit is displayed as follows, it indicates that the unit is waiting for enabling confirmation.

Progress	Commissioning Code		Progress Code		Status Code		Meaning
	LED1		LED2		LED3		
	Code	Display Status	Code	Display Status	Code	Display Status	
12_Unit commissioning startup confirmation	db	On	12	On	AP	Blinking	The system waits for a unit commissioning startup command.

If it is confirmed to enable the unit, press "SW7". The main board is displayed as follows and the unit automatically enters the next commissioning step.

**GMV5 DC INVERTER VRF UNITS SERVICE MANUAL**

Progress	Commissioning Code		Progress Code		Status Code		Meaning
	LED1		LED2		LED3		
	Code	Display Status	Code	Display Status	Code	Display Status	
12_Unit commissioning startup confirmation	db	On	12	On	AE	On	The unit is set to manually-calculated refrigerant perfusion commissioning status.

Step 18: After unit startup confirmation, the system automatically selects the cooling or heating mode according to the environment temperature.

A. If the system selects the cooling mode, the main board is displayed as follows:

Progress	Commissioning Code		Progress Code		Status Code		Meaning
	LED1		LED2		LED3		
	Code	Display Status	Code	Display Status	Code	Display Status	
15_Cooling commissioning operation	Db	On	15	On	AC	On	The system is in cooling-mode commissioning operation (the system automatically selects the commissioning operation mode without needing manual settings).
	Db	On	15	On	Corresponding fault code	On	A fault occurs on the cooling-mode commissioning operation.
	Db	On	15	On	J0	On	A fault occurs on other modules during the cooling-mode commissioning operation.
	Db	On	15	On	U9	On	A fault occurs on ODU pipes.
	Db	On	15	On	XXXX/U8	On	The system detects pipe failure of IDU. "XXXX" indicates the project number of the faulty IDU. The fault code "U8" is displayed after three seconds. For example, if a U8 fault occurs on IDU 100, LED3 will circularly display "01", "00" (two seconds later), and "U8" (two seconds later).

B. If the system selects the heating mode, the main board is displayed as follows:

Progress	Commissioning Code		Progress Code		Status Code		Meaning
	LED1		LED2		LED3		
	Code	Display Status	Code	Display Status	Code	Display Status	
16_Heating commissioning operation	db	On	16	On	AH	On	The system is in heating-mode commissioning operation (the system automatically selects the commissioning operation mode without needing manual settings).
	db	On	16	On	Corresponding fault code	On	A fault occurs on the heating-mode commissioning operation.
	db	On	16	On	J0	On	A fault occurs on other modules during the heating-mode commissioning operation.
	db	On	16	On	U9	On	A fault occurs on ODU pipes.
	db	On	16	On	XXXX/U8	On	The system detects pipe failure of IDU. "XXXX" indicates the project number of the faulty IDU. The fault code "U8" is displayed after three seconds. For example, if a U8 fault occurs on IDU 100, LED3 will circularly display "01", "00" (two seconds later), and "U8" (two seconds later).

Step 19: If no exception occurs when the unit continuously operates for 40 minutes, the

system automatically confirms commissioning completion, stops the entire unit, and restores the standby status. The main board is displayed as follows:

Progress	Commissioning Code		Progress Code		Status Code		Meaning
	LED1		LED2		LED3		
	Code	Display Status	Code	Display Status	Code	Display Status	
17_Commissioning completion status	01~04	On	OF	On	OF	On	The unit has completed commissioning and in standby status. LED1 displays the module address; LED2 and LED3 display "OF".

Step 20: After unit commissioning is completed, set unit functions according to the actual engineering requirements on functions. For details about the setting method, refer to the "System Function Setting Method" part. Skip this step if there are not special requirements.

Step 21: Deliver the unit for use and let users know the precautions.

### 3.3.3.2.2 Commissioning Through the Commissioning Software

Step1: Install commissioning software to the computer and connect monitoring communication cables (for details about the operation method, see the "GREE Central Air Conditioning Commissioning Software" section).

Step 2: Completely cover the front panel of ODU.

Step 3: In power-off status of ODU, set the ODU to a corresponding static pressure mode according to static pressure design requirements for outdoor engineering. For details about the setting method, see the "Outdoor Fan Static Pressure Setting DIP Switch (SA6\_ESP\_S)" section.

Step 4: In power-off status of ODU, set one module of ODU to master unit. For details about the setting method, see the "Master Unit Setting DIP Switch (SA8\_MASTER-S)" section.

Step 5: Power on all outdoor and IDUs. In this case, all modules of ODU display that the unit is in non-commissioning status.

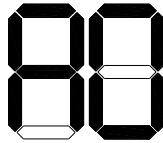

LED3

Step 6: Switch the commissioning software to the commissioning control interface.

Click "Debug" to switch to the engineering commissioning interface. The unit will automatically operate the commissioning modules listed in this interface from top to bottom and from left to right.

Note: The commissioning function only applies to the single-system network.



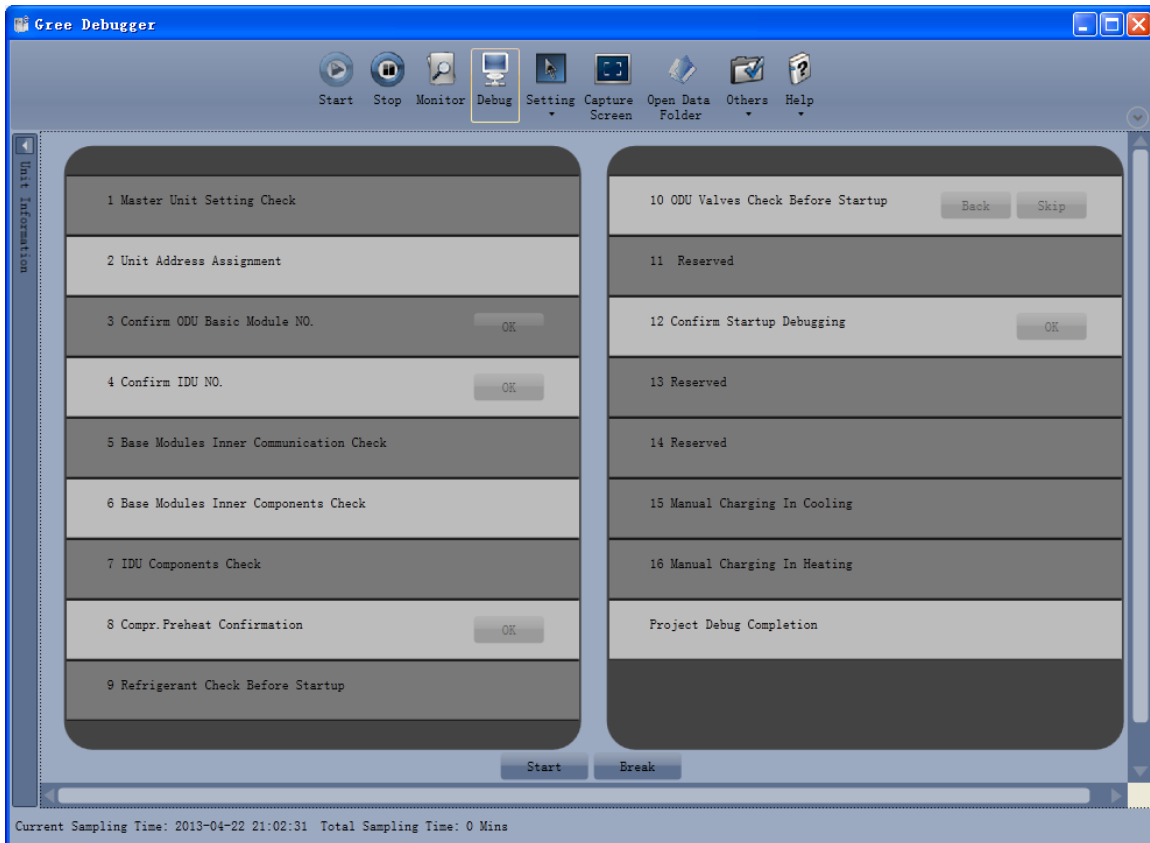

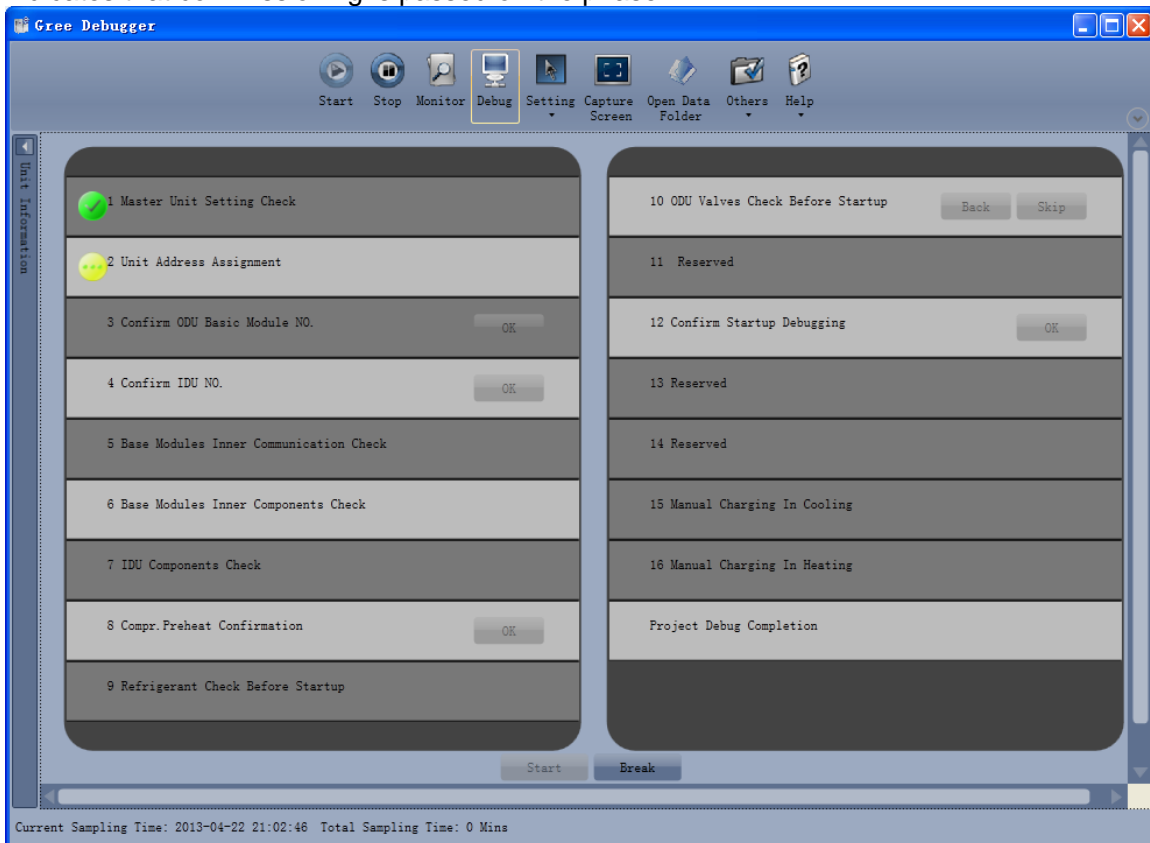

Click "Start" to enter the commissioning function and the software automatically performs commissioning. "🟢" indicates that commissioning is being performed on the phase and "🟡" indicates that commissioning is passed on the phase.

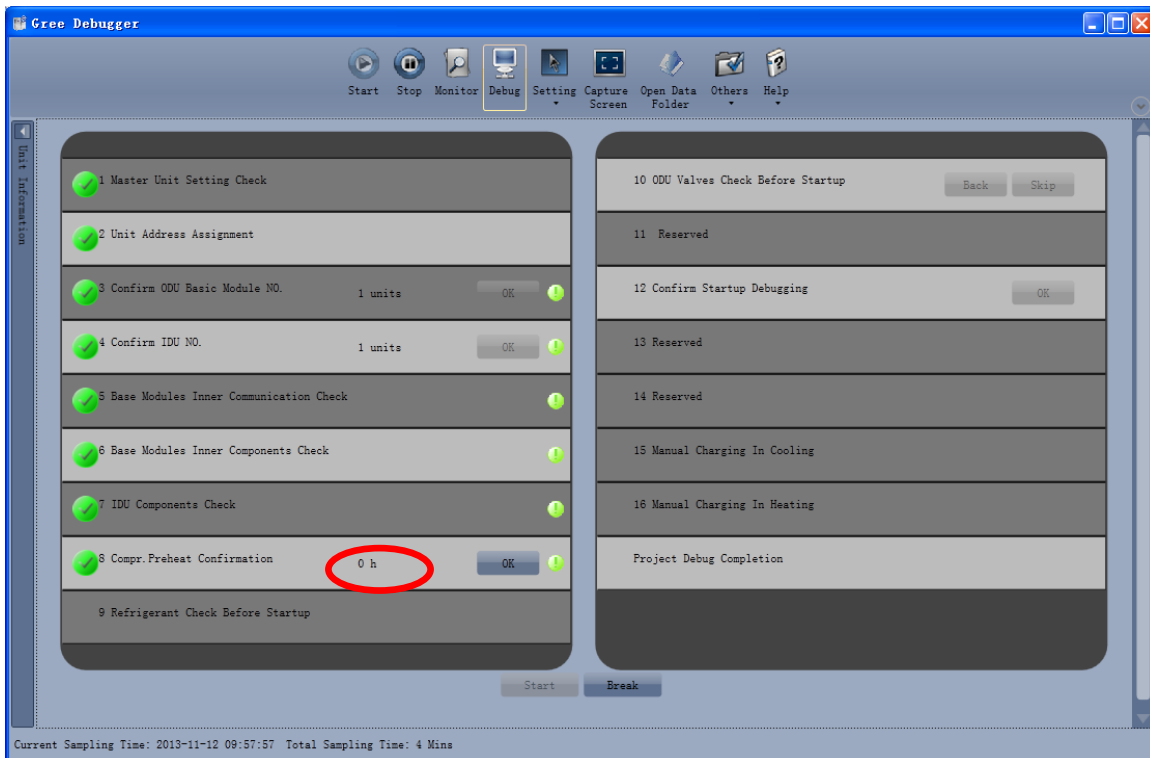
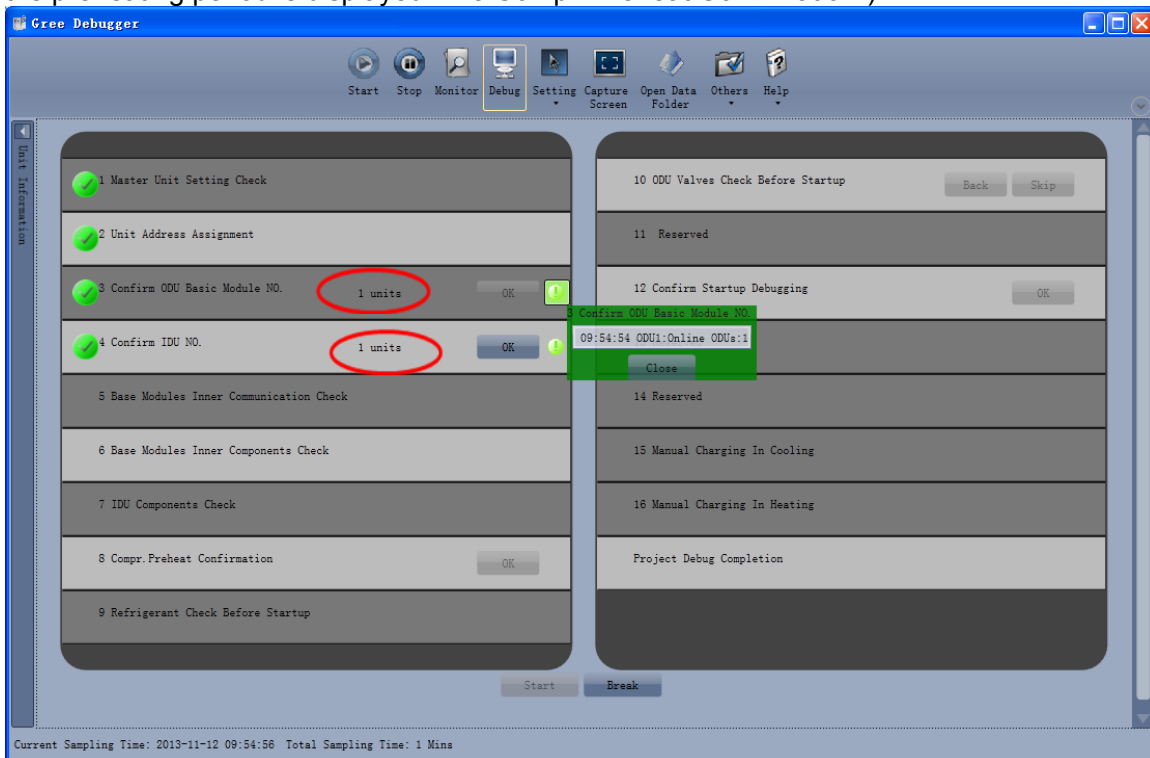

For the phase with "OK" displayed, a manual confirmation is required for entering the next commissioning step. Click "🟡" to display relevant information detected on this phase, which

provides references for selection. Click "Close" to close the information (the number of commissioning units is displayed in "3 Confirm ODU Basic Module NO." and "4 Confirm IDU NO."; the preheating period is displayed in "8 Compr. Preheat Confirmation").



"" indicates that commissioning is not passed on the phase and troubleshooting is required (after troubleshooting, the unit automatically enters the next step if no "OK" exists or click "OK" to enter the next step). Click "" to display relevant information detected on this phase, which provides references for troubleshooting. Click "Close" to close the information.

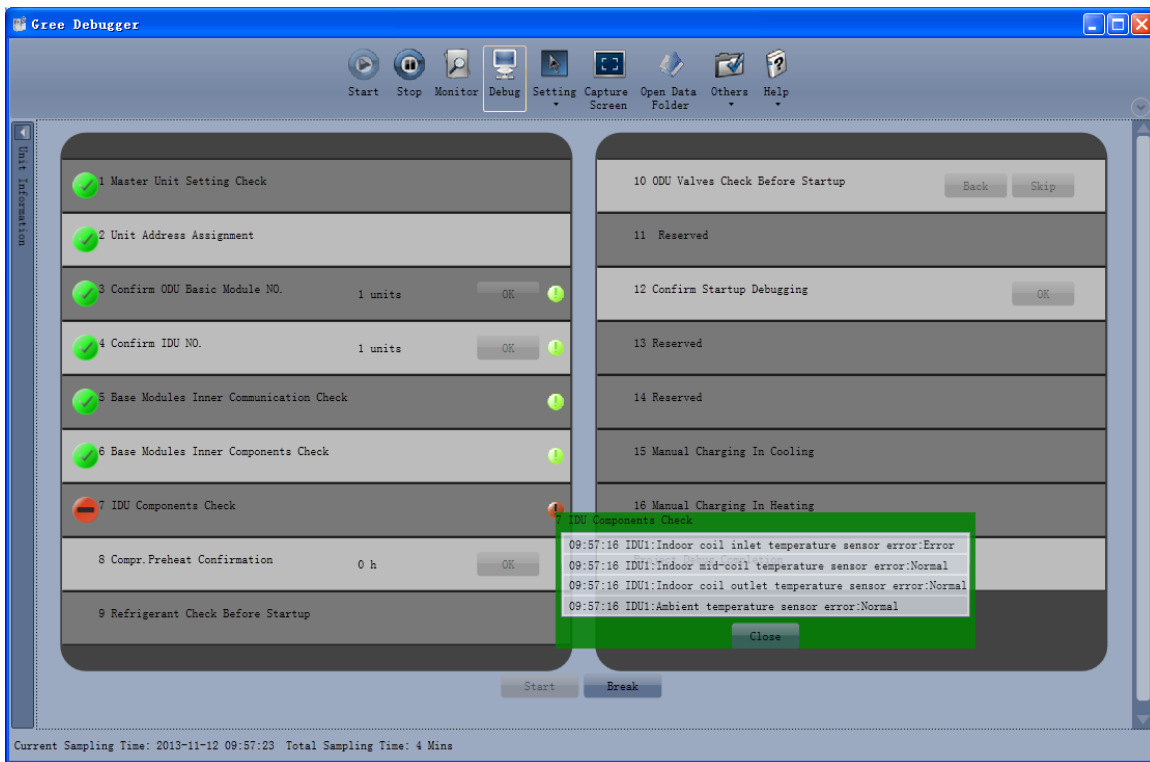

During commissioning, click "Stop" to stop commissioning and then click "Start" to continue commissioning till commissioning ends. "Back" and "Skip" are provided in "10 ODU Valves Check Before Startup". When an exception occurs in step 10, click "Back" to return to step 9 and then click "OK" in step 9 to perform commissioning again for step 10. If a U6 fault (valve exception) occurs in step 10, users can click "Skip" to skip the fault. For other faults, "Skip" is unavailable.

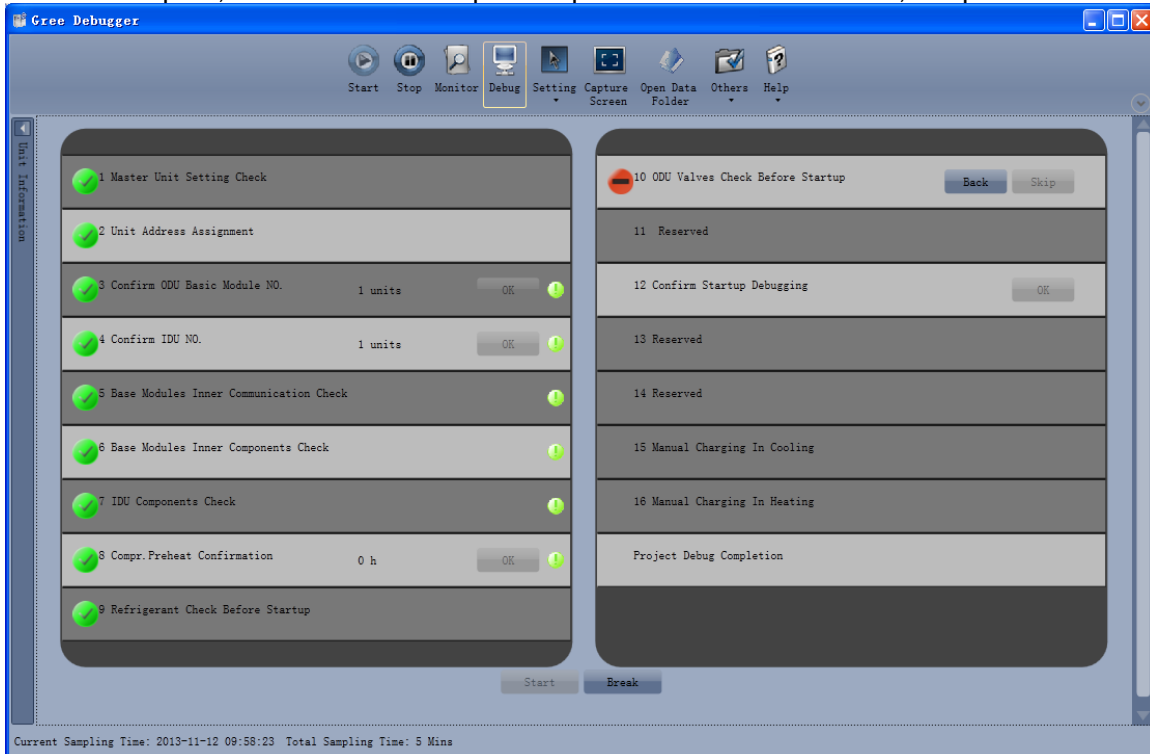

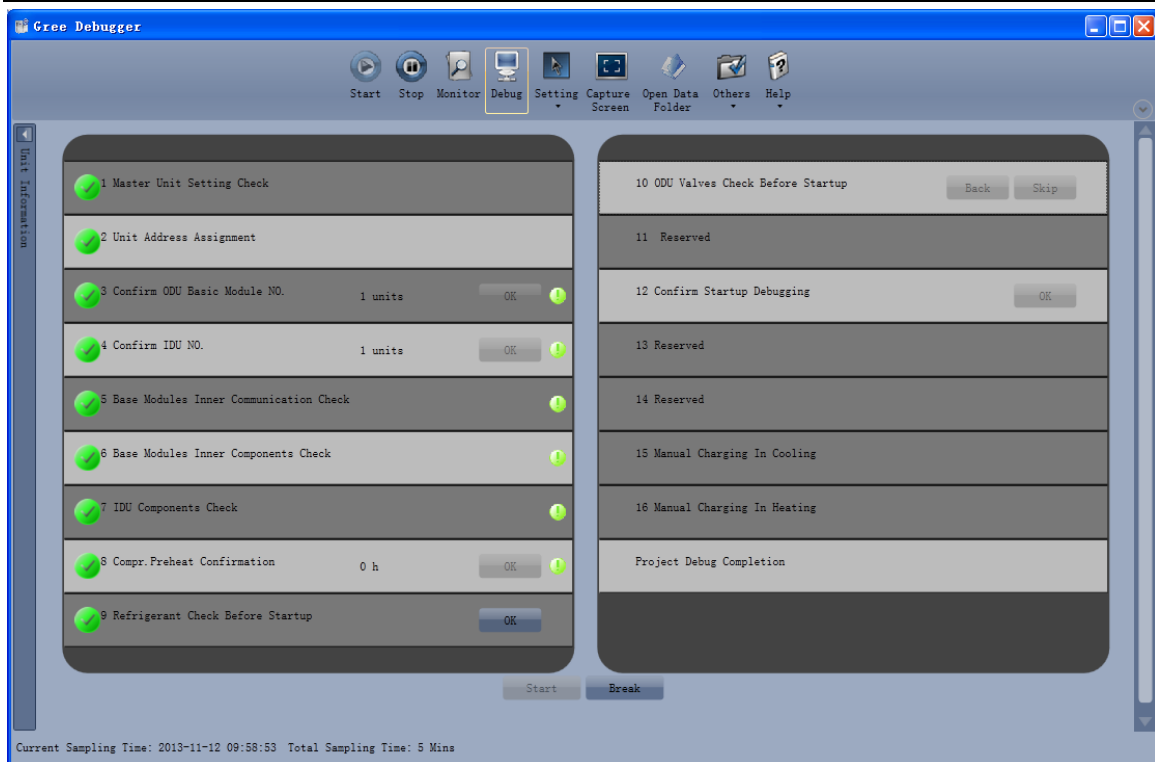

Commissioning steps 11, 13, and 14 are reserved. Steps 13, 14, 15, and 16 are parallel steps (one of the four steps will be selected according to the actual unit).

At last, engineering commissioning is completed when "  " is displayed on "Project Debug Completion".

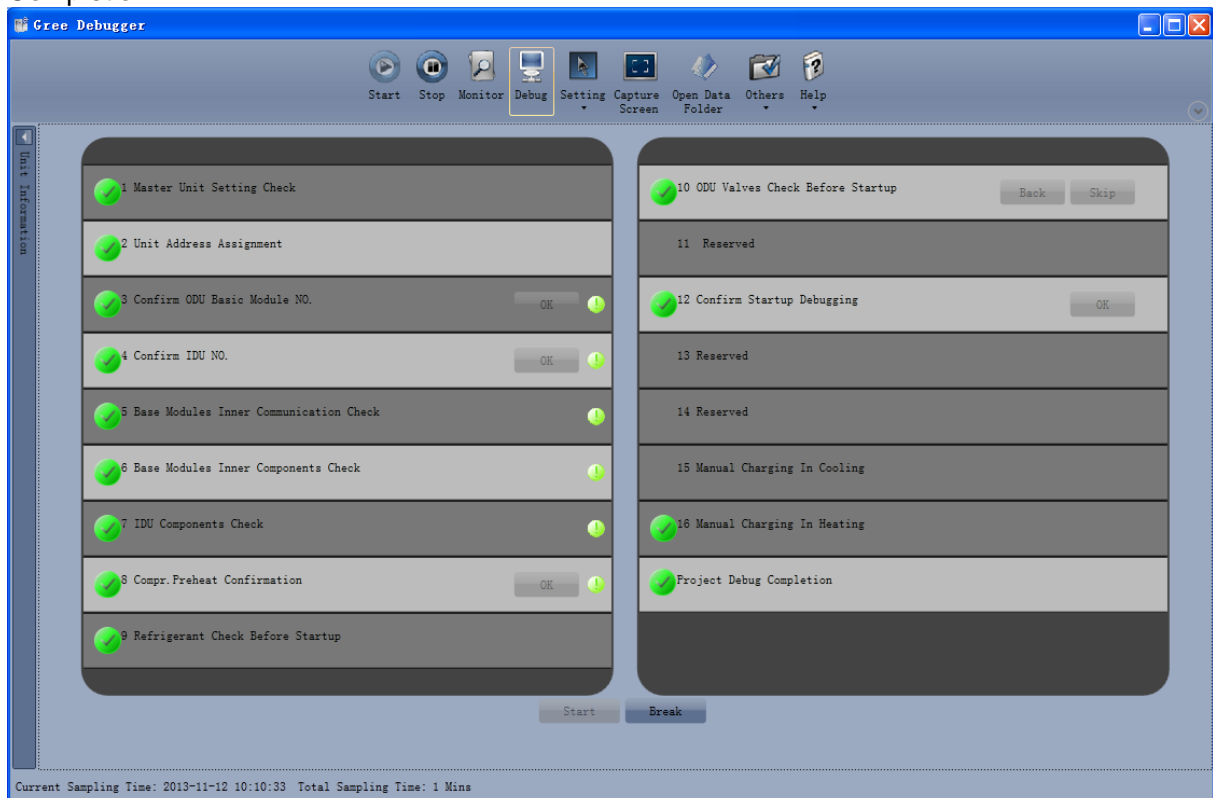

Note: During commissioning, users must listen to the operating sound of outdoor and indoor fans and compressors to check for exceptions.

### 3.3.3.3 Operations after Commissioning

Sort and save data. Make detailed records of exceptions and troubleshooting methods during commissioning for later maintenance and query. At last, make a commissioning report and hand it over to users.

#### 3.3.3.4 Precautions to Let Users Know after Commissioning

① Let users know where the master IDU is located and stick a label to the master IDU. Tell users that modes of other IDUs are limited by the mode of master IDU.

② An ODU that has been in power-off status for more than 24 hours should be preheated for more than eight hours before startup to prevent damaging compressors.

## 3.4 References for Proper Unit Operation Parameters

SN	Commissioning Item		Parameter Name	Unit	Reference Value
1	System parameter	Outdoor unit parameter	Outdoor environment temperature	°C	—
2			Discharge pipe temperature of compressor	°C	<ul style="list-style-type: none"> <li>When the system compressor is running, the normal discharge pipe or top temperature for cooling is 70-95°C, which is more than 10°C higher than the saturation temperature corresponding to the system high-pressure. The normal temperature for heating is 65-80°C, which is more than 10°C higher than the saturation temperature corresponding to the system high-pressure.</li> </ul>
3			Defrosting temperature	°C	<ul style="list-style-type: none"> <li>When the system runs for cooling, the defrosting temperature is 5-11°C lower than the system high-pressure value.</li> <li>When the system runs for heating, the defrosting temperature is 2°C higher or lower than the system low-pressure value.</li> </ul>
4			System high-pressure	°C	<ul style="list-style-type: none"> <li>The normal system high-pressure value is 20-55°C. With the change of environment temperature and system operation capacity, the system high-pressure value is 10-40°C higher than the environment temperature. The higher the environment temperature, the less the temperature difference.</li> <li>When the system runs for cooling with the environment temperature being 25-35°C, the system high-pressure value is 44-53°C.</li> <li>When the system runs for cooling with the environment temperature being -5 to 10°C, the system high-pressure value is 40-52°C.</li> </ul>
5			System low-pressure	°C	<ul style="list-style-type: none"> <li>When the system runs for cooling with the environment temperature being 25-35°C, the system low-pressure value is 0-8°C.</li> <li>When the system runs for cooling with the environment temperature being -5 to 10°C, the system low-pressure value is -15 to 5°C.</li> </ul>
6			Opening degree of heating electronic expansion valves	PLS	<ul style="list-style-type: none"> <li>During the cooling operation, the heating electronic expansion valves always remain at 480 PLS.</li> <li>During the heating operation, the adjustable electronic expansion valves change between 120 and 480 PLS.</li> </ul>
7			Operation frequency of inverter compressor	Hz	<ul style="list-style-type: none"> <li>The operation frequency of inverter compressor 1 changes between 20 and 95 Hz.</li> <li>The operation frequency of inverter compressor 2 changes between 30 and 100 Hz.</li> </ul>
8			Current of inverter compressor	A	<ul style="list-style-type: none"> <li>According to different operation frequencies and loads, the current of inverter compressor 1 changes between 7 and 25 A. The current of inverter compressor 2 changes between 7 and 20 A.</li> </ul>
9			IPM module temperature of inverter compressor	°C	<ul style="list-style-type: none"> <li>When the environment temperature is lower than 35°C, the temperature of the IPM module is lower than 80°C. The highest temperature is not higher than 95°C.</li> </ul>
10			Driver bus line voltage of inverter compressor	V	<ul style="list-style-type: none"> <li>The normal bus line voltage is 1.414 times larger than the power voltage. For example, if the three-phase power voltage is 390 V, the bus line voltage after current rectification is <math>390\text{ V} \times 1.414 = 551\text{ V}</math>. It is normal if the difference between the actual test value and the calculation value is</li> </ul>

GMV5 DC INVERTER VRF UNITS SERVICE MANUAL

					within 15 V.
11			Operation frequency of fan	Hz	●With the adjustment of system pressure, the fans run between 0 and 65 Hz.
12		Indoor unit parameter	Environment temperature of IDU	°C	—
13			Inlet-tube temperature of indoor heat exchanger	°C	●As the environment temperature is different, the inlet-tube temperature is 1-7°C lower than the outlet-tube temperature of the same IDU in cooling mode.
14			Outlet-tube temperature of indoor heat exchanger	°C	●The inlet-tube temperature is 10-20°C lower than the outlet-tube temperature of the same IDU in heating mode.
15			Opening degree of indoor electronic expansion valves	PLS	The opening degree automatically changes between 0 and 2000 PLS or between 0 and 480 PLS.
16	Communication parameter	Communication data		—	●The commissioning software shows that the number of IDUs/ODUs is consistent with the actual engineering quantity, without communication failure.
17	Drainage system	—		—	●The drainage effect of IDU is smooth and thorough, and no adverse-slope water storage exists in condensing drainage pipes. The ODU can implement drainage completely from the drainage pipe, without drops from the unit foundation.
18	Other	—			●No exceptional sound occurs on compressors and indoor/outdoor fans. No fault occurs on the unit operation.

# Chapter 4 Maintenance

## 1 Failure Code Table

### Indoor:

Error Code	Content	Error Code	Content
L0	Malfunction of IDU	d2	Malfunction of lower water temperature sensor of water tank
L1	Protection of indoor fan	d3	Malfunction of ambient temperature sensor
L2	Auxiliary heating protection	d4	Malfunction of entry-tube temperature sensor
L3	Water-full protection	d6	Malfunction of exit-tube temperature sensor
L4	Abnormal power supply for wired controller	d7	Malfunction of humidity sensor
L5	Freeze prevention protection	d8	Malfunction of water temperature sensor
L7	No main IDU	d9	Malfunction of jumper cap
L8	Power supply is insufficient	dA	Web address of IDU is abnormal
L9	For single control over multiple units, number of IDU is inconsistent	dH	PCB of wired controller is abnormal
LA	For single control over multiple units, IDU series is inconsistent	dC	Setting capacity of DIP switch code is abnormal
LH	Alarm due to bad air quality	dL	Malfunction of air outlet temperature sensor
LC	IDU is not matching with outdoor unit	dE	Malfunction of indoor CO <sub>2</sub> sensor
LL	Malfunction of water flow switch	dF	Malfunction of upper water temperature sensor of water tank
LE	Rotation speed of EC DC water pump is abnormal	dJ	Malfunction of backwater temperature sensor
LF	Malfunction of shunt valve setting	dP	Malfunction of inlet tube temperature sensor of generator
LJ	Setting of functional DIP switch code is wrong	dU	Malfunction of drainage pipe temperature sensor of generator
LP	Zero-crossing malfunction of PG motor	db	Debugging status
LU	Indoor unit's branch is not inconsistent for one-to-more unit of heat recovery system	dd	Malfunction of solar power temperature sensor
d1	Indoor PCB is poor	dn	Malfunction of swing parts

### Outdoor:

Error Code	Content	Error Code	Content
E0	Malfunction of ODU	FH	Current sensor of compressor 1 is abnormal
E1	High-pressure protection	FC	Current sensor of compressor 2 is abnormal
E2	Discharge low-temperature protection	FL	Current sensor of compressor 3 is abnormal
E3	Low-pressure protection	FE	Current sensor of compressor 4 is abnormal



GMV5 DC INVERTER VRF UNITS SERVICE MANUAL

E4	High discharge temperature protection of compressor	FF	Current sensor of compressor 5 is abnormal
J0	Protection for other modules	FJ	Current sensor of compressor 6 is abnormal
J1	Over-current protection of compressor 1	FP	Malfunction of DC motor
J2	Over-current protection of compressor 2	FU	Malfunction of casing top temperature sensor of compressor 1
J3	Over-current protection of compressor 3	Fb	Malfunction of casing top temperature sensor of compressor 2
J4	Over-current protection of compressor 4	Fd	Malfunction of exit tube temperature sensor of mode exchanger
J5	Over-current protection of compressor 5	Fn	Malfunction of inlet tube temperature sensor of mode exchanger
J6	Over-current protection for compressor 6	b1	Malfunction of outdoor ambient temperature sensor
J7	Gas-mixing protection of 4-way valve	b2	Malfunction of defrosting temperature sensor 1
J8	High pressure ratio protection of system	b3	Malfunction of defrosting temperature sensor 2
J9	Low pressure ratio protection of system	b4	Malfunction of liquid temperature sensor of sub-cooler
JA	Protection because of abnormal pressure	b5	Malfunction of gas temperature sensor of sub-cooler
JC	Water flow switch protection	b6	Malfunction of inlet tube temperature sensor of vapor liquid separator
JL	Protection because high pressure is too low	b7	Malfunction of exit tube temperature sensor of vapor liquid separator
JE	Oil-return pipe is blocked	b8	Malfunction of outdoor humidity sensor
JF	Oil-return pipe is leaking	b9	Malfunction of gas temperature sensor of heat exchanger
P0	malfunction of driving board of compressor	bA	Malfunction of oil-return temperature sensor 1
P1	Driving board of compressor operates abnormally	bH	Clock of system is abnormal
P2	Voltage protection of driving board power of compressor	bE	Malfunction of inlet tube temperature sensor of condenser
P3	Reset protection of driving module of compressor	bF	Malfunction of outlet tube temperature sensor of condenser
P4	Drive PFC protection of compressor	bJ	High-pressure sensor and low-pressure sensor are connected reversely
P5	Over-current protection of inverter compressor	bP	Malfunction of temperature sensor of oil-return 2
P6	Drive IPM module protection of compressor	bU	Malfunction of temperature sensor of oil return 3
P7	Malfunction of drive temperature sensor of compressor	bb	Malfunction of temperature sensor of oil return 4

**GMV5 DC INVERTER VRF UNITS SERVICE MANUAL**

P8	Drive IPM high temperature protection of compressor	H0	Malfunction of driving board of fan
P9	Desynchronizing protection of inverter compressor	H1	Driving board of fan operates abnormally
PA	Malfunction of drive storage chip of compressor	H2	Voltage protection of driving board power of fan
PH	High-voltage protection of compressor's drive DC bus bar	H3	Reset protection of driving module of fan
PC	Malfunction of current detection circuit drive of compressor	H4	Drive PFC protection of fan
PL	Low voltage protection for DC bus bar of drive of compressor	H5	Over-current protection of inverter fan
PE	Phase-lacking of inverter compressor	H6	Drive IPM module protection of fan
PF	Malfunction of charging loop of driven of compressor	H7	Malfunction of drive temperature sensor of fan
PJ	Failure startup of inverter compressor	H8	Drive IPM high temperature protection of fan
PP	AC current protection of inverter compressor	H9	Desynchronizing protection of inverter fan
PU	AC input voltage of drive of inverter compressor	HA	Malfunction of drive storage chip of inverter outdoor fan
F0	Main board of ODU is poor	HH	High-voltage protection of fan's drive DC bus bar
F1	Malfunction of high-pressure sensor	HC	Malfunction of current detection circuit of fan drive
F3	Malfunction of low-pressure sensor	HL	Low voltage protection of bus bar of fan drive
F5	Malfunction of discharge temperature sensor of compressor 1	HE	Phase-lacking of inverter fan
F6	Malfunction of discharge temperature sensor of compressor 2	HF	Malfunction of charging loop of fan drive
F7	Malfunction of discharge temperature sensor of compressor 3	HJ	Failure startup of inverter fan
F8	Malfunction of discharge temperature sensor of compressor 4	HP	AC current protection of inverter fan
F9	Malfunction of discharge temperature sensor of compressor 5	HU	AC input voltage of drive of inverter fan
FA	Malfunction of discharge temperature sensor of compressor 6		

**Debugging:**

Error Code	Content	Error Code	Content
U0	Preheat time of compressor is insufficient	C6	Alarm because ODU quantity is inconsistent
U2	Wrong setting of ODU's capacity code/jumper cap	C7	Abnormal communication of converter
U3	Power supply phase sequence protection	C8	Emergency status of compressor
U4	Refrigerant-lacking protection	C9	Emergency status of fan
U5	Wrong address for driving board of compressor	CA	Emergency status of module
U6	Alarm because valve is abnormal	CH	Rated capacity is too high
U8	Malfunction of pipeline for IDU	CC	No main unit

**GMV5 DC INVERTER VRF UNITS SERVICE MANUAL**

U9	Malfunction of pipeline for ODU	CL	The matching ratio of rated capacity for IDU and ODU is too low
UC	Setting of main IDU is succeeded	CE	Communication malfunction between mode exchanger and IDU
UL	Emergency operation DIP switch code of compressor is wrong	CF	Malfunction of multiple main control units
UE	Charging of refrigerant is invalid	CJ	Address DIP switch code of system is shocking
UF	Identification malfunction of IDU of mode exchanger	CP	Malfunction of multiple wired controller
C0	Communication malfunction between IDU, ODU and IDU's wired controller	CU	Communication malfunction between IDU and the receiving lamp
C2	Communication malfunction between main control and inverter compressor driver	Cb	Overflow distribution of IP address
C3	Communication malfunction between main control and inverter fan driver	Cd	Communication malfunction between mode exchanger and ODU
C4	Malfunction of lack of IDU	Cn	Malfunction of network for IDU and ODU of mode exchanger
C5	Alarm because project code of IDU is inconsistent	Cy	Communication malfunction of mode exchanger

**Status:**

Error Code	Content	Error Code	Content
A0	Unit waiting for debugging	Ay	Shielding status
A2	Refrigerant recovery operation of after-sales	n0	SE operation setting of system
A3	Defrosting	n3	Compulsory defrosting
A4	Oil-return	n4	Limit setting for max. capacity/output capacity
A6	Heat pump function setting	n5	Compulsory excursion of engineering code of IDU
A7	Quiet mode setting	n6	Inquiry of malfunction
A8	Vacuum pump mode	n7	Inquiry of parameters
AH	Heating	n8	Inquiry of project code of IDU
AC	Cooling	n9	Check quantity of IDU on line
AL	Charge refrigerant automatically	nA	Heat pump unit
AE	Charge refrigerant manually	nH	Heating only unit
AF	Fan	nC	Cooling only unit
AJ	Cleaning reminding of filter	nE	Negative code
AP	Debugging confirmation when starting up the unit	nF	Fan model
AU	Long-distance emergency stop	nJ	High temperature prevention when heating
Ab	Emergency stop of operation	nU	Eliminate the long-distance shielding command of IDU
Ad	Limit operation	nb	Bar code inquiry
An	Child lock status	nn	Length modification of connection pipe of ODU

Note: Previous faults in the system can be queried on the main board of the ODU and commissioning software. See n6 Fault Enquiry of the ODU or enquiry function of the commissioning software for the method.

## 2 Exception Analyzing and Troubleshooting

### 2.1 Form analyzing

#### 2.1.1 Control

Fault code	Fault	Possible reasons	Solution
F0	Faults in the ODU's main board (such as memory and address chip exceptions)	<ol style="list-style-type: none"> <li>1. The clock chip on the main board is damaged.</li> <li>2. The memory chip on the main board is damaged.</li> <li>3. The address chip on the main board is damaged.</li> </ol>	<ol style="list-style-type: none"> <li>1. Replace the small CPU board.</li> <li>2. Replace the control board.</li> <li>3. Replace the control board.</li> </ol>
FC	Faults in the constant frequency compressor's current sensor	<ol style="list-style-type: none"> <li>1. The constant-frequency compressor is not started.</li> <li>2. The current detection board is faulty.</li> <li>3. The main board's detection circuit is faulty.</li> </ol>	<ol style="list-style-type: none"> <li>1. If the compressor is not started, check if the AC contact is closed. If not, replace the AC contact.</li> </ol> <p>If the connection is loose, reconnect it;</p> <ol style="list-style-type: none"> <li>2. Replace the current detection board.</li> <li>3. Replace the main board.</li> </ol>
U2	Wrong outdoor capacity code setting	<ol style="list-style-type: none"> <li>1. The capacity code is wrong.</li> <li>2. The dial component is faulty.</li> </ol>	<ol style="list-style-type: none"> <li>1. Modify the capacity code setting.</li> <li>2. Replace the main board.</li> </ol>
U3	Power phase sequence protection	<ol style="list-style-type: none"> <li>1. The three-phase power cable is not connected correctly.</li> <li>2. The main board's detection circuit is faulty.</li> </ol>	<ol style="list-style-type: none"> <li>1. Check connection of the power cable.</li> <li>2. Replace the control board.</li> </ol>
UL	Wrong emergency operation dial code	<ol style="list-style-type: none"> <li>1. The dial setting is wrong.</li> <li>2. The dial component is faulty.</li> </ol>	<ol style="list-style-type: none"> <li>1. Modify the dial setting.</li> <li>2. Replace the main board.</li> </ol>
C0	Communication failure between indoor and ODUs and IDU's communicator	<ol style="list-style-type: none"> <li>1. The communication cable is not connected.</li> <li>2. The communicator is disconnected.</li> <li>3. The communication cable is poorly connected.</li> <li>4. The communicator controller is faulty.</li> </ol>	<p>If C0 is not displayed on the control board of the ODU, check the network between the IDU and communicator. If C0 is displayed, check the network between the IDUs and ODUs and between the IDU and communicator as follows:</p> <ol style="list-style-type: none"> <li>1) Check if the cables connecting the control board of the ODU and the IDU and connecting the IDU and communicator are loose. If yes, reconnect them;</li> <li>2) Check if the cables connecting the control board and IDU and connecting the IDU and communicator are broken. If yes, replace the cables;</li> <li>3) Check the contact of the communication cables;</li> <li>4) Replace the control board. If the fault is solved, the control board is faulty. Replace the IDU. If the fault is solved, the IDU is faulty.</li> </ol>
C2	Communication failure between main control board and inverter compressor drive	<ol style="list-style-type: none"> <li>1. The communication cable is not connected.</li> <li>2. The communicator is disconnected.</li> <li>3. The communication cable is poorly connected.</li> <li>4. The communicator is faulty.</li> </ol>	<ol style="list-style-type: none"> <li>1) Check if the cable connecting the control board and the compressor's drive board is loose. If yes, reconnect it;</li> <li>2) Check if the cable connecting the control board and compressor's drive board is broken. If yes, replace the cable;</li> <li>3) Check the contact of the communication cable connecting the control board and compressor's drive board;</li> <li>4) Replace the control board. If the fault is solved, the control board is faulty. Replace the compressor's drive board. If the fault is solved, the compressor's drive board is faulty.</li> </ol>

GMV5 DC INVERTER VRF UNITS SERVICE MANUAL

C3	Communication failure between main control board and variable frequency fan drive	<ol style="list-style-type: none"> <li>1. The communication cable is not connected.</li> <li>2. The communicator is disconnected.</li> <li>3. The communication cable is poorly connected.</li> <li>4. The communicator is faulty.</li> </ol>	<ol style="list-style-type: none"> <li>1) Check if the cable connecting the fan's drive board and the compressor's drive board is loose. If yes, reconnect it;</li> <li>2) Check if the cable connecting the fan's drive board and compressor's drive board is broken. If yes, replace the cable;</li> <li>3) Check the contact of the communication cable connecting the fan's drive board and compressor's drive board;</li> <li>4) Replace the control board. If the fault is solved, the control board is faulty. Replace the fan's drive board. If the fault is solved, the fan's drive board is faulty.</li> </ol>
C4	Malfunction of lack of indoor unit	<ol style="list-style-type: none"> <li>1. Some indoor units in the system are not power-connected.</li> <li>2. Communication wires of some indoor units in the system are disconnected or have loose contact.</li> <li>3. Controllers of some indoor units in the system are abnormal.</li> </ol>	<ol style="list-style-type: none"> <li>1. Check the number of online indoor units through outdoor unit and compare it with the number of indoor units that are actually installed. Confirm the number of missing indoor units.</li> <li>2. Check whether all the indoor units are power-connected. If some are not, connect them to power. If power connection is fine, check further whether there is any indoor unit that fails to display on wired controller or receiver board. If such indoor unit exists, it means its main board is abnormal and needs to be replaced. If everything said above is confirmed OK, continue to check according to step 3.</li> <li>3. The missing indoor units will display error "C0" on wired controller or receiver board. Check the communication wire of the missing indoor unit whether it is disconnected or has loose contact. If yes, connect the communication wire tightly. If communication wire is OK, check whether it is connected reversely. Power on the indoor unit again and see if error "C0" occurs. If "C0" is displayed, it means main board is abnormal and needs to be replaced.</li> </ol>
C5	Indoor unit project number conflict warning	<ol style="list-style-type: none"> <li>1. Project numbers conflict with each other.</li> </ol>	<ol style="list-style-type: none"> <li>1. Change conflicting project numbers and ensure that no IDU's project number is repeated.</li> </ol>
C6	Outdoor unit number inconsistency warning	<ol style="list-style-type: none"> <li>1. Communication cables between ODUs are loose.</li> <li>2. Communication cables between ODUs are broken.</li> <li>3. Communication cables between ODUs are poorly connected.</li> <li>4. The control board is faulty.</li> </ol>	<ol style="list-style-type: none"> <li>1. If the communication cable is loose, reconnect it;</li> <li>2. If the communication cable is broken, replace it;</li> <li>3. Check contact of the communication cable;</li> <li>4. Replace the control board.</li> </ol>
CC	No controlling unit	<ol style="list-style-type: none"> <li>1. The SA8 dial switch of the ODU is not switched to 00.</li> <li>2. The SA8 dial switch of the ODU is faulty.</li> </ol>	<ol style="list-style-type: none"> <li>1. Switch the SA8 dial switch of an ODU to 00;</li> <li>2. Replace the control board or switch an ODU's SA8 dial switch to 00.</li> </ol>
CF	Multiple controlling units	<ol style="list-style-type: none"> <li>1. SA8 dial switches of multiple ODUs are switched to 00.</li> <li>2. Dial switches of multiple ODUs are faulty.</li> </ol>	<ol style="list-style-type: none"> <li>1. Leave one SA8 dial switch unchanged, while switch all the other dial switches to 11;</li> <li>2. Replace the control board.</li> </ol>
L7	No master IDU	<ol style="list-style-type: none"> <li>1. The master IDU is powered off.</li> <li>2. The communication of the master IDU fails.</li> <li>3. The main board of the master IDU is faulty.</li> <li>4. No master IDU is set in the system.</li> </ol>	<ol style="list-style-type: none"> <li>1. Check if the master IDU is powered on. If yes, replace the main board;</li> <li>2. Check the contact of the communication cable of the master IDU. If no communication failure (C0) is reported, replace the main board.</li> <li>3. Replace the IDU's main board and reset the master IDU.</li> <li>4. Set the master IDU.</li> </ol>

Note: Solution of C5 fault when multiple cooling systems are controlled in a centralized way  
 When multiple cooling systems are controlled in a centralized way, the C5 fault, i.e. project

number conflict, may occur on different cooling systems. In such case, set project numbers of each system and solve the fault as follows:

1) Project number conflict:

When multiple systems are controlled in a centralized way, if two or more IDUs share the same project number, the engineer number conflict occurs. In that case, IDUs cannot be switched to varied modes or be turned on or off. The whole device cannot be started before the conflict is solved. The commissioning software will show the following Figure1:

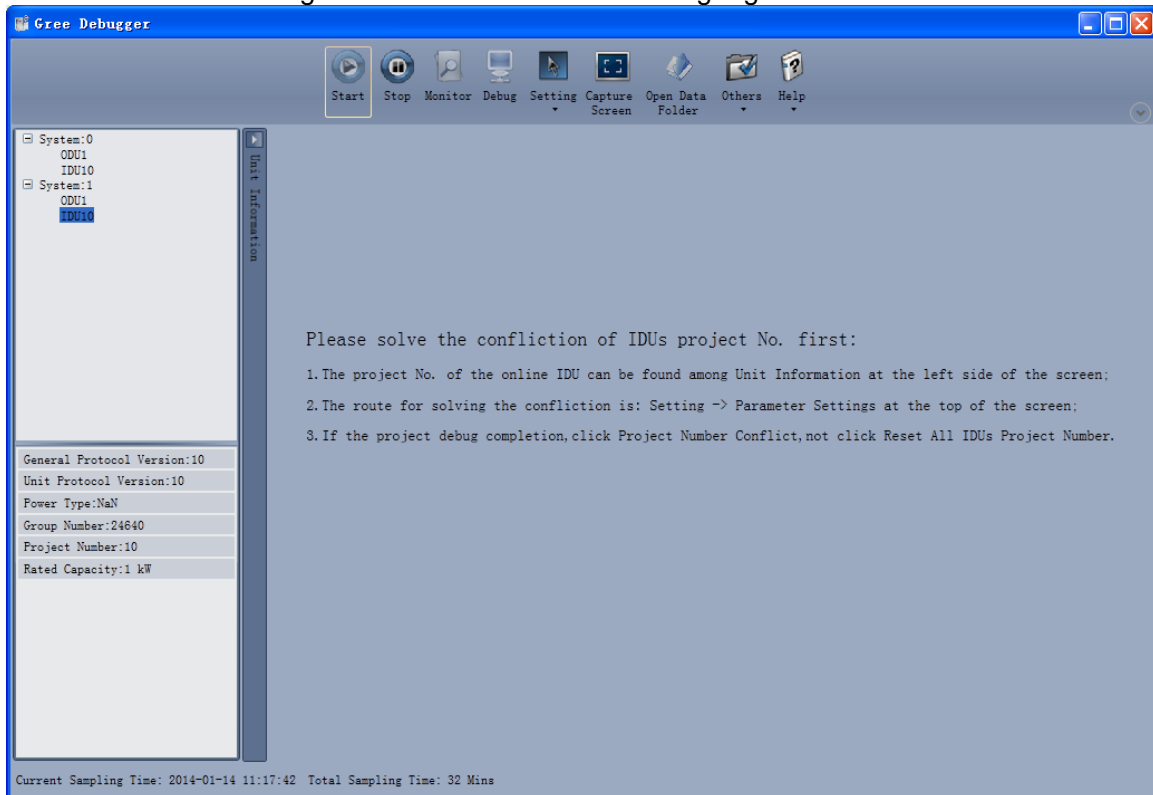

Figure 1

2) Solution of project number conflict:

① Manual setting on the commissioning software:

Use the commissioning software to set IDUs' project numbers separately in every system or reset projects numbers in multiple systems.

Choose Setting -> Parameter Settings, as shown in Figure 2:

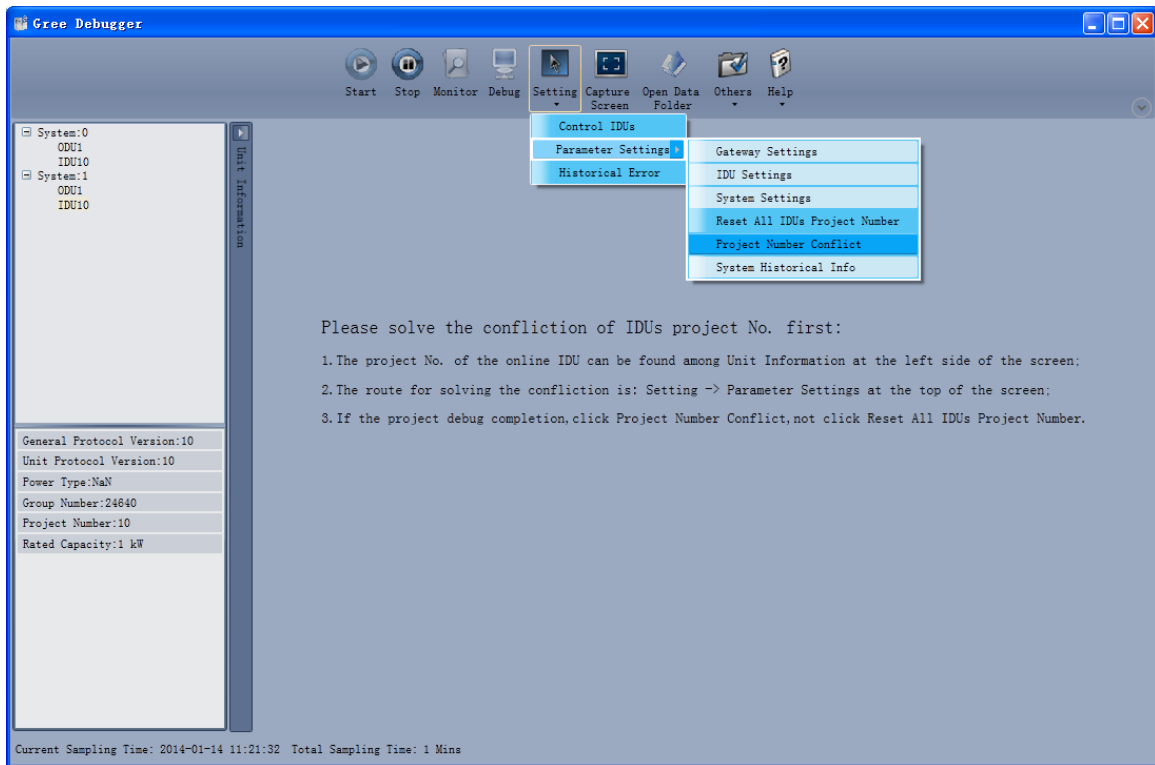

Figure 2

If project commissioning is finished and the IDU where the conflict occurs needs to be set separately. Click Project Number Conflict, as shown in Figure 3. The pop-up box comprises two parts: conflicting IDU box, showing the IDU's project number, system number and time; setting box, showing the IDU project number setting and setting button.

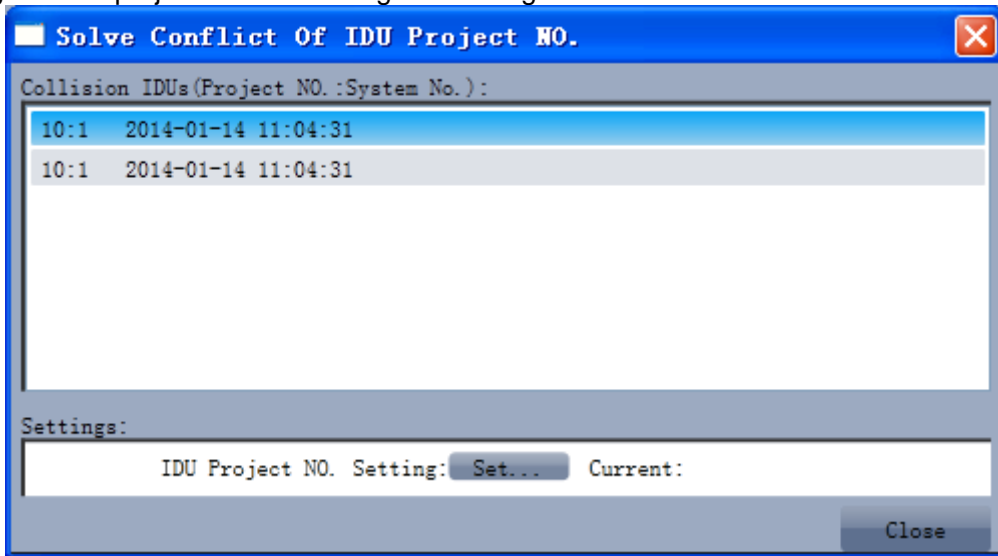

Figure 3

Choose one IDU in the conflicting IDU box shown in Figure 3 and click Set in the setting box. Choose a value in the pop-up box shown in Figure 4 and click Set.

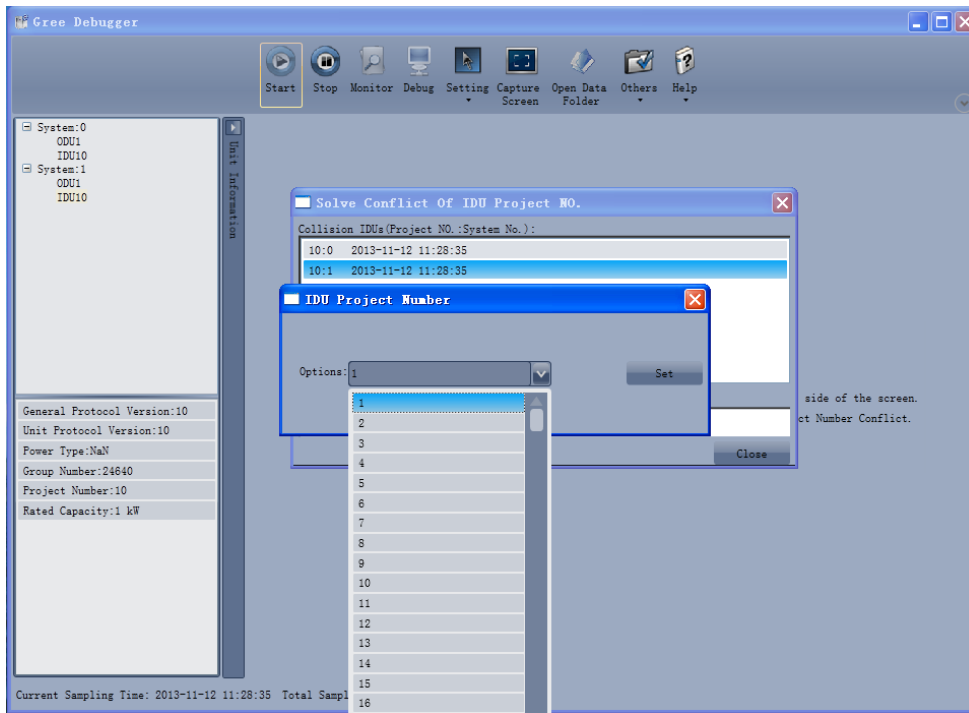

Figure 4

If the conflict is solved, the system will return to the normal status and IDUs can be operated, as shown in Figure 5:

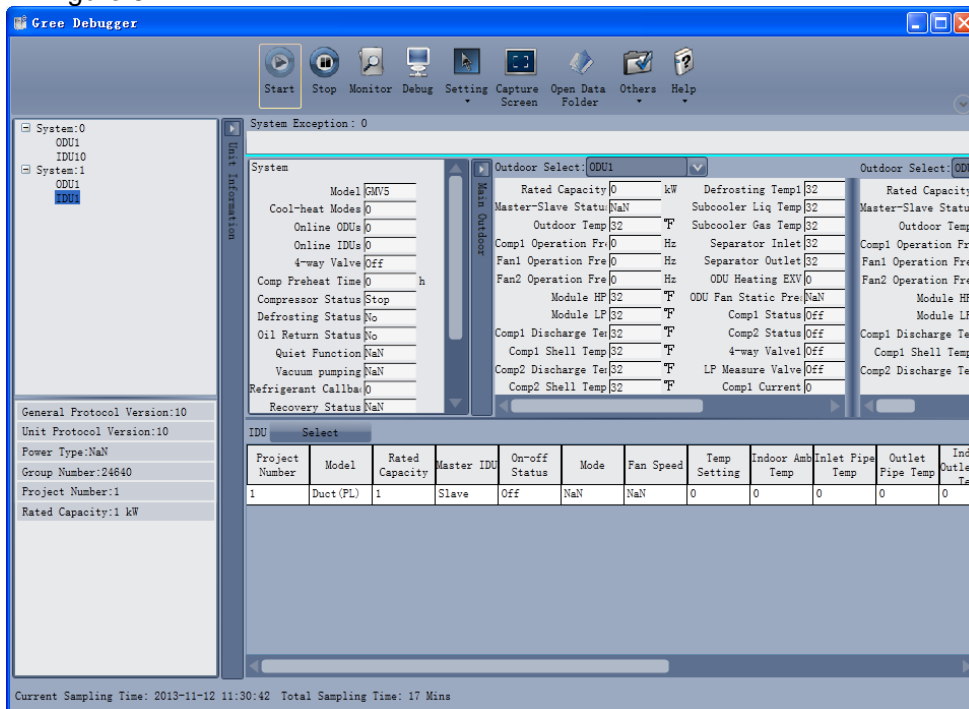

Figure 5

If project commissioning is not finished and all the IDUs' project numbers need to be reset, click Set All IDUs Project Number shown in Figure 2. As shown in Figure 6, the pop-up box comprises two parts: Systems Selection, where you can choose the system to be reset; Settings box, where you can give the resetting instruction.



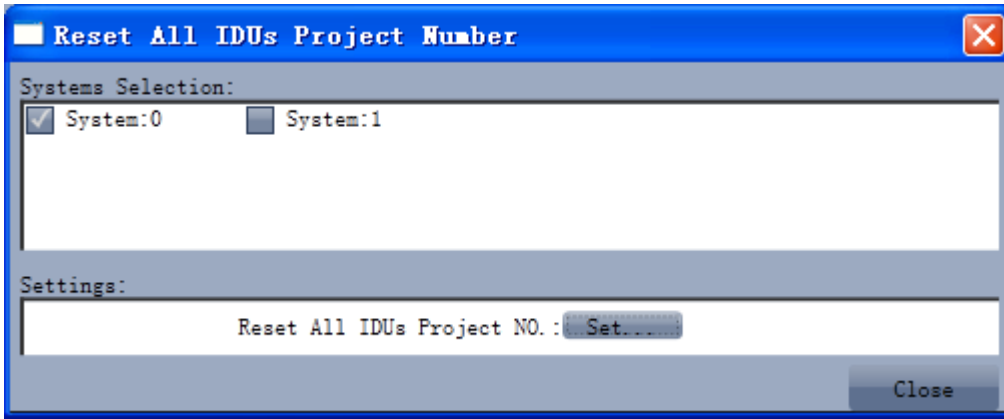

Figure 6

Choose one or multiple systems in the Systems Selection box and click Set in the Settings box, as shown in Figure 6. Click Set, as shown in Figure 7.

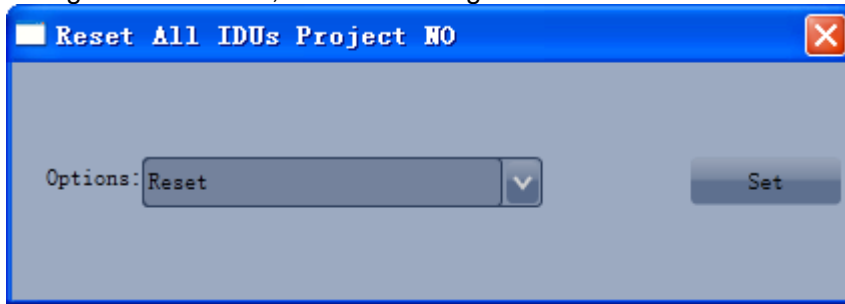

Figure 7

If the conflict is solved, the system will return to the normal status and IDUs can be operated as shown in Figure 5.

② Manual setting on the communicator and remote controller:

When the project number conflict occurs, you can use the communicator or remote controller to revise project numbers and solve the conflict. See the manual of the communicator or remote controller for the method.

③ Setting of auto project number deviation on ODU's main board (recommended)

You can set auto IDU project number deviation via the ODU's main board as follows:

(1) After the whole system is commissioned, short press SW3 on the controlling unit and the system will enter the standby status as follows:

LED1		LED2		LED3	
Function Code	LED Status	Progress	LED Status	Status	LED Status
A7	Flicker	00	Flicker	00	Flicker
A6	Flicker	00	Flicker	00	Flicker
A2	Flicker	00	Flicker	00	Flicker
A8	Flicker	00	Flicker	00	Flicker
n0	Flicker	01	Flicker	00	Flicker
n1	Flicker	00	Flicker	00	Flicker
n2	Flicker	00	Flicker	00	Flicker
n3	Flicker	00	Flicker	00	Flicker
n4	Flicker	00	Flicker	00	Flicker
n5	Flicker	00	Flicker	00	Flicker

(2) Press SW2 (▼) on the controlling unit and select n5. Short press SW7 to show the following information:

LED1		LED2		LED3	
Function Code	LED Status	Progress	LED Status	Status	LED Status
n5	Solid On	00	Flicker	OC	Flicker

(3) When project number deviation is to be confirmed, short press SW7 confirmation button to enter the project number deviation status as shown in the following:

LED1		LED2		LED3	
Function Code	LED Status	Current Progress/Mode	LED Status	Status	LED Status
n5	Solid On	00	Solid On	OC	Solid On

· IDU project numbers in all systems will automatically deviate. The conflict will be solved in about 1 minute and the system will work properly.

The automatic deviation function only works when it is enabled on the controlling unit in the system, of which the centralized control address is 00000.

Note: When there are only a few conflicting IDUs, manual setting is recommended. This method only applies to conflicting IDUs and does only affect other IDUs' project numbers.

In case of many conflicting IDUs, auto deviation is recommended. This method is faster, but may change project numbers of normal IDUs. This method applies for the first commissioning after installation.

Fault code	Fault	Possible reasons	Solution
C2	Communication failure between main control board and inverter compressor drive	1. The control board is powered off; 2. The compressor drive board is powered off; 3. The communication cable between the control board and compressor drive board is not connected; 4. The compressor drive board's dial switch SA201 is wrong.	1. Check the power supply of the control board. Replace the control board if it works properly; 2. Check the power supply of the drive board. Replace the drive board if it works properly; 3. Connect the main board and drive board using the communication cable; 4. Adjust the dial switch of the compressor drive board.
P3	Compressor drive module reset protection	1. The compressor drive board is faulty.	1. Replace the compressor drive board.
P5	Inverter compressor over-current protection	1. The drive board's IPM module is damaged; 2. The compressor's UVW cable is not connected properly; 3. The compressor is damaged.	1. Replace the compressor drive board; 2. Reconnect the compressor's UVW cable; 3. Replace the compressor.
P6	Compressor drive IPM module protection	1. The drive board's IPM module is damaged; 2. The compressor's UVW cable is not connected properly; 3. The compressor is damaged.	1. Replace the compressor drive board; 2. Reconnect the compressor's UVW cable; 3. Replace the compressor.
P7	Compressor drive temperature sensor fault	1. The compressor drive board is faulty.	1. Replace the compressor drive board.
P8	Compressor drive IPM over-temperature protection	1. The compressor drive board is faulty; 2. Thermal gel is not applied evenly on the IPM module; 3. The IPM module is not screwed properly.	1. Replace the compressor drive board; 2. Apply thermal gel evenly on the IPM module; 3. Screw the IPM module properly.
P9	Inverter compressor out-of-step protection	1. The compressor drive board is faulty. 2. The compressor is damaged.	1. Replace the compressor drive board. 2. Replace the compressor.
PH	Compressor drive DC bus high voltage protection	1. Does the voltage of the input power cable of the whole system exceed 460 V; 2. The compressor drive board is faulty.	1. Lower the voltage of the input power cable to the required range; 2. Replace the compressor drive board.
PL	Compressor drive DC bus low voltage protection	1. Is the voltage of the input power cable of the whole system lower than 320 V; 2. The compressor drive board is	1. Elevate the voltage of the input power cable to the required range; 2. Replace the compressor drive board.

**GMV5 DC INVERTER VRF UNITS SERVICE MANUAL**

		faulty.	
PC	Compressor drive current check circuit fault	1. The compressor drive board is faulty.	1. Replace the compressor drive board.
PF	Compressor drive recharging circuit fault	1. Is the voltage of the input power cable of the whole system lower than 280 V; 2. The compressor drive board is faulty.	1. Elevate the voltage of the input power cable to the required range; 2. Replace the compressor drive board.
PJ	Inverter compressor starting failure	1. The drive board is damaged; 2. The compressor's UVW cable is not connected properly; 3. The compressor is damaged.	1. Replace the compressor drive board; 2. Reconnect the compressor's UVW cable; 3. Replace the compressor.
C3	Communication failure between main control board and variable frequency fan drive	1. The control board is powered off; 2. The fan drive board is powered off; 3. The communication cable between the control board and fan drive board is not connected; 4. The fan drive board's dial switch is wrong.	1. Check the power supply of the control board. Replace the control board if it works properly; 2. Check the power supply of the drive board. Replace the drive board if it works properly; 3. Connect the main board and drive board using the communication cable; 4. Adjust the dial switch of the fan drive board.
H3	Fan drive module reset protection	1. The fan drive board is faulty.	1. Replace the fan drive board.
H5	Variable frequency fan over-current protection	1. The fan drive board's IPM module is damaged; 2. The fan's UVW cable is not connected properly; 3. The fan is damaged.	1. Replace the fan drive board; 2. Reconnect the fan's UVW cable; 3. Replace the fan.
H6	Fan drive IPM module protection	1. The fan drive board's IPM module is damaged; 2. The fan's UVW cable is not connected properly; 3. The fan is damaged.	1. Replace the fan drive board; 2. Reconnect the fan's UVW cable; 3. Replace the fan.
H7	Fan drive temperature sensor fault	1. The fan drive board is faulty.	1. Replace the fan drive board.
H8	Fan drive IPM over-temperature protection	1. The fan drive board is faulty; 2. Thermal gel is not applied evenly on the IPM module; 3. The IPM module is not screwed properly.	1. Replace the fan drive board; 2. Apply thermal gel evenly on the IPM module; 3. Screw the IPM module properly.
H9	Variable frequency fan out-of-step protection	1. The fan drive board is faulty. 2. The fan is damaged.	1. Replace the fan drive board. 2. Replace the fan.
HH	Fan drive DC bus high voltage protection	1. Does the voltage of the input power cable of the whole system exceed 460 V; 2. The fan drive board is faulty.	1. Lower the voltage of the input power cable to the required range; 2. Replace the fan drive board.
HL	Fan drive DC bus low voltage protection	1. Is the voltage of the input power cable of the whole system lower than 320 V; 2. Is the fan drive board well connected with the compressor drive board; 3. The fan drive board is faulty.	1. Elevate the voltage of the input power cable to the required range; 2. Connect the fan drive board with the compressor drive board according to the wiring diagram; 3. Replace the fan drive board.
HC	Fan drive current detection circuit fault	1. The fan drive board is faulty.	1. Replace the fan drive board.
HJ	Variable frequency fan starting failure	1. The drive board is damaged; 2. The fan's UVW cable is not connected properly; 3. The fan is damaged.	1. Replace the fan drive board; 2. Reconnect the fan's UVW cable; 3. Replace the fan.

**2.1.2 System faults**

2.1.2.1 System exhaust temperature exception

Fault code	Fault	Possible reasons						Solution
		Primary reason		Secondary reason		Tertiary reason		
		Description	Confirmation method	Description	Confirmation method	Description	Confirmation method	
E4	High exhaust temperature protection	1. The stop valve of the ODU is not fully opened as required.	—	—	—	—	Manual check	Fully open the stop valve.
		2. The IDU's electronic expansion valve is not working properly.	When the IDU is working in the cooling mode and the electronic expansion valve is opened to 2000PLS, the exhaust temperature of the IDU's coil is more than 15°C higher than the intake temperature; when the IDU is working in the heating mode and the electronic expansion valve is opened to 2000PLS, the intake temperature of the IDU's coil is more than 10°C higher than the intake temperature;	2.1 The controlling of electronic expansion valve by main board of indoor unit is abnormal.	Reset the IDU. Listen to the sound and touch the tube to see if the electronic expansion valve is reset. If it is set, it is normal. Otherwise, it is faulty.	2.1.1 The control wire of the electronic expansion valve is not connected to the main board.	Manual check	Connect the electronic expansion valve's control wire to the main board.
						2.1.2 The control wire that connects the electronic expansion valve to the main board is broken.	Manual check	Repair or replace the control wire of the electronic expansion valve.
				2.2 The electronic expansion valve in the mode switcher is faulty.	Other reasons	2.2.1 Affected by impurities in the system	—	Clean the system and clear the impurities. Replace the body of the electronic expansion valve.
						2.2.2 The valve body is faulty.	—	Replace the body of the electronic expansion valve.
		3. The system pipeline is blocked.	The system's exhaust temperature rises and the low pressure is too low (compared with the reference value).	3.1 The fluid pipe is blocked.	Touch the pipe along the flowing direction of refrigerant to feel the temperature difference.	—	—	Replace and solder the pipe.
				3.2 The air pipe is blocked.	The difference is large or part of the pipe is frosting.	—	—	Replace and solder the pipe.

				3.3 The pipe that connects the IDU is blocked.	Touch the pipe along the flowing direction of refrigerant to feel the temperature difference. The difference is large or part of the pipe is frosting.	3.3.1 The block is caused by solder.	Cut off the pipe to see if it is blocked.	Replace and solder the pipe.
						3.3.2 The pipeline is blocked by impurities.		Replace and solder the pipe.
		4. Lacking refrigerant	The system's exhaust temperature rises and the low pressure is too low (compared with the reference value).	4.1 Not enough refrigerant	—	—	—	Inject refrigerant as required.
				4.2 Refrigerant pipe leakage	Use the refrigerant leak detector to detect the leak along the pipe.	—	—	Stop the leak. Pump out air and inject refrigerant again.
		5. Wrong refrigerant is injected.	Stop the whole system. Test the system's balance pressure 20 minutes later and convert the pressure into the corresponding saturation temperature. Compare it with the outdoor ambient temperature. If the difference is larger than 5°C, it is exceptional.	—	—	—	—	Discharge existing refrigerant and inject the correct refrigerant as required.
		6. Exhaust temperature sensor failure	—	—	—	—	—	Replace the temperature sensor or main board.
		7. The ambient temperature exceeds the scope of temperature required for safe operation.	—	The outdoor ambient temperature exceeds 50°C.	Measure the ambient temperature.	—	—	It is a normal phenomenon caused by the protection function.
E2	Low exhaust temperature protection	1. The ODU's electronic expansion valve is not working properly.	When the system is working in the heating mode and the ODU's	1.2 The controlling heating electronic expansion of the main board or	Reset the ODU. Listen to the sound and touch the tube to see if the electronic expansion	1.2.1 The control wire of the electronic expansion valve is not connected	Manual check	Connect the electronic expansion valve's control wire to the main board.

		electronic expansion valve is opened to 100PLS, the intake temperature of the corresponding liquid-air separator is more than 1°C lower than the low-pressure saturation temperature and the difference between the compressor's exhaust temperature or cover temperature and the high-pressure temperature is smaller than 10°C.	the electronic expansion valve of the subcooler is faulty.	valve is reset. If it is set, it is normal. Otherwise, it is faulty.	to the main board.		
			1.3 The body of the electronic expansion valve is not working properly.	Other reasons	1.2.2 The control wire that connects the electronic expansion valve to the main board is broken.	Manual check	Repair or replace the control wire of the electronic expansion valve.
					1.3.1 Affected by impurities in the system	—	Clean the system and clear the impurities. Replace the body of the electronic expansion valve.
					1.3.2 The body of the valve is faulty.	—	Replace the body of the electronic expansion valve.
	2. The IDU's electronic expansion valve is not working properly	When the system is working in the cooling mode and the ODU's electronic expansion valve is opened to 200PLS, the exhaust temperature of the IDU's coil is more than 1°C lower than the intake pipe's temperature and the difference between the compressor's exhaust temperature or cover temperature and the high-pressure temperature is smaller than 10°C.	2.1 The controlling of electronic expansion valve by main board of indoor unit is abnormal.	Reset the IDU. Listen to the sound and touch the tube to see if the electronic expansion valve is reset. If it is set, it is normal. Otherwise, it is faulty.	2.1.1 The control wire of the electronic expansion valve is not connected to the main board.	Manual check	Connect the electronic expansion valve's control wire to the main board.
2.1.2 The control wire that connecting the electronic expansion valve to the main board is broken.					Manual check	Repair or replace the control wire of the electronic expansion valve.	
2.2 The body of the electronic expansion valve is not working properly.			Other reasons	2.2.1 Affected by impurities in the system	—	Clean the system and clear the impurities. Replace the body of the electronic expansion valve.	
				2.2.2 The valve body is faulty.	—	Replace the body of the electronic expansion valve.	

		3. Exhaust temperature sensor failure	—	—	—	—	—	Replace the temperature sensor or main board.
		4. Too much refrigerant	Other reasons	Incorrect quantity of refrigerant is injected.	—	—	—	Check the necessary amount of refrigerant and discharge the unneeded refrigerant slowly via the stop valve of the fluid pipe.

2.1.2.2 Pressure exception

Fault code	Fault	Possible reasons						Solution
		Primary reason		Secondary reason		Tertiary reason		
		Description	Confirmation method	Description	Confirmation method	Description	Confirmation method	
E1	High pressure protection	1. The stop valve of the ODU is not fully opened as required.	—	—	—	—	Manual check	Fully open the stop valve.
		2. The system pipeline is blocked.	The system's exhaust pressure rises and the low pressure is too low (compared with the reference value).	2.1. The system air pipeline is blocked.	Touch the pipe along the flowing direction of refrigerant to feel the temperature difference. The difference is large.	2.1.1 The block is caused by solder. 2.1.2 The pipeline is blocked by impurities.	Cut off the pipe and check it.	Replace and solder the pipe. Replace and solder the pipe.
				2.2 The fluid pipe is blocked.	Touch the pipe along the flowing direction of refrigerant to feel the temperature difference. The difference is large or part of the pipe is frosting.	—	—	Replace and solder the pipe.
				2.4 The pipe that connects the IDU is blocked.	Touch the pipe along the flowing direction of refrigerant to feel the temperature difference. The difference is large or part of the pipe is frosting.	2.4.1 The block is caused by solder.	Cut off the pipe and check it.	Replace and solder the pipe.
						2.4.2 The pipeline is blocked by impurities.		Replace and solder the pipe.

			3.1 In the cooling mode, the outdoor temperature is over 50°C.	Measure the outdoor ambient temperature.	—	—	It is a normal phenomenon caused by the protection function.	
			3.2 In the heating mode, the actual ambient temperature of the IDU's return air is over 30°C.	Measure the temperature of the unit's return air.	—	—	It is a normal phenomenon caused by the protection function.	
		3. The ambient temperature is too high.	—					
		4. The pressure sensor is faulty.	—	4.1 The high pressure sensor is faulty.	Stop the whole system. Test the system's balance pressure 20 minutes later and convert the pressure into the corresponding saturation temperature. Compare it with the outdoor ambient temperature. If the difference is larger than 5°C, it is exceptional.	—	—	Replace the high pressure sensor.
				4.2 The high pressure and low pressure sensors are connected reversely.	Connect the stop valve of the module fluid pipe and air pipe to the high and low pressure gauges and transform the readings into corresponding temperatures. Compare them to the high- and low-temperatures tested by the system. If the difference is larger than 5°C, it is exceptional.	—	—	Reconnect the high- and low-pressure sensors.
		5. The high pressure switch is faulty.	E1 protection is displayed on the unit when it is	5.1 The high pressure switch is not	—	5.1.1 The pressure switch is not connected	—	Reconnect it.



			powered on.	connected to the main board.		to the main board.		
					—	5.1.2 The connect wire between the pressure switch and main board is faulty.	—	Reconnect them with the wire.
				5.2 The high pressure switch is damaged.	—	—	—	Replace the pressure switch.
		6. The fan is not working properly.	A. The ODU's fan does not work in the cooling mode. B. The IDU's motor does not work in the heating mode.	6.1 The IDU's fan is faulty.	Manual check	6.1.1 The power cable connecting the motor and main board is loose.	Manual check	Reconnect the motor with the power cable.
						6.1.2 The electric capacity is not connected or is damaged.	Manual check	Connect or replace the electric capacity.
						6.1.3 The motor is damaged.	Other reasons	Replace the motor.
				6.2 The ODU's fan is faulty.	Manual check	6.2.1 The fan motor is not properly connected with the control board of the motor with the power cable.	Manual check	Reconnect it properly.
						6.2.2 The fan motor is not properly connected with the control board of the motor with the signal feedback cable.	Manual check	Reconnect it properly.

						6.2.3 The control board of the fan's motor is damaged.	Manual check	Replace the control board of the motor.
						6.2.4 The main board of the fan's motor is damaged.	Other reasons	Replace the motor.
		7. Too much refrigerant	Other reasons	Incorrect quantity of refrigerant is injected.	—	—	—	Check the necessary amount of refrigerant and discharge unneeded refrigerant slowly via the stop valve of the fluid pipe.
JL	Low high pressure protection	1. The ambient temperature exceeds the range.	—	1.1 The outdoor ambient temperature in the cooling mode is lower than -10°C.	Measure the outdoor ambient temperature.	—	—	It is a normal phenomenon caused by the protection function.
				1.2 The indoor ambient temperature in the heating mode is lower than 5°C.	Measure the temperature of the unit's return air.	—	—	It is a normal phenomenon caused by the protection function.
		2. Not enough refrigerant	—					

Fault code	Fault	Possible reasons						Solution
		Primary reason		Secondary reason		Tertiary reason		
		Description	Confirmation method	Description	Confirmation method	Description	Confirmation method	
E3	Low-pressure Protection	1. The stop valve of the ODU is not fully opened as required.	—	—	—	—	Manual check	Fully open the stop valve.

		2. The system pipeline is blocked.	The system's exhaust pressure rises and the low pressure is too low (compared with the reference value).	2.1. The system air pipeline is blocked.	Touch the pipe along the flowing direction of refrigerant to feel the temperature difference. The difference is large.	2.1.1 The block is caused by solder.	Cut off the pipe and check it.	Replace and solder the pipe.
						2.1.2 The pipeline is blocked by impurities.		Replace and solder the pipe.
				2.2 The fluid pipe is blocked.	Touch the pipe along the flowing direction of refrigerant to feel the temperature difference. The difference is large or part of the pipe is frosting.	—	—	Replace and solder the pipe.
				2.4 The pipe that connects the IDU is blocked.	Touch the pipe along the flowing direction of refrigerant to feel the temperature difference. The difference is large or part of the pipe is frosting.	2.4.1 The block is caused by solder.	Cut off the pipe and check it.	Replace and solder the pipe.
						2.4.2 The pipeline is blocked by impurities.		Replace and solder the pipe.
				3. The ambient temperature is too low.	—	3.1 The outdoor ambient temperature is lower than -25°C in the heating mode.	Measure the outdoor ambient temperature.	—
		4. The pressure sensor is faulty.	—	4.1 The low pressure sensor is faulty.	Stop the whole system. Test the system's balance pressure 20 minutes later and convert the pressure into the corresponding saturation temperature. Compare it with the outdoor ambient temperature. If the difference is larger than 5°C, it is exceptional.	—	—	Replace the high pressure sensor.

			4.2 The high pressure and low pressure sensors are connected reversely.	Connect the stop valves of the module high- and low-pressure air pipes to the high and low pressure gauges and transform the readings into corresponding temperatures. Compare them to the high- and low-temperatures tested by the system. If the difference is larger than 5°C, it is exceptional.	—	—	Reconnect the high- and low-pressure sensors.
6. The fan is not working properly.	A. The IDU's fan does not work in the cooling mode. B. The ODU's fan does not work in the heating mode.	6.1 The IDU's fan is faulty.	Manual check	Manual check	6.1.1 The power cable connecting the motor and main board is loose.	Manual check	Reconnect the motor with the power cable.
					6.1.2 The electric capacity is not connected or is damaged.	Manual check	Connect or replace the electric capacity.
					6.1.3 The motor is damaged.	Other reasons	Replace the motor.
		6.2 The ODU's fan is faulty.	Manual check	Manual check	6.2.1 The fan motor is not properly connected with the control board of the motor.	Manual check	Reconnect it properly.
					6.2.2 The fan motor is not properly connected with the control board of the motor with the communication feedback cable.	Manual check	Reconnect it properly.
					6.2.3 The control board of the fan's motor is damaged.	Manual check	Replace the control board of the motor.
					6.2.4 The main board of the fan's motor is	Other reasons	Replace the motor.

						damaged.		
		7. Not enough refrigerant	Other reasons	Incorrect quantity of refrigerant is injected.	—	—	—	Check the necessary amount of refrigerant and inject refrigerant slowly via the stop valve of the low-pressure air pipe.

2.1.2.3 Poor cooling/heating performance

Feedback from user	Exception	Possible reasons						Solution
		Primary reason		Secondary reason		Tertiary reason		
		Description	Confirmation method	Description	Confirmation method	Description	Confirmation method	
Poor heating/cooling performance	A. When the IDU is working in the cooling mode and the electronic expansion valve is opened to the max., the exhaust temperature of the IDU's coil is more than 5°C higher than the intake temperature; B. when the IDU is working in the heating mode and the electronic expansion valve is opened to 2PLS, the intake temperature of the IDU's coil is more than 12°C lower than the saturation temperature corresponding to the high pressure;	1. The stop valve of the ODU is not fully opened as required.	—	—	—	—	Manual check	Fully open the stop valve.
		2. The system pipeline is blocked.	—	2.1. The system air pipeline is blocked.	Touch the pipe along the flowing direction of refrigerant to feel the temperature difference. The difference is large.	2.1.1 The block is caused by solder.	Cut off the pipe and check it.	Replace and solder the pipe.
						2.1.2 The pipeline is blocked by impurities.		Replace and solder the pipe.
				2.2 The fluid pipe is blocked.	Touch the pipe along the flowing direction of refrigerant to feel the temperature difference. The difference is large or part of the pipe is frosting.	—	—	Replace and solder the pipe.
						2.4 The pipe that connects the IDU is blocked.	Touch the pipe along the flowing direction of	2.4.1 The block is caused by solder.

				refrigerant to feel the temperature difference. The difference is large or part of the pipe is frosting.	2.4.2 The pipeline is blocked by impurities.		Replace and solder the pipe.
3. The ambient temperature exceeds the required range.	—	3.1 The ambient temperature of the IDU that works in the cooling mode is higher than 32°C.	Measure the outdoor ambient temperature.	3.1.1 The system has worked for less than 1 hour.	—	It is a normal phenomenon.	
				3.1.2 An improper system is selected.	—	Choose another system with larger power.	
		3.2 The outdoor ambient temperature in the cooling mode is higher than 40°C.	Measure the outdoor ambient temperature.	—	—	It is a normal phenomenon.	
		3.3 The ambient temperature of the IDU that works in the heating mode is lower than 12°C.	Measure the outdoor ambient temperature.	3.3.1 The system has worked for less than 2 hours.	—	It is a normal phenomenon.	
				3.3.2 An improper system is selected.	—	Choose another system with larger power.	
		3.4 The outdoor ambient temperature in the heating mode is lower than -7°C.	Measure the outdoor ambient temperature.	—	—	It is a normal phenomenon.	
4. Poor airflow distribution design	—	4.1 The air intake and return inlet of the ODU are too close to each other, affecting the heat exchange	Check the distance.	—	—	Re-design the airflow distribution.	

				performan ce of the unit.				
				4.2 The air intake and return inlet of the IDU are too close to each other, causing poor heat exchange of the unit.	Check the distance.	—	—	Re-design the airflow distribution .
		7. Not enough refrigeran t	Other reasons	Incorrect quantity of refrigerant is injected.	—	—	—	Check the necessary amount of refrigerant and inject refrigerant slowly via the stop valve of the low-pressu re air pipe.

## 2.2 Flowchart analyzing

### 2.2.1 High exhaust temperature protection (E4)

When the system shows high exhaust temperature protection for compressor, the IDU will show high exhaust temperature fault E4, while the IDU will show the specific faulty compressor.

For example, when high exhaust temperature protection is enabled on compressor 2# of module 3# of the ODU, IDUs will show E4 and the module will show E6, indicating that high exhaust temperature protection is enabled on compressor 2#.



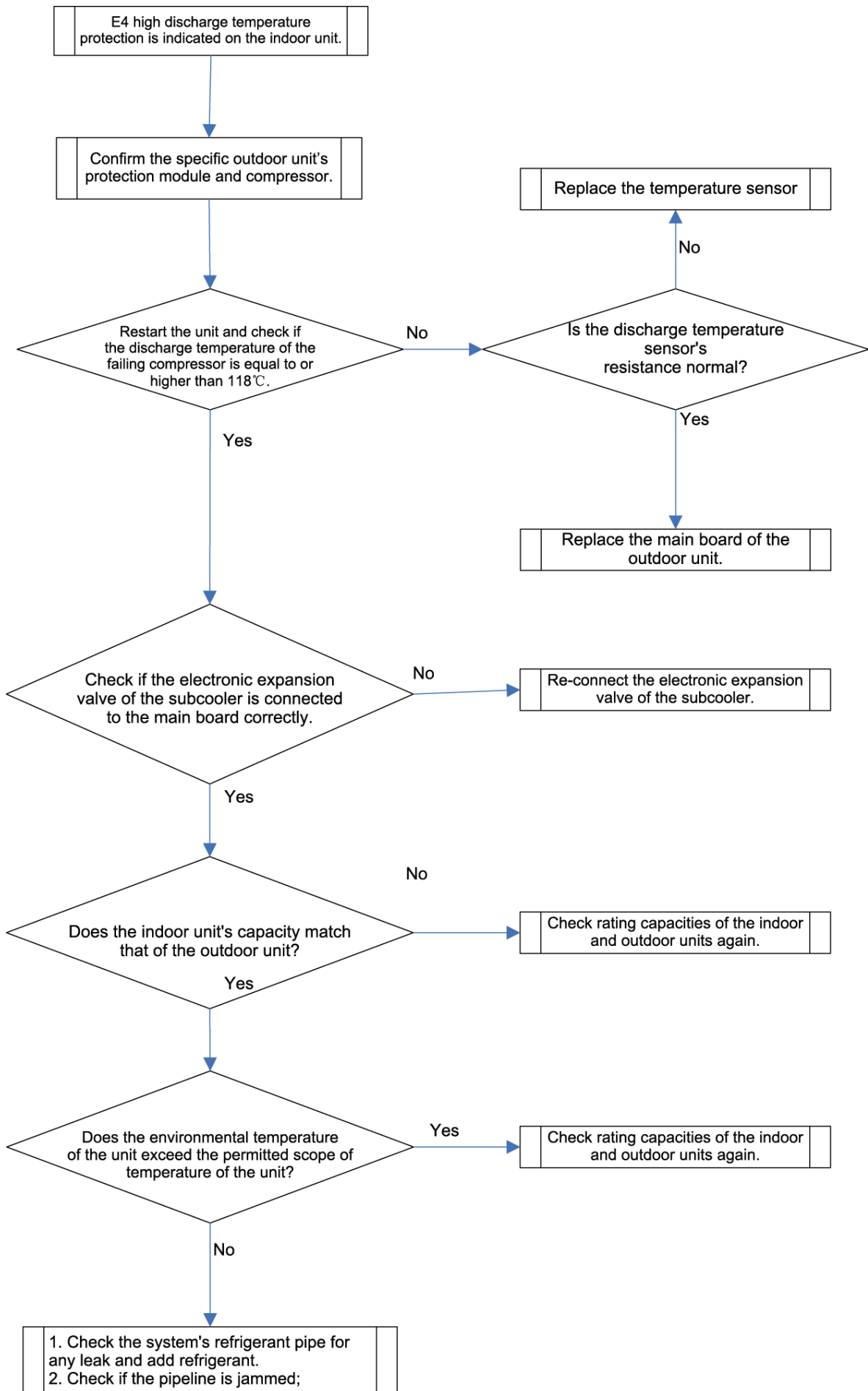

**2.2.2 Low exhaust temperature protection (E2)**

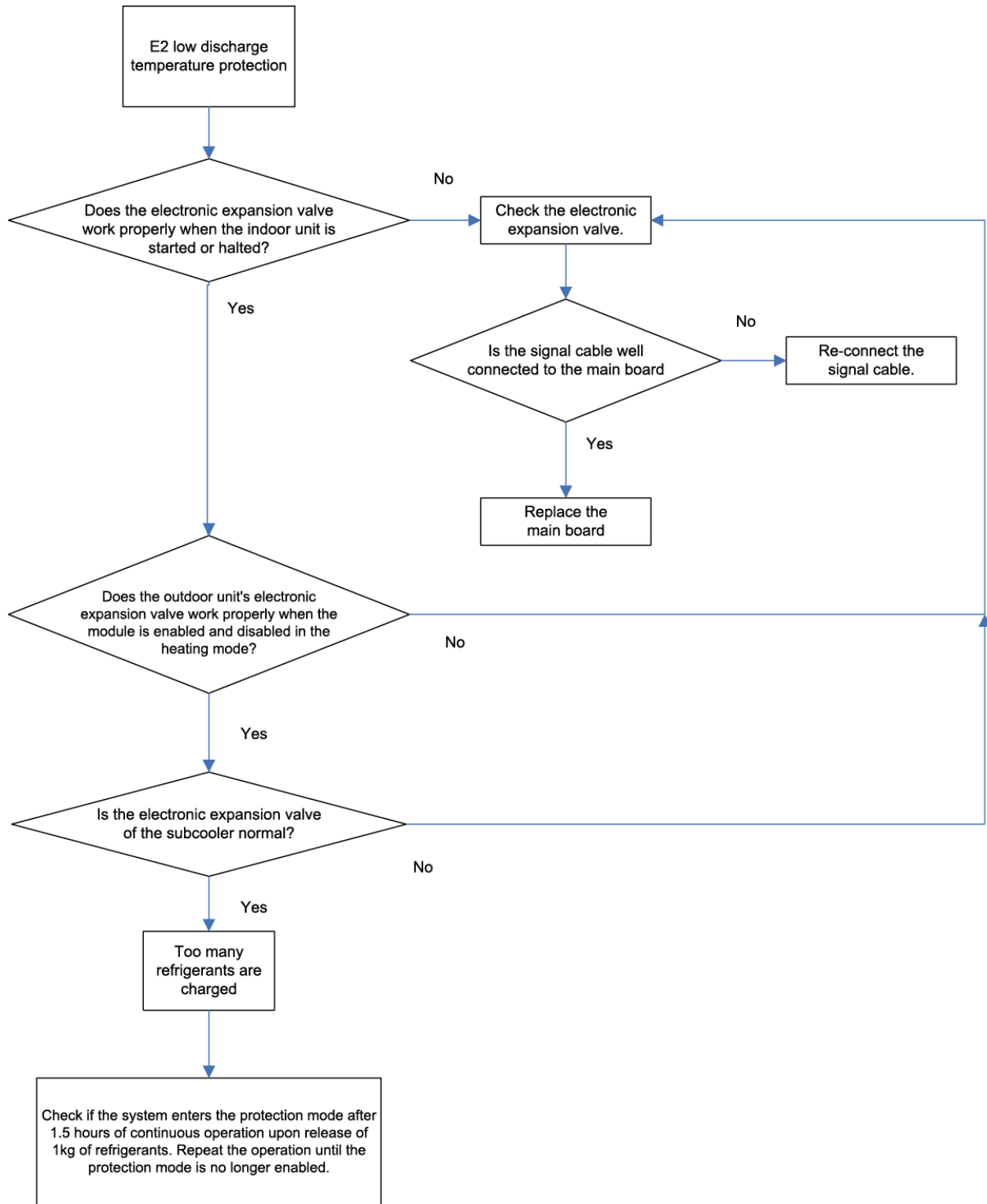

**2.2.3 System high pressure protection (E1)**

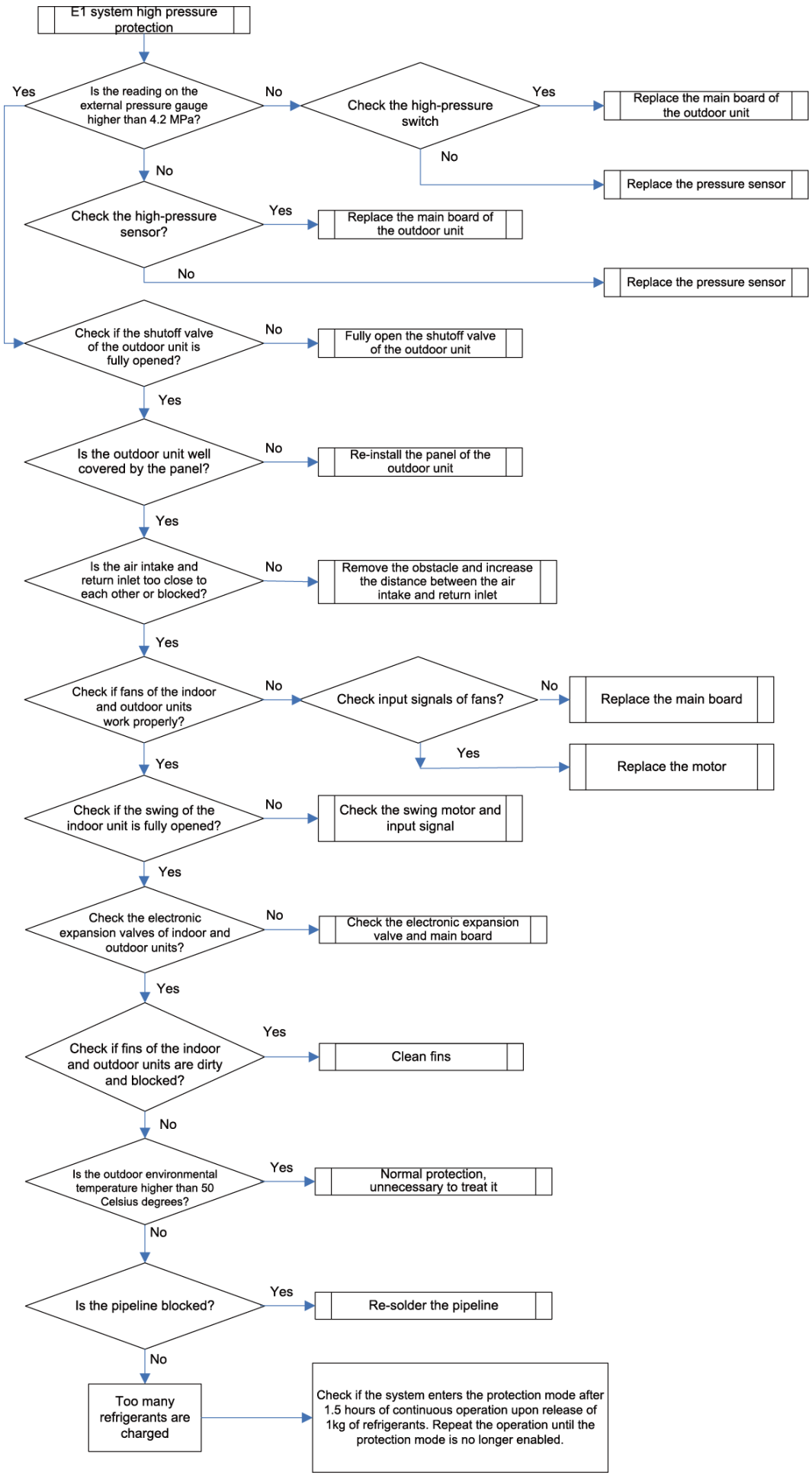

2.2.4 System low pressure protection (E3)

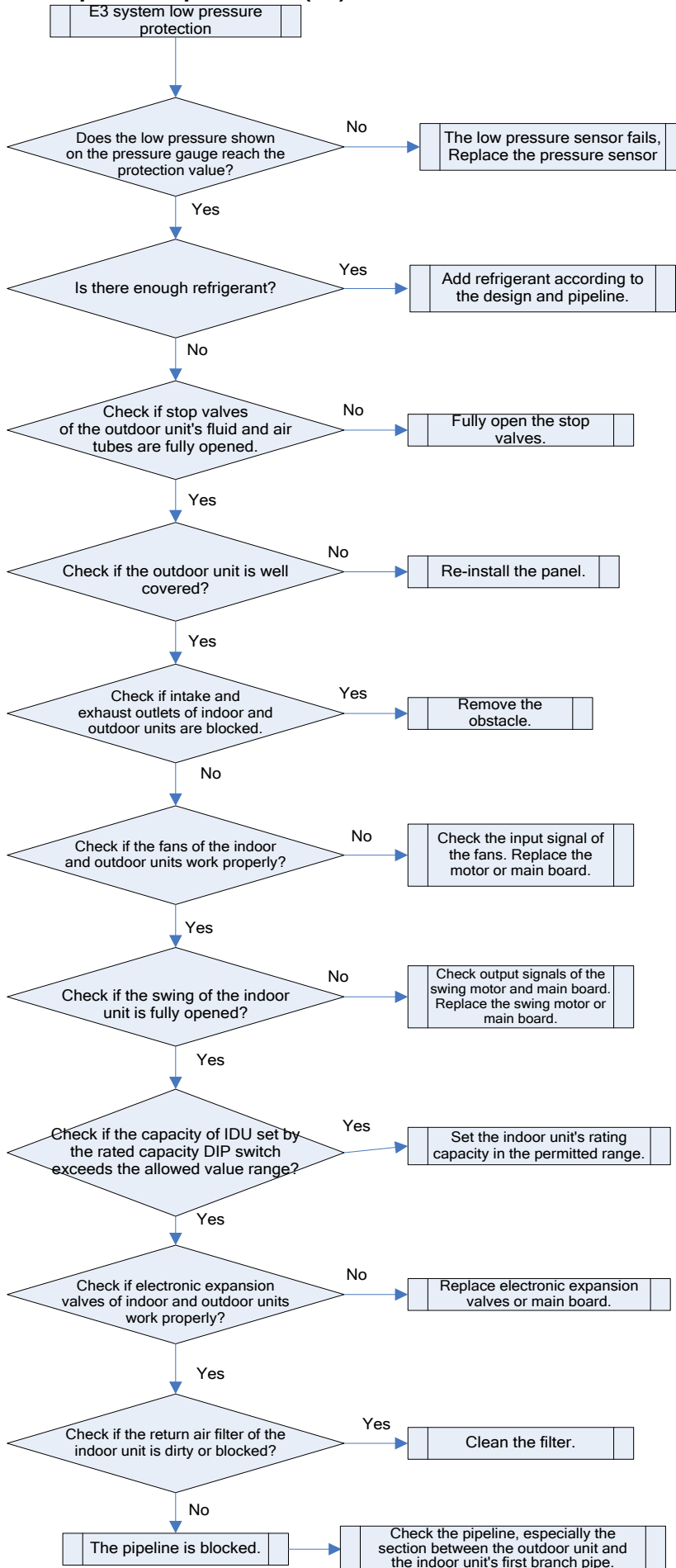

2.2.5 System refrigerant lacking protection (U4)

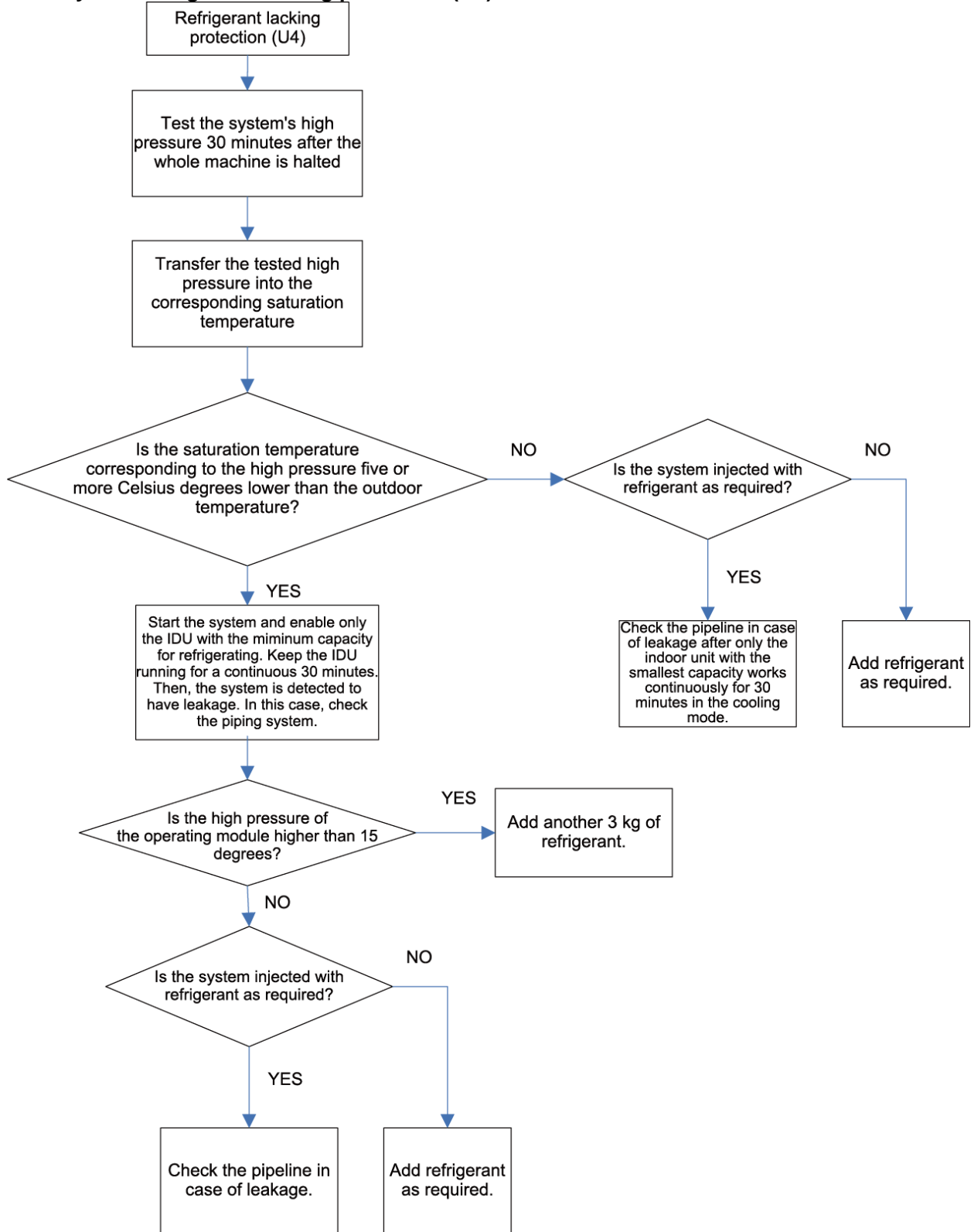

2.2.6 System high pressure ratio protection (J8)

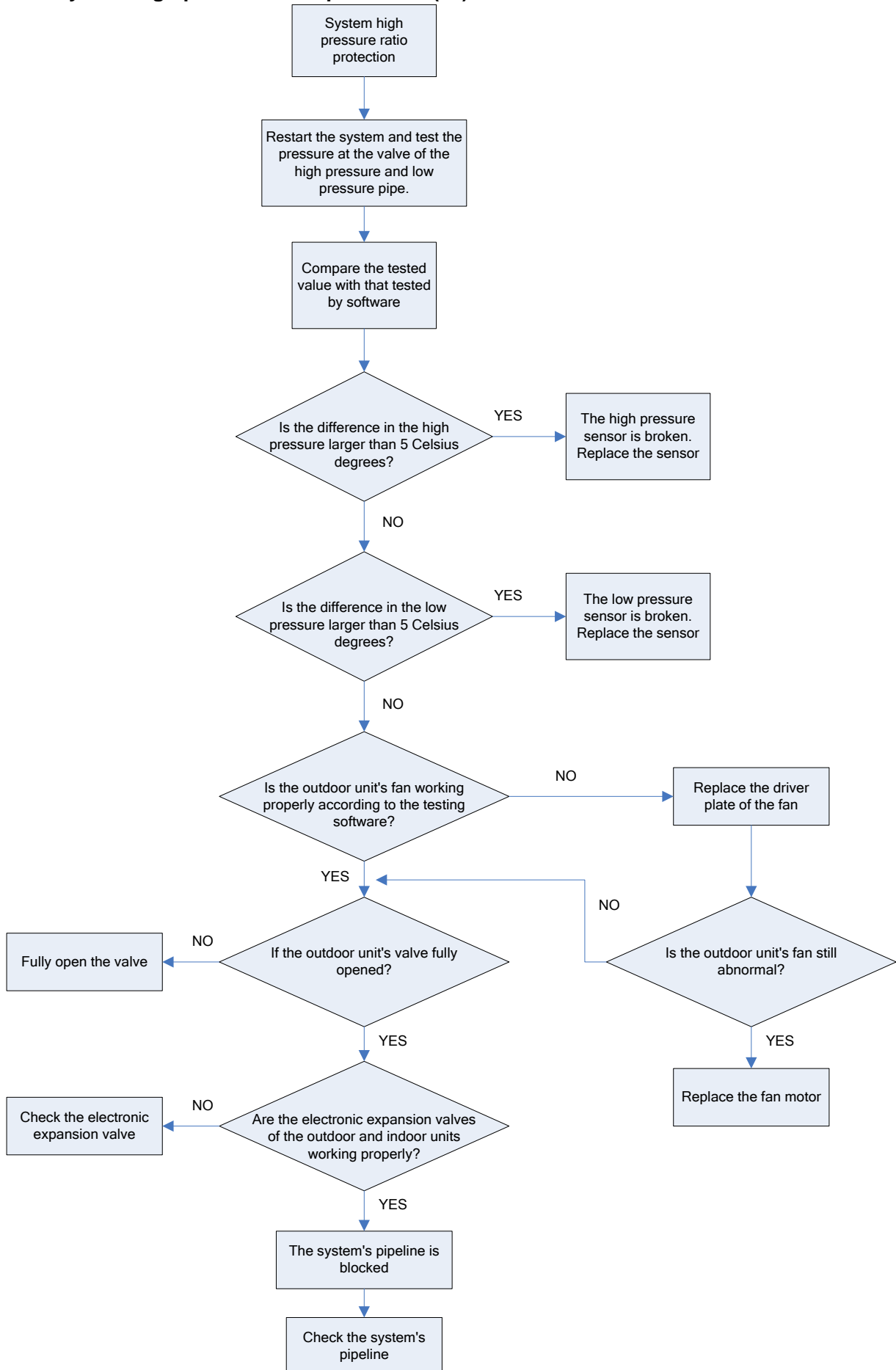

2.2.7 System low pressure ratio protection (J9)

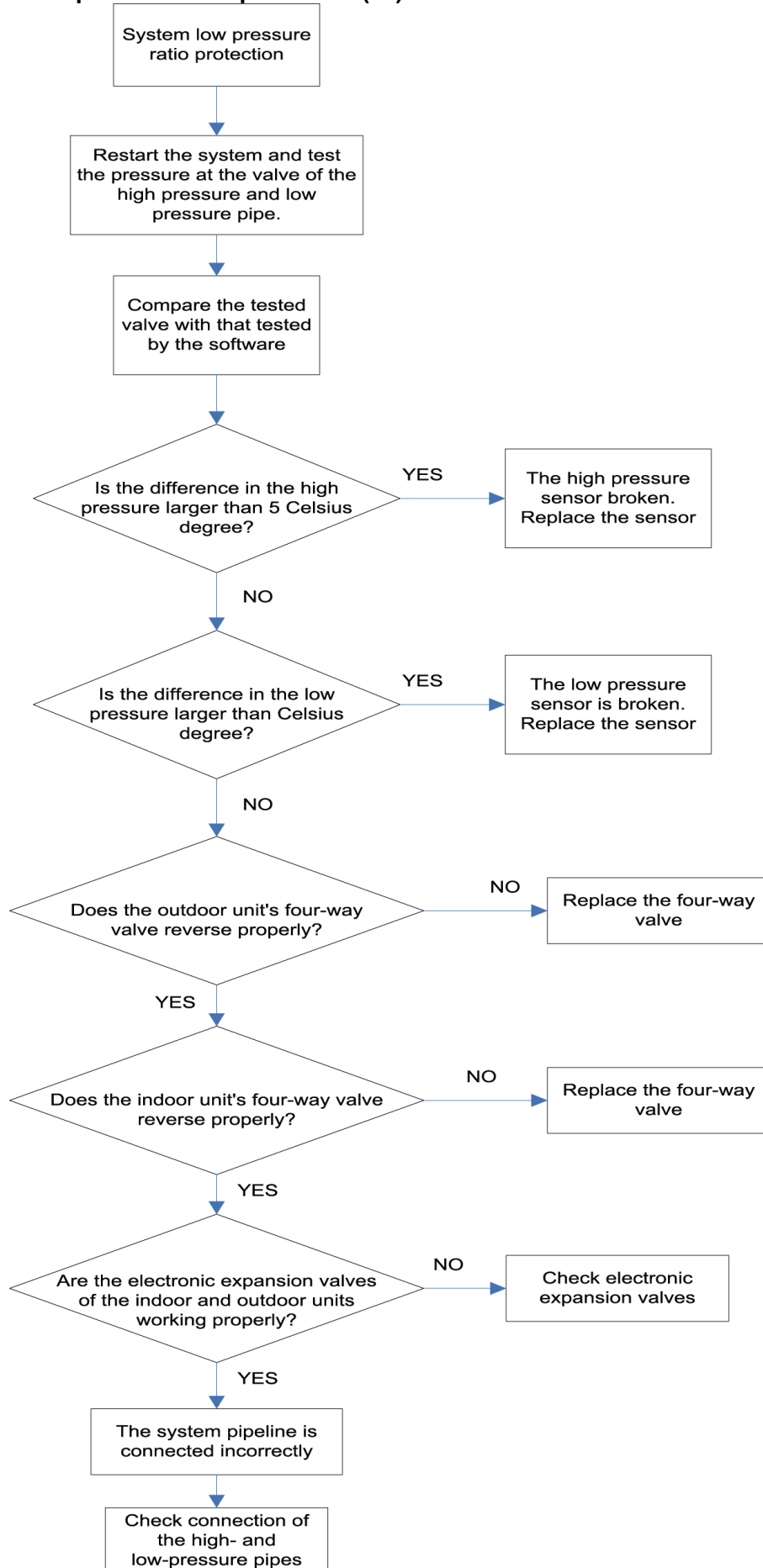

2.2.8 Indoor unit anti-freezing protection (L5)

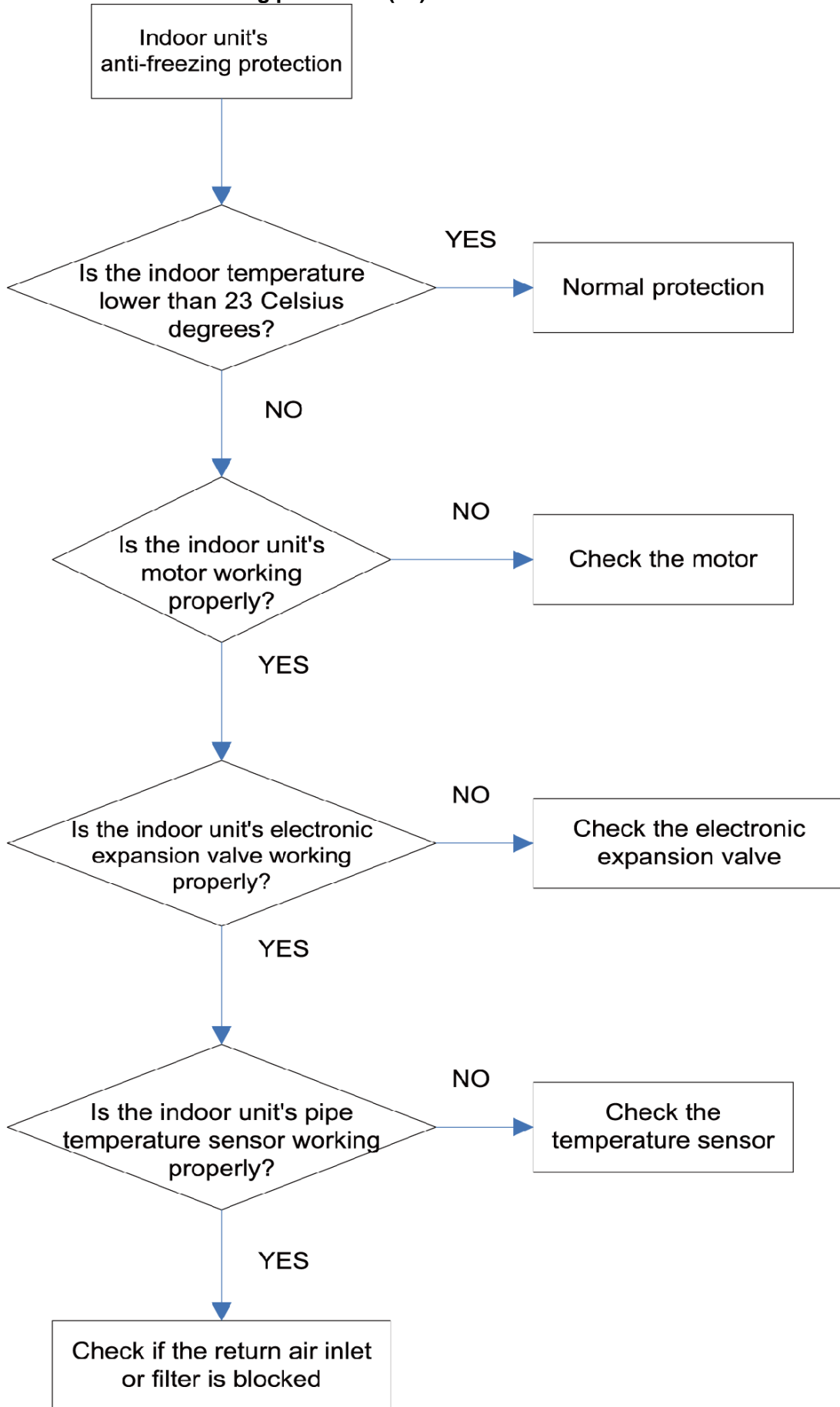



**2.2.9 Indoor unit water overflow protection (L3)**

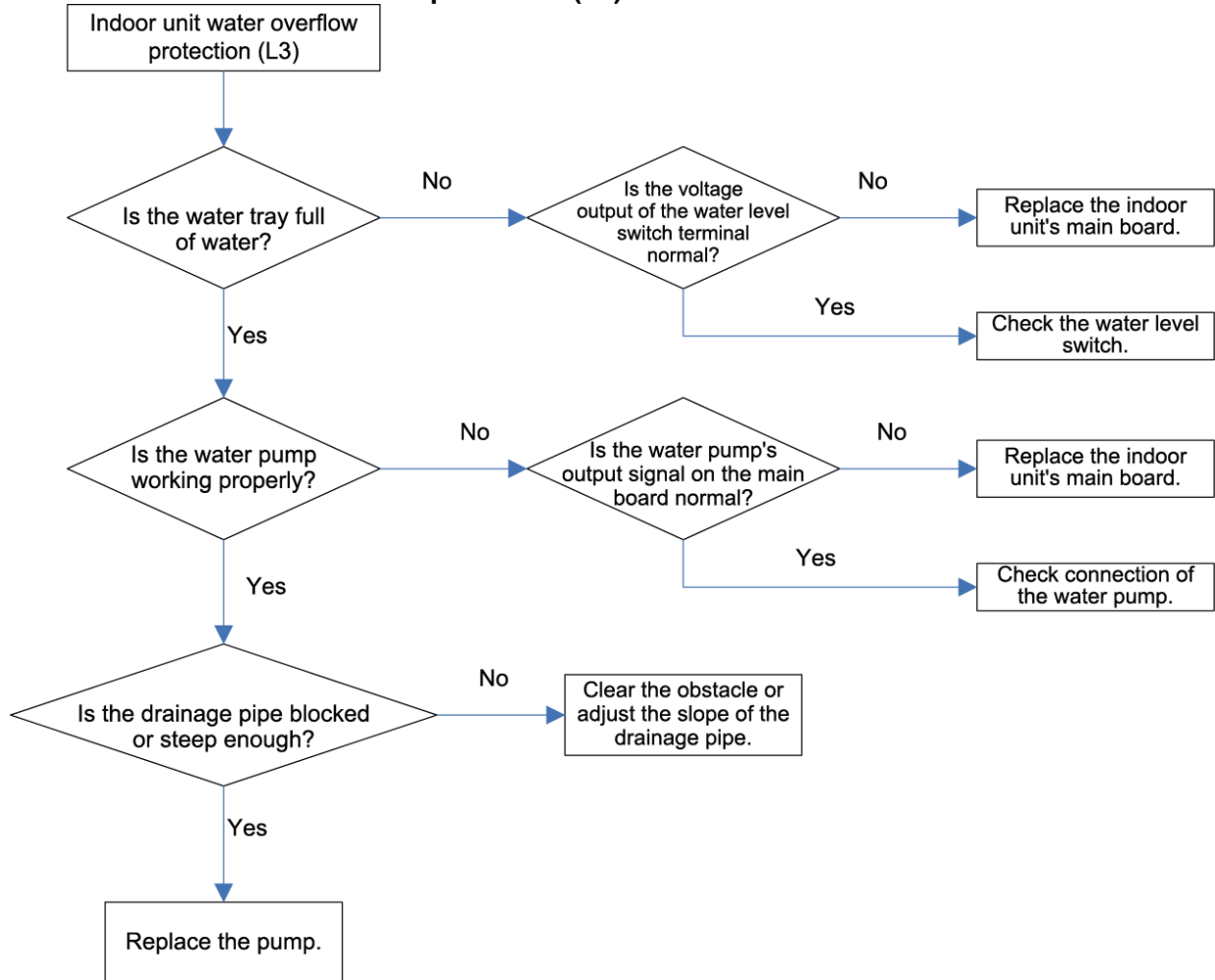

**2.2.10 Temperature sensor fault**

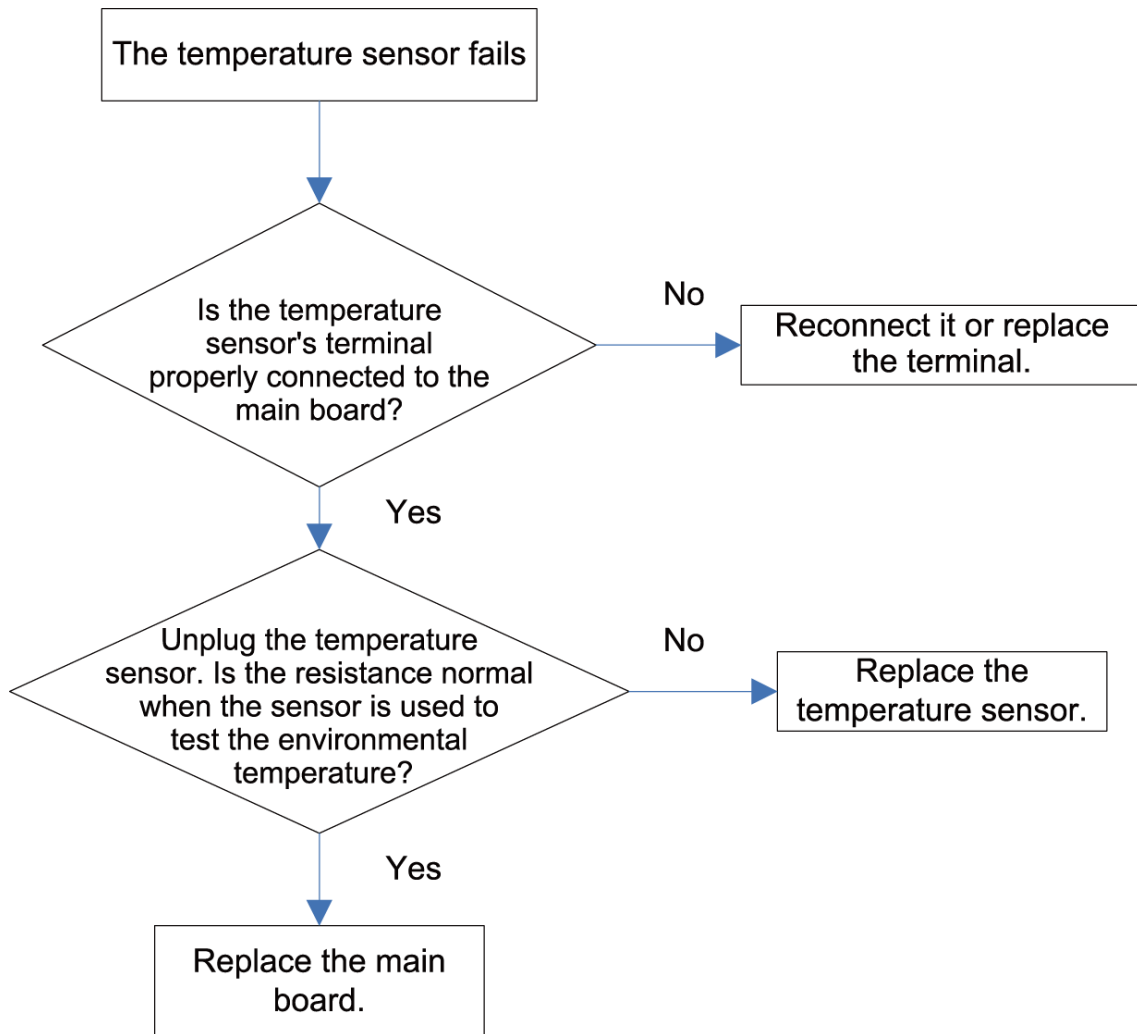

2.2.11 Pressure sensor fault

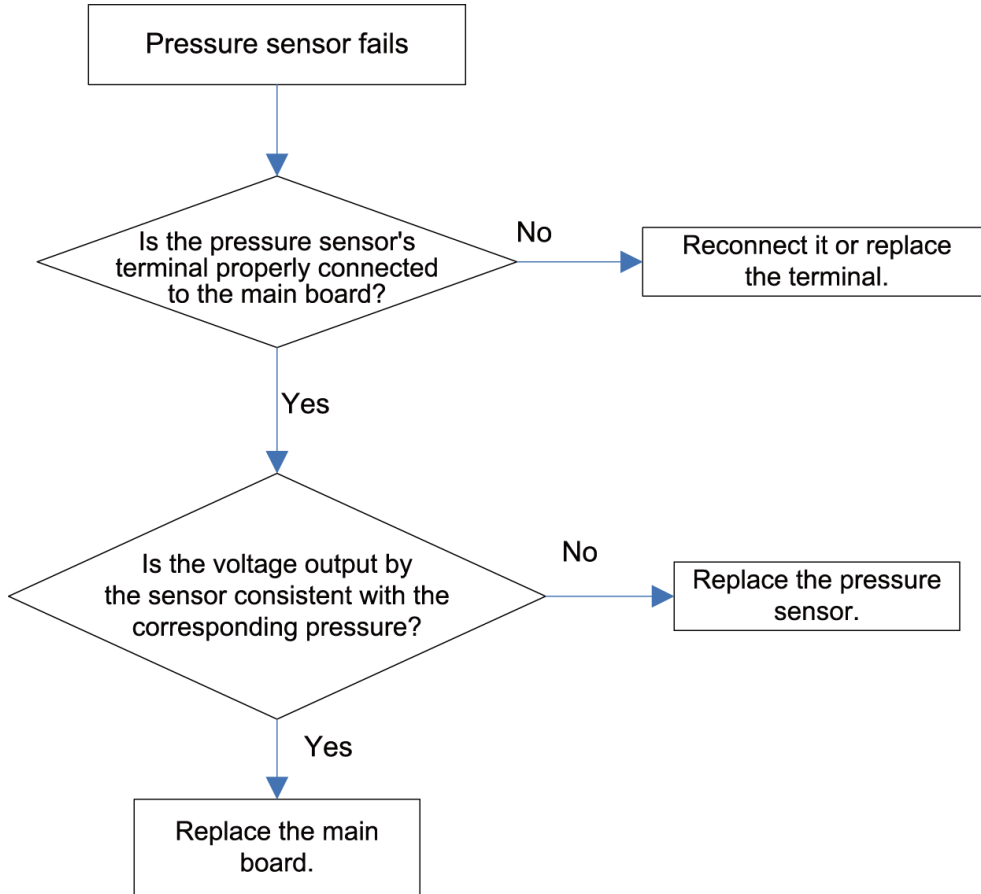

**2.2.12 Analyzing of drive control system faults**

When the unit fails and halts, first check the two-digit nixie tube of the control board and fault table to find out the specific fault. Then check and solve the fault according to the following methods.

(1) Communication failure between the compressor's drive board and control board (outdoor fault C2)

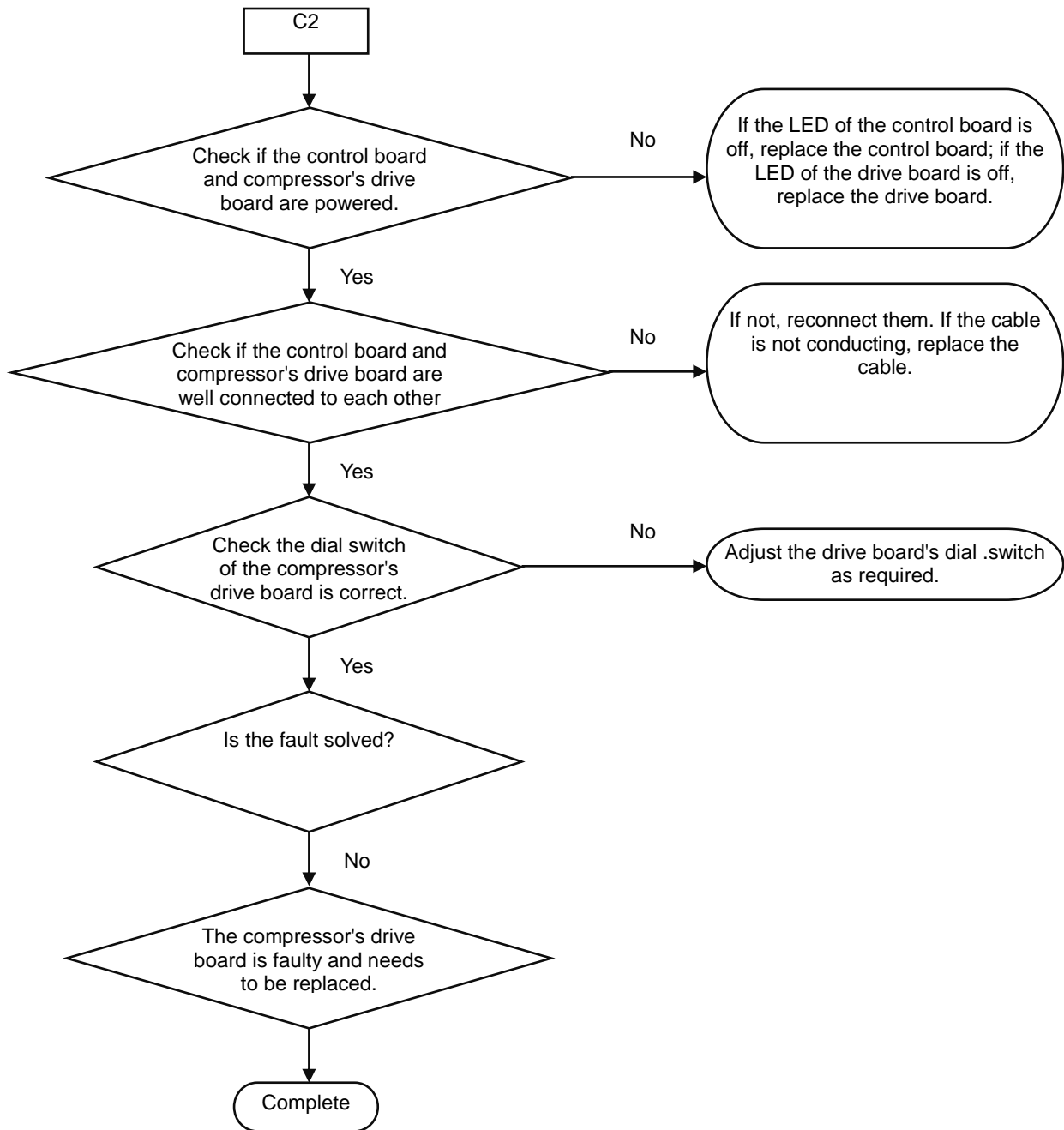

(2) Faults in the IPM temperature sensor of the variable-frequency compressor's drive board (IDU fault P7), current detection circuit (ODU fault PC), drive module reset protection (ODU fault P3) and out-of-step protection (ODU fault P9)

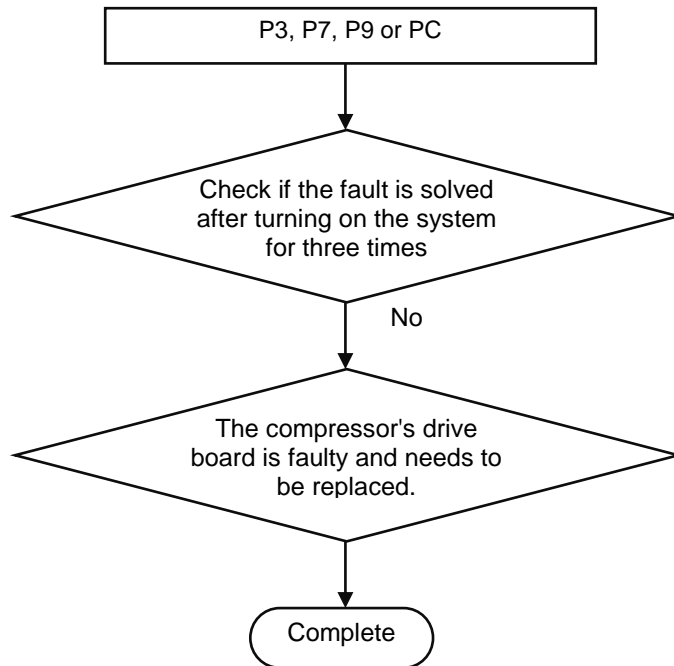

(3) Variable-frequency compressor over-current protection (ODU fault P5) and IPM module protection faults (ODU fault P6)

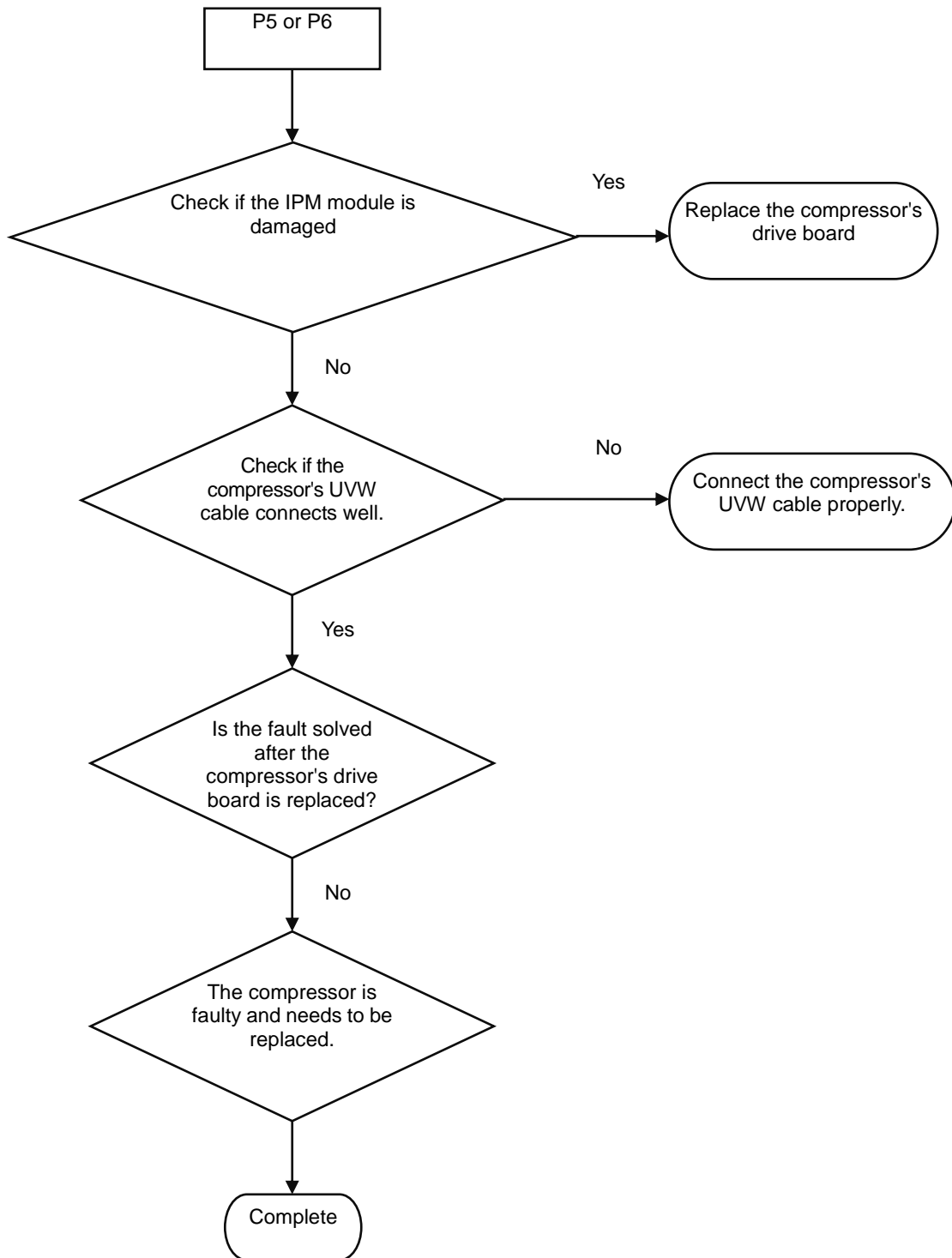

**Attachment: How to check whether the IPM module is damaged**

1. Preparation: Find a digital multi-meter and switch it to the diode. Remove U, V and W cables of the compressor from the drive board two minutes after the system is powered off. Make sure that it is tested at least two minutes after the system is powered off.

2. Method: Use the black probe of the multi-meter to touch the place marked by P in the follow picture and the red probe to touch places marked by U, V and W respectively and record readings of the multi-meter. Use the red probe to touch the place marked by N and black probe to touch places marked by U, V and W respectively and record readings of the multi-meter.

3. Analyzing: If the reading ranges between 0.3 V and 0.7 V in the above-mentioned six scenarios, the IPM module is normal. If the reading is 0 in one or multiple scenarios, the IPM module is damaged.



(4) Variable-frequency compressor drive board IPM over-temperature fault (ODU fault P8)

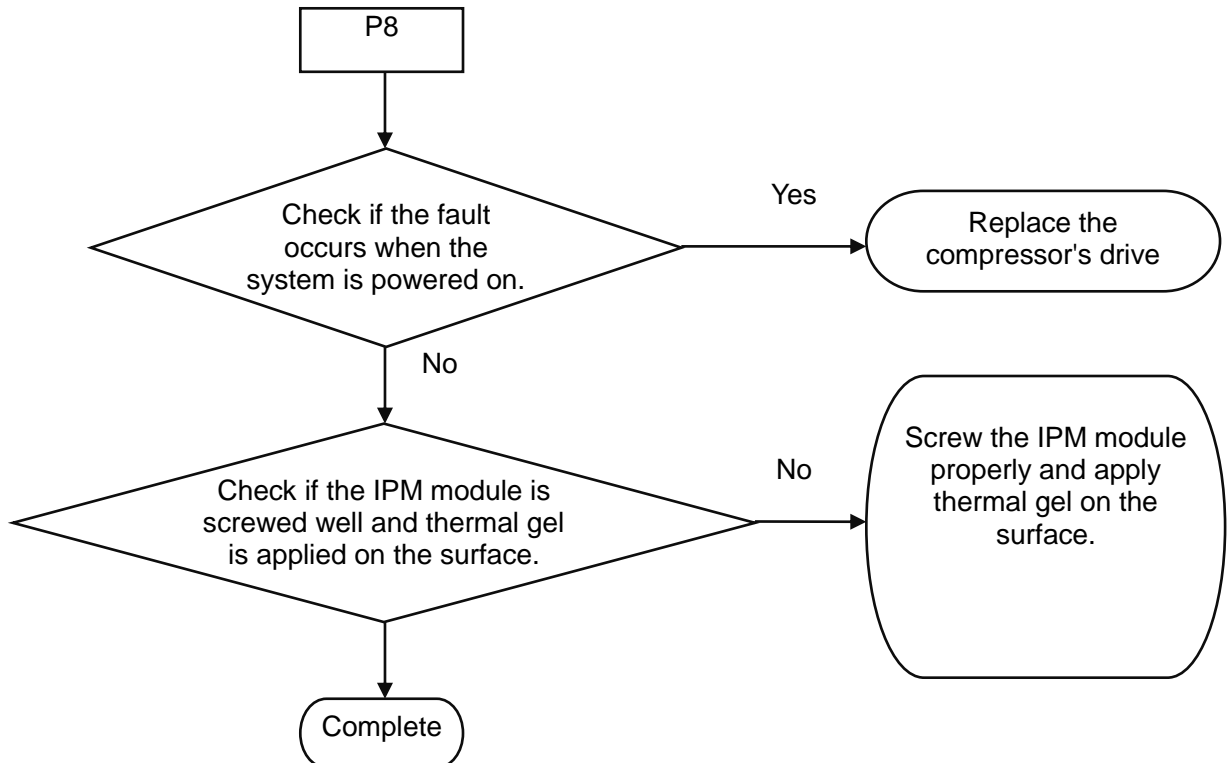

(5) Recharging circuit faulty of the variable-frequency compressor drive board (ODU fault PF)

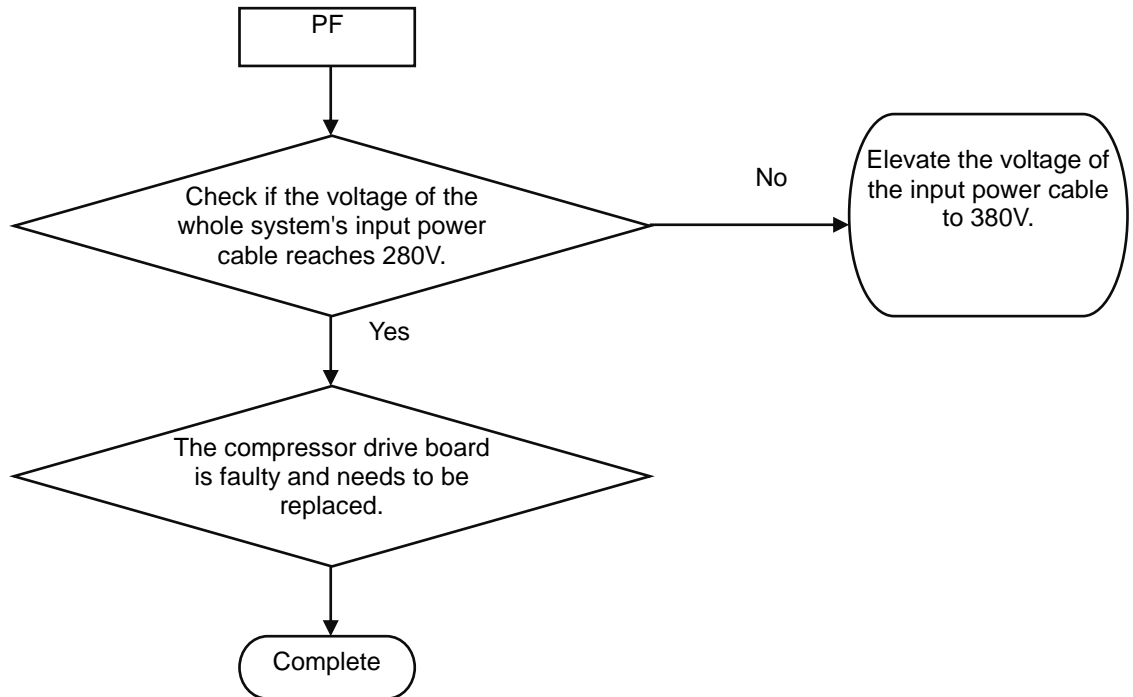

(6) High voltage protection for the DC bus of the variable-frequency compressor's drive board (ODU fault PH)

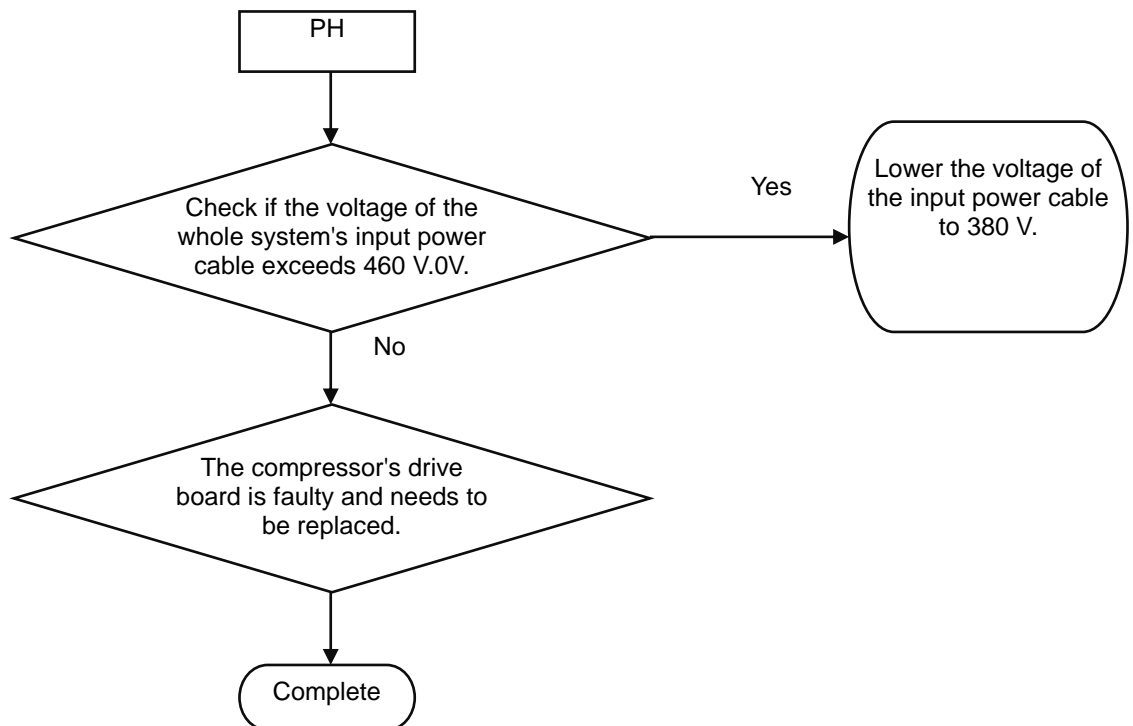



(7) Low voltage protection for the DC bus of the variable-frequency compressor's drive board (ODU fault PL)

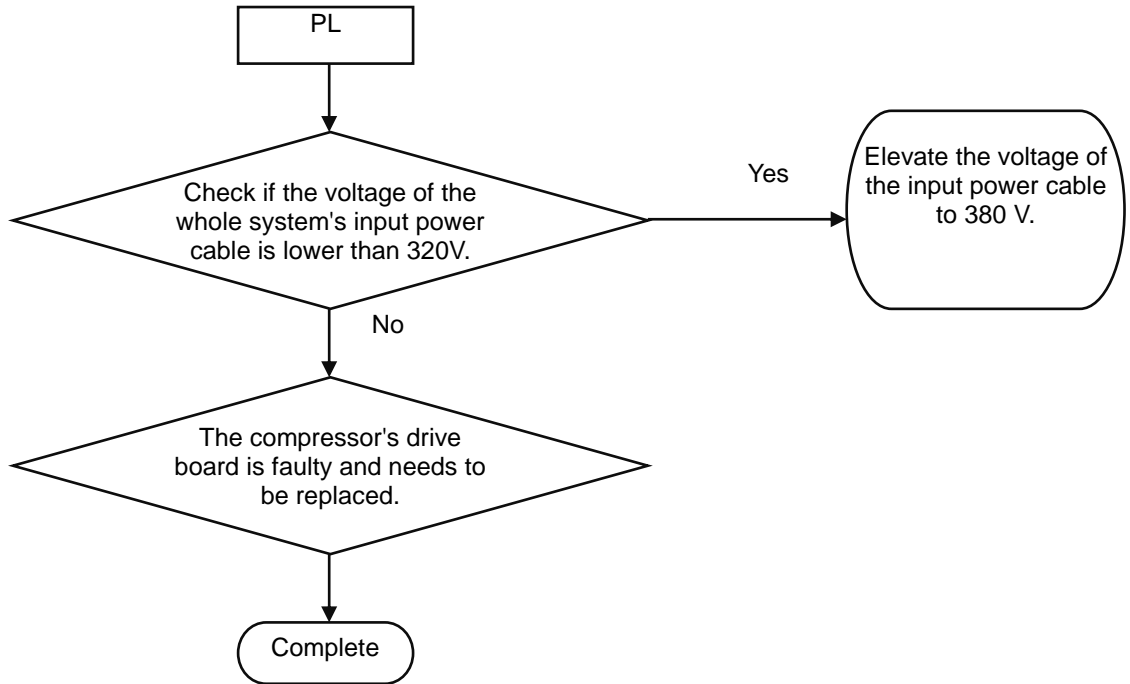

(8) Variable-frequency compressor starting failure (ODU fault PJ)

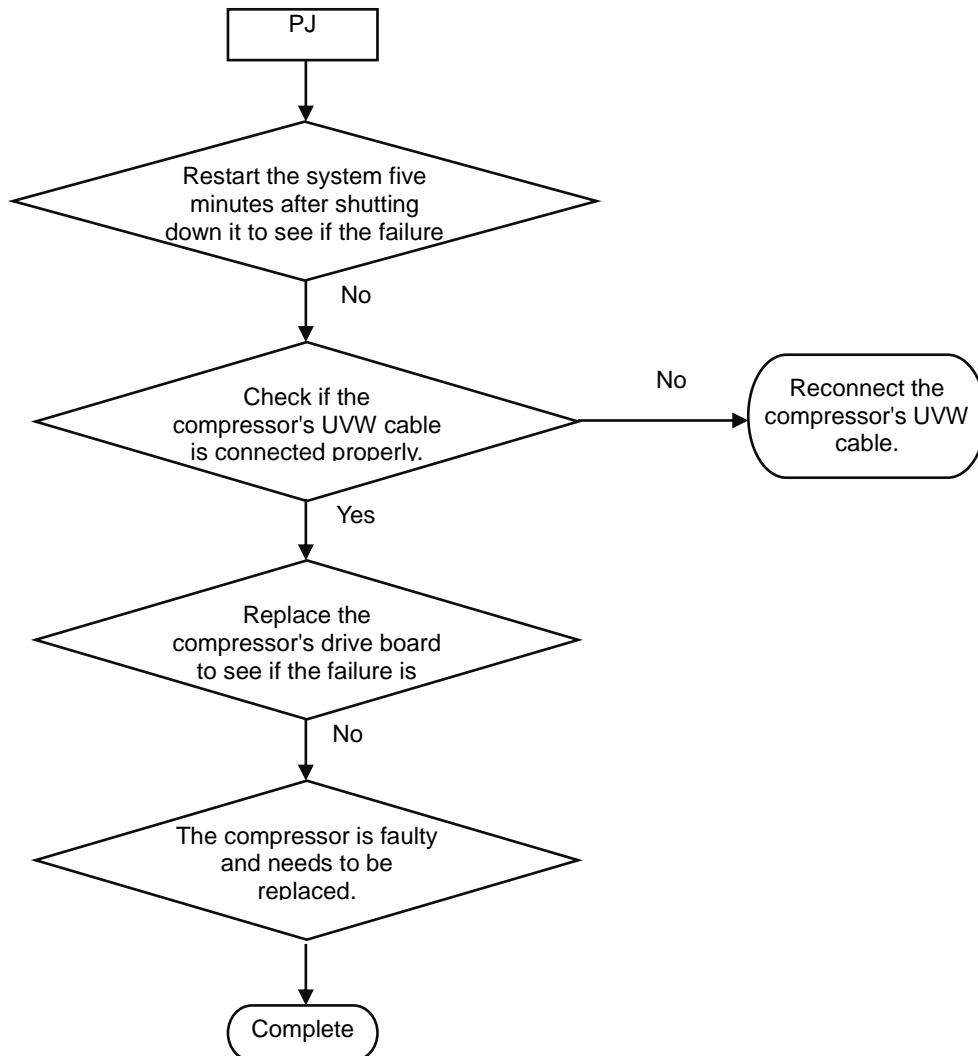

**2.2.13 Analyzing of faults in the variable-frequency fan drive's control system**

(1) Communication failure between the fan's drive board and control board (outdoor fault C3)

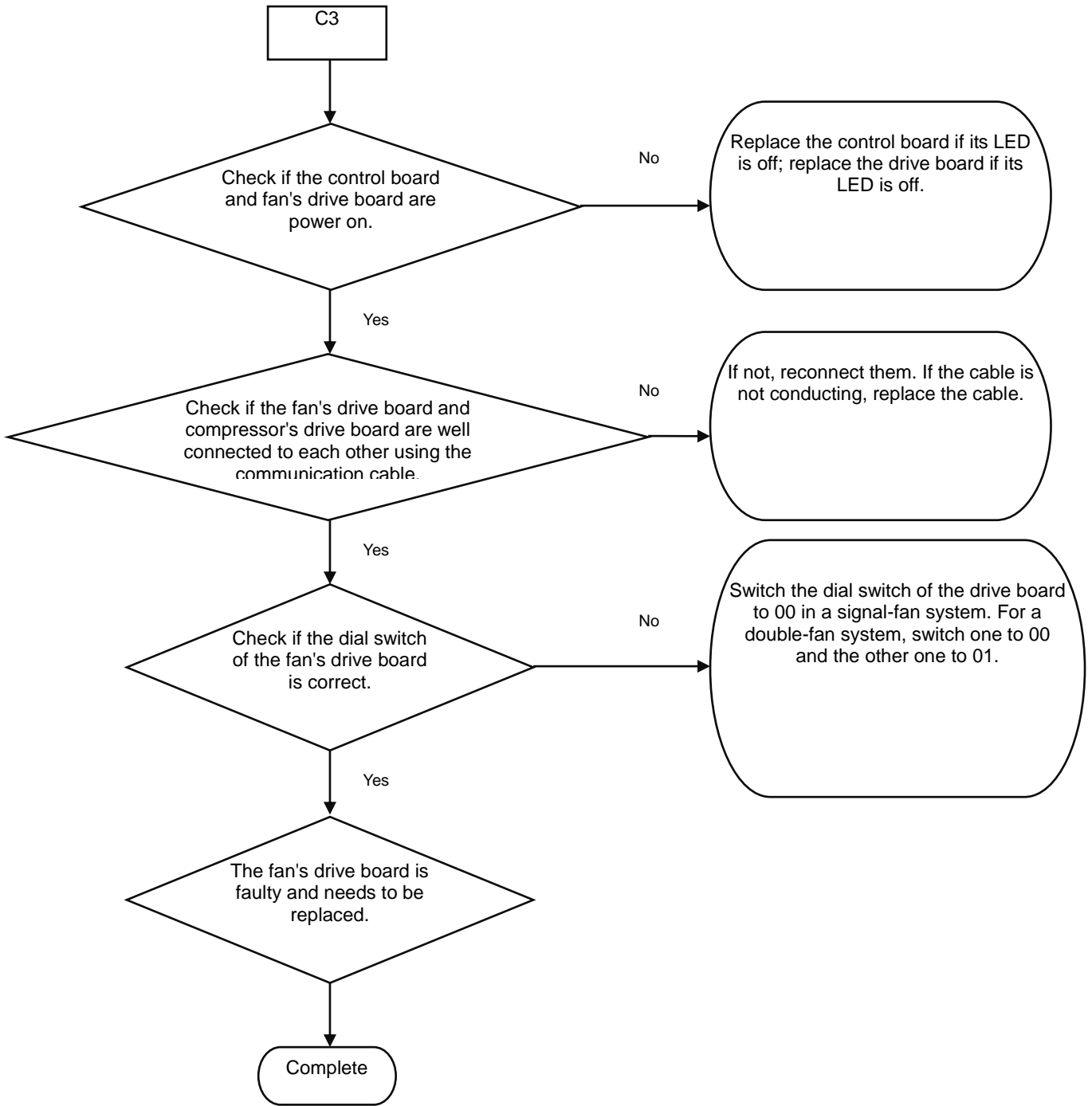

(2) Faults in the IPM temperature sensor of the fan's drive board (ODU fault H7), current detection circuit (ODU fault HC) and out-of-step protection (ODU fault H9)

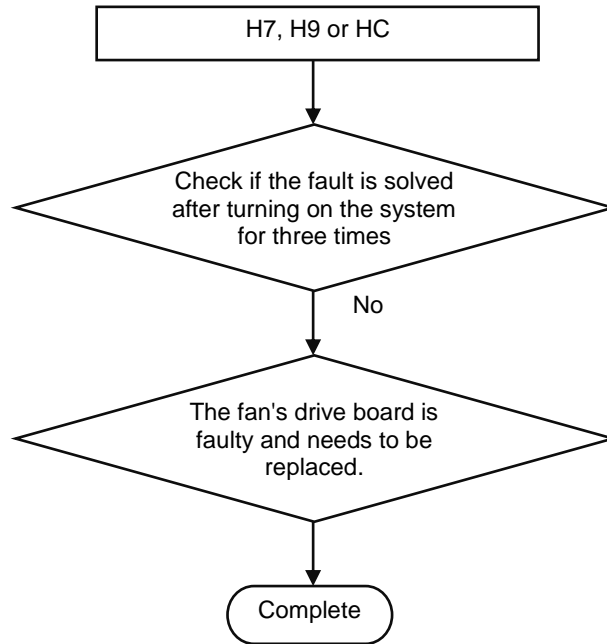

(3) Variable-frequency fan over-current protection and IPM module protection faults (ODU fault H5 and H6)

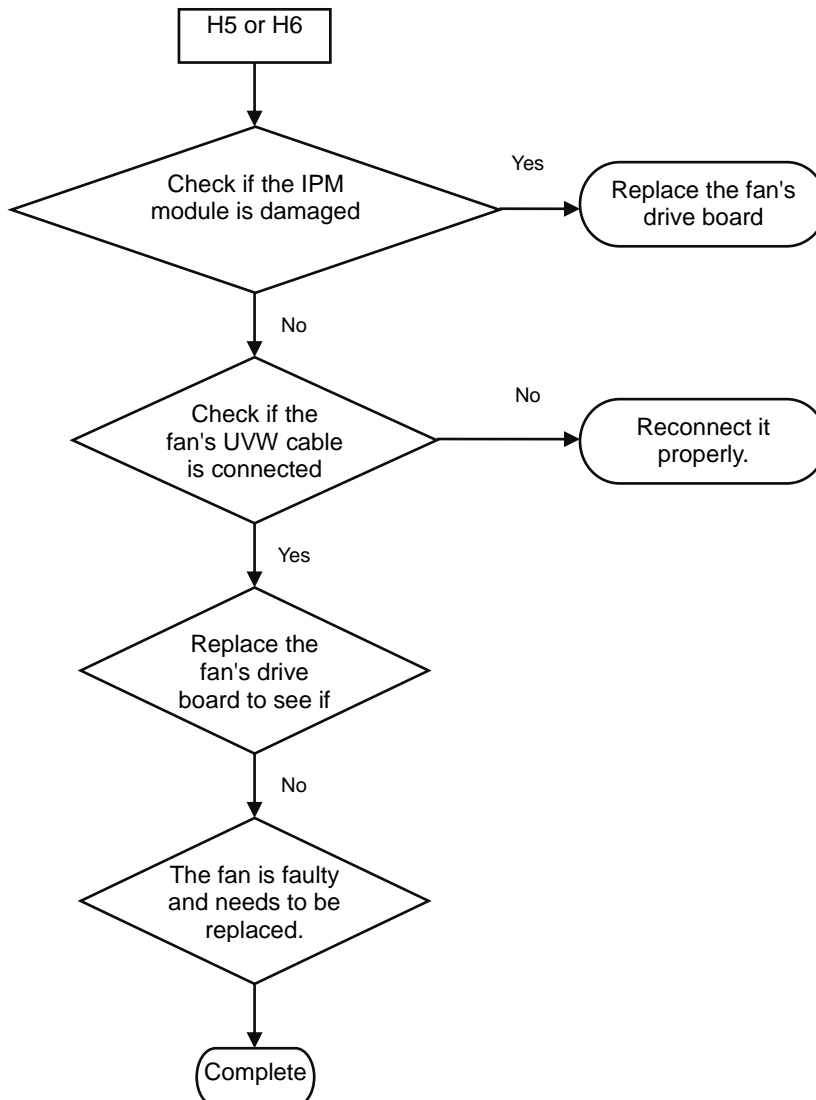

**Attachment: How to check whether the IPM module is damaged**

① Preparation: Find a digital multi-meter and switch it to the diode. Remove U, V and W cables of the fan from the drive board two minutes after the system is powered off. Make sure that it is tested two minutes after the system is powered off.

② Method: Use the black probe of the multi-meter to touch the place marked by P in the follow picture and the red probe to touch places marked by U, V and W respectively and record readings of the multi-meter. Use the red probe to touch the place marked by N and black probe to touch places marked by U, V and W respectively and record readings of the multi-meter.

③ Analyzing: If the reading ranges between 0.3 V and 0.7 V in the above-mentioned six scenarios, the IPM module is normal. If the reading is 0 in one or multiple scenarios, the IPM module is damaged.

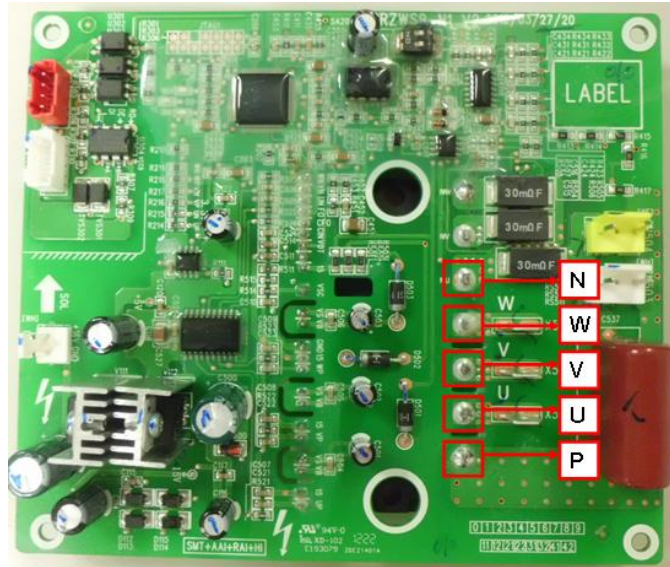

(4) Variable-frequency fan drive board IPM over-temperature fault (outdoor fault H8)

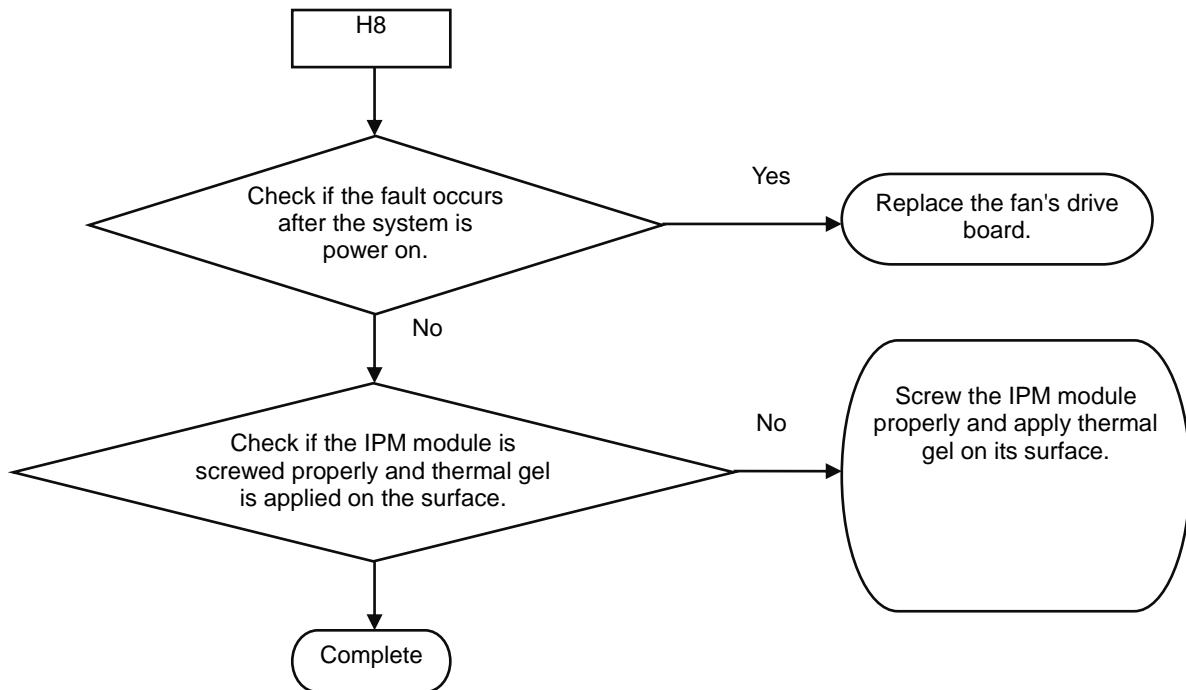

(5) High voltage protection for the DC bus of the variable-frequency fan's drive board (ODU fault HH)

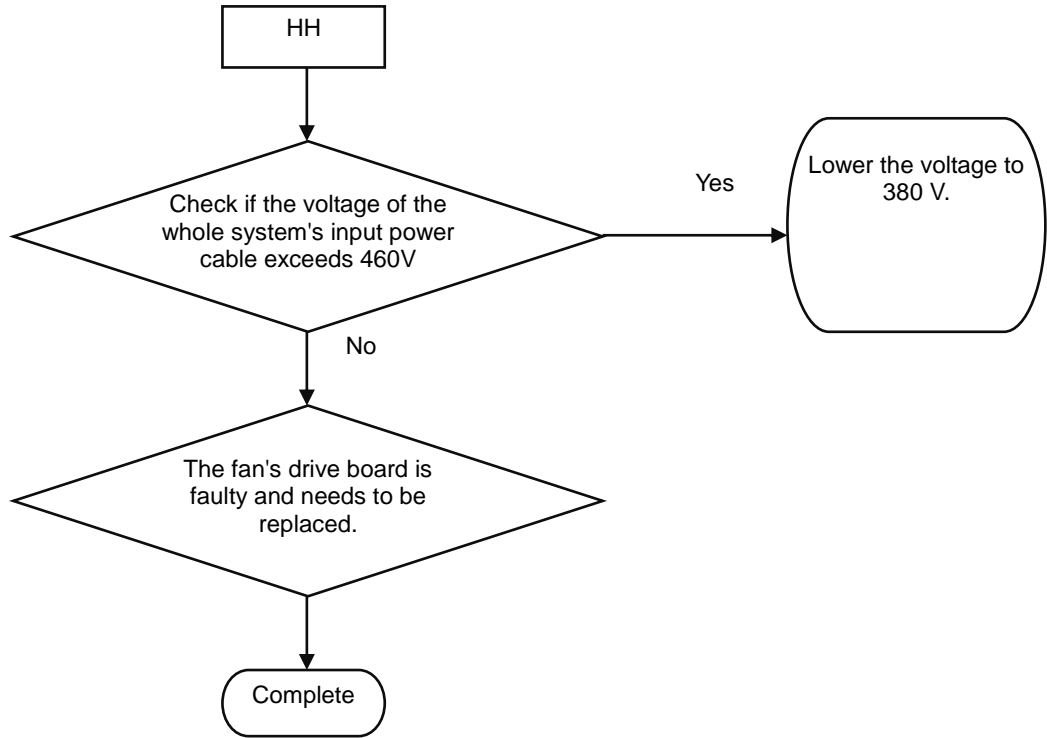

(6) Low voltage protection for the DC bus of the variable-frequency fan's drive board (ODU fault HL)

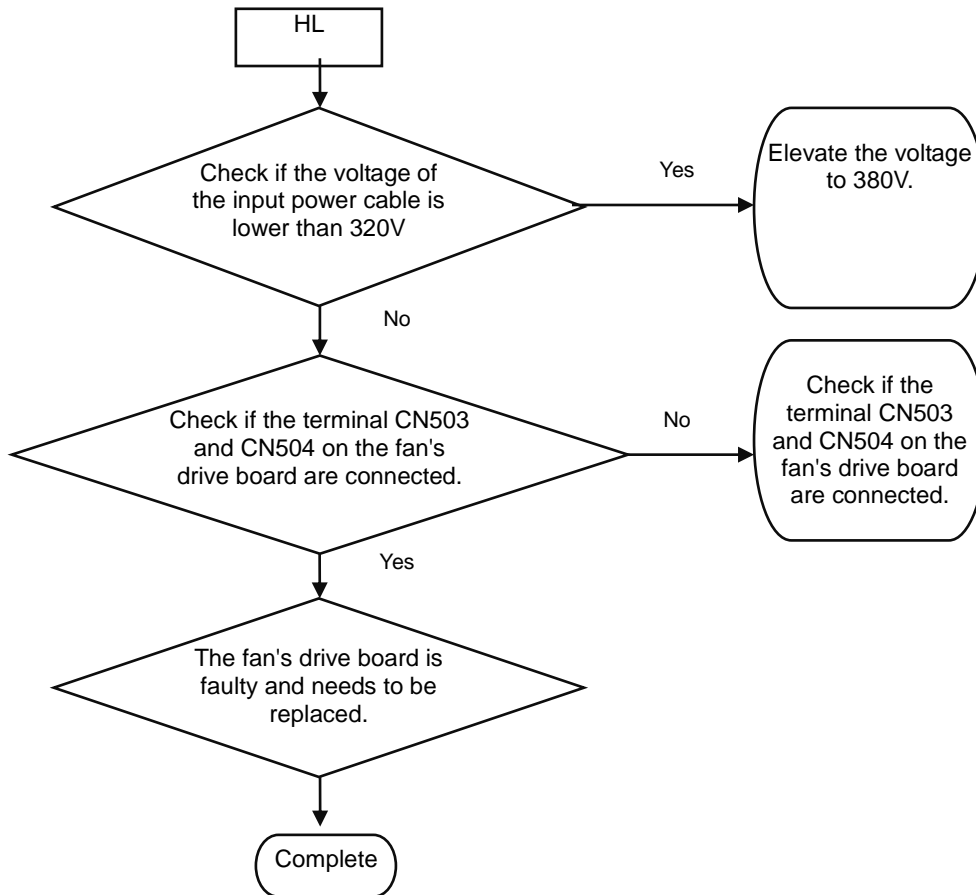

(7) Variable-frequency fan starting failure (ODU fault HJ)

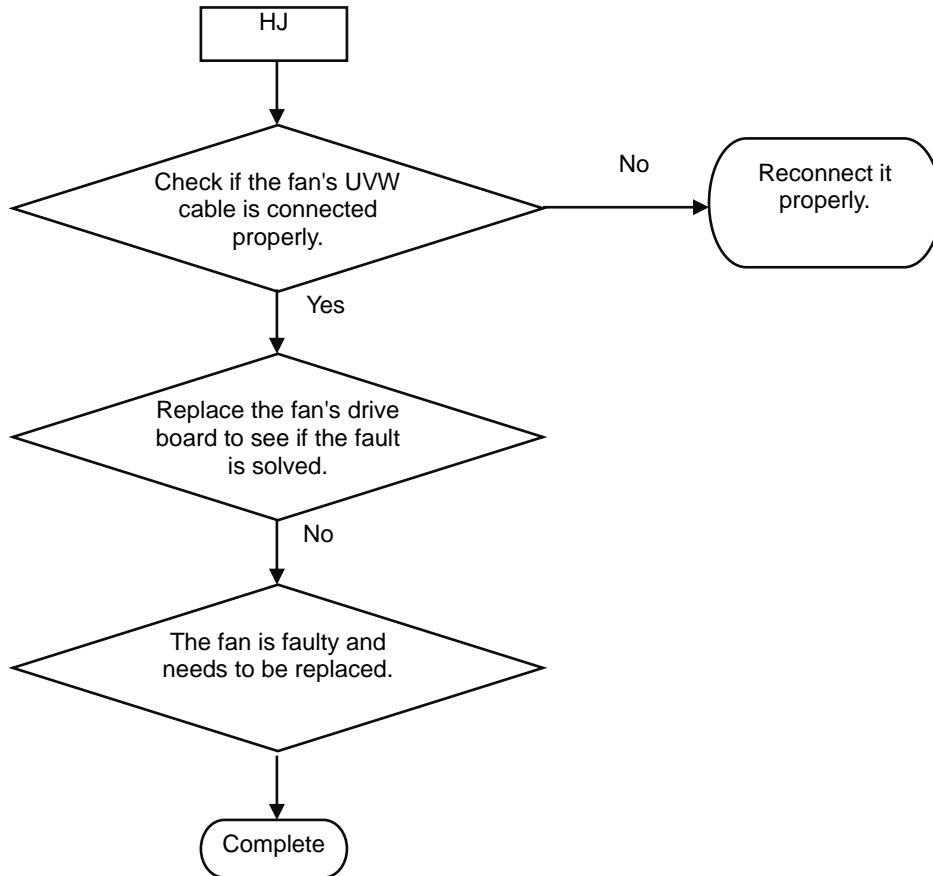

# 3 Key Parts Maintenance

## 3.1 Cautions on Controller AP1 Replacement

### 3.1.1 Cautions on ODU AP1 Replacement

#### 3.1.1.1 Distinguishing Master Module from Slave Module

Before replacing ODU AP1, determine the module is a master ODU or a slave ODU. They can be distinguished based on:

①“Master module DIP state (SA8\_MASTER-S)”

Every cooling system has only one master module (set in power-off state). When a DIP is “ON”, the corresponding position is “0”; when the DIP is “OFF”, the corresponding position is “1”. If SA8\_MASTER-S is set to “00”, it indicates a master module; if it is set to “10”, it indicates a slave module (as shown in the figure below).

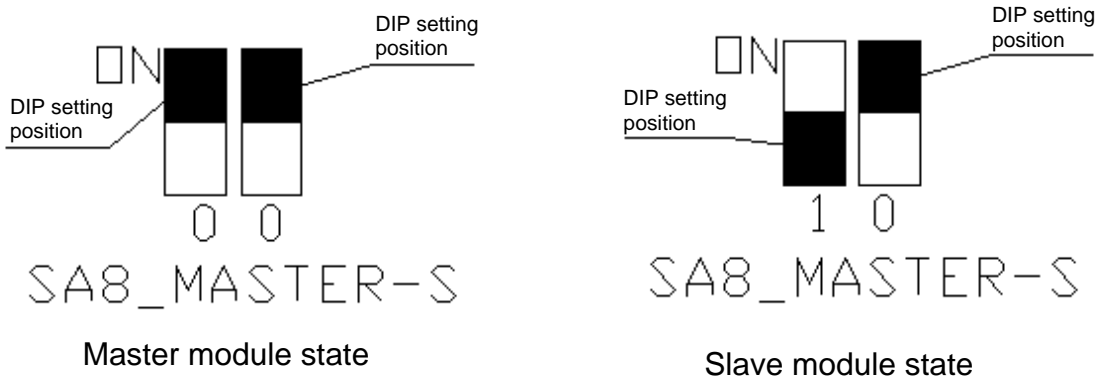

②AP1 LED

When a master module is powered on, LED1 is displayed as “01”. For a slave module, LED1 is displayed as “02”, “03” or “04” (as shown in the figure below).

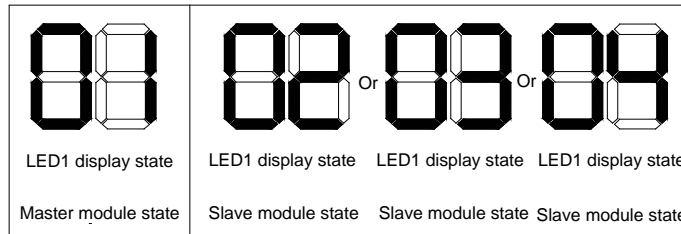

#### 3.1.1.2 Cautions on Replacement of Master ODU AP1

Before replacing master module AP1, make the following preparations:

①Master module DIP setting

Set the new AP1 identical to the faulty AP1. Note that settings must be performed when the master ODU is powered off and they will take effect after the ODU is powered on. Settings that are performed in power-on state are invalid.

②Communication state check

After AP1 DIP setting and all wiring, power on the master ODU AP1 and check whether D3 and D4 LEDs are flashing. See the figure below:

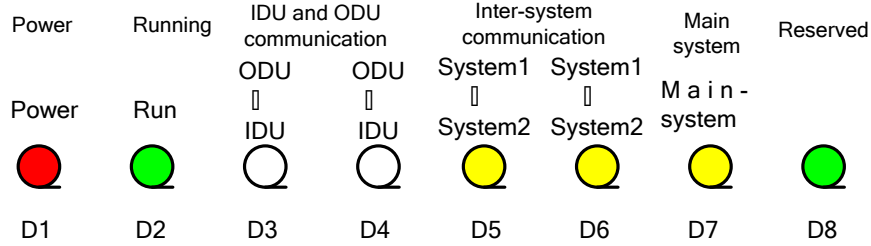

If the LEDs flash, the ODU and IDUs normally communicate; if the LEDs are steadily on, communication is faulty. Check communication lines connecting the ODU and IDUs.

Note: After AP1 is replaced, you should power on the ODU and IDUs at the same time or power on the ODU first; otherwise, "CC does not have module" will be prompted and a "C0 fault" alarm will be reported by the IDUs.

③ Master ODU engineering debug setting

Debug the entire system after master module AP1 replacement.

④ System parameter setting

After system debug, reset system parameters. For details, refer to section 1 "ODU Function Setting", in part II, chapter III.

3.1.1.3 Cautions on Replacement of Slave ODU AP1

Before replacing slave module AP1, set DIP identical to that of the faulty AP1, check wiring, and then power on the AP1.

3.1.2 Cautions on IDU AP1 Replacement

Before replacing IDU AP1, determine the module is a master IDU or a slave IDU.

3.1.2.1 AP1 DIP Setting and Jumper Cap Confirmation

Whatever the AP1 you replace is a master IDU AP1 or a slave IDU AP1, after it is replaced, check original DIP setting and model.

Configure capacity DIP for the new AP1 and confirm its jumper cap, fan overload detect terminal, and overflow detect terminal. They should be kept identical to those of the faulty AP1.

Their positions and corresponding silkscreen are as follows:

Capacity DIP: S1 (Capacity)

Jumper cap: U22 (Jump)

Overflow detect terminal: CN35(WATER-DTCT)

Fan overload detect terminal: CN36(OVC-FAN)

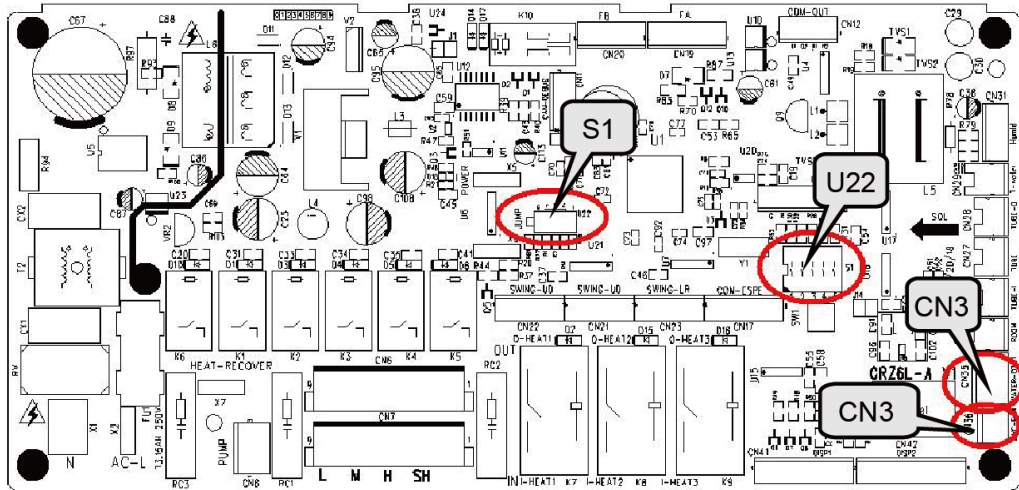

3.1.2.2. Restoring AP1 Engineering Parameters to Factory Settings (This Step Is Not Required for Original Packaged Parts)

After wiring, whatever the AP1 is a master IDU AP1 or a slave IDU AP1, the new AP1 must be restored to factory settings. There are three methods to restore engineering parameter settings:

- ① If the IDU is configured with wired control, set P35 and P36 to default values.
- ② If the IDU is configured with wireless control, use the special control YV1L1 to set P35 and P36 to default values.
- ③ If the IDU is configured with wireless control and special control, you can restore engineering settings through the AP1 SW1 button. After AP1 is powered on, press and hold SW1 for 5 seconds. If a tick sound is heard, release the button.



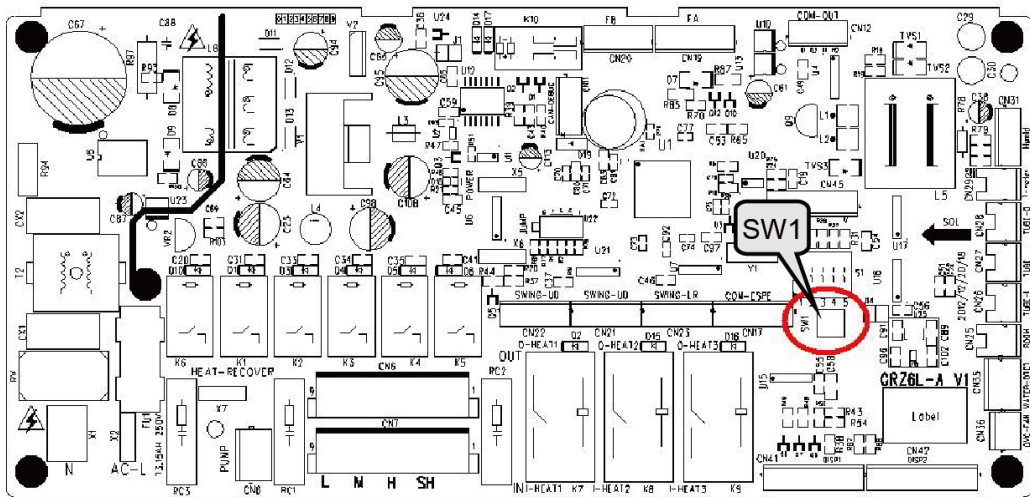

3.1.2.3 Cautions on Replacement of Master IDU AP1

If the AP1 of the master IDU needs to be replaced, after the IDU is powered on, “No master IDU (L7)” or “Project number conflict (C5)” alarm may be reported.

① Troubleshoot for “no master IDU (L7)” fault

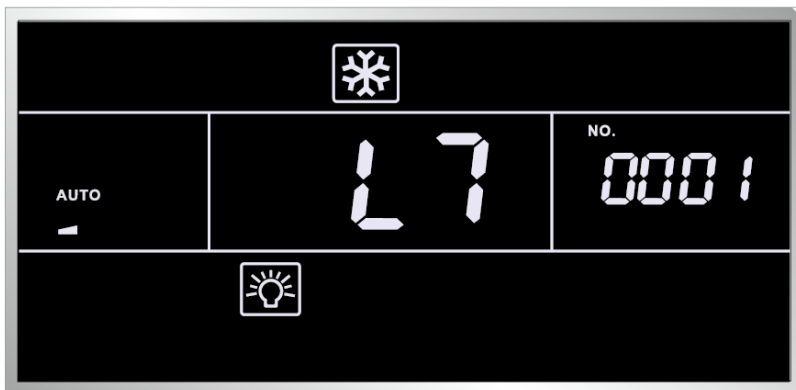

Method 1: If the IDU is configured with wired control, stop the IDU (except for lock mode) and press and hold the “MODE” button for 5 seconds to enter setting mode. After setting, the “Master” icon will be highlighted and the wired control buzzer will beep once.

Method 2: If the IDU is configured with lamp board or wired control, set to fan mode, 30°C/86°F, and press and hold “-” and “+” consecutively three times within 5 seconds. The IDU and wired control will identify it as a master IDU setting command, and show “set master IDU success (UC)” (5 seconds) and highlight the “Master” icon respectively.

Method 3: If the IDU is configured with the Debugger, set the IDU to master IDU through this software.

② Troubleshoot for “project number conflict (C5)”



If this fault occurs, the number of the new AP1 is identical to that of a unit within the network. Manually change it to the original number of the faulty AP1 or a unique number. There are three methods to change project number:

Method 1: If the IDU is configured with wired control, set P42 to a new project number.

Method 2: If the IDU is configured with lamp board, use the special control YV1L1 to set P42 to a new project number.

Method 3: If the IDU is configured with the Debugger, configure a new project number through this software.

Tip:

If there are N units within the network, the units should be numbered from N+1.

Special situation:

In some cases, the created project number is identical to that of a unit within the network. In this case, you can use the “one-key IDU project number reset” function. However, this function will cause the project number of the entire system to be re-distributed; thus, original number will be changed. If you do not expect this result, forbid the use of this function and replace the AP1 again.

Methods to use the “one-key IDU project number reset” function:

Method 1: If the IDU is configured with wired control, set P45 to reset IDU project number through one key function.

Method 2: If the IDU is configured with lamp board, use the special control YV1L1 to set P45 and reset IDU project number through one key function.

Method 3: On the AP1 of the master ODU, press and hold SW5 for 10 seconds at least to clear all project numbers of the IDUs and then redistribute project numbers. Other parameters are kept unchanged.

#### 3.1.2.4 Cautions on Replacement of Slave IDU AP1

If the AP1 of a slave IDU needs to be replaced, after it is powered on, “Project number conflict (C5)” alarm may be reported. Refer to section 3.1.2.3 “Cautions on Replacement of Master IDU AP1” to address the issue.

### 3.1.3 Cautions on Wired Control Replacement

#### 3.1.3.1. Cautions on Wired Control XK46 Replacement

(1) If the wired control to be replaced controls only one IDU, directly replace the control.

(2) If the wired control to be replaced controls multiple IDUs, perform the steps below first:

Set the wired control parameter “P14” to change the number of managed IDUs to the actual quantity the control manages. For example, if the wired control manages 3 IDUs, set this parameter to 3. If you keep the default value 1, the LCD displays L9 (as shown in the figure below).

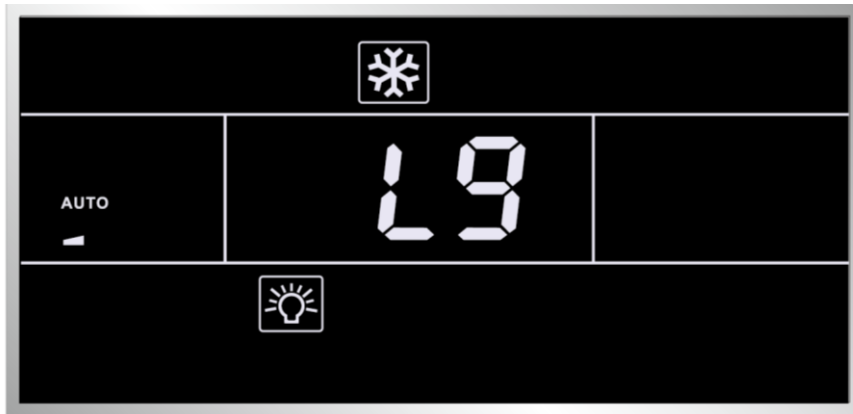

(3) If there are two wired controls controlling one or multiple IDUs, perform the steps below first:

Set the wired control parameter “P13” to change the address of one control to 01 (master) and that of the other control to 02 (slave); otherwise, a CP (multiple master wired controls) fault alarm will be reported (as shown in the figure below).

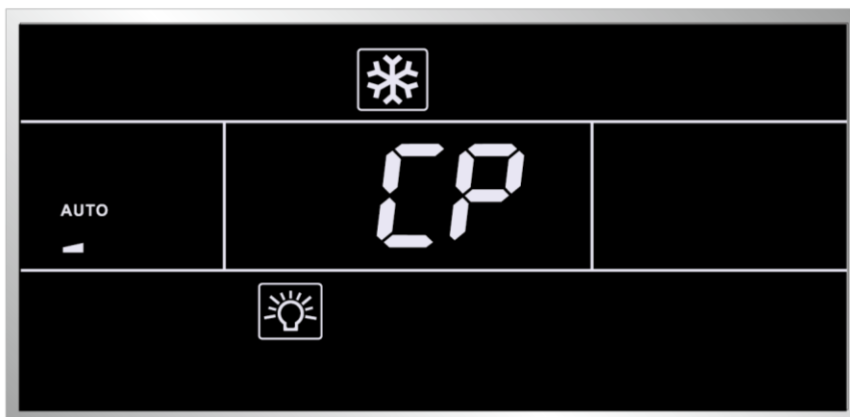

After setting, the LCD displays the  icon, as shown in the figure below.



Note: All wired controls are set to master wired controls by default.

(4) If the AP1 of the master IDU is replaced,

Reset the master IDU through the wired control; otherwise, the LCD displays L7 (no master IDU). There are two methods to set the IDU:

① In shut mode, press and hold the “MASTER” button for 5 seconds and set the IDU corresponding to this wired control to a master IDU. After setting, the “Main” icon is highlighted.

② Set the wired control parameter “P10” to 1.

### 3.1.3.2. Cautions on Wired Control XK49 Replacement

To replace the wired control XK49, in addition to the preceding handling steps specific for XK46, you should also configure access control.

(1) If the wired control does not need an access control system, set switch “1” for DIP S1 at the bottom of the wired control to digital end (neglect switch “2”).

(2) If the wired control needs an access control system, set switch “1” for DIP S1 at the bottom of the wired control to ON (neglect switch “2”) and connect the access control card interface to ports N and L or ports VCC and GND of the wiring terminal. The following should be noted:

① Ports N and L are power interfaces of 100-240V~50/60Hz access control.

② Ports VCC and GND are power interfaces of DC 5-24V access control.

③ Either of them can be selected at one time.

# 3.2 Compressor Replacement and Cautions

## 3.2.1 Determining Compressor Fault

3.2.1.1 Precondition: Units can be normally started.

Step 1:

If units can be normally started, start the units so as to measure line current of the faulty compressor. Use a pressure gauge to measure pressure of various valves and connect the gauge to a PC for viewing test data. Verify the current data in the figures below against the current recommended. For inverter compressors, current will be deviated 10% while rate of turn and operating condition vary.

① For inverter compressors E655DHD-65D2YG and E705DHD-72D2YG:

The figure below shows current curves that change with evaporating temperature and condensing temperature while the compressors work at 30 Hz.

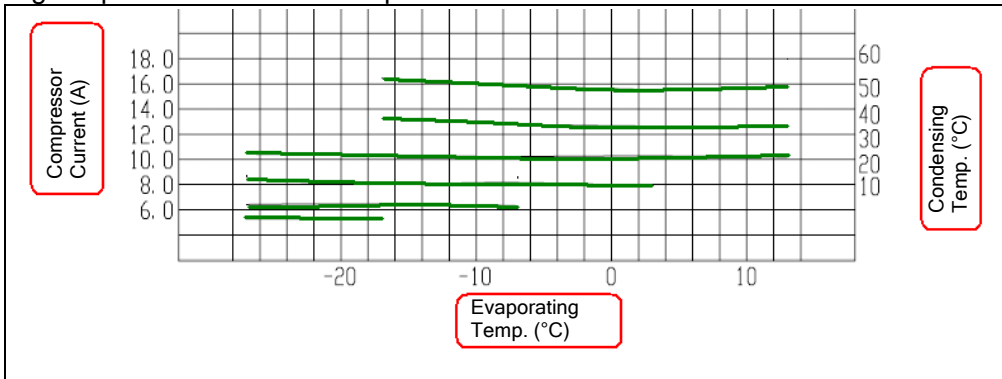

The figure below shows current curves that change with evaporating temperature and condensing temperature while the compressors work at 60 Hz.

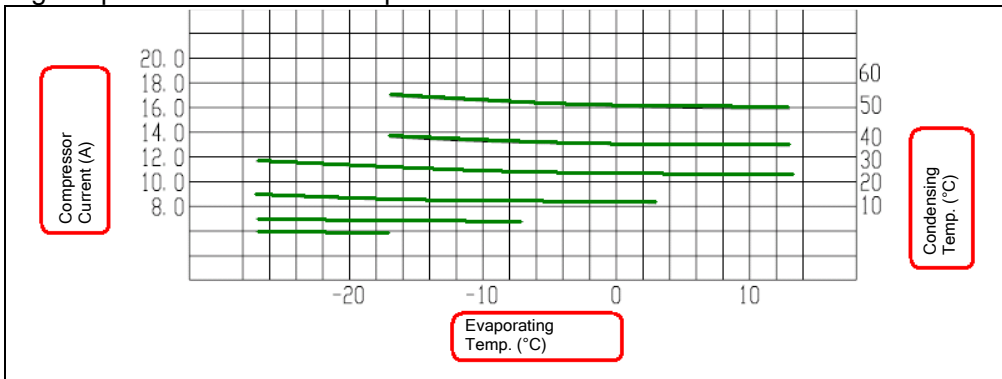

The figure below shows current curves that change with evaporating temperature and condensing temperature while the compressors work at 90 Hz.

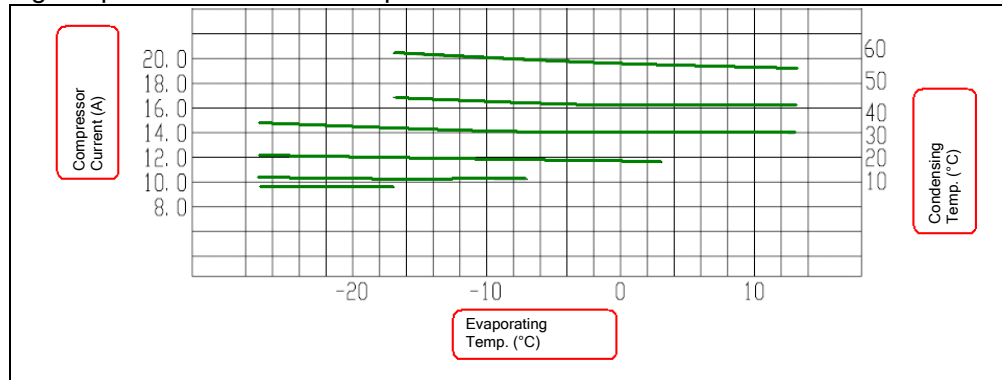

Note: You can infer from the preceding figures the current of the compressors operating at other frequency bands.

② For inverter compressor E405DHD-38D2YG:

The figure below shows current curves that change with evaporating temperature and condensing temperature while the compressor works at 30 Hz.

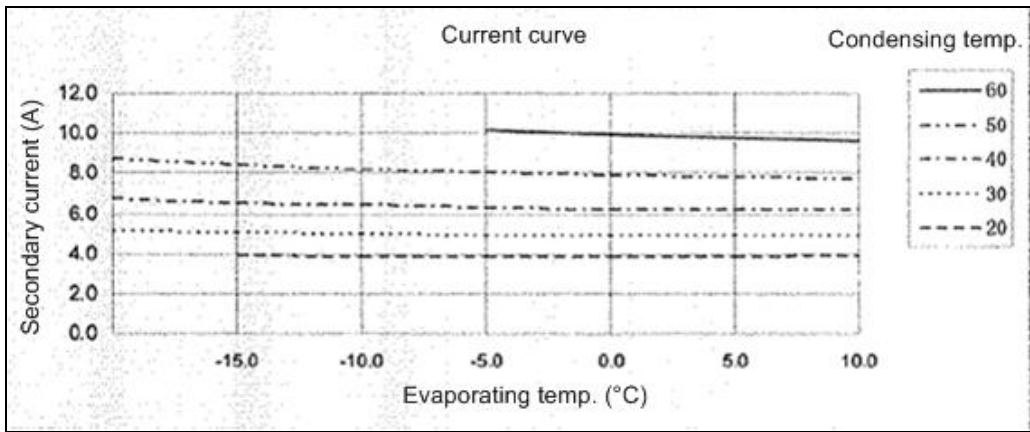

The figure below shows current curves that change with evaporating temperature and condensing temperature while the compressor works at 60 Hz.

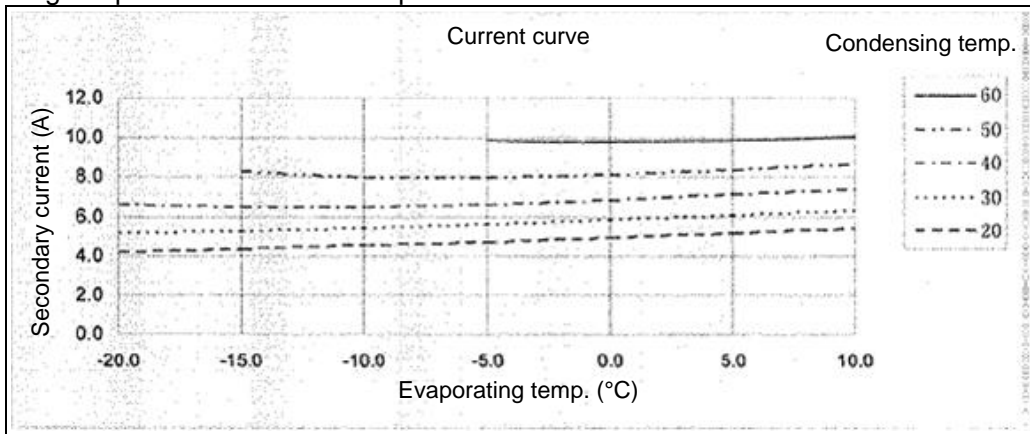

The figure below shows current curves that change with evaporating temperature and condensing temperature while the compressor works at 90 Hz.

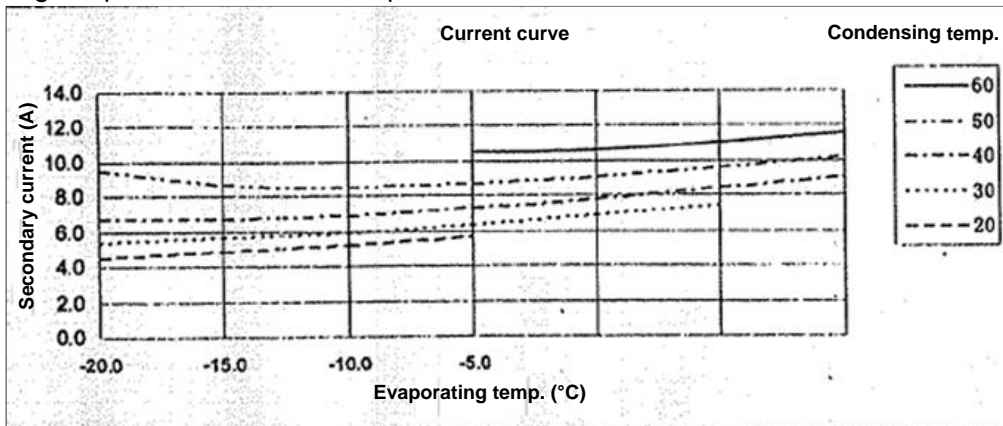

③For inverter compressor E656DHD-65D2YG:

The figure below shows current curves that change with evaporating temperature and condensing temperature while the compressors work at 30 Hz.

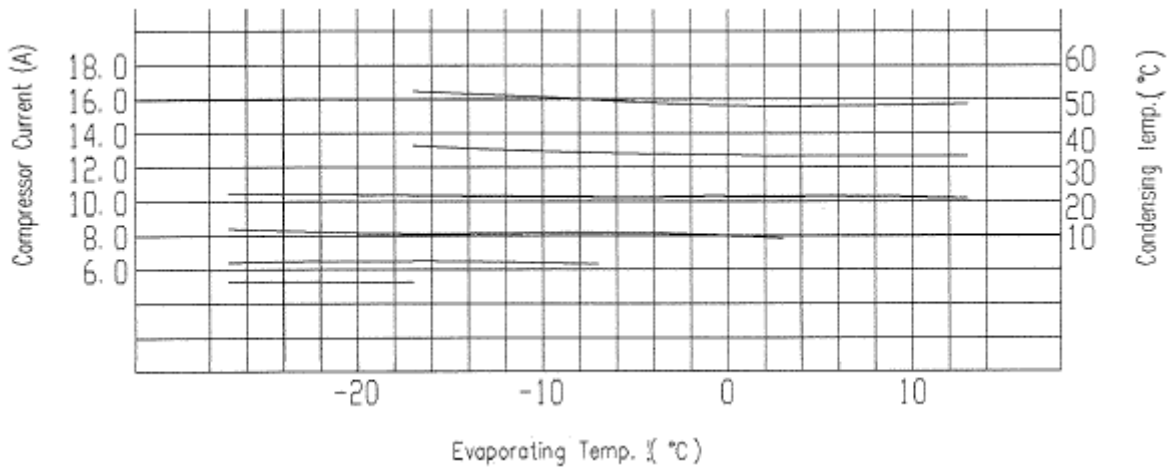

The figure below shows current curves that change with evaporating temperature and condensing temperature while the compressor works at 60 Hz.

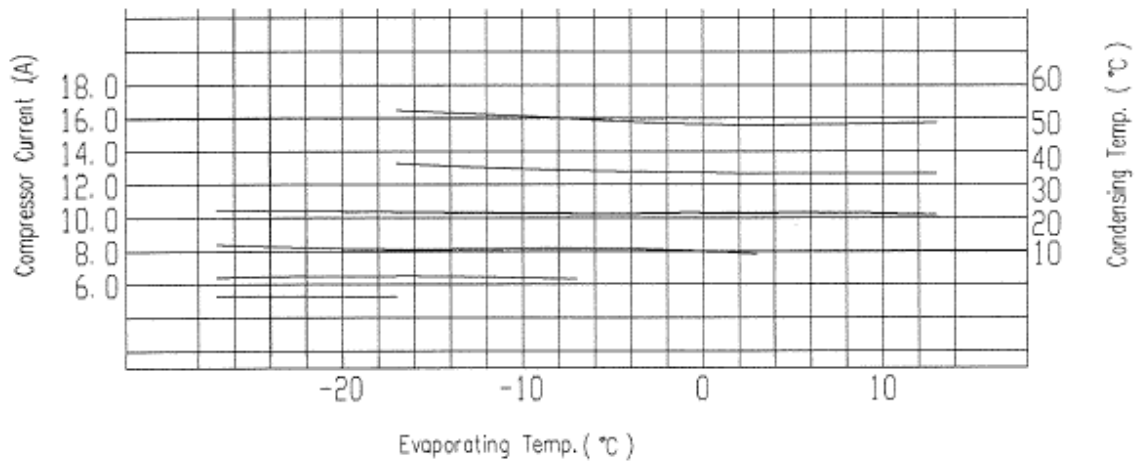

The figure below shows current curves that change with evaporating temperature and condensing temperature while the compressor works at 90 Hz.

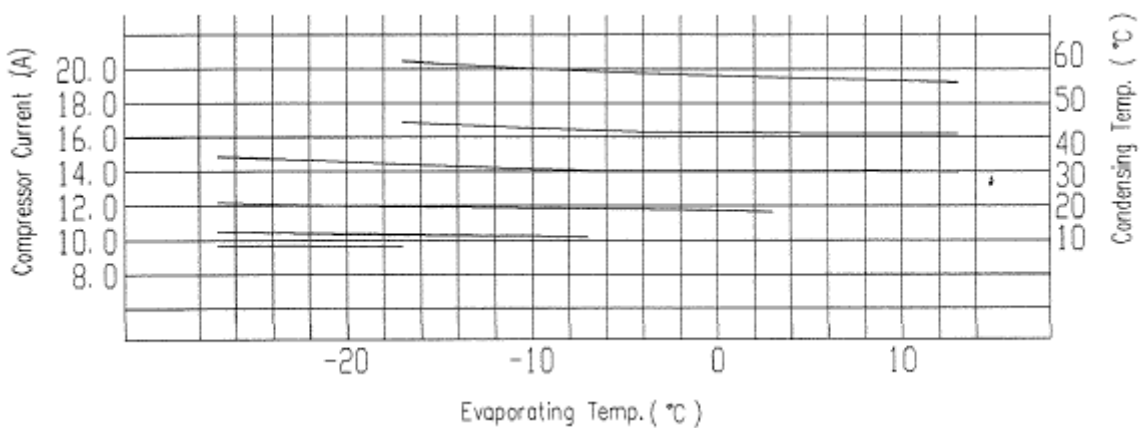

Note: You can infer from the preceding figures the current of the compressor operating at other frequency bands.

Step 2:

Check whether the compressor sounds sharp or rubs. Compare the sound of the faulty compressor with that of normal ones.

Step 3:

Check whether the electric expansion valves of ODUs and the 4-way valves act, and whether the oil return pipes and oil balance valves 1 and 2 are normal. Touch the pipelines next to the return capillary tubes to check whether there is oil flowing.

Check method for each part:

① Electric expansion valve: This valve will reset for each power-on or power-off action. Touch



the valve and you will feel its vibration during the reset action. A crack sound will be heard as well.

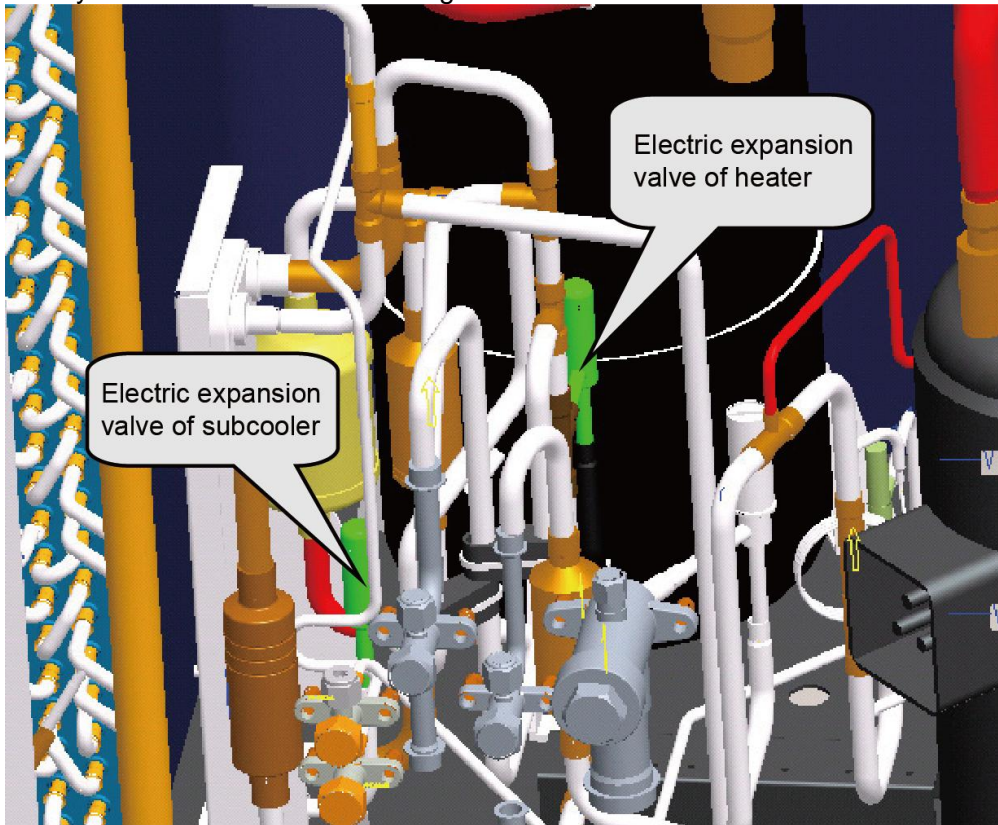

Description of electric expansion valve:

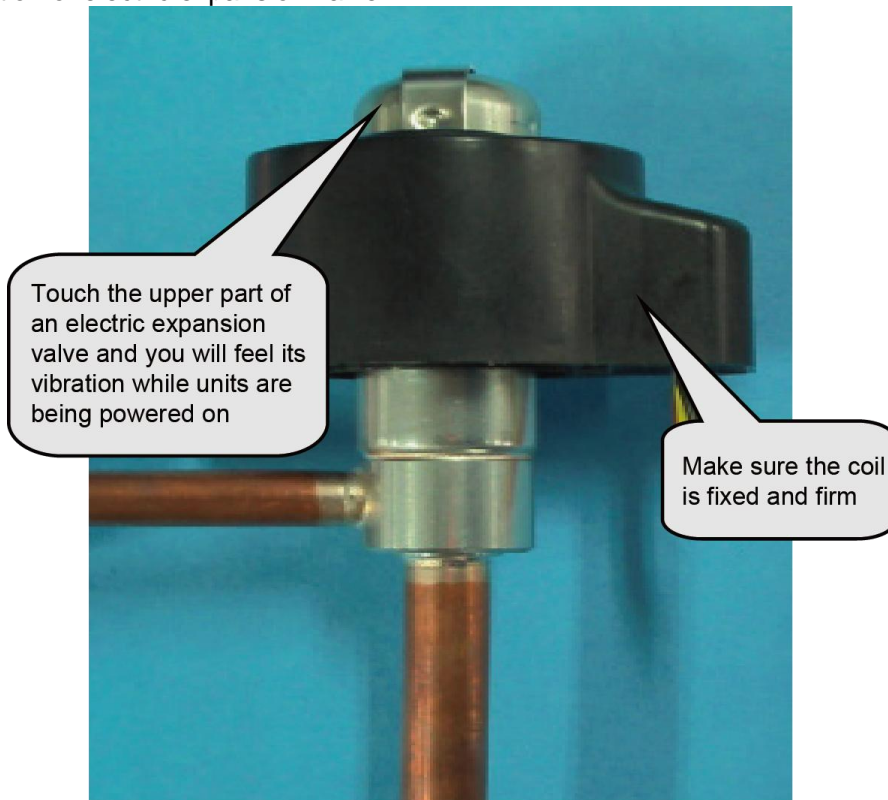

②Four-way valve: While this valve is normally running, the four copper pipes connected to it will suffer different temperature. When a unit switches to act the valve, you will feel obvious vibration and hear sound.

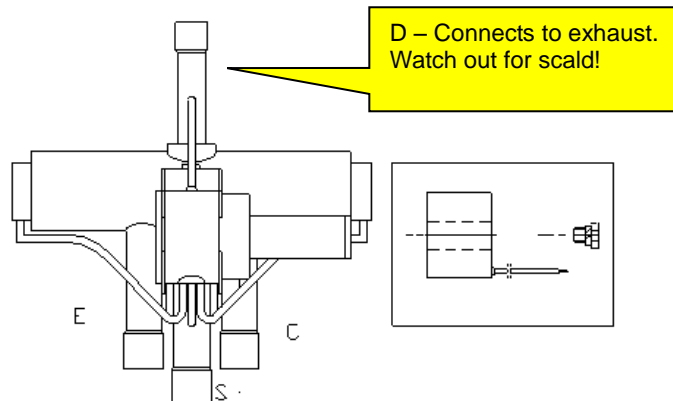
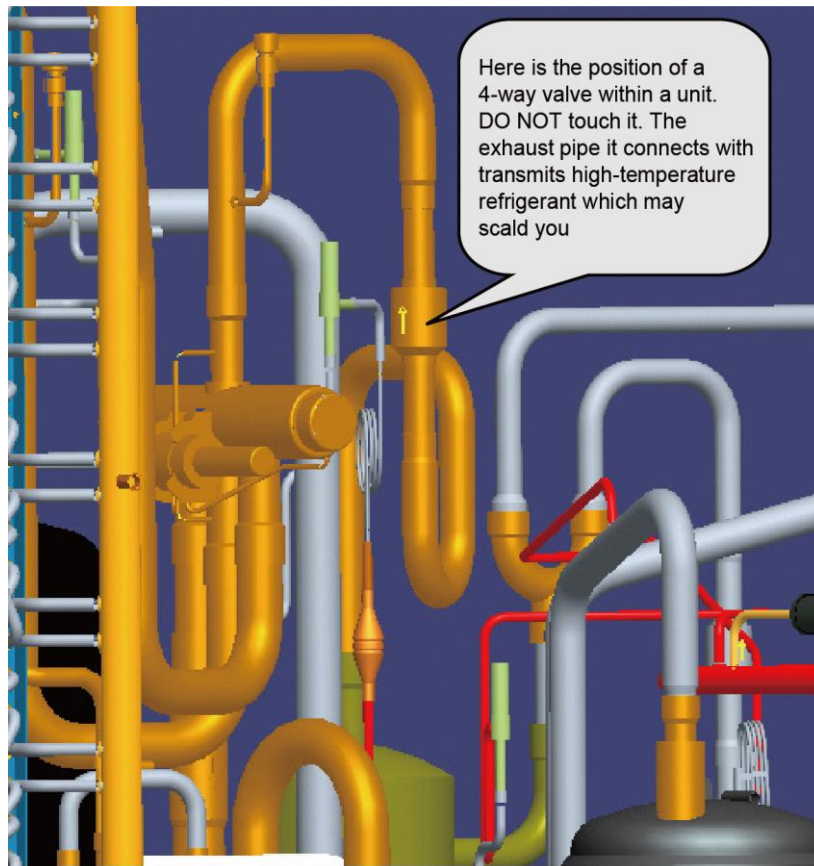

Labels on the 4-way valve and their meanings: D – connects to exhaust; E – connects to IDU evaporator; S – connects to intake of gas separator; C – connects to condenser. When the system is cooling, the pipe at side C works at high pressure high temperature, the pipes at sides E and S work at low pressure low temperature; when the system is heating, the pipe at side E works at high pressure high temperature, the pipes at sides C and S work at low pressure low temperature. The pipe at side D connects to exhaust and it is always working at high pressure high temperature. When units are starting, defrosting, or returning oil, the valve will vibrate obviously. DO NOT touch the pipe; or, you may be scalded.

③Oil balance solenoid valve: This valve can be operated based on its state that is shown through the monitoring software and actual situation. When this valve is opened, the coil will be heated and lubricant at both sides of the valve flows.



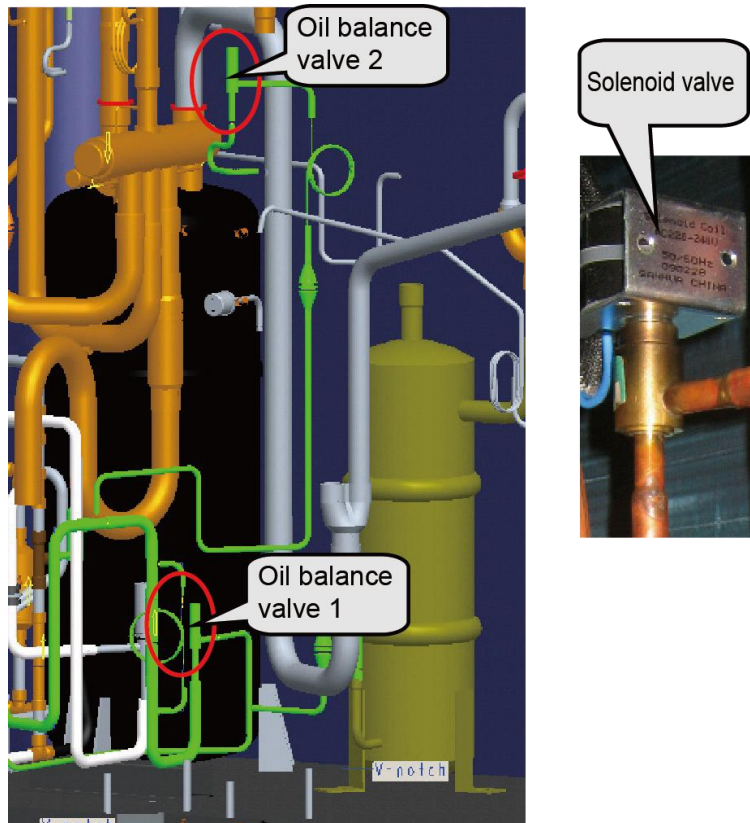

**Step 4:**

Test the compressor drive, namely the IPM module, to see whether it is normal.

1. Disconnect the power supply. Five minutes later, remove the line of the faulty compressor.

2. Set a multimeter to gear diode. As shown in the figure below, put the black test probe to pad P (on the left of pad U (BL)) and the red test probe to pad U (BL) (make sure the moisture proof tape is removed). In normal cases, the multimeter should read  $0.39 \pm 0.3$  V. If it is "0" or infinitely great, the IPM module is faulty.

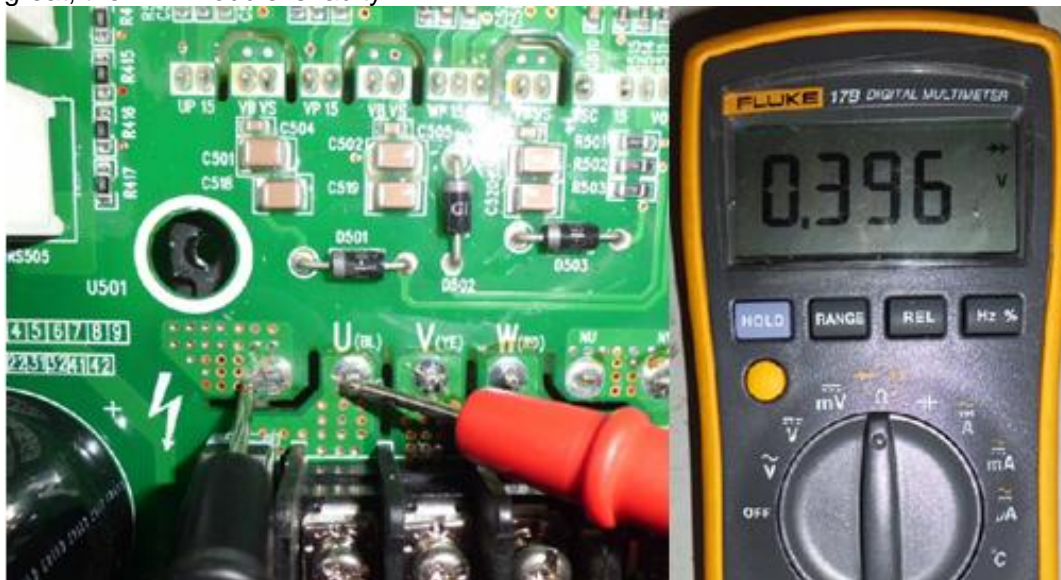

3. As shown in the figure below, put the black test probe to pad P and the red test probe to pad V (YE) (make sure the moisture proof tape is removed). In normal cases, the multimeter should read  $0.39 \pm 0.3$  V. If it is "0" or infinitely great, the IPM module is faulty.

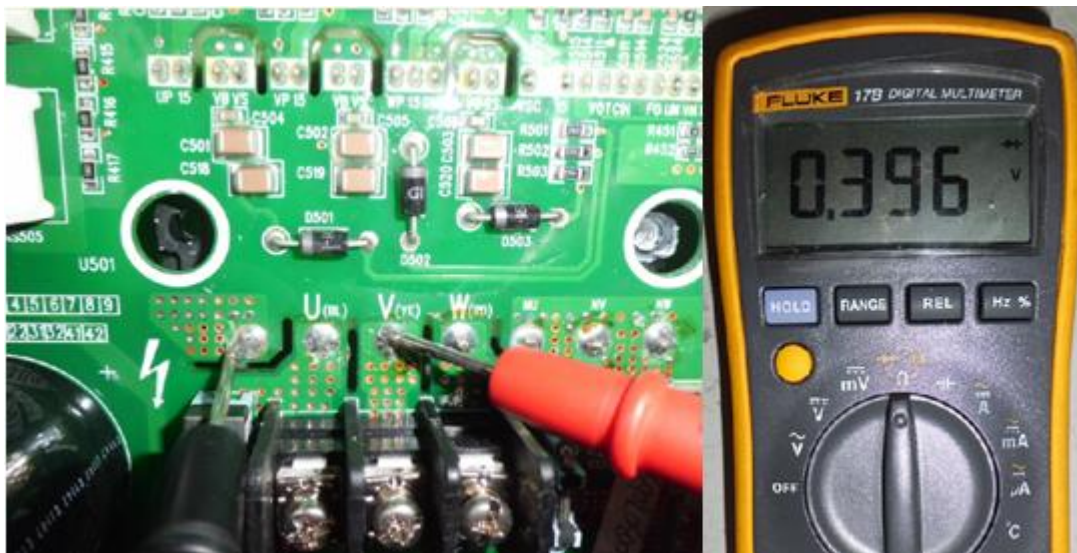

4. As shown in the figure below, put the black test probe to pad P and the red test probe to pad W (RD) (make sure the moisture proof tape is removed). In normal cases, the multimeter should read  $0.39\pm 0.3$  V. If it is "0" or infinitely great, the IPM module is faulty.

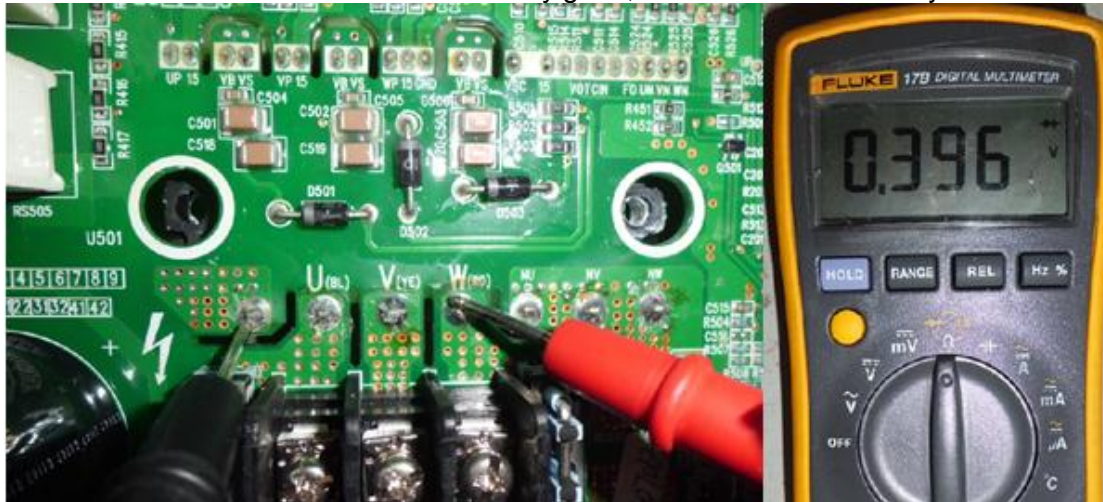

5. As shown in the figure below, put the black test probe to pad U (BL) and the red test probe to pad NU (make sure the moisture proof tape is removed). In normal cases, the multimeter should read  $0.39\pm 0.3$  V. If it is "0" or infinitely great, the IPM module is faulty.



6. As shown in the figure below, put the black test probe to pad V (YE) and the red test probe to pad NV (make sure the moisture proof tape is removed). In normal cases, the multimeter should read  $0.39\pm 0.3$  V. If it is "0" or infinitely great, the IPM module is faulty.



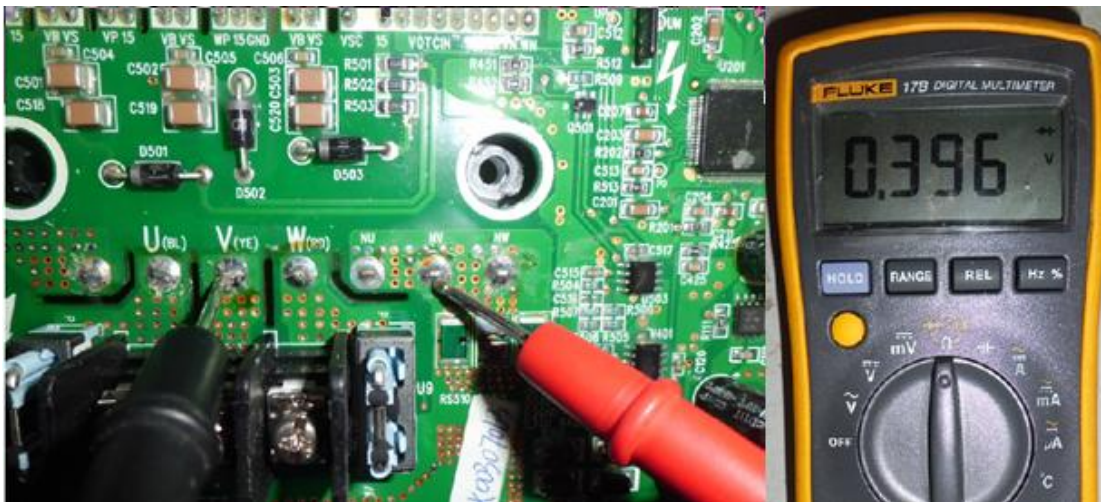

7. As shown in the figure below, put the black test probe to pad W (RD) and the red test probe to pad NW (make sure the moisture proof tape is removed). In normal cases, the multimeter should read  $0.39 \pm 0.3$  V. If it is "0" or infinitely great, the IPM module is faulty.



3.2.1.2 Precondition: Units cannot be normally started.

Step 1:

Disconnect the power supply of the units and open the electric junction box of the compressor to see whether wiring of the compressor is intact.

Step 2:

Measure resistance between two wiring terminals (U, V, W). The resistance value range should be  $0.5 \sim 2.0 \Omega$ .

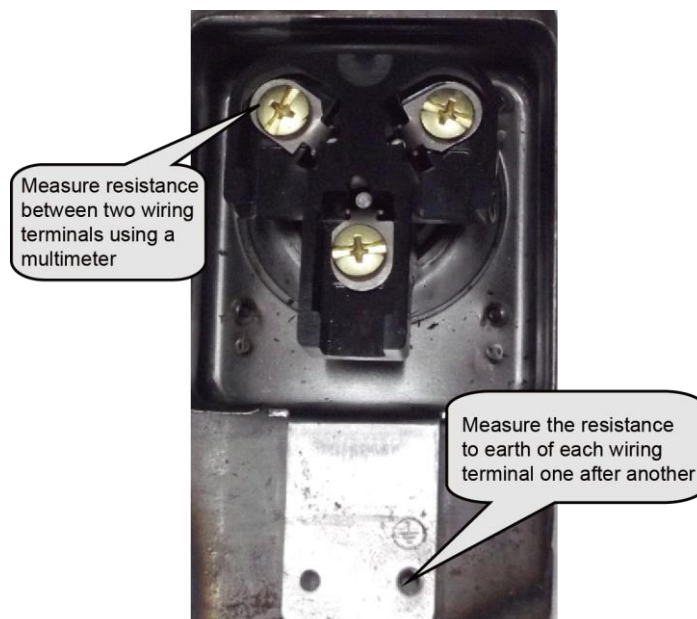

Measure the resistance to earth of each wiring terminal. The value should be 10 MΩ. If not, the compressor has an internal fault.

Step 3:

Check the solenoid valves of the system, include electric expansion valves, oil return valves, and oil balance valves. Refer to the preceding section for the test method.

Step 4:

Check the IPM module. Refer to the preceding section for the test method.

### 3.2.2. Compressor Replacement

Step 1: Disconnect power supply.

Turn off the power switch of the ODUs and disconnect the line of the power supply and the power line of the ODUs. Meanwhile, cover the power line with tape for insulation and put a warning sign beside the power switch to prevent electric shock.

Step 2: Check oil quality.

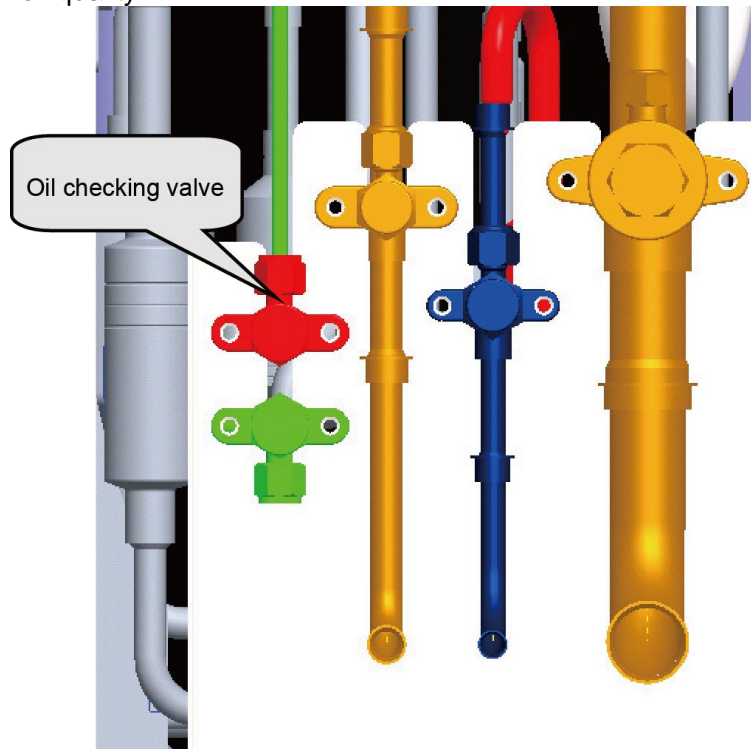

Before releasing the refrigerant, get some freezing oil through the oil checking valve. Connect a rubber hose to the oil checking valve at one end and a glass container at the other end. Open the oil checking valve. Control oil flow speed. Since the oil is a mixture of volatile refrigerant and lubricant, DO NOT cover the container; or it may explode.

After the lubricant is fully gasified, record the volume of oil.

Step 3: Release refrigerant.

Refrigerant should be released from the high pressure side and low pressure side at the same time. If it is released from one side only, the scroll is sealed, causing the refrigerant to fail to be released completely. Control the release speed (it is expected to release for 12 hours or more). If too fast, massive lubricant will be discharged with the refrigerant. Make sure to mark the valves.

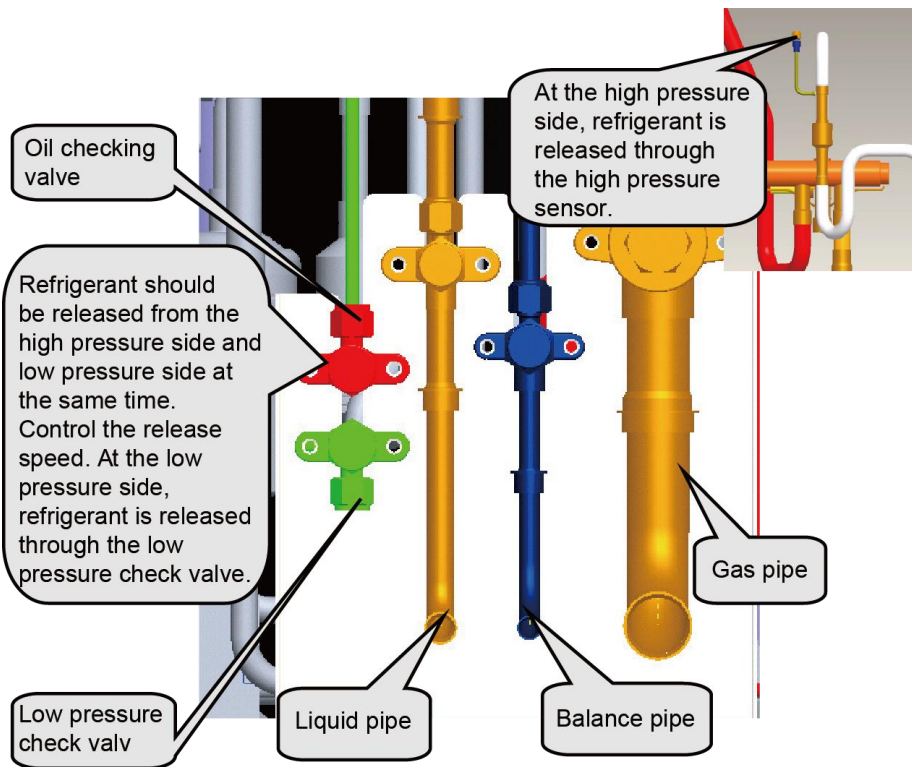

**Step 4: Remove faulty compressors.**

Confirm faulty compressors, including number of faulty ones, compressor position, and model.

If the inverter compressor is damaged, or the oil of the fixed speed compressor is contaminated, remove the inverter compressor. The procedure is as follows:

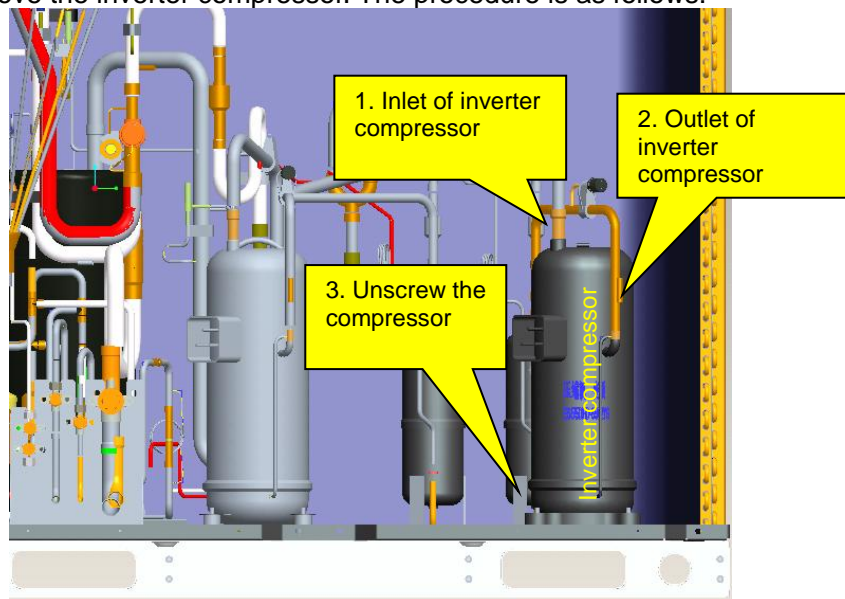

After the compressor and oil separator are removed, check oil quality. If oils are contaminated, replace the compressor, oil separator, and gas/liquid separator. If oil changes to black, check oils of other modular units. The check procedure is similar to the preceding.

**Note:** Before replacing the faulty compressors, make sure to block their openings with tapes. They should be kept intact for further analysis.

**Step 5: Check system parts.**

If system oil is contaminated, check unit parts, including oil separator, gas/liquid separator, and storage tank.

① Check oil separator

Remove the oil separator. Tilt the separator to draw oil out into a container. Block the container for further factory inspection.



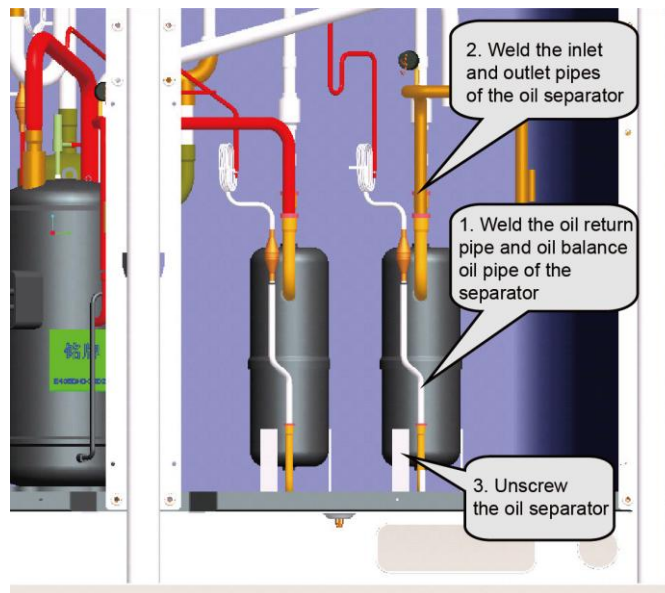

② Check oil balancer

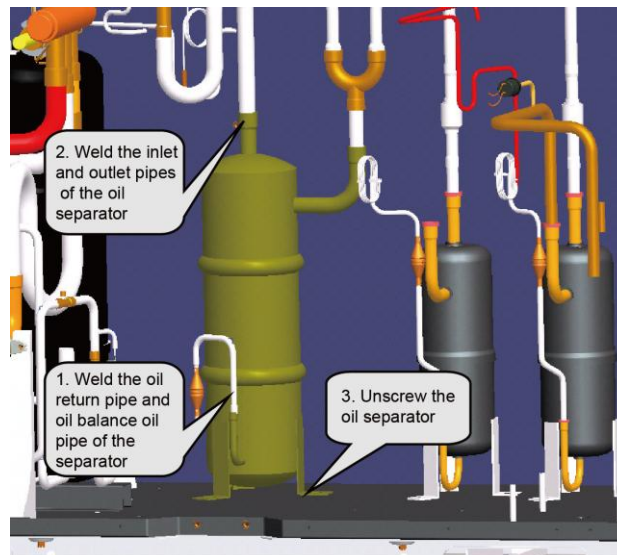

③ Check gas/liquid separator

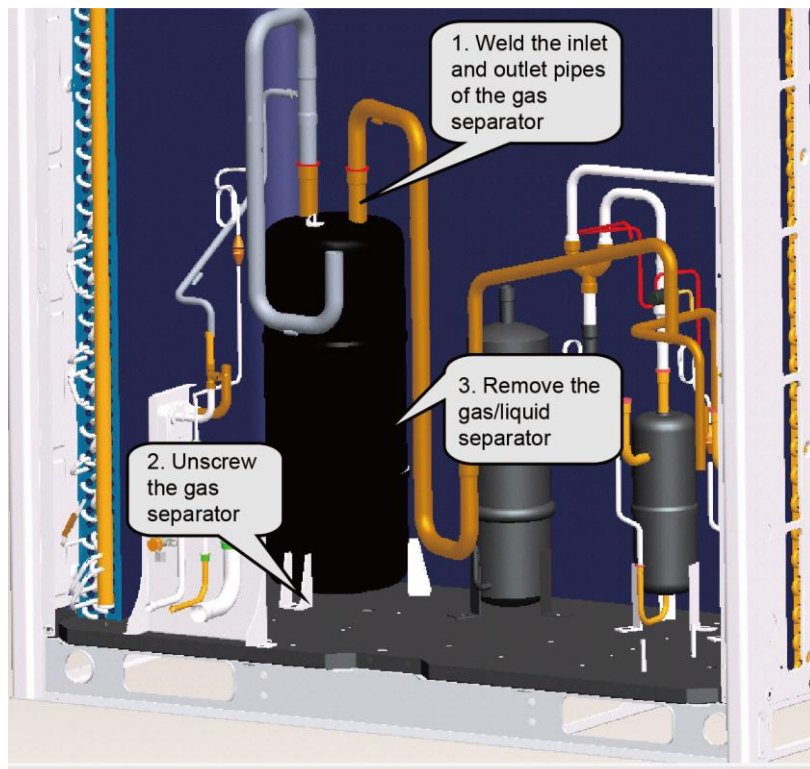

After the gas separator is taken out, check whether it contains impurities. The check procedure is as follows:

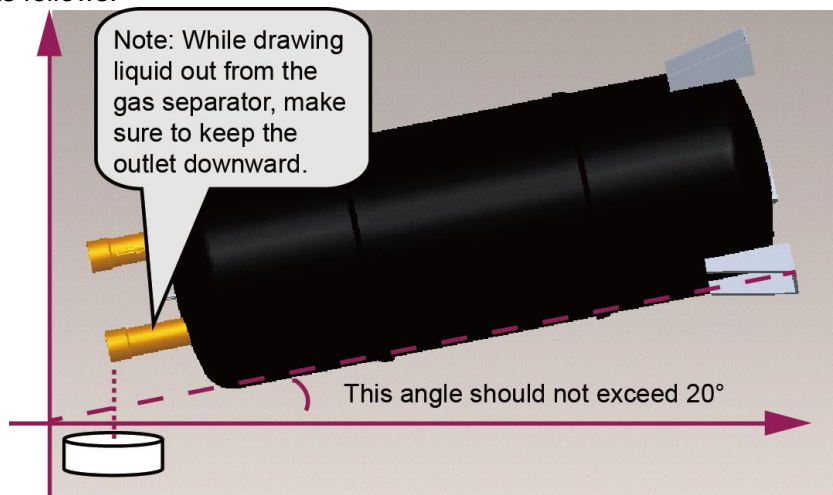

Use a glass container to hold the liquid. Check liquid impurities and colours and block the container for further factory inspection.

Note: If the compressor needs replacement, the gas/liquid separator needs replacement as well, regardless whether the separator contains impurities or has faults or not.

④ Check oil return pipes

Remove oil return pipes and balance pipes, and check oil volume and impurity.



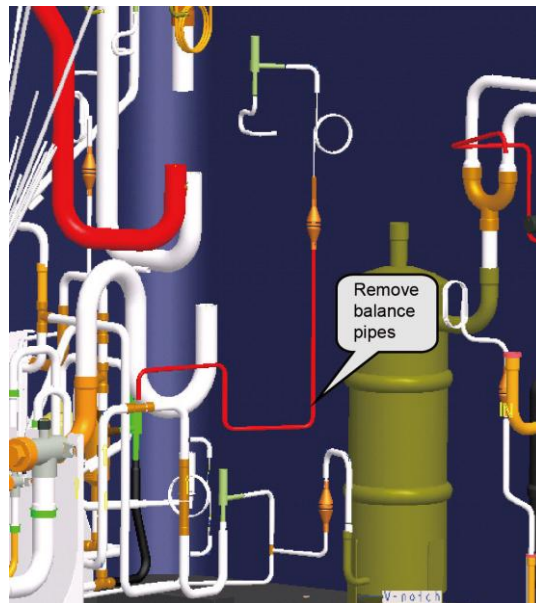
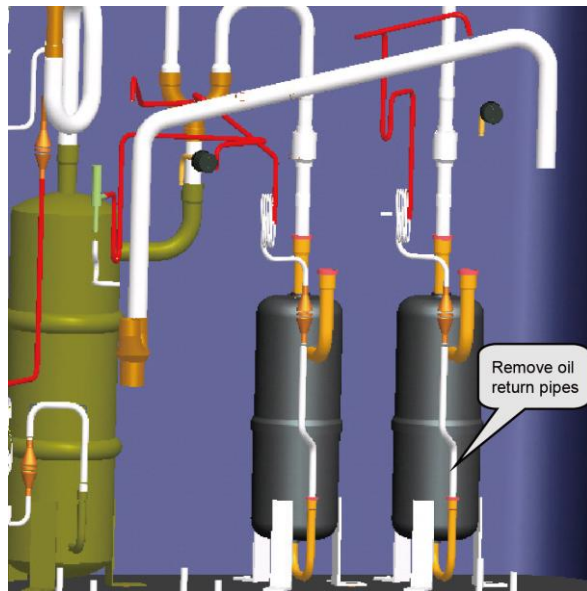

Note: Before replacing the faulty parts, make sure to block their openings with tapes. They should be kept intact for further analysis.

Note: Volumes of oils drawn out from the oil separator, gas separator, and oil balancer should be recorded. After faulty compressors and parts are replaced, you should fill new oils of equivalent amount into the compressors and parts.

Step 6: Clear pipeline system.

Check pipelines for abnormalities. Charge nitrogen into the main pipeline and clear the pipeline system.

① Clear the balance pipes

Components of oil balance valve 1:

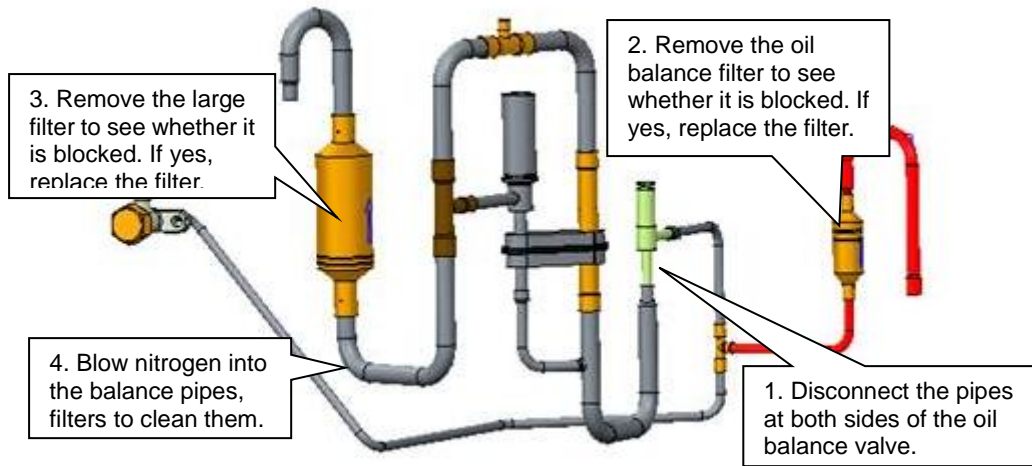

Components of oil balance valve 2:

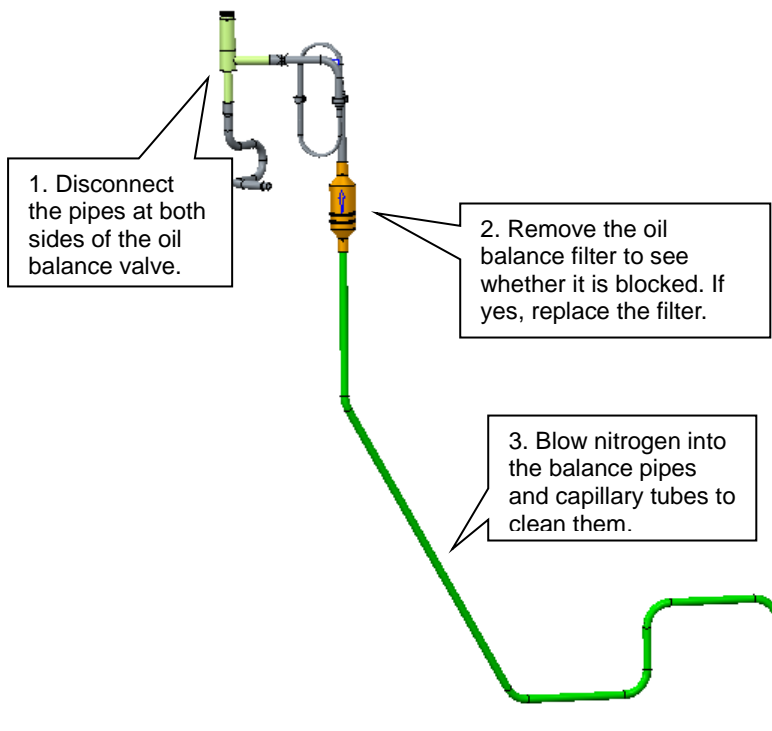

② Clear oil return pipes

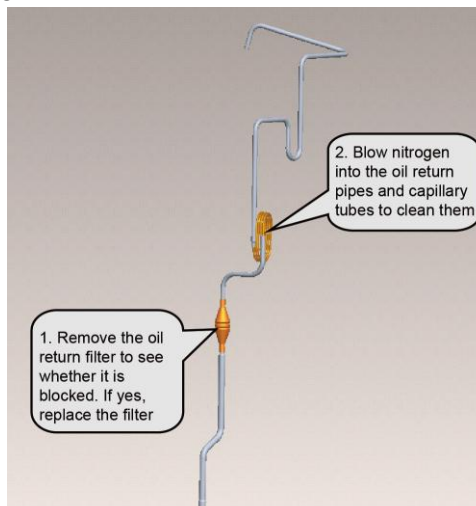

③ Clear liquid pipe filters

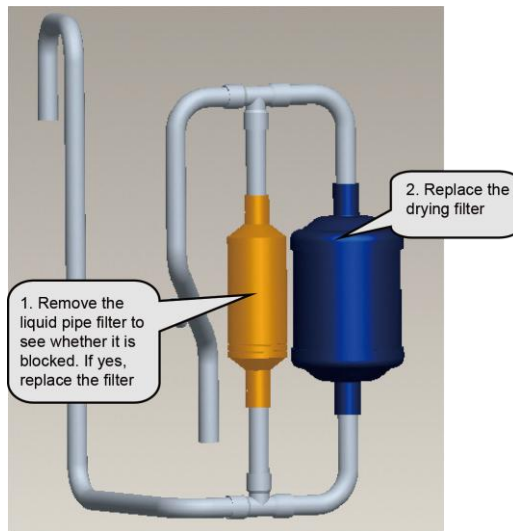

For other pipeline parts, clear them based on actual situation. If you do not replace the parts immediately, make sure to block the pipes with tapes, preventing air moistures and impurities from contaminating them.

**Step 7: Preparations.**

**1. Prepare new parts.**

In the course of moving compressors, do not lay them down or put them upside down. The tilt angle should be less than 30°. Make sure oil will not overflow from the oil balance opening. The inlet and outlet should be blocked. If the sealing rubber is not available, cover them with tape to prevent direct contact of oil and air.



Note: The new compressor must be consistent with the faulty one in model.



Check the rubbers for oil separator, gas separator, oil balancer, and drying filter. If they are lost during transportation, cover the parts with tape to keep the compressor dry and airtight inside.



Note: Compressor lubricant must be kept completely airtight. Hitachi compressors use special lubricant FVC68D whose moisture absorption capability is high. Requirements on air-tightness of these compressors are higher.

2. Prepare other materials.

(1) Prepare nitrogen. Prepare enough nitrogen. They will be used during welding. Nitrogen pressure should be 2.0 MPa at least.

(2) Prepare welding rods. In addition to ordinary welding rods, you should also prepare special welding rods (containing 5% or more silver). Compressors' inlets and outlets are made of copper plated steels, which require special welding rods and materials.

(3) Prepare gases for welding. Oxygen and acetylene of proper amount should be determined with consideration of actual welding positions. Try to finish the welding task once. Avoid repeated welding.

(4) Prepare tools, including hexagon, diagonal pliers, combination pliers, needle nose pliers, multimeter, pressure gauge, Phillips screwdriver, flathead screwdriver, wrenches (at least two), PVC insulation tape, and tielines (multiple).

Step 8: Install a new gas/liquid separator.

Note: If a faulty compressor needs replacement, the gas/liquid separator needs replacement as well. This is to avoid abnormality from happening inside the gas separator, and affecting system safety and reliability.

Put the gas/liquid separator on a chassis and connect the inlet pipe of the gas separator with the outlet pipe. Then, connect the pipe to a nitrogen source. The nitrogen source can be

connected based on actual situation, for example, you can add a bypass interface or directly connect the nitrogen source to the inlet/outlet pipe. If the pipe is big, cover it with tape as well. Make sure nitrogen can smoothly flow through the gas separator.

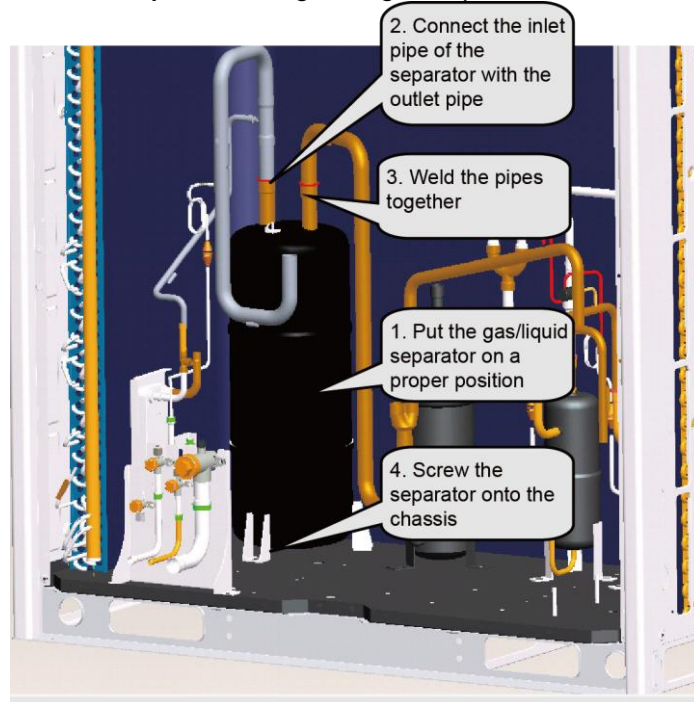

Step 9: Install a new oil balancer.

The original oil balancer, if it is found to have no impurities or other objects, can be used further more. This part serves as a container and it does not have complex structure. However, if it contains impurities or other objects, replace it. This is because a dirty oil balancer cannot be thoroughly cleaned.

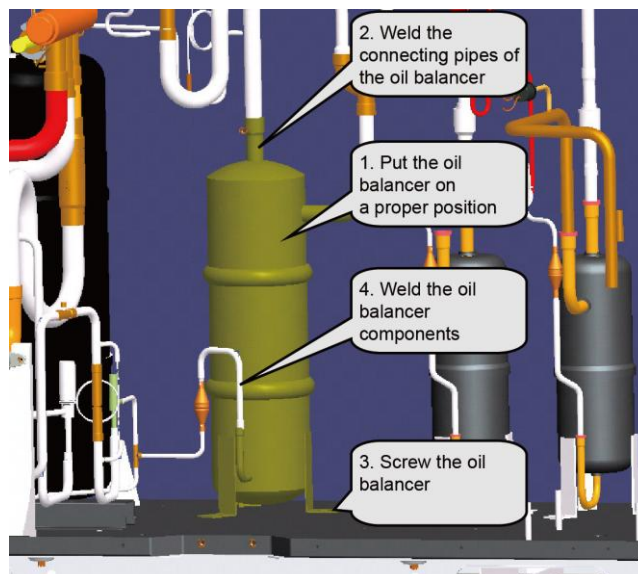

Step 10: Install a new oil separator.

If the original oil separator contains impurities inside, replace it.



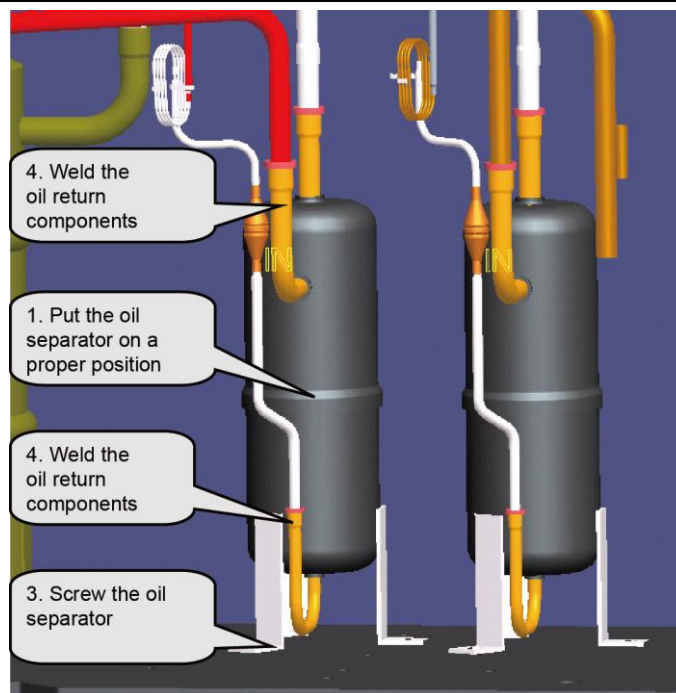

Step 11: Install a new compressor.

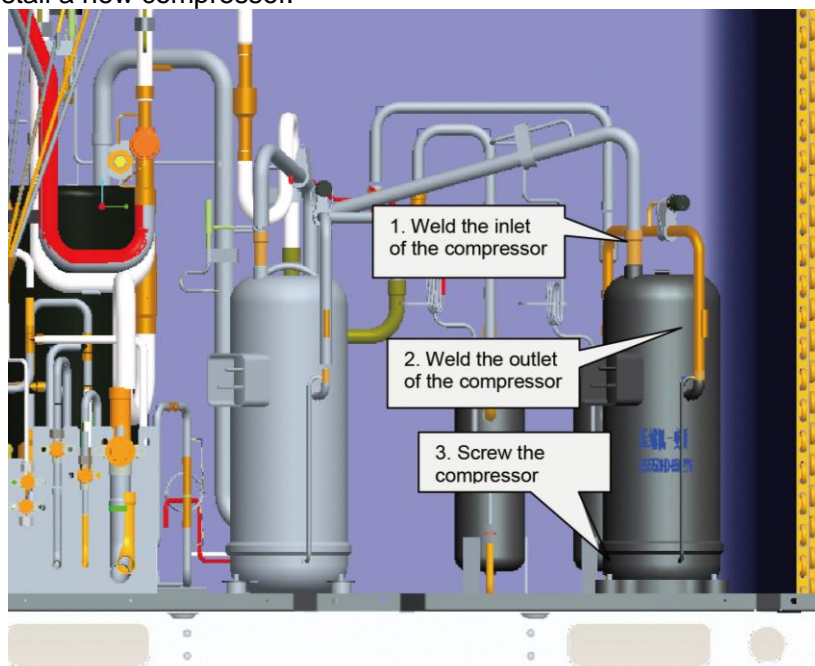

Note: Keep wiring identical to factory installation. Control varies with compressors. Wrong wiring or inverse connection of the compressors may cause damage to units.

Cautions on replacement of compressors:

- ① Before installing new compressors, remove the sealing rubbers and weld the compressors with corresponding pipes. During welding, charge nitrogen into the pipes. Since compressors' suction and discharge pipes are made of copper plated steels, you need to prepare special welding rods (containing 5% or more silver). Welding clearance should be controlled within 0.1~0.3mm, avoiding blockage or loose welding. During welding, control pipe openings from being over-heated.
- ② After the pipeline system is welded, use special supports and bolts to fix the compressors, ensuring stability of the compressors during running.
- ③ Power lines of the compressors should be wired following the factory installation. You can refer to the wiring diagram. Phase sequence error is not allowed.

Step 12: System check.

1. Check welding joints for abnormalities.
2. Charge nitrogen into the system for leakage detection. If you are maintaining ODUs and the IDU system is normal, you can charge nitrogen into the ODU system only. Note that nitrogen

should be charged from both the high pressure side and low pressure side. You are advised to charge through all valves. Nitrogen pressure should be larger than 20 kgf. Then, charge soapsuds into the system and check specially the weld joints for leakage.

3. Finally, charge nitrogen into the system again for pressure check. Close all valves and keep system pressure up to 25 kgf for more than 12 hours. If the pressure remains unchanged, you can extract all air. Otherwise, you should find the leakage points first.

While determining system pressure change, take temperature into consideration. For 1°C temperature change, pressure will change by 0.01 MPa accordingly. Suppose that nitrogen pressure reaches 2.5 MPa at 30°C, 12 hours later, temperature decreases to 25°C and pressure decreases to 2.43 MPa accordingly. The system is regarded qualified despite the pressure decrease.

**Step 13: Fill lubricant.**

When a compressor is replaced, we should clear all lubricant of the system and determine fill amount by referring to the basic parameters of units.

For example:

For GMV-280WM/B-X unit, one compressor is replaced; we should draw out all lubricant of separator and other accessories in the system; pipes have been charged with nitrogen for cleaning. So there is a little of residual lubricant inside the system. You are advised to add 3.5L new lubricant into the system (determined by referring to the basic parameters of units ).

Specific procedure is as follows:

- ① GMV5 series units use FVC68D or FV-68H lubricant. Make sure to confirm the trademark of the lubricant first. Lubricant of other trademarks is not allowed.
- ② Open all valves and extract air for 30 minutes or longer.
- ③ Connect a rubber hose to the oil checking valve at one end. Open the container that holds lubricant and pour lubricant into a measuring glass. If the glass is too small to hold the lubricant of a required amount, measure the lubricant portion by portion. Record volume of each portion and then put the other end of the rubber hose into the glass.
- ④ Keep on extracting air and open the oil checking valve. The lubricant will be pressed into the low pressure side of units.
- ⑤ If the lubricant is added portion by portion, close the oil checking valve first and then measure another portion of lubricant. In the course of repeated measuring and adding, keep the extraction action.
- ⑥ After a required amount of lubricant is added, close the oil checking valve to ensure tightness.

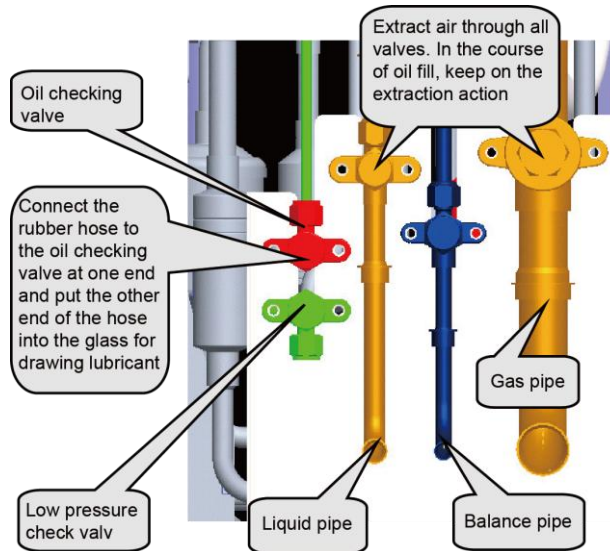

Note: Lubricant is of great importance to the normal running of compressors. You should follow Gree's requirement to add qualified lubricant of the specified trademark and ensure properness of fill amount.

**Step 14: Vacuum-pump.**

After lubricant is added, keep on extracting air through a vacuum pump till the internal pressure reaches the absolute pressure 0 kgf/cm<sup>2</sup> and the pressure gauge reads -1 kgf/cm<sup>2</sup>. This is to ensure that moistures inside the pipeline system are completely vaporized.

Vacuum pumps of the specifications below are recommended:

Type	Max. Discharge Rate	Purpose
------	---------------------	---------

		For air discharge	For vacuum drying
Lubricant driven pump	100 L/min	Applicable	Applicable
Lubricant free pump	50 L/min	Applicable	Applicable

Open all valves in order that the vacuum pump extracts air through all the valves, during which, connect the units to a pressure gauge. When the internal pressure reaches 0 kgf/cm<sup>2</sup> and the pressure gauge reads -1 kgf/cm<sup>2</sup>, keep on the extraction action for 0.5~1.0 hour more. Finally, turn off the rotary switch of the gauge and close the pump. One hour later, if the pressure remains the same, fill refrigerant. If the pressure increases to 0.1 kgf/cm<sup>2</sup> or higher, conduct leakage check again.

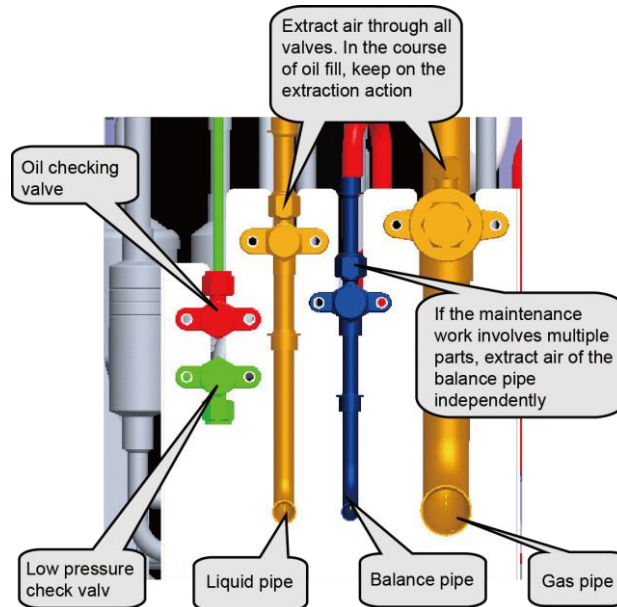

**Step 15: Fill refrigerant.**

Before filling refrigerant, check its manufacturer, package, and print information. Besides, check refrigerant pressure and quality against the saturation pressure / temperature list.

1. Measure and check the pressure of the entire refrigerant product against the saturation pressure / temperature list. Verify temperature parameter. If the difference between the actual temperature and the parameter value is 3°C or more, the refrigerant quality is unsatisfactory.

2. If the refrigerant is proved satisfactory, fill refrigerant of the combined amount of the rated amount (specified on the nameplate) and the calculated refrigerant loss amount.

For a multi-modular unit system, if only the refrigerant of an ODU is drawn out, add 80% refrigerant of the rated fill amount (specified on the nameplate of the ODU) and start the system for a debugging test.

**Step 16: Install electric parts.**

Install the electric box and connect various parts to the electric box by referring to the marks made beforehand and the wiring diagram on the back of the box. Wire the compressors and corresponding electric heating belts.

Note: Wires should be checked against the wiring diagram beforehand so that they can be connected correctly.

**Step 17: Start for debugging.**

Start the units and set them to run in refrigerating full-start, refrigerating single-start, heating full-start, and heating single-start modes respectively. Duration for each running mode should be 30 minutes at least. After the debug, analyze data and adjust the unit system, to ensure indexes of the entire system. For details about each index, please consult after-sale persons and technicians.



## 3.3 Cautions on Compressor Drive Replacement

1. Disconnect the power supply of the system. Set a multimeter to the AC voltage gear and measure voltage between two of the lines (L1, L2, L3, and N). The measuring result should be 0 V (sometimes, multimeters may be faulty and read false values). Set a mark beside the power supply for warning.
2. Measure compressor drive DC bus voltage between two wire terminals of P, U, V, W and N. Set the multimeter to the DC voltage gear and measure the voltage between P and N. The voltage should be lower than 36 V. If no multimeter is available, wait for 20 minutes before performing the steps below.

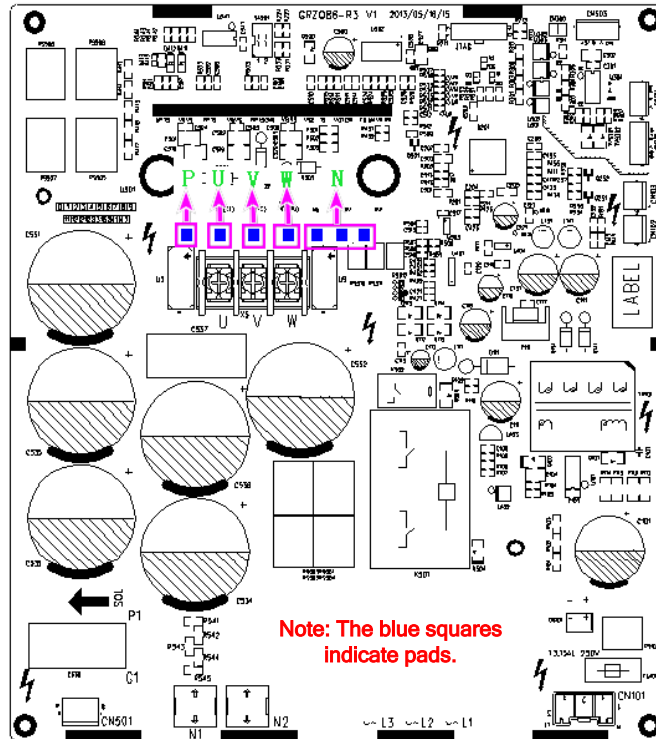

3. Disconnect all lines of the compressor drive, including: compressor line; communication line between the master unit and the drive; communication line between the compressor drive and fan drive; compressor drive output 18 VDC; bridge rectifier output P; bridge rectifier output N; compressor drive output 540 VDC; reactor's wiring terminal; bridge rectifier input AC inlead; compressor drive's mains terminal. See the figure below:

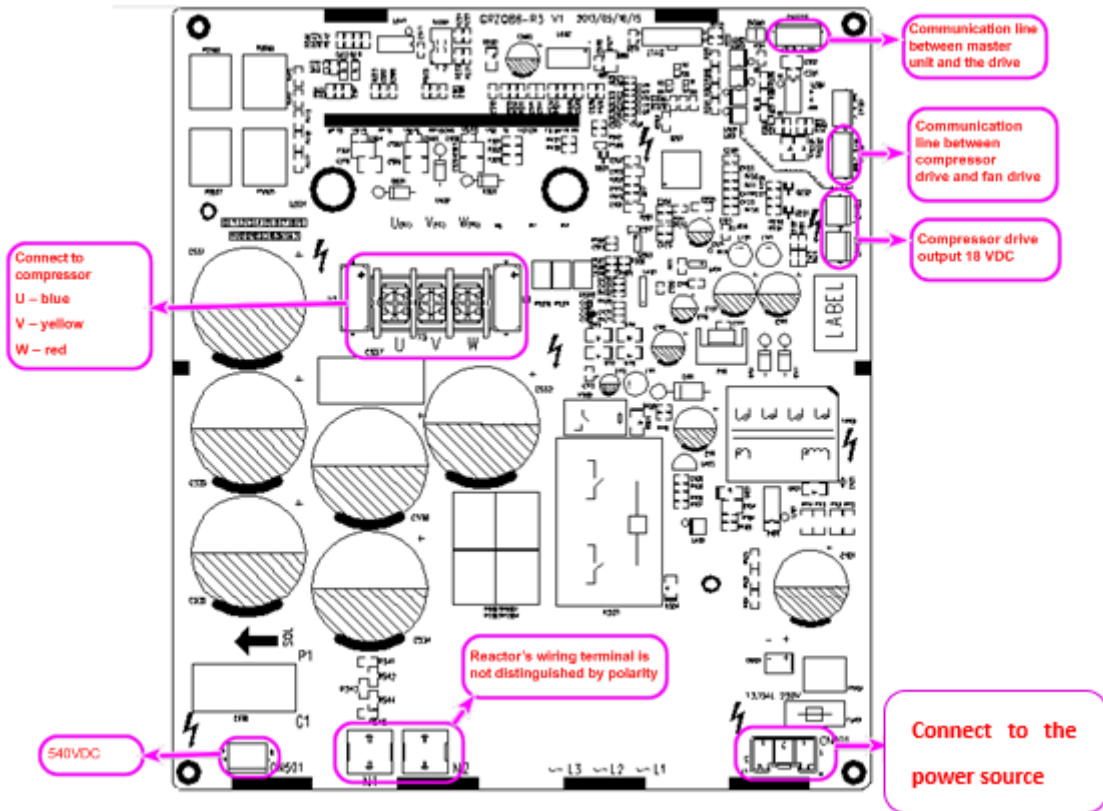

- Loosen the screws on the compressor drive, as shown in the figure below:

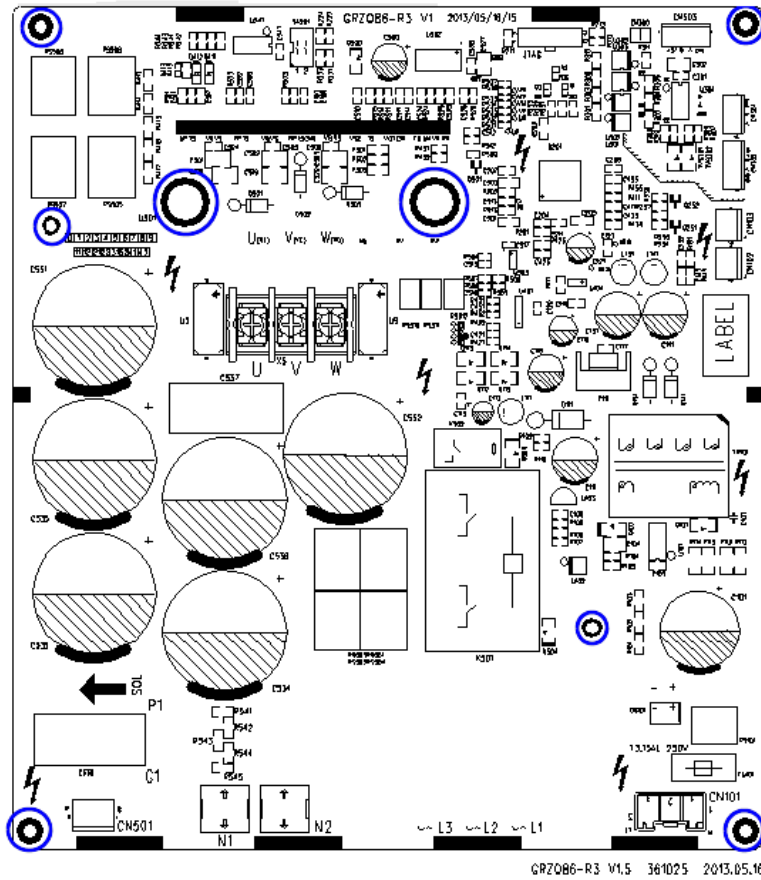

- Replace the compressor drive. Before the replacement, apply some silicone tape onto the IPM module.

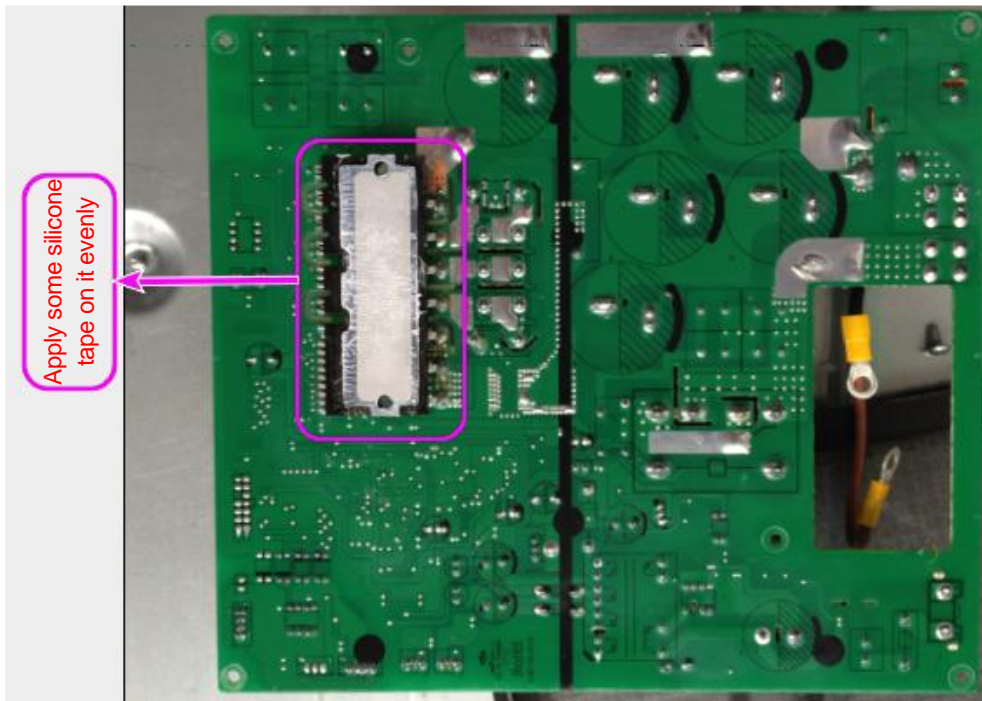

6. Install a new compressor drive, screw and wire it.

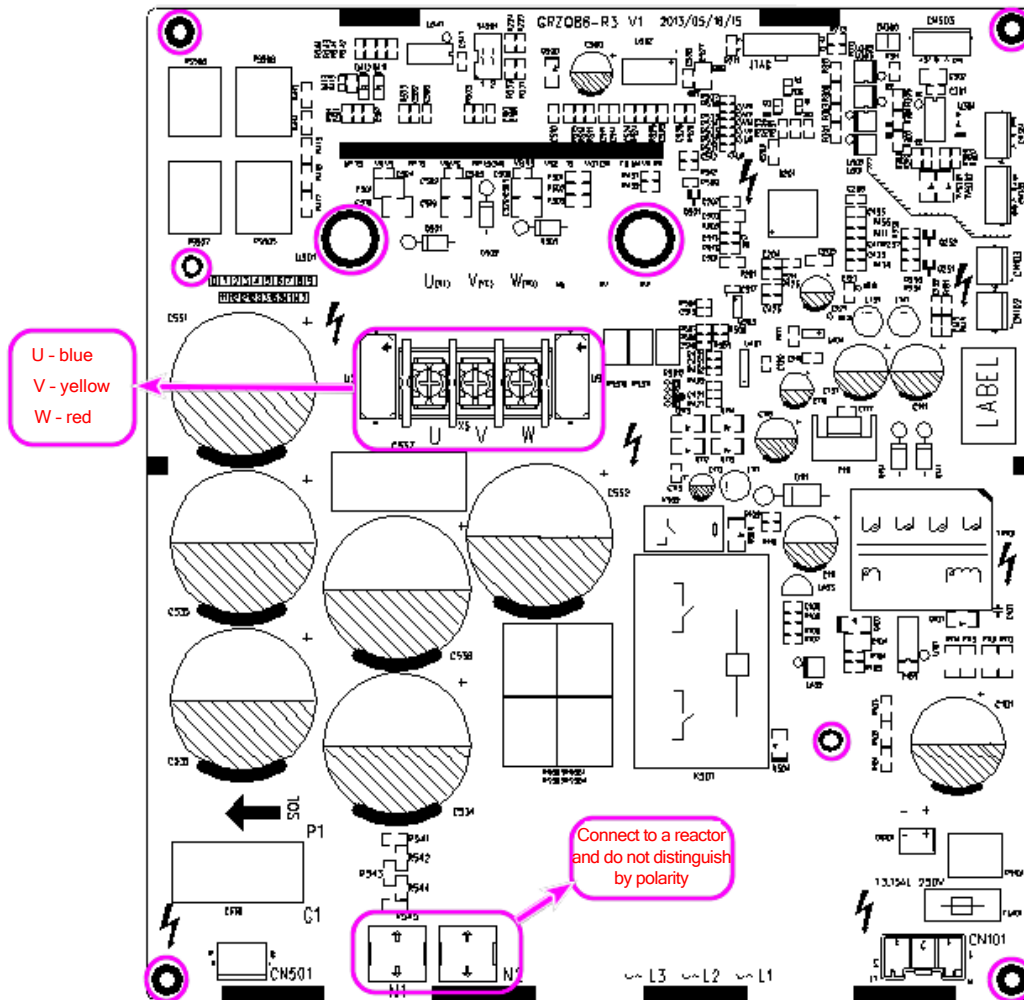

# 3.4 Assembling and Disassembling Key Parts of ODUs

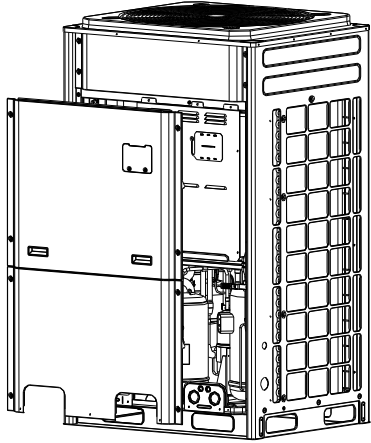
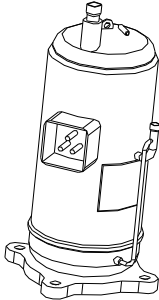
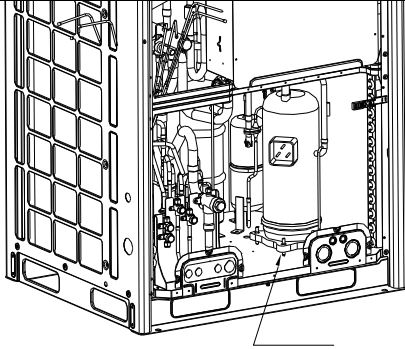
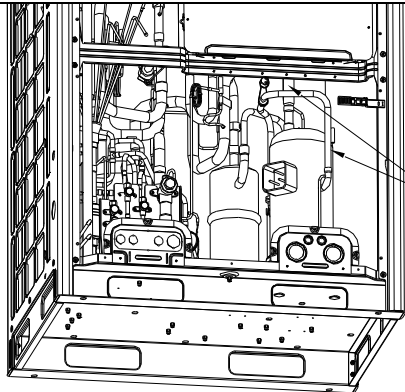
<b>Compressor</b>		
Precondition: No refrigerant exists in the pipeline system and the power supply has been disconnected.		
Step	Diagram	Operation Procedure
<p>1. Remove the front panels.</p>		<ul style="list-style-type: none"> <li>●Use a screwdriver to unscrew the upper and lower front panels.</li> <li>●Lift the front panels in order to take it out.</li> </ul> <p>Note: Both the upper panel and lower panel are fixed with two fasteners respectively to connect to the side panels.</p>
<p>2. Disconnect the power line of the compressor, and remove the electric heating belt, top temperature sensor, and discharge air temperature sensor.</p>		<ul style="list-style-type: none"> <li>●Remove the sound-proof sponge from the compressor.</li> <li>●Use a screwdriver to unscrew the power line.</li> <li>●Remove the power line.</li> <li>●Remove the electric heating belt, top temperature sensor, and discharge air temperature sensor.</li> </ul> <p>Note: Before removing the power line, mark the colours of the line and corresponding wiring terminals.</p>
<p>3. Loosen the nuts of the compressor.</p>		<ul style="list-style-type: none"> <li>●Use a wrench to unscrew the four nuts.</li> </ul>
<p>4. Remove the suction and discharge pipes.</p>		<ul style="list-style-type: none"> <li>●Heat the suction and discharge pipes by acetylene welding and then remove the pipes.</li> <li>●During welding, charge nitrogen into the pipes. The pressure should be controlled within <math>0.5 \pm 0.1 \text{ kgf/cm}^2</math> (relative pressure).</li> <li>●Avoid nearby materials from being burnt during welding.</li> </ul>

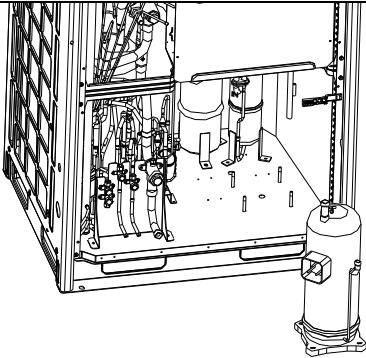
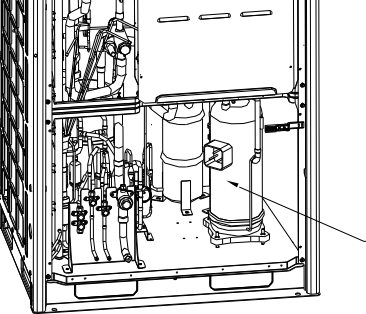
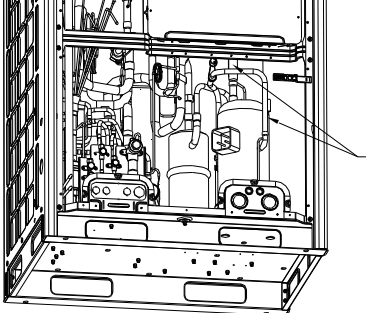
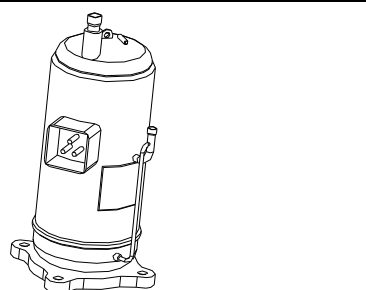
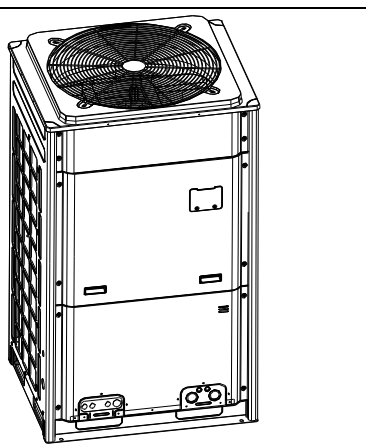
<p>5. Remove the compressor.</p>		<ul style="list-style-type: none"> <li>●Remove the compressor from the chassis.</li> </ul>
<p>6. Install a new compressor on the chassis.</p>		<ul style="list-style-type: none"> <li>●Put the compressor in a proper position.</li> <li>●Use a wrench to screw the nuts on the compressor.</li> <li>●The compressor should not be installed upside down.</li> </ul>
<p>7. Connect the suction and discharge pipes of the compressor to the pipeline system.</p>		<ul style="list-style-type: none"> <li>●Heat the suction and discharge pipes by acetylene welding and then install the pipes.</li> <li>●During welding, charge nitrogen into the pipes. The pressure should be controlled within <math>0.5 \pm 0.1 \text{ kgf/cm}^2</math> (relative pressure).</li> <li>●Avoid nearby materials from being burnt during welding.</li> </ul>
<p>8. Connect the power line to the compressor, and install the electric heating belt, top temperature sensor, and discharge air temperature sensor.</p>		<ul style="list-style-type: none"> <li>●Put the power line in a proper position.</li> <li>●Use a screwdriver to screw the power line.</li> <li>●Install the electric heating belt, top temperature sensor, and discharge air temperature sensor.</li> <li>●Put the sound-proof sponge back to position.</li> </ul>
<p>9. Check and then install the front panels.</p>		<ul style="list-style-type: none"> <li>●Check various parts and connecting lines.</li> <li>●If no problem is found, hook the front panels and tighten the screws.</li> </ul>
<p><b>Four-way valve</b></p>		
<p>Precondition: No refrigerant exists in the pipeline system and the power supply has been disconnected.</p>		
<p>Step</p>	<p>Diagram</p>	<p>Operation Procedure</p>

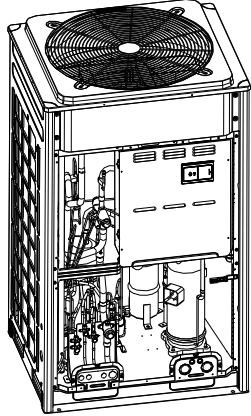
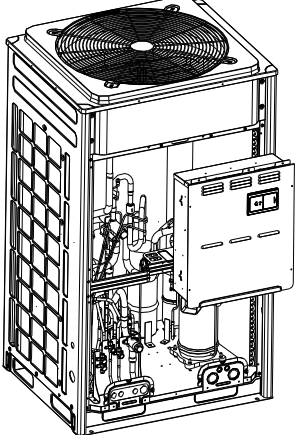
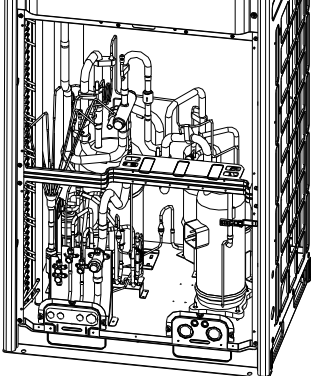
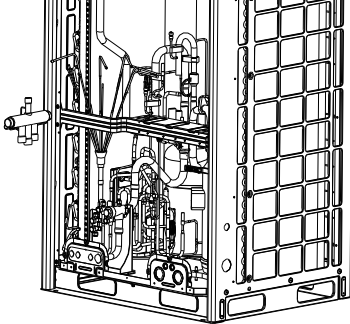
<p>1. Loosen the hooks at the bottom of the electric box and the screws.</p>		<ul style="list-style-type: none"> <li>● Remove the upper and lower front panels.</li> <li>● Loosen the hooks at the bottom of the electric box.</li> <li>● Use a screwdriver to unscrew the electric box.</li> </ul>
<p>2. Remove the electric box.</p>		<ul style="list-style-type: none"> <li>● Disconnect internal and external connecting lines of the electric box.</li> <li>● Protect the internal parts during the disassembly.</li> </ul>
<p>3. Disassemble the four-way valve.</p>		<p>Use a screwdriver to unscrew accessories of the four-way valve. Remove the accessories.</p> <ul style="list-style-type: none"> <li>● Heat the connecting pipes of the four-way valve by acetylene welding and then remove the pipes.</li> <li>● Record the direction of the valve and position of the pipe joints.</li> </ul> <p>Note: Avoid nearby parts from being burnt during welding.</p>
<p>4. Remove the four-way valve.</p>		<ul style="list-style-type: none"> <li>● Remove the four-way valve from the pipeline.</li> </ul>

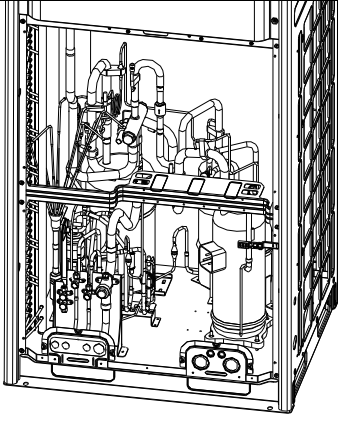
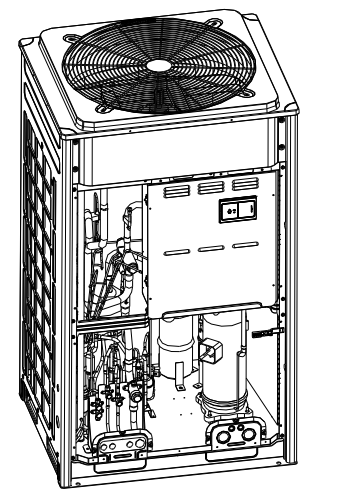
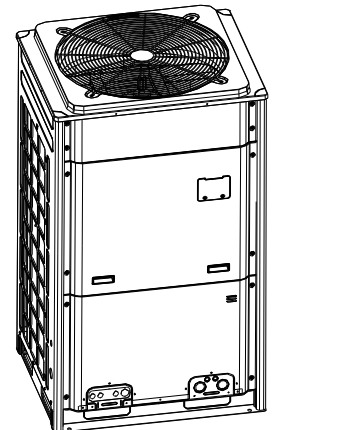
<p>5. Install a new four-way valve.</p>		<ul style="list-style-type: none"> <li>●Put the valve in a proper position.</li> <li>●Weld the valve with the pipeline.</li> <li>●Before welding, cover the valve with wet cloth to avoid internal slide from being burnt and prevent water from flowing in the pipeline.</li> <li>●During welding, charge nitrogen into the pipes. The pressure should be controlled within <math>0.5 \pm 0.1</math> kgf/cm<sup>2</sup> (relative pressure).</li> </ul>
<p>6. Fix and wire the electric box.</p>		<ul style="list-style-type: none"> <li>●Put the electric box back to original position and screw it.</li> <li>●Connect all lines.</li> </ul>
<p>7. Check and install the front panels.</p>		<ul style="list-style-type: none"> <li>●Check various parts and connecting lines.</li> <li>●If no problem is found, hook the front panels and tighten the screws.</li> </ul>

**Electric expansion valve**

Precondition: No refrigerant exists in the pipeline system and the power supply has been disconnected.

Step	Diagram	Operation Procedure
------	---------	---------------------

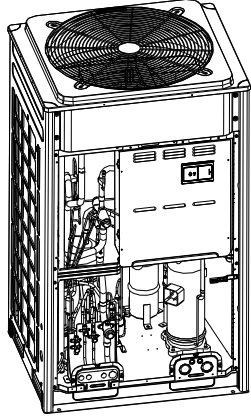
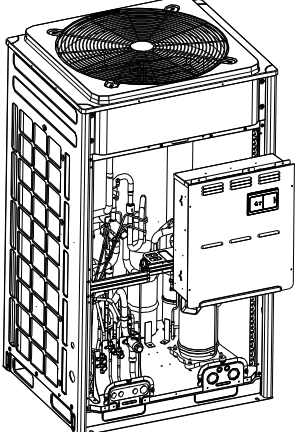
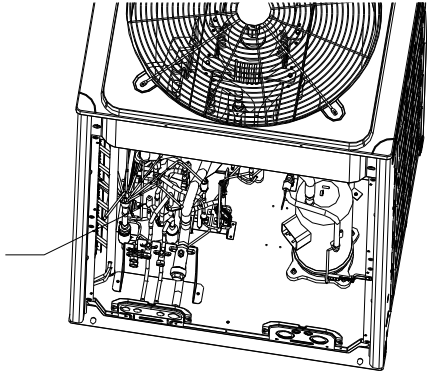
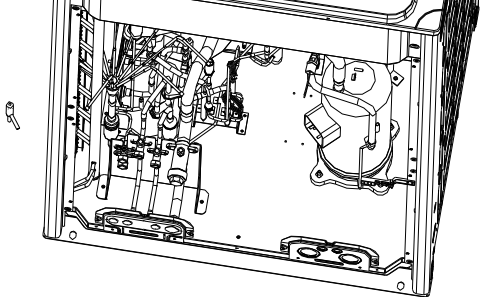
<p>1. Loosen the hooks at the bottom of the electric box and the screws.</p>		<ul style="list-style-type: none"> <li>●Remove the upper and lower front panels.</li> <li>●Loosen the hooks at the bottom of the electric box.</li> <li>●Use a screwdriver to unscrew the electric box.</li> </ul>
<p>2. Remove the electric box.</p>		<ul style="list-style-type: none"> <li>●Disconnect internal and external connecting lines of the electric box.</li> <li>●Protect the internal parts during the disassembly.</li> </ul>
<p>3. Disassemble the electric expansion valve.</p>		<ul style="list-style-type: none"> <li>●Remove the coil from the electric expansion valve.</li> <li>●Heat the connecting pipes of the electric expansion valve by welding and remove the pipes.</li> </ul> <p>Note: Avoid nearby parts from being burnt during welding.</p>
<p>4. Remove the electric expansion valve.</p>		<ul style="list-style-type: none"> <li>●Remove the electric expansion valve.</li> </ul>

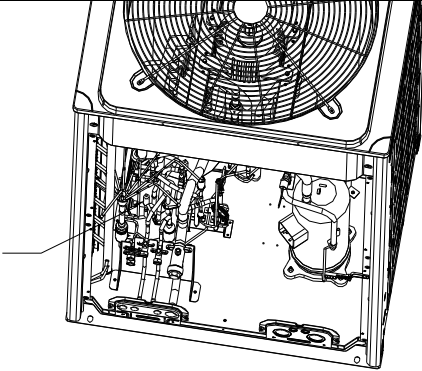
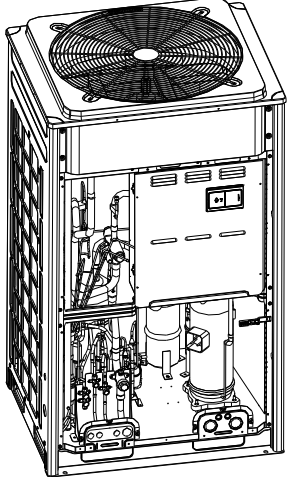
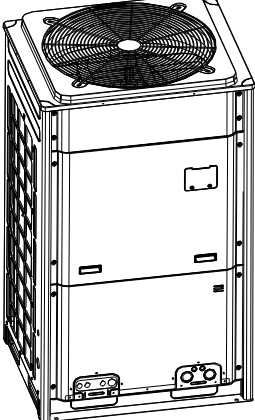

<p>5. Install a new electric expansion valve.</p>		<ul style="list-style-type: none"> <li>●Weld the connecting pipes with the electric expansion valve.</li> <li>●Before welding, cover the valve with wet cloth.</li> <li>●During welding, charge nitrogen into the pipes. The pressure should be controlled within <math>0.5\pm 0.1</math> kgf/cm<sup>2</sup> (relative pressure).</li> <li>Note: Avoid nearby parts from being burnt during welding.</li> <li>●Install the coil on the electric expansion valve.</li> </ul>
<p>6. Fix and wire the electric box.</p>		<ul style="list-style-type: none"> <li>●Put the electric box back to original position and screw it.</li> <li>●Connect all lines.</li> </ul>
<p>7. Check and install the front panels.</p>		<ul style="list-style-type: none"> <li>●Check various parts and connecting lines.</li> <li>●If no problem is found, hook the front panels and tighten the screws.</li> </ul>

**Oil separator**

Precondition: No refrigerant exists in the pipeline system and the power supply has been disconnected.

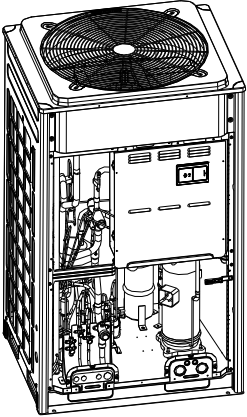
Step	Diagram	Operation Procedure
<p>1. Loosen the hooks at the bottom of the electric box and the screws.</p>		<ul style="list-style-type: none"> <li>●Remove the upper and lower front panels.</li> <li>●Loosen the hooks at the bottom of the electric box.</li> <li>●Use a screwdriver to unscrew the electric box.</li> </ul>

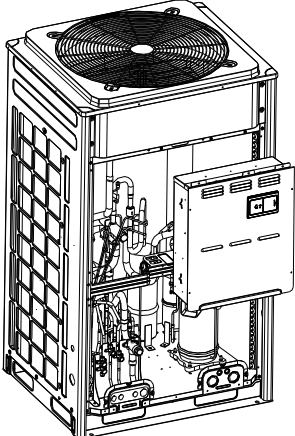
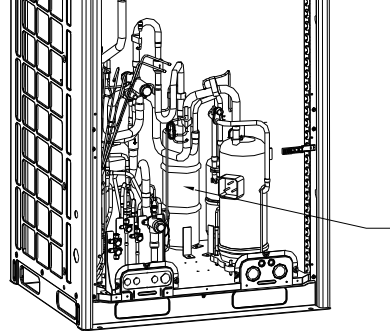
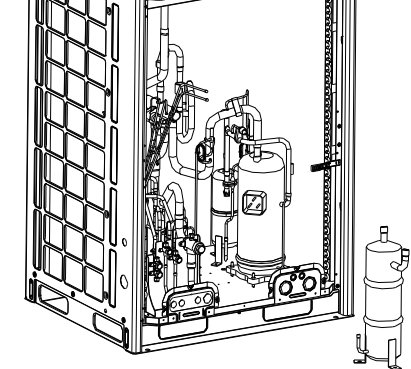
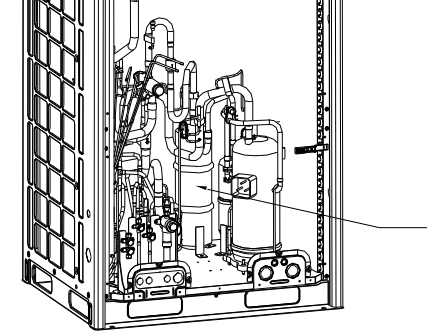
<p>2. Remove the electric box.</p>		<ul style="list-style-type: none"> <li>●Disconnect internal and external connecting lines of the electric box.</li> <li>●Protect the internal parts during the disassembly.</li> </ul>
<p>3. Disassemble the oil separator.</p>		<ul style="list-style-type: none"> <li>●Use a screwdriver to unscrew the oil separator.</li> <li>●Loosen the electric heating belt.</li> <li>●Heat the four pipe joints of the oil separator by welding and remove the connecting pipes.</li> </ul> <p>Note: Avoid nearby parts from being burnt during welding.</p>
<p>4. Remove the oil separator.</p>		<ul style="list-style-type: none"> <li>●Remove the oil separator from the chassis.</li> </ul>
<p>5. Install a new oil separator.</p>		<ul style="list-style-type: none"> <li>●Weld the four pipe joints with the oil separator.</li> </ul> <p>During welding, charge nitrogen into the pipes. The pressure should be controlled within <math>0.5 \pm 0.1</math> kgf/cm<sup>2</sup> (relative pressure).</p> <p>Note: Avoid nearby parts from being burnt during welding.</p> <ul style="list-style-type: none"> <li>●Screw the oil separator.</li> <li>●Tighten the electric heating belt.</li> </ul>

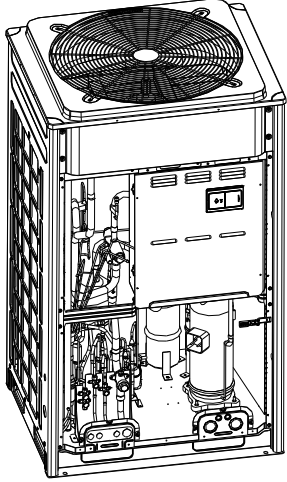
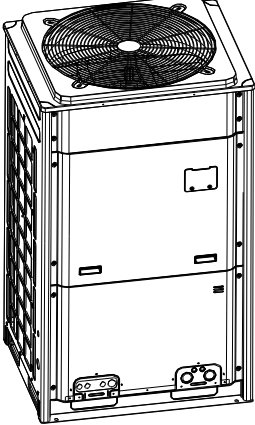
<p>6. Fix and wire the electric box.</p>		<ul style="list-style-type: none"> <li>●Put the electric box back to original position and screw it.</li> <li>●Connect all lines.</li> </ul>
<p>7. Check and install the front panels.</p>		<ul style="list-style-type: none"> <li>●Check various parts and connecting lines.</li> <li>●If no problem is found, hook the front panels and tighten the screws.</li> </ul>

**Gas/liquid separator**

Precondition: No refrigerant exists in the pipeline system and the power supply has been disconnected.

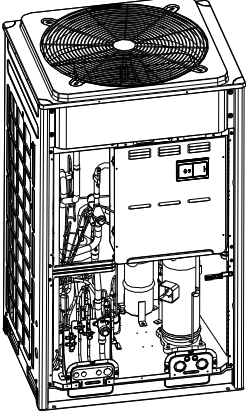
Step	Diagram	Operation Procedure
<p>1. Loosen the hooks at the bottom of the electric box and the screws.</p>		<ul style="list-style-type: none"> <li>●Remove the upper and lower front panels.</li> <li>●Loosen the hooks at the bottom of the electric box.</li> <li>●Use a screwdriver to unscrew the electric box.</li> </ul>

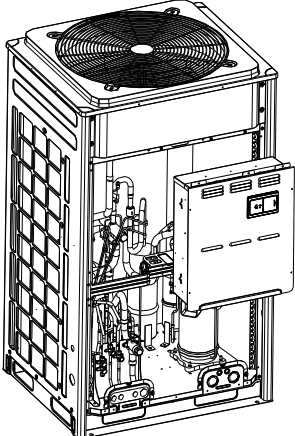
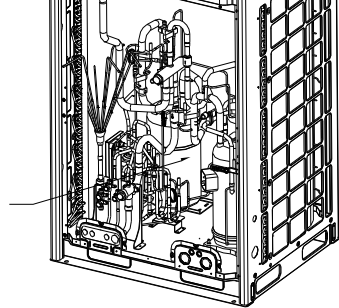
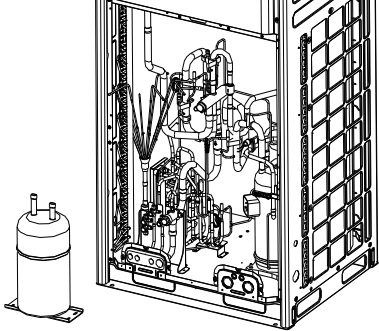
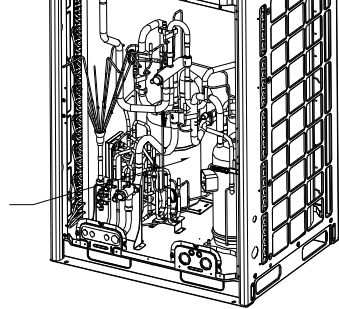
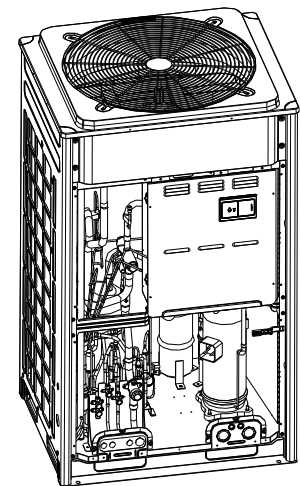
<p>2. Remove the electric box.</p>		<ul style="list-style-type: none"> <li>●Disconnect internal and external connecting lines of the electric box.</li> <li>●Protect the internal parts during the disassembly.</li> </ul>
<p>3. Disassemble the gas/liquid separator.</p>		<ul style="list-style-type: none"> <li>●Heat the connecting pipes of the gas/liquid separator by acetylene welding and then remove the pipes. Note: Avoid nearby parts from being burnt during welding.</li> </ul>
<p>4. Remove the gas/liquid separator.</p>		<ul style="list-style-type: none"> <li>●Unscrew and remove the gas/liquid separator.</li> </ul>
<p>5. Install a new gas/liquid separator.</p>		<ul style="list-style-type: none"> <li>●Put the gas/liquid separator based on the position of the suction and discharge pipes and weld the pipes with the gas/liquid separator.</li> <li>●During welding, charge nitrogen into the pipes. The pressure should be controlled within <math>0.5 \pm 0.1</math> kgf/cm<sup>2</sup> (relative pressure). Note: Avoid nearby parts from being burnt during welding.</li> <li>●Screw the gas/liquid separator.</li> </ul>
<p>6. Fix and wire the electric box.</p>		<ul style="list-style-type: none"> <li>●Put the electric box back to original position and screw it.</li> <li>●Connect all lines.</li> </ul>

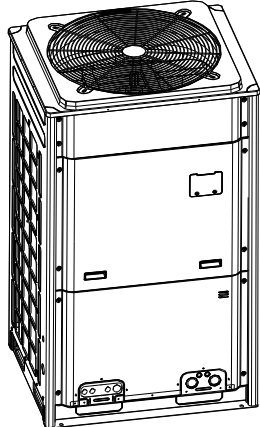
<p>7. Check and install the front panels.</p>		<ul style="list-style-type: none"> <li>•Check various parts and connecting lines.</li> <li>•If no problem is found, hook the front panels and tighten the screws.</li> </ul>
---	---	--

**Heat exchanging board**

Precondition: No refrigerant exists in the pipeline system and the power supply has been disconnected.

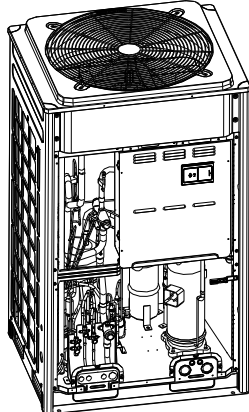
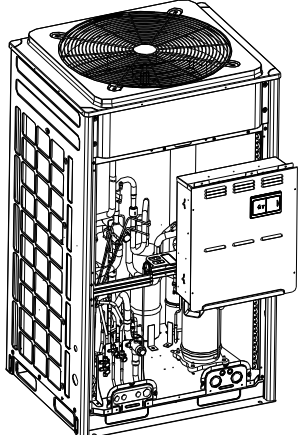
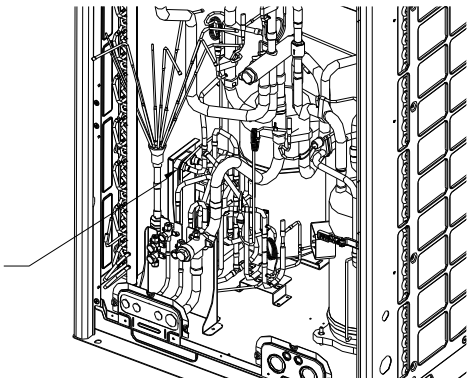
Step	Diagram	Operation Procedure
<p>1. Loosen the hooks at the bottom of the electric box and the screws.</p>		<ul style="list-style-type: none"> <li>•Remove the upper and lower front panels.</li> <li>•Loosen the hooks at the bottom of the electric box.</li> <li>•Use a screwdriver to unscrew the electric box.</li> </ul>
<p>2. Remove the electric box.</p>		<ul style="list-style-type: none"> <li>•Disconnect internal and external connecting lines of the electric box.</li> <li>•Protect the internal parts during the disassembly.</li> </ul>
<p>3. Disassemble the heat exchanging board.</p>		<ul style="list-style-type: none"> <li>•Heat the connecting pipes of the heat exchanging board by acetylene welding and then remove the pipes.</li> </ul> <p>Note: Avoid nearby parts from being burnt during welding. The joints of the board must be welded with copper plated steel. Ensure welding quality.</p>

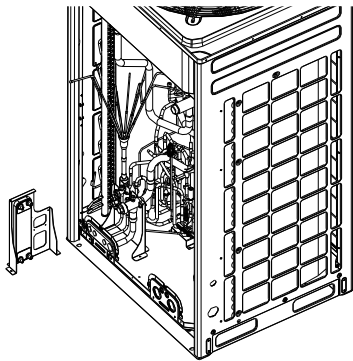
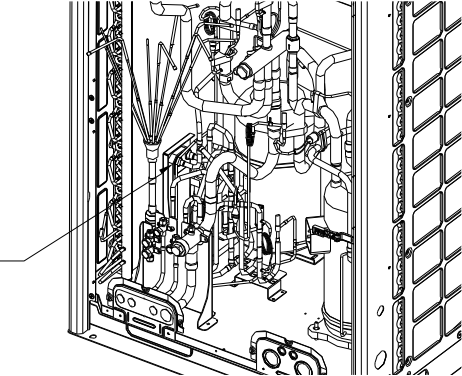
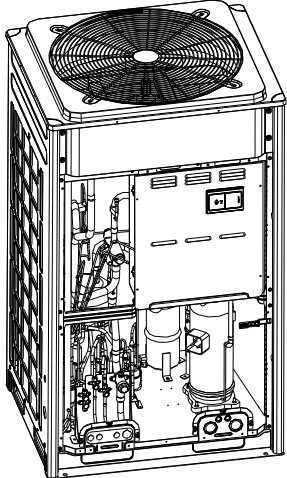
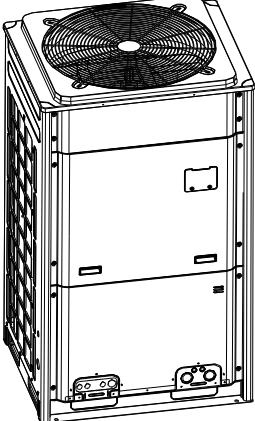
<p>4. Remove the heat exchanging board.</p>		<ul style="list-style-type: none"> <li>●Unscrew the support of the heat exchanging board, and remove the support and board.</li> </ul>
<p>5. Install a new heat exchanging board.</p>		<ul style="list-style-type: none"> <li>●Screw the support of the heat exchanging board and fix the board onto the chassis.</li> <li>●Put the heat exchanging board based on the position of the suction and discharge pipes and weld the pipes with the heat exchanging board.</li> <li>●During welding, charge nitrogen into the pipes. The pressure should be controlled within <math>0.5 \pm 0.1</math> kgf/cm<sup>2</sup> (relative pressure).</li> </ul> <p>Note: Avoid nearby parts from being burnt during welding.</p>
<p>6. Fix and wire the electric box.</p>		<ul style="list-style-type: none"> <li>●Put the electric box back to original position and screw it.</li> <li>●Connect all lines.</li> </ul>
<p>7. Check and install the front panels.</p>		<ul style="list-style-type: none"> <li>●Check various parts and connecting lines.</li> <li>●If no problem is found, hook the front panels and tighten the screws.</li> </ul>

## 3.5 Common Parameter Lists

### 3.5.1 R410a refrigerant pressure / saturation temperature list

Temperature (°C)	Corresponding saturation pressure (BAR)	Temperature (°C)	Corresponding saturation pressure (BAR)	Temperature (°C)	Corresponding saturation pressure (BAR)
-43	1.54	-9	5.96	25	16.4
-42	1.61	-8	6.16	26	16.9
-41	1.68	-7	6.37	27	17.3
-40	1.76	-6	6.58	28	17.8
-39	1.84	-5	6.80	29	15.9
-38	1.93	-4	7.03	30	18.7
-37	2.02	-3	7.26	31	19.2
-36	2.11	-2	7.50	32	19.7
-35	2.24	-1	7.74	33	20.2
-34	2.33	0	7.99	34	20.7
-33	2.43	1	5.94	35	21.2
-32	2.53	2	8.50	36	21.7
-31	2.64	3	8.77	37	22.3
-30	2.75	4	9.04	38	22.8
-29	2.86	5	9.32	39	23.4
-28	2.98	6	9.61	40	24.0
-27	3.10	7	9.90	41	24.6
-26	3.22	8	10.2	42	25.2
-25	3.35	9	10.5	43	25.8
-24	3.48	10	10.8	44	26.4
-23	3.61	11	11.1	45	27.0
-22	3.75	12	11.5	46	27.7
-21	3.89	13	11.8	47	28.3
-20	4.04	14	12.1	48	29.0
-19	4.19	15	12.5	49	29.6
-18	4.35	16	12.8	50	30.3
-17	4.51	17	13.2	52	31.7
-16	4.67	18	13.6	54	33.2
-15	4.84	19	14.0	56	34.7
-14	5.02	20	14.4	58	36.3
-13	5.19	21	14.7	60	37.9
-12	5.38	22	15.2	62	40.17
-11	5.57	23	15.6	65	42.78
-10	5.76	24	16.015	67	44.57

### 3.5.2 Resistance / temperature lists of temperature sensors

#### 3.5.2.1 Voltage list of 15 kΩ temperature sensors (including ODU and IDU temperature sensors)

Temperature (°C)	Resistance (kΩ)	Voltage (V)	Temperature (°C)	Resistance (kΩ)	Voltage (V)
-20	144	0.311	71	2.523	2.825
-19	138.1	0.323	72	2.439	2.838
-18	128.6	0.345	73	2.358	2.852
-17	121.6	0.362	74	2.28	2.865
-16	115	0.381	75	2.205	2.877
-15	108.7	0.4	76	2.133	2.889
-14	102.9	0.42	77	2.064	2.901
-13	97.4	0.44	78	1.997	2.912
-12	92.22	0.462	79	1.933	2.923
-11	87.35	0.484	80	1.871	2.934
-10	82.75	0.506	81	1.811	2.945
-9	78.43	0.53	82	1.754	2.955
-8	74.35	0.554	83	1.699	2.964
-7	70.5	0.579	84	1.645	2.974
-6	66.88	0.605	85	1.594	2.983
-5	63.46	0.631	86	1.544	2.992
-4	60.23	0.658	87	1.497	3.001

GMV5 DC INVERTER VRF UNITS SERVICE MANUAL

-3	57.18	0.686	88	1.451	3.009
-2	54.31	0.714	89	1.408	3.017
-1	51.59	0.743	90	1.363	3.025
0	49.02	0.773	91	1.322	3.033
1	46.8	0.801	92	1.282	3.04
2	44.31	0.835	93	1.244	3.047
3	42.14	0.866	94	1.207	3.054
4	40.09	0.899	95	1.171	3.061
5	38.15	0.931	96	1.136	3.068
6	36.32	0.965	97	1.103	3.074
7	34.58	0.998	98	1.071	3.08
8	32.94	1.033	99	1.039	3.086
9	31.38	1.067	100	1.009	3.092
10	29.9	1.102	101	0.98	3.098
11	28.51	1.138	102	0.952	3.103
12	27.18	1.174	103	0.925	3.108
13	25.92	1.21	104	0.898	3.114
14	24.73	1.246	105	0.873	3.119
15	23.6	1.282	106	0.848	3.123
16	22.53	1.319	107	0.825	3.128
17	21.51	1.356	108	0.802	3.133
18	20.54	1.393	109	0.779	3.137
19	19.63	1.429	110	0.758	3.141
20	18.75	1.467	111	0.737	3.145
21	17.93	1.503	112	0.717	3.15
22	17.14	1.54	113	0.697	3.153
23	16.39	1.577	114	0.678	3.157
24	15.68	1.613	115	0.66	3.161
25	15	1.65	116	0.642	3.165
26	14.36	1.686	117	0.625	3.168
27	13.74	1.722	118	0.608	3.171
28	13.16	1.758	119	0.592	3.175
29	12.6	1.793	120	0.577	3.178
30	12.07	1.829	121	0.561	3.181
31	11.57	1.863	122	0.547	3.184
32	11.09	1.897	123	0.532	3.187
33	10.63	1.931	124	0.519	3.19
34	10.2	1.964	125	0.505	3.192
35	9.779	1.998	126	0.492	3.195
36	9.382	2.03	127	0.48	3.198
37	9.003	2.062	128	0.467	3.2
38	8.642	2.094	129	0.456	3.203
39	5.997	2.125	130	0.444	3.205
41	7.653	2.185	131	0.433	3.207
42	7.352	2.215	132	0.422	3.21
43	7.065	2.243	133	0.412	3.212
44	6.791	2.272	134	0.401	3.214
45	6.529	2.299	135	0.391	3.216
46	6.278	2.326	136	0.382	3.218
47	6.038	2.353	137	0.372	3.22
48	5.809	2.379	138	0.363	3.222
49	5.589	2.404	139	0.355	3.224
50	5.379	2.429	140	0.346	3.226
51	5.179	2.453	141	0.338	3.227
52	4.986	2.477	142	0.33	3.229
53	4.802	2.5	143	0.322	3.231
54	4.625	2.522	144	0.314	3.232
55	4.456	2.544	145	0.307	3.234
56	4.294	2.566	146	0.299	3.235
57	4.139	2.586	147	0.292	3.237
58	3.99	2.607	148	0.286	3.238
59	3.848	2.626	149	0.279	3.24
60	3.711	2.646	150	0.273	3.241
61	3.579	2.664	151	0.266	3.242
62	3.454	2.682	152	0.261	3.244
63	3.333	2.7	153	0.254	3.245
64	3.217	2.717	154	0.248	3.246



GMV5 DC INVERTER VRF UNITS SERVICE MANUAL

65	3.105	2.734	155	0.243	3.247
66	2.998	2.75	156	0.237	3.249
67	2.898	2.766	157	0.232	3.25
68	2.797	2.781	158	0.227	3.251
69	2.702	2.796	159	0.222	3.252
70	2.611	2.811	160	0.217	3.253

3.5.2.2 Voltage list of 20 kΩ pipeline temperature sensors (including temperature sensors for defroster, sub-cooler, gas/liquid separator, and IDU suction and discharge pipes)

Temperature (°C)	Resistance (kΩ)	Voltage (V)	Temperature (°C)	Resistance (kΩ)	Voltage (V)
-30	361.8	0.173	66	3.998	2.75
-29	339.8	0.183	67	3.861	2.766
-28	319.2	0.195	68	3.729	2.781
-27	300	0.206	69	3.603	2.796
-26	282.2	0.218	70	3.481	2.811
-25	265.5	0.231	71	3.364	2.825
-24	249.9	0.245	72	3.252	2.838
-23	235.3	0.259	73	3.144	2.852
-22	221.6	0.273	74	3.04	2.865
-21	208.9	0.288	75	2.94	2.877
-20	196.9	0.304	76	2.844	2.889
-19	181.4	0.328	77	2.752	2.901
-18	171.4	0.345	78	2.663	2.912
-17	162.1	0.362	79	2.577	2.923
-16	153.3	0.381	80	2.495	2.934
-15	145	0.4	81	2.415	2.944
-14	137.2	0.42	82	2.339	2.954
-13	129.9	0.44	83	2.265	2.964
-12	123	0.462	84	2.194	2.974
-11	116.5	0.484	85	2.125	2.983
-10	110.3	0.507	86	2.059	2.992
-9	104.6	0.53	87	1.996	3.001
-8	99.13	0.554	88	1.934	3.009
-7	94	0.579	89	1.875	3.017
-6	89.17	0.605	90	1.818	3.025
-5	84.61	0.631	91	1.763	3.033
-4	80.31	0.658	92	1.71	3.04
-3	76.24	0.686	93	1.658	3.047
-2	72.41	0.714	94	1.609	3.054
-1	68.79	0.743	95	1.561	3.061
0	65.37	0.773	96	1.515	3.068
1	62.13	0.804	97	1.47	3.074
2	59.08	0.835	98	1.427	3.08
3	56.19	0.866	99	1.386	3.086
4	53.46	0.898	100	1.346	3.092
5	50.87	0.931	101	1.307	3.098
6	48.42	0.965	102	1.269	3.103
7	46.11	0.998	103	1.233	3.108
8	43.92	1.033	104	1.198	3.114
9	41.84	1.067	105	1.164	3.119
10	39.87	1.102	106	1.131	3.123
11	38.01	1.138	107	1.099	3.128
12	36.24	1.174	108	1.069	3.133
13	34.57	1.209	109	1.039	3.137
14	32.98	1.246	110	1.01	3.141
15	31.47	1.282	111	0.9825	3.145
16	30.04	1.319	112	0.9556	3.15
17	28.68	1.356	113	0.9295	3.153
18	27.39	1.393	114	0.9043	3.157
19	26.17	1.429	115	0.8799	3.161
20	25.01	1.466	116	0.8562	3.165
21	23.9	1.503	117	0.8333	3.168
22	22.85	1.54	118	0.8111	3.171
23	21.85	1.577	119	0.7895	3.175

GMV5 DC INVERTER VRF UNITS SERVICE MANUAL

24	20.9	1.614	120	0.7687	3.178
25	20	1.65	121	0.7485	3.181
26	19.14	1.686	122	0.7289	3.184
27	18.32	1.722	123	0.7099	3.187
28	17.55	1.758	124	0.6915	3.19
29	16.8	1.793	125	0.6736	3.192
30	16.1	1.828	126	0.6563	3.195
31	15.43	1.863	127	0.6395	3.198
32	14.79	1.897	128	0.6232	3.2
33	14.18	1.931	129	0.6074	3.203
34	13.59	1.965	130	0.5921	3.205
35	13.04	1.998	131	0.5772	3.207
36	12.51	2.03	132	0.5627	3.21
37	12	2.063	133	0.5487	3.212
38	11.52	2.094	134	0.5351	3.214
39	11.06	2.125	135	0.5219	3.216
40	10.62	2.155	136	0.509	3.218
41	10.2	2.185	137	0.4966	3.22
42	9.803	2.215	138	0.4845	3.222
43	9.42	2.243	139	0.4727	3.224
44	9.054	2.272	140	0.4613	3.226
45	8.705	2.299	141	0.4502	3.227
46	8.37	2.326	142	0.4394	3.229
47	8.051	2.353	143	0.4289	3.231
48	7.745	2.379	144	0.4187	3.232
49	7.453	2.404	145	0.4088	3.234
50	7.173	2.429	146	0.3992	3.235
51	6.905	2.453	147	0.3899	3.237
52	6.648	2.477	148	0.3808	3.238
53	6.403	2.5	149	0.3719	3.24
54	6.167	2.522	150	0.3633	3.241
55	5.942	2.544	151	0.3549	3.242
56	5.726	2.565	152	0.3468	3.244
57	5.519	2.586	153	0.3389	3.245
58	5.32	2.607	154	0.3312	3.246
59	5.13	2.626	155	0.3237	3.247
60	4.948	2.646	156	0.3164	3.249
61	4.773	2.664	157	0.3093	3.25
62	4.605	2.682	158	0.3024	3.251
63	4.443	2.7	159	0.2956	3.252
64	4.289	2.717	160	0.2891	3.253
65	4.14	2.734			

3.5.2.3 Voltage list of 50 kΩ discharge temperature sensors (including top temperature sensor, and discharge air temperature sensor)

Temperature (°C)	Resistance (kΩ)	Voltage (V)	Temperature (°C)	Resistance (kΩ)	Voltage (V)
-30	911.56	0.036	61	11.736	1.518
-29	853.66	0.038	62	11.322	1.548
-28	799.98	0.041	63	10.925	1.577
-27	750.18	0.043	64	10.544	1.606
-26	703.92	0.046	65	10.178	1.635
-25	660.93	0.049	66	9.8269	1.664
-24	620.94	0.052	67	9.4896	1.693
-23	583.72	0.056	68	9.1655	1.722
-22	549.04	0.059	69	8.9542	1.741
-21	516.71	0.063	70	8.5551	1.778
-20	486.55	0.066	71	5.9676	1.806
-19	458.4	0.07	72	7.9913	1.834
-18	432.1	0.075	73	7.7257	1.862
-17	407.51	0.079	74	7.4702	1.889
-16	384.51	0.084	75	7.2245	1.916
-15	362.99	0.088	76	6.9882	1.943
-14	342.83	0.094	77	6.7608	1.969
-13	323.94	0.099	78	6.542	1.995

GMV5 DC INVERTER VRF UNITS SERVICE MANUAL

-12	306.23	0.104	79	6.3315	2.021
-11	289.61	0.11	80	6.1288	2.046
-10	274.02	0.116	81	5.9336	2.071
-9	259.37	0.123	82	5.7457	2.096
-8	245.61	0.129	83	5.5647	2.12
-7	232.67	0.136	84	5.3903	2.144
-6	220.5	0.143	85	5.2223	2.168
-5	209.05	0.151	86	5.0605	2.191
-4	195.97	0.158	87	4.9044	2.214
-3	188.12	0.167	88	4.7541	2.237
-2	178.65	0.175	89	4.6091	2.259
-1	169.68	0.184	90	4.4693	2.281
0	161.02	0.193	91	4.3345	2.302
1	153	0.202	92	4.2044	2.323
2	145.42	0.212	93	4.0789	2.344
3	135.96	0.223	94	3.9579	2.364
4	131.5	0.233	95	3.841	2.384
5	126.17	0.242	96	3.7283	2.404
6	119.08	0.256	97	3.6194	2.423
7	113.37	0.267	98	3.5143	2.442
8	107.96	0.28	99	3.4128	2.46
9	102.85	0.292	100	3.3147	2.478
10	98.006	0.306	101	3.22	2.496
11	93.42	0.319	102	3.1285	2.514
12	89.075	0.333	103	3.0401	2.531
13	84.956	0.348	104	2.9547	2.547
14	81.052	0.362	105	2.8721	2.564
15	77.349	0.378	106	2.7922	2.58
16	73.896	0.393	107	2.715	2.595
17	70.503	0.41	108	2.6404	2.611
18	67.338	0.427	109	2.5682	2.626
19	64.333	0.444	110	2.4983	2.64
20	61.478	0.462	111	2.4308	2.655
21	58.766	0.48	112	2.3654	2.669
22	56.189	0.499	113	2.3021	2.682
23	53.738	0.518	114	2.2409	2.696
24	51.408	0.537	115	2.1816	2.709
25	49.191	0.558	116	2.1242	2.722
26	47.082	0.578	117	2.0686	2.734
27	45.074	0.599	118	2.0148	2.747
28	43.163	0.621	119	1.9626	2.759
29	41.313	0.643	120	1.9123	2.77
30	39.61	0.665	121	1.8652	2.781
31	37.958	0.688	122	1.8158	2.793
32	36.384	0.711	123	1.7698	2.804
33	34.883	0.735	124	1.7253	2.814
34	33.453	0.759	125	1.6821	2.825
35	32.088	0.784	126	1.6402	2.835
36	30.787	0.809	127	1.5996	2.845
37	29.544	0.835	128	1.5602	2.855
38	28.359	0.86	129	1.522	2.864
39	27.227	0.886	130	1.485	2.873
40	26.147	0.913	131	1.449	2.882
41	25.114	0.94	132	1.4141	2.891
42	24.128	0.967	133	1.3803	2.9
43	23.186	0.994	134	1.3474	2.908
44	22.286	1.022	135	1.3155	2.916
45	21.425	1.05	136	1.2846	2.924
46	20.601	1.078	137	1.2545	2.932
47	19.814	1.107	138	1.2233	2.94
48	19.061	1.136	139	1.1969	2.947
49	18.34	1.164	140	1.1694	2.955
50	17.651	1.193	141	1.1476	2.96
51	16.99	1.223	142	1.1166	2.969
52	16.358	1.252	143	1.0913	2.975
53	15.753	1.281	144	1.0667	2.982
54	15.173	1.311	145	1.0429	2.988

GMV5 DC INVERTER VRF UNITS SERVICE MANUAL

55	14.618	1.34	146	1.0197	2.995
56	14.085	1.37	147	0.9971	3.001
57	13.575	1.4	148	0.9752	3.007
58	13.086	1.429	149	0.9538	3.013
59	12.617	1.459	150	0.9331	3.018
60	12.368	1.475			

**3.5.3 Voltage / pressure lists of pressure sensors**

3.5.3.1 High-pressure sensor (R410a)

Temperature (°C)	Absolute pressure (kPa)	Voltage (V)	Temperature (°C)	Absolute pressure (kPa)	Voltage (V)
-40	176	0.102	16	1300	1.3
-39	184	0.111	17	1337	1.34
-38	193	0.12	18	1375	1.38
-37	202	0.13	19	1413	1.421
-36	211	0.139	20	1453	1.463
-35	220	0.149	21	1493	1.506
-34	230	0.16	22	1535	1.551
-33	240	0.17	23	1577	1.596
-32	250	0.181	24	1620	1.641
-31	261	0.193	25	1664	1.688
-30	273	0.206	26	1708	1.735
-29	283	0.216	27	1754	1.784
-28	295	0.229	28	1801	1.834
-27	307	0.242	29	1848	1.884
-26	319	0.255	30	1897	1.937
-25	332	0.268	31	1946	1.989
-24	345	0.282	32	1996	2.042
-23	359	0.297	33	2048	2.098
-22	373	0.312	34	2100	2.153
-21	388	0.328	35	2153	2.21
-20	403	0.344	36	2208	2.268
-19	418	0.36	37	2263	2.327
-18	434	0.377	38	2320	2.388
-17	450	0.394	39	2377	2.448
-16	467	0.412	40	2436	2.511
-15	484	0.43	41	2495	2.574
-14	502	0.45	42	2556	2.639
-13	520	0.469	43	2618	2.705
-12	538	0.488	44	2681	2.772
-11	558	0.509	45	2745	2.841
-10	577	0.53	46	2810	2.91
-9	597	0.551	47	2876	2.98
-8	618	0.573	48	2944	3.053
-7	639	0.596	49	3013	3.126
-6	661	0.619	50	3083	3.201
-5	684	0.644	51	3154	3.277
-4	707	0.668	52	3226	3.353
-3	730	0.693	53	3300	3.432
-2	754	0.718	54	3374	3.511
-1	779	0.745	55	3450	3.592
0	804	0.772	56	3528	3.675
1	830	0.799	57	3606	3.759
2	857	0.828	58	3686	3.844
3	884	0.857	59	3767	3.93
4	912	0.887	60	3849	4.018
5	940	0.917	61	3932	4.106
6	969	0.947	62	4017	4.197
7	999	0.979	63	4103	4.288
8	1030	1.012	64	4190	4.381
9	1061	1.046	65	4278	4.475
10	1093	1.08	66	4367	4.57
11	1125	1.114	67	4457	4.666
12	1159	1.15	68	4548	4.763

GMV5 DC INVERTER VRF UNITS SERVICE MANUAL

13	1193	1.186	69	4639	4.86
14	1228	1.224	70	4731	4.958
15	1263	1.261	71	4893	5.13

3.5.3.2 Low-pressure sensor (R410a)

Temperature (°C)	Absolute pressure (kPa)	Voltage (V)	Temperature (°C)	Absolute pressure (kPa)	Voltage (V)
-70	36	0.369	-14	502	1.301
-69	38	0.373	-13	520	1.337
-68	40	0.377	-12	538	1.373
-67	43	0.383	-11	558	1.413
-66	46	0.389	-10	577	1.451
-65	48	0.393	-9	597	1.491
-64	51	0.399	-8	618	1.533
-63	54	0.405	-7	639	1.575
-62	57	0.411	-6	661	1.619
-61	61	0.419	-5	684	1.665
-60	64	0.425	-4	707	1.711
-59	68	0.433	-3	730	1.757
-58	72	0.441	-2	754	1.805
-57	76	0.449	-1	799	1.895
-56	80	0.457	0	804	1.905
-55	84	0.465	1	830	1.957
-54	89	0.475	2	857	2.011
-53	94	0.485	3	884	2.065
-52	99	0.495	4	912	2.121
-51	104	0.505	5	940	2.177
-50	109	0.515	6	969	2.235
-49	115	0.527	7	999	2.295
-48	121	0.539	8	1030	2.357
-47	127	0.551	9	1061	2.419
-46	133	0.563	10	1096	2.489
-45	140	0.577	11	1125	2.547
-44	146	0.589	12	1159	2.615
-43	154	0.605	13	1193	2.683
-42	161	0.619	14	1228	2.753
-41	168	0.633	15	1263	2.823
-40	176	0.649	16	1300	2.897
-39	184	0.665	17	1337	2.971
-38	193	0.683	18	1375	3.047
-37	202	0.701	19	1413	3.123
-36	211	0.719	20	1453	3.203
-35	220	0.737	21	1493	3.283
-34	230	0.757	22	1535	3.367
-33	240	0.777	23	1577	3.451
-32	250	0.797	24	1620	3.537
-31	261	0.819	25	1664	3.625
-30	272	0.841	26	1708	3.713
-29	283	0.863	27	1754	3.805
-28	295	0.887	28	1801	3.899
-27	307	0.911	29	1848	3.993
-26	319	0.935	30	1897	4.091
-25	332	0.961	31	1946	4.189
-24	345	0.987	32	1996	4.289
-23	359	1.015	33	2048	4.393
-22	373	1.043	34	2100	4.497
-21	388	1.073	35	2153	4.603
-20	403	1.103	36	2208	4.713
-19	418	1.133	37	2263	4.823
-18	434	1.165	38	2320	4.937
-17	450	1.197	39	2377	5.051
-16	467	1.231	40	2439	5.175
-15	484	1.265			

# 3.6 Exploded Views and Spae Part List

## 3.6.1 Model: GMV-224WM/B-X, GMV-280WM/B-X

Exploded View:

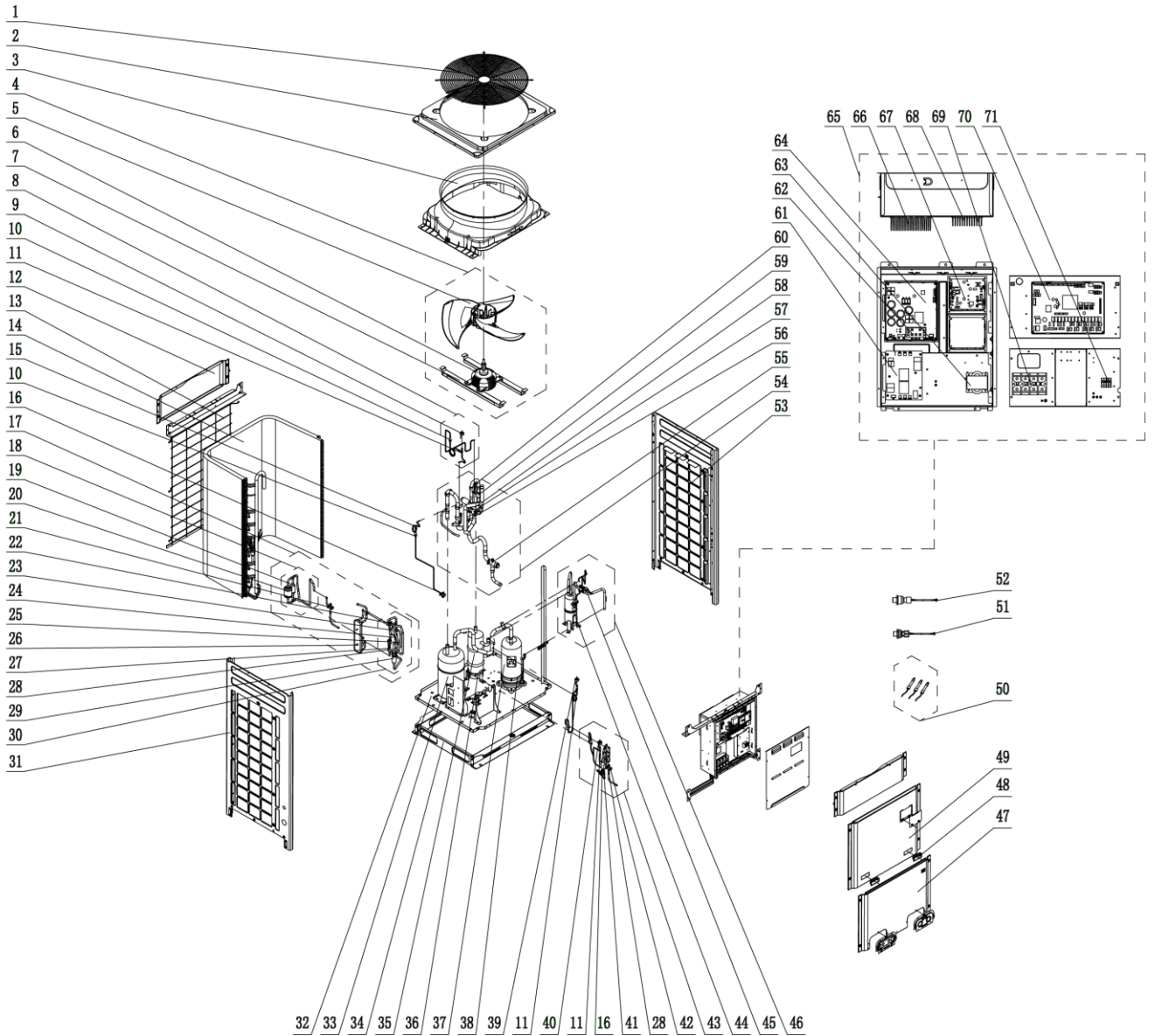

Parts List:

No.	Name of part	GMV-224WM/B-X		GMV-280WM/B-X	
		Product Code	CN851W1280	Product Code	CN851W1290
		Part code	Quantity	Part code	Quantity
1	Rear Grill	01574105	1	01574105	1
2	Top Cover	01264230	1	01264230	1
3	Diversion Circle	10474100	1	10474100	1
4	Fan motor Sub-Assy	15404605	1	15404605	1
5	Axial Flow Fan Sub-Assy	10338702	1	10338702	1
6	Fan Motor	15704124	1	15704124	1
7	Motor Support Sub-Assy	01804771P	1	01804771P	1
8	Gas By-pass Sub-Assy	04224100129	1	04224100129	1
9	Magnet Coil	4304000425	1	4304000425	1

GMV5 DC INVERTER VRF UNITS SERVICE MANUAL

10	Filter	07415200002	1	07415200002	1
11	Electromagnetic Valve	43000054	1	43000054	1
12	Top Cover	01264231P	2	01264231P	2
13	Rear Grill	01576013	1	01576013	1
14	Condenser Assy	0112431001	1	0112431001	1
15	Low Pressure Survey Valve Sub-Assy	07334100026	1	07334100026	1
16	Cut-off Valve 1/4	07130239	1	07130239	1
17	Throttle Assy	05374100006	1	05374100006	1
18	Dry Filter Sub-Assy	07314100001	1	07314100001	1
19	Gas Tube Filter	072190511	1	072190511	1
20	Dry Filter	07218769	1	07218769	1
21	Cut-off Valve 3/8	07334100011	1	07334100011	1
22	Electronic Expansion Valve Coil	4304413206	1	4304413206	1
23	Electronic Expansion Valve	07334390	1	07334390	1
24	Discharge Valve	07334100002	1	07334100002	1
25	Electronic Expansion Valve Coil	4304413204	1	4304413204	1
26	Plate-type Heat Exchanger	00904100005	1	00904100005	1
27	Electronic Expansion Valve	07334412	1	07334412	1
28	One way Valve	04324001	1	04324001	1
29	Bidirectional Filter	07210044	1	07210044	1
30	Electronic Expansion Valve Sub-Assy	07334100030	1	07334100030	1
31	Left Side Plate	01314712P	1	01314712P	1
32	Chassis Sub-assy	01194708	1	01194708	1
33	Gas-liquid Separator	07424188	1	07424188	1
34	Base Frame Assy	01284711	1	01284711	1
35	Oil Separator	0742418601	1	0742418601	1
36	Electrical Heater(Compressor)	7651873209	1	7651873209	1
37	Compressor and Fittings	00204100002	1	00204100002	1
38	Electric Heater(Compressor)	7651540713	1	7651540713	1
39	Magnet Coil	4304000423	1	4304000423	1
40	Magnet Coil	4304000415	1	4304000415	1
41	Gas Tube Filter	072190511	1	072190511	1
42	Cut-off Valve	07334100011	1	07334100011	1
43	Oil Equalizing Pipe Sub-Assy	04224100148	1	04224100148	1
44	Oil Separator	07424100023	1	07424100023	1
45	Pressure Switch	4602000911	1	4602000911	1
46	Discharge Tube Sub-assy	04534100050	1	04534100050	1
47	Front Panel	01544627P	1	01544627P	1
48	Handle	26904100016	2	26904100016	2
49	Front Panel	01544620P	1	01544620P	1
50	Temperature Sensor Sub-Assy	39008000006G	1	39008000006G	1
51	Pressure Sensor	32218000009	1	32218000009	1
52	Pressure Sensor	32218000008	1	32218000008	1
53	Right Side Plate	01314713P	1	01314713P	1
54	4-Way Valve Sub-Assy	04044100013	1	04044100013	1
55	Cut-off Valve 1-1/8	07334100014	1	07334100014	1
56	Filter	07218603	1	07218603	1

GMV5 DC INVERTER VRF UNITS SERVICE MANUAL

57	Magnet Coil	4300040032	1	4300040032	1
58	4-way Valve	43000339	1	43000339	1
59	One way Valve	07335210	1	07335210	1
60	Nozzle for Adding Freon	06120012	2	06120012	2
61	Filter Board	30228000015	1	30228000015	1
62	Rectifier	46010604	1	46010604	1
63	Reactor	43138000034	1	43138000034	1
64	Main Board	30228000010	1	30228000010	1
65	Electric Box Assy	01394100191	1	01394100191	1
66	Radiator	49018000002	1	49018000002	1
67	Main Board	30229010	1	30229010	1
68	Radiator	49018000001	1	49018000001	1
69	Terminal Board	42010247	1	42010247	1
70	Main Board	30223000005	1	30223000005	1
71	Terminal Board	42018000026	1	42018000026	1

Above data is subject to change without notice,pls reference the SP in global service website.



3.6.2 Model: GMV-335WM/B-X

Exploded View:

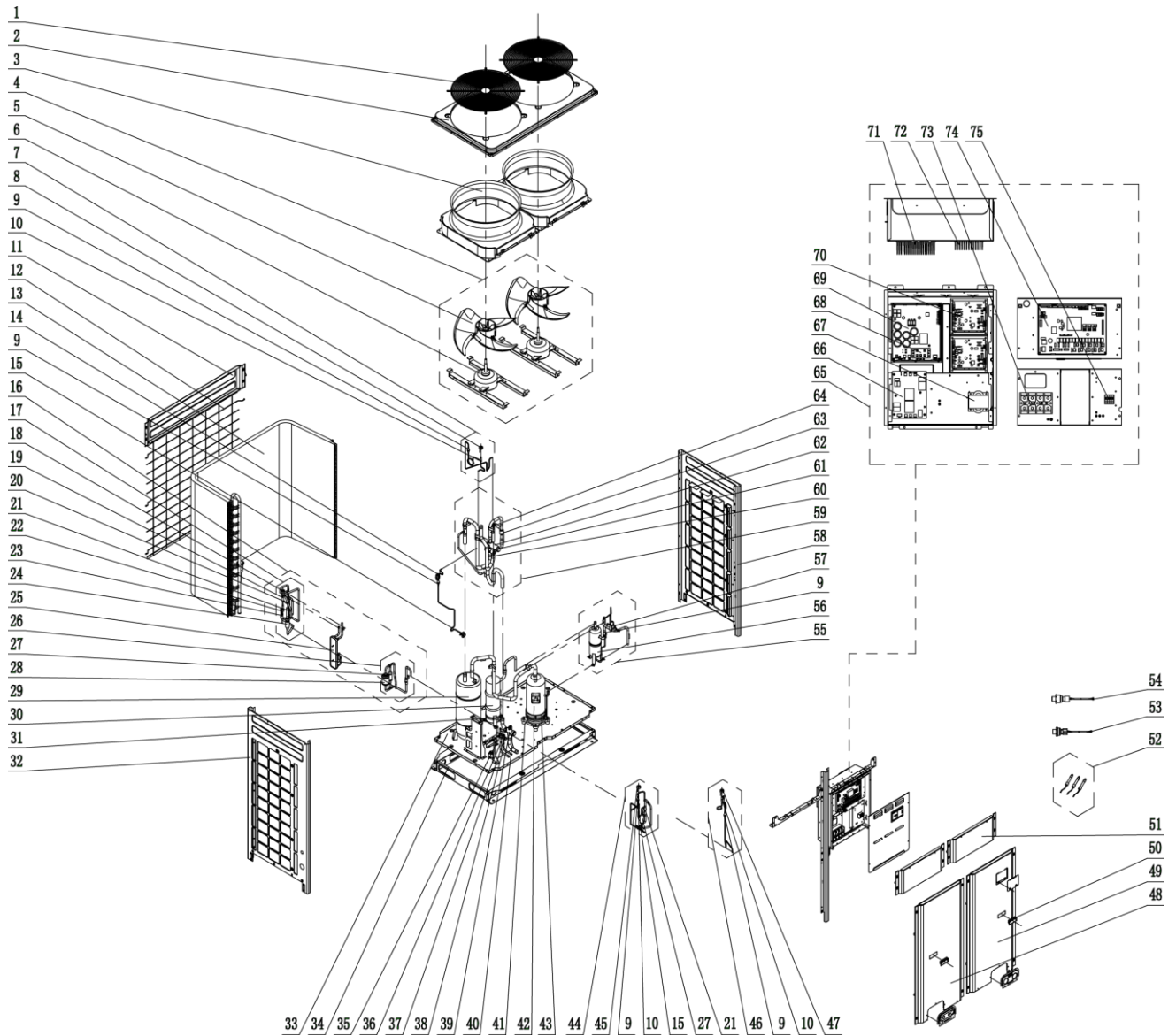

Parts List:

No.	Name of part	GMV-335WM/B-X	
		Product Code	CN851W1300
		Part code	Quantity
1	Rear Grill	01574100002	2
2	Top Cover	01264100006P	1
3	Diversion Circle	10474100002	2
4	Motor for Axial Fan Assy	15404100018	2
5	Axial Flow Fan	10434100002	1
6	Fan Motor	15704124	1
7	Gas By-pass sub- assy	04634100012	1
8	Magnet Coil	4304000420	1
9	Filter	07415200002	1
10	Electromagnetic Valve	43000054	1
11	Rear Top Cover	01264100005P	1

GMV5 DC INVERTER VRF UNITS SERVICE MANUAL

12	Rear Grill	01574100001	1
13	Condenser Assy	01124100096	1
14	Low Pressure Survey Valve Sub-assy	07334100010	1
15	Cut off Valve	07130239	1
16	Throttle Assy	05374100012	1
17	Electric Expansion Valve Sub-Assy	43044100012	1
18	Electric expand valve fitting	4304413203	1
19	Electronic Expansion Valve	07331139	1
20	Discharge Charge Valve	07334100002	2
21	One way Valve	04324001	2
22	Electric expand valve fitting	4304413204	1
23	Electronic Expansion Valve	07334412	1
24	Bidirection Strainer	07210044	1
25	Dry Filter Sub-Assy	00904100012	1
26	Dry Filter Sub-Assy	07314100002	1
27	Gas Tube Filter	072190511	2
28	Dry Filter	07218769	1
29	Gas-liquid Separator	07424138	1
30	Oil Separator	0742418601	1
31	Electric Heater(Compressor)	7651873209	1
32	Right Side Plate	01314713P	1
33	Chassis Sub-assy	01194100069P	1
34	Base Frame Assy	01284100002	1
35	Liquid Valve Sub-Assy	07304100009	1
36	Cut off Valve	07334100013	1
37	Valve	07304100007	1
38	Cut off Valve	07334100011	1
39	Gas Hose Sub-Assy	04574100027	1
40	Cut off Valve	07334100014	1
41	Compressor Gasket	70410226	4
42	Compressor	00204100004	1
43	Electric Heater(Compressor)	7651540713	1
44	Oil Equalizing Pipe Sub-Assy	04224100054	1
45	Magnet Coil	4304000440	1
46	Oil Equalizing Pipe Sub-Assy	04224100059	1
47	Magnet Coil	4304000423	1
48	Left Front Panel	01544100003P	1
49	Right Front Panel	01544100005P	1
50	Handle	26904100016	2
51	Front Top Cover	01264100004P	2
52	Sensor Sub-assy	39004100008G	1
53	Pressure Sensor	32218000009	1
54	Pressure Sensor	32218000008	1
55	Discharge Tube Sub-assy	04534100052	1
56	Oil Separator	07424100023	1
57	Pressure Protect Switch	4602000910	1
58	Left Side Plate	01314712P	1
59	4-Way Valve Sub-Assy	04044100003	1
60	Filter	07218603	1

GMV5 DC INVERTER VRF UNITS SERVICE MANUAL

61	Magnet Coil	4300040030	1
62	4-way Valve	43000339	1
63	One way Valve	07335210	1
64	Nozzle for Adding Freon	06120012	2
65	Electric Box Assy	01394100192	1
66	Filter Board	30228000015	1
67	Reactor	43138000034	1
68	Rectifier	46010604	1
69	Main Board	30228000010	1
70	Main Board	30229009	1
71	Radiator	49018000002	1
72	Radiator	49018000001	2
73	Terminal Board	42010247	1
74	Main Board	30223000005	1
75	Terminal Board	42018000026	1

Above data is subject to change without notice,pls reference the SP in global service website.

3.6.3 Model: GMV-400WM/B-X , GMV-450WM/B-X

Exploded View:

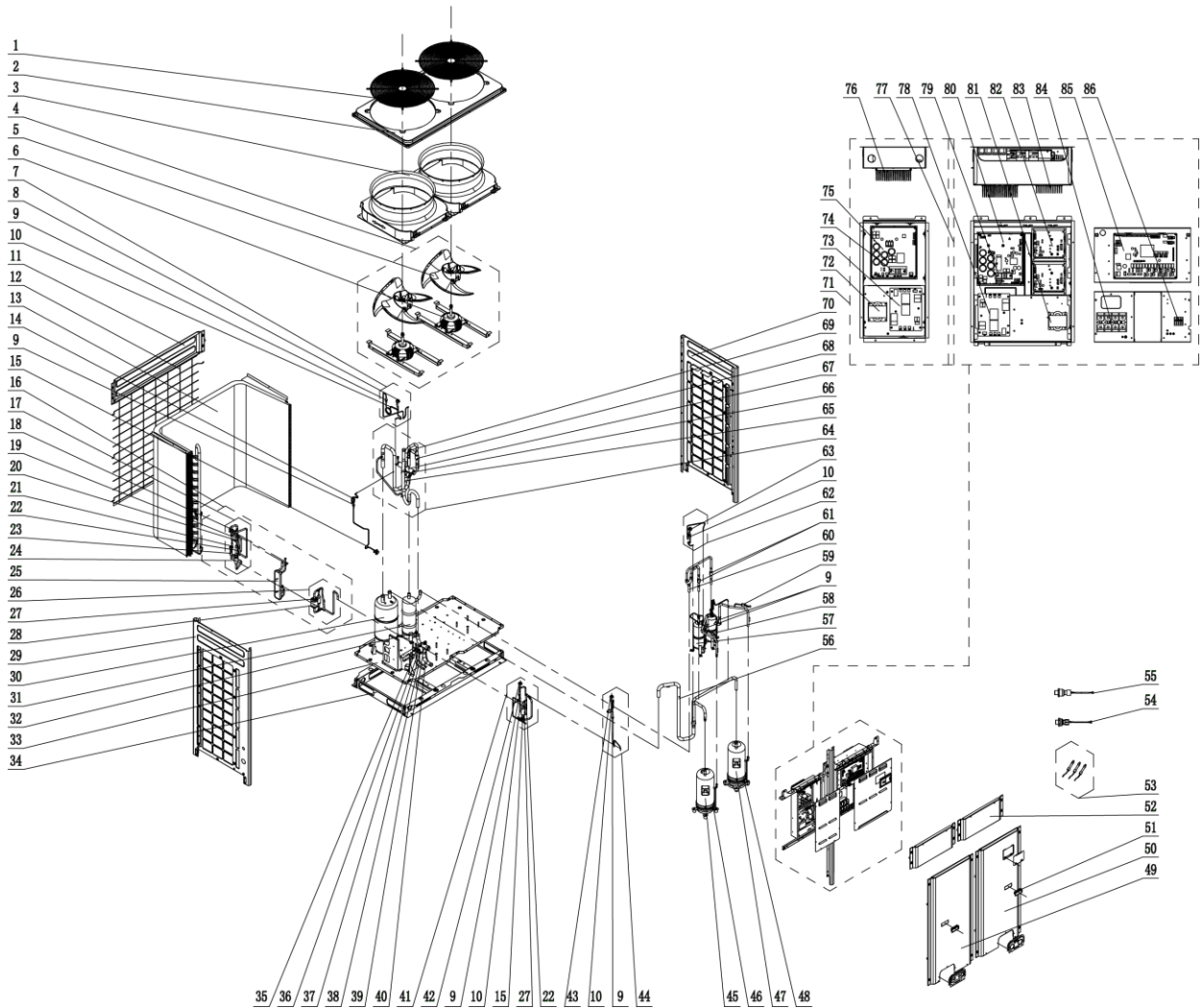

Parts List:

No.	Name of part	GMV-400WM/B-X		GMV-450WM/B-X	
		Product Code	CN851W1310	Product Code	CN851W1320
		Part code	Quantity	Part code	Quantity
1	Rear Grill	01574100002	2	01574100002	2
2	Top Cover	01264100006P	1	01264100006P	1
3	Diversion Circle	10474100002	2	10474100002	2
4	Motor for Axial Fan Assy	15404100018	2	15404100018	2
5	Axial Flow Fan Blade	10434100002	1	10434100002	1
6	Fan Motor	15704124	1	15704124	1
7	Gas By-pass Sub-Assy	04514100036	1	04514100036	1
8	Magnet Coil	4304000420	1	4304000420	1
9	Filter	07415200002	3	07415200002	3
10	Electromagnetic Valve	43000054	1	43000054	1
11	Cover Plate	01264100005P	1	01264100005P	1
12	Rear Grill	01574100001		01574100001	
13	Condenser Assy	0112410009001	1	0112410009001	1
14	Low Pressure Survey Valve Sub-Assy	07334100010	1	07334100010	1

GMV5 DC INVERTER VRF UNITS SERVICE MANUAL

15	Cut-off Valve 1/4	07130239	1	07130239	1
16	Throttle Assy	05374100003	1	05374100003	1
17	Electronic Expansion Valve Fittings	43044100012	1	43044100012	1
18	Electronic Expansion Valve Fittings	4304413204	1	4304413204	1
19	Electronic Expansion Valve	07331139	1	07331139	1
20	Discharge Valve	07334100002	2	07334100002	2
21	Electronic Expansion Valve Fittings	4304413203	1	4304413203	1
22	Check Valve	04324001	2	04324001	2
23	Electronic Expansion Valve	07334412	1	07334412	1
24	Bidirectional Filter	07210044	1	07210044	1
25	Plate-type Heat Exchanger Sub-Assy	00904100007	1	00904100007	1
26	Dry Filter Sub-Assy	07314100002	1	07314100002	1
27	Gas Tube Filter	072190511	1	072190511	1
28	Dry Filter	07218769	1	07218769	1
29	Left Side Plate	01314712P	1	01314712P	1
30	Gas-liquid Separator	07424138	1	07424138	1
31	Oil Separator	0742418601	1	0742418601	1
32	Electrical Heater(Compressor)	7651873209	1	7651873209	1
33	Chassis Sub-Assy	01194100001P	1	01194100001P	1
34	Base Frame Assy	01284100002	1	01284100002	1
35	Cut-off Valve 1/2	07334100013	1	07334100013	1
36	Liquid Valve Sub-Assy	07304100009	1	07304100009	1
37	Cut-off Valve 3/8	07334100011	1	07334100011	1
38	Valve	07304100007	1	07304100007	1
39	Cut-off Valve 1-1/8	07334100014	1	07334100014	1
40	Gas Valve Sub-Assy	07304100008	1	07304100008	1
41	Oil Equalizing Pipe Sub-Assy 1	04224100054	1	04224100054	1
42	Magnet Coil	4304000423	1	4304000423	1
43	Magnet Coil	4304000414	1	4304000414	1
44	Oil Equalizing Pipe Sub-Assy 2	04224100059	1	04224100059	1
45	Compressor and Fittings	00204116	1	00204116	1
46	Electric Heater(Compressor)	7651540714	1	7651540714	1
47	Compressor	00204100002	1	00204100002	1
48	Electric Heater(Compressor)	7651540713	1	7651540713	1
49	Front Panel (Left)	01544100003P	1	01544100003P	1
50	Front Panel (Right)	01544100005P	1	01544100005P	1
51	Handle	26904100016	2	26904100016	2
52	Cover Plate	01264100004P	2	01264100004P	2
53	Sensor Sub-Assy	39008000028G	1	39008000028G	1
54	Pressure Sensor	32218000009	1	32218000009	1
55	Pressure Sensor	32218000008	1	32218000008	1
56	Suction Pipe Sub-Assy	04574100039	1	04574100039	1
57	Oil Separator	07424100023	2	07424100023	2
58	Pressure Switch	4602000911	1	4602000911	1
59	Pressure Switch	4602000912	1	4602000912	1
60	Exhaust Trunk Sub-Assy	04534100012	1	04534100012	1
61	Check Valve	07333700032	2	07333700032	2

GMV5 DC INVERTER VRF UNITS SERVICE MANUAL

62	Gas By-pass Sub-Assy	04514100036	1	04514100036	1
63	Magnet Coil	4304000402	1	4304000402	1
64	4-Way Valve Sub-Assy	04044100019	1	04044100019	1
65	Filter	07218603	1	07218603	1
66	Magnet Coil	4300040030	1	4300040030	1
67	4-way Valve	43000339	1	43000339	1
68	Check Valve	07335210	1	07335210	1
69	Nozzle for Adding Freon	06120012	2	06120012	2
70	Right Side Plate	01314713P	1	01314713P	1
71	Electric Box Assy	01394100104	1	01394100104	1
72	Reactor	4313017401	1	4313017401	1
73	Filter Board	30228122	1	30228122	1
74	Rectifier	46010058	1	46010058	1
75	Main Board	30228609	1	30228609	1
76	Radiator	49018000001	1	49018000001	1
77	Electric Box Assy	01394100085	1	01394100085	1
78	Filter Board	30228000015	1	30228000015	1
79	Rectifier	46010604	1	46010604	1
80	Main Board	30228000010	1	30228000010	1
81	Reactor	43138004	1	43138004	1
82	Main Board	30229009	2	30229009	2
83	Radiator	49018000001	2	49018000001	2
84	Terminal Board	42010247	1	42010247	1
85	Main Board	30223000005	1	30223000005	1
86	Terminal Board	42018000026	1	42018000026	1

Above data is subject to change without notice,pls reference the SP in global service website.

3.6.4 Model: GMV-504WM/B-X, GMV-560WM/B-X, GMV-615WM/B-X

Exploded View:

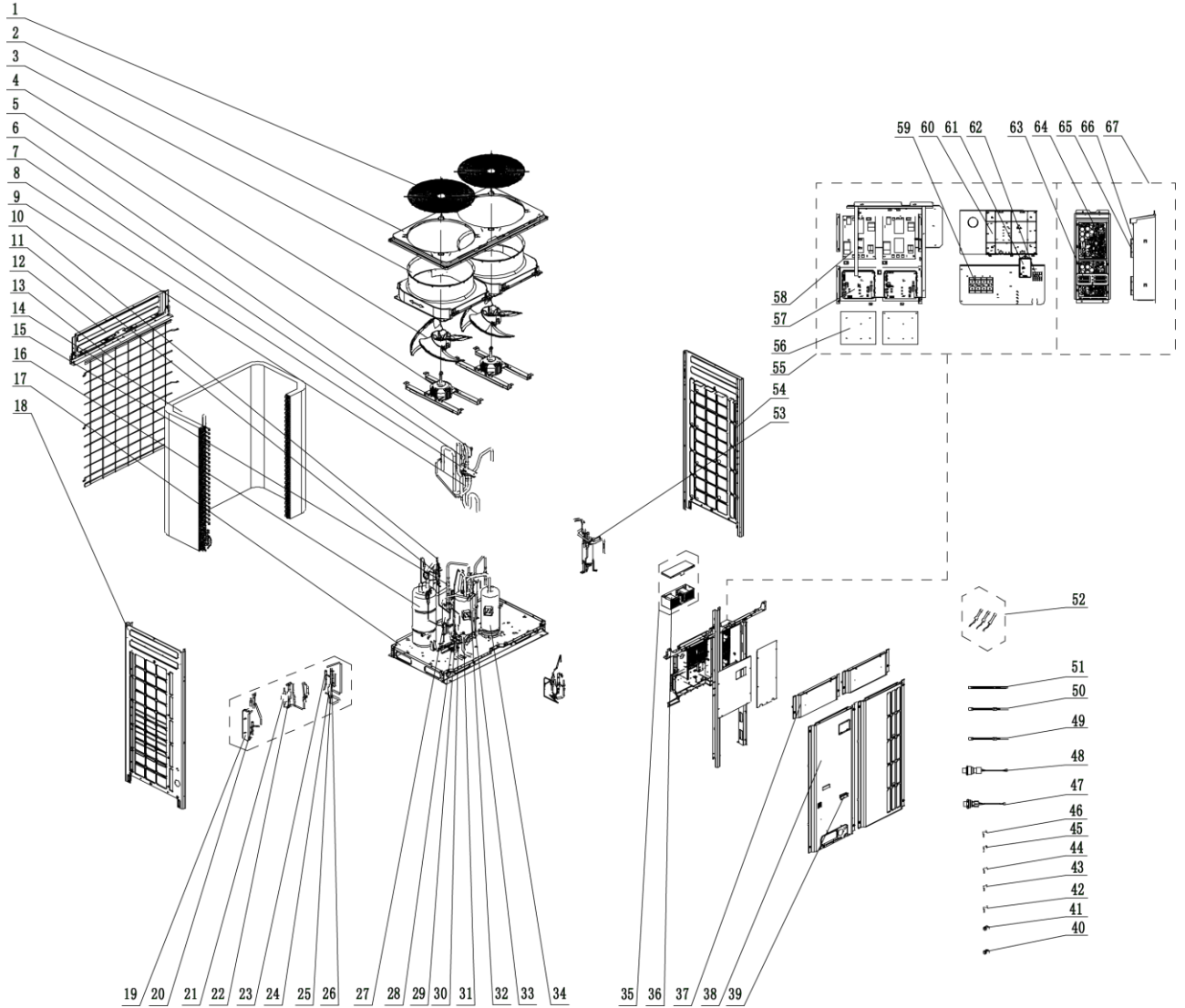

Parts List:

No	Name of part	GMV-504WM/B-X		GMV-560WM/B-X		GMV-615WM/B-X	
		Product Code	CN851W16 10	Product Code	CN851W16 20	Product Code	CN851W16 30
		Part code	Quantity	Part code	Quantity	Part code	Quantity
1	Rear Grill	01574100002	2	01574100002	2	01574100002	2
2	Coping	01264100006 P	1	01264100006 P	1	01264100006 P	1
3	Diversion Circle	10474100002	2	10474100002	2	10474100002	2
4	Axial Flow Fan	10434100002	2	10434100002	2	10434100002	2
5	Fan Motor	15704124	2	15704124	2	15704124	2
6	Nozzle for Adding Freon	06120012	2	06120012	2	06120012	2
7	One way Valve	07335210	1	07335210	1	07335210	1
8	4-way Valve	43000412	1	43000412	1	43000412	1
9	Filter	07218603	1	07218603	1	07218603	1
10	Electromagnetic Valve	43000054	4	43000054	4	43000054	4
11	Strainer	07415200002	6	07415200002	6	07415200002	6
12	Upper Cover	01264100005	1	01264100005	1	01264100005	1

GMV5 DC INVERTER VRF UNITS SERVICE MANUAL

	Plate (back)	P		P		P	
13	Rear Grill	01600150038 1	1	01600150038 1	1	01600150038 1	1
14	Condenser Assy	01124100169 01	1	01100250016 201	1	01100250016 201	1
15	One Way Valve	07333700032	2	07333700032	2	07333700032	2
16	Gas-liquid Separator	07424138	1	07424138	1	07424138	1
17	Chassis Sub-assy	01194100070 P	1	01194100070 P	1	01194100070 P	1
18	Left Side Plate	01205550002 2P	1	01205550002 2P	1	01205550002 2P	1
19	Plate-type Heat Exchanger	00904100004	1	00904100004	1	00904100004	1
20	Electronic Expansion Valve	07334412	1	07334412	1	07334412	1
21	Dry Filter	07218769	1	07218769	1	07218769	1
22	Gas Tube Filter	072190511	2	072190511	2	072190511	2
23	Electronic Expansion Valve	07331139	1	07331139	1	07331139	1
24	Strainer	07210037	1	07210037	1	07210037	1
25	One way Valve	04324001	2	04324001	2	04324001	2
26	Discharge Charge Valve	07334100002	2	07334100002	2	07334100002	2
27	Oil Separator	07424100023	2	07424100023	2	07424100023	2
28	Cut off Valve	07130239	2	07130239	2	07130239	2
29	Cut off Valve	07334100053	1	07334100053	1	07334100053	1
30	Cut off Valve	07334100011	1	07334100011	1	07334100011	1
31	Cut off Valve	07334100014	1	07334100014	1	07334100014	1
32	Pressure Protect Switch	4602000911	1	4602000911	1	4602000911	1
33	Oil Separator	0742418601	1	0742418601	1	0742418601	1
34	Compressor and Fittings	00204100008	2	00204100008	2	00204100008	2
35	Reactor Sub-assy	01394100449	1	01394100449	1	01394100449	1
36	Reactor	4313017403	2	4313017403	2	4313017403	2
37	Top Cover (front)	01264100004 P	2	01264100004 P	2	01264100004 P	2
38	Left Front Panel	01206250004 0P	1	01206250004 0P	1	01206250004 0P	1
39	Handle	26904100016	1	26904100016	1	26904100016	1
40	Electric expand valve fitting	4304413203	1	4304413203	1	4304413203	1
41	Electric Expand Valve Fitting	4304413204	1	4304413204	1	4304413204	1
42	Magnet Coil	4304000414	1	4304000414	1	4304000414	1
43	Magnet Coil	4304000440	1	4304000440	1	4304000440	1
44	Magnet Coil	4304000423	1	4304000423	1	4304000423	1
45	Magnet Coil	4300040030	1	4300040030	1	4300040030	1
46	Magnet Coil	4304000420	1	4304000420	1	4304000420	1
47	Pressure Sensor	32218000009	1	32218000009	1	32218000009	1
48	Pressure sensor	32218000008	1	32218000008	1	32218000008	1
49	Electric Heater(Compressor)	7651540713	1	7651540713	1	7651540713	1
50	Electric Heater(Compressor)	7651540714	1	7651540714	1	7651540714	1



GMV5 DC INVERTER VRF UNITS SERVICE MANUAL

51	Electrical Heater(Compressor)	7651873209	1	7651873209	1	7651873209	1
52	Sensor Sub-assy	39008000102G	1	39008000102G	1	39008000102G	1
53	Pressure Protect Switch	4602000912	1	4602000912	1	4602000912	1
54	Right Side Plate	012056500021P	1	012056500021P	1	012056500021P	1
55	Electric Box Assy	01394100426	1	01394100426	1	01394100426	1
56	Radiator	49018000001	2	49018000001	2	49018000001	2
57	Main Board	30223000032	2	30223000032	2	30223000032	2
58	Filter Board	30223000025	2	30223000025	2	30223000025	2
59	Terminal Board	42010247	1	42010247	1	42010247	1
60	Main Board	30223000041	1	30223000041	1	30223000041	1
61	Communication Interface Board	30118000068	1	30118000068	1	30118000068	1
62	Terminal Board	42018000026	1	42018000026	1	42018000026	1
63	Terminal Board	42018000577	2	42018000577	2	42018000577	2
64	Main Board	30223000039	2	30223000039	2	30223000039	2
65	Radiator	49018000088	2	49018000088	2	49018000088	2
66	Radiator	49018000080	2	49018000080	2	49018000080	2
67	Electric Box Assy	01394100373	1	01394100373	1	01394100373	1

Above data is subject to change without notice,pls reference the SP in global service website.

# Chapter 5 Remote Control

## 1 Engineering Debugger

### 1.1 Overview

With quick increase of comprehensive constructions and large buildings, central air conditioning systems of the buildings are not only increased in number and diversified in model but also sparsely distributed, which makes centralized management and maintenance difficult to realize. Gree Debugger, integrated with electronic communication technology and PC software technology, helps monitor, control, and debug central air conditioning units all round, making sparse distribution not an issue and realizing centralized control and management. Managers, needless to go to the site to set and manage all units, can perform running state query, unit start/stop, temperature adjustment, and other operations using a PC, improving working efficiency and reducing manpower, material, and management input.

At present, Gree Debugger can be used to comprehensively monitor and control Gree multi units. So long as users have a PC, they can monitor and control air conditioning units through the software. Gree Debugger is an effective intelligent management tool for air conditioning systems and also a tool for engineering setup and after-sale debugging. With Gree Debugger, users can debug air conditioners on site, understand units' running state, and conveniently analyze units' health conditions, not only improving users' working efficiency and reducing maintenance difficulty and cost but also improving customers' service quality and speed.

## 1.2 System Networking

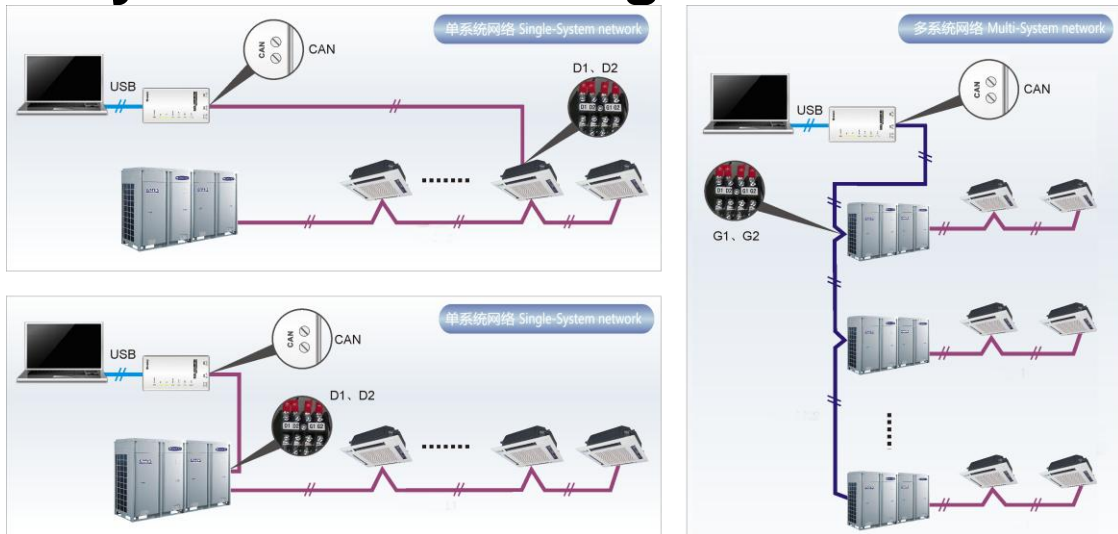

Gree Debugger is applicable to both single-system network and multi-system network. In a single-system network, the software can control both IDUs and ODUs. In a multi-system network, however, the software can control the master ODU only.

### Composition of System Network

From the network topology, it can be seen that Gree debugging network is composed of three parts:

Control PC part in the monitor room, including Gree Debugger and USB Converter Driver installed in the PCs.

USB data conversion part, mainly converts air conditioning units' communication mode into PC recognizable mode. Devices include USB data converters and USB data lines.

Air conditioning unit part, mainly composed of air conditioning units, including ODUs, IDUs, and lines. If the lines are not long enough, the transfer board accompanied with Gree Debugger can help connect the lines together. In a single-system network, the converter can be connected to an IDU or an ODU. In a multi-system network, however, the converter can be connected to a master ODU only.

# 1.3 Hardware

## 1.3.1 List of Parts

Name	Type	BOM	Remark
USB data converter	ME40-00/B	30118000001	Converts unit communication mode into PC recognizable communication mode
Debugger suite (disk)	DE40-33/A(C)	36400000003	This disk contains the Gree Debugger, monitor software, USB driver, and USB converter configuration software
USB data line	\	40020082	A line connecting a PC with the converter over the USB interface
COM interface board	\	30118015	This board serves to connect units with control PCs when they are too distant to communicate
Connecting line (1 m)	\	4001023229	A 4-core line connecting units with the converter
Connecting line (5.5 m)	\	4001023214	A 4-core line connecting units with the converter
User manual	\	64134100023	Instructions

## 1.3.2 USB Data Converter

### 1.3.2.1 Function

The USB data converter converts communication mode of the air conditioning units, for example, RS485, HBS, and CAN into a mode that is recognizable through PC's USB interface.

### 1.3.2.2 Appearance

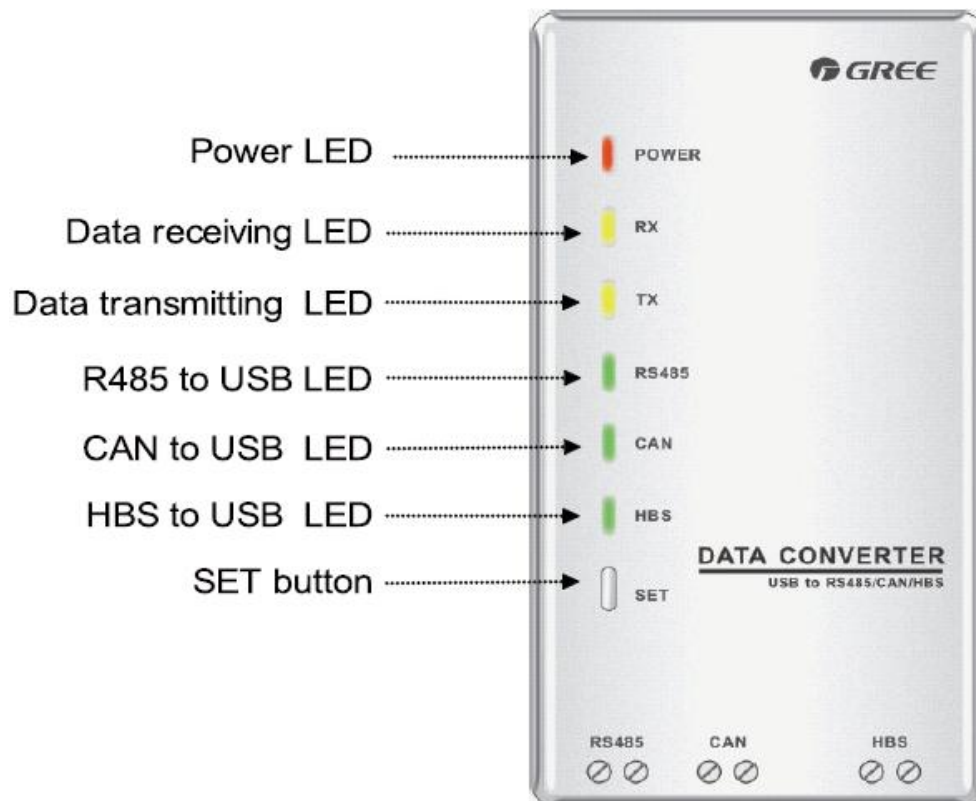

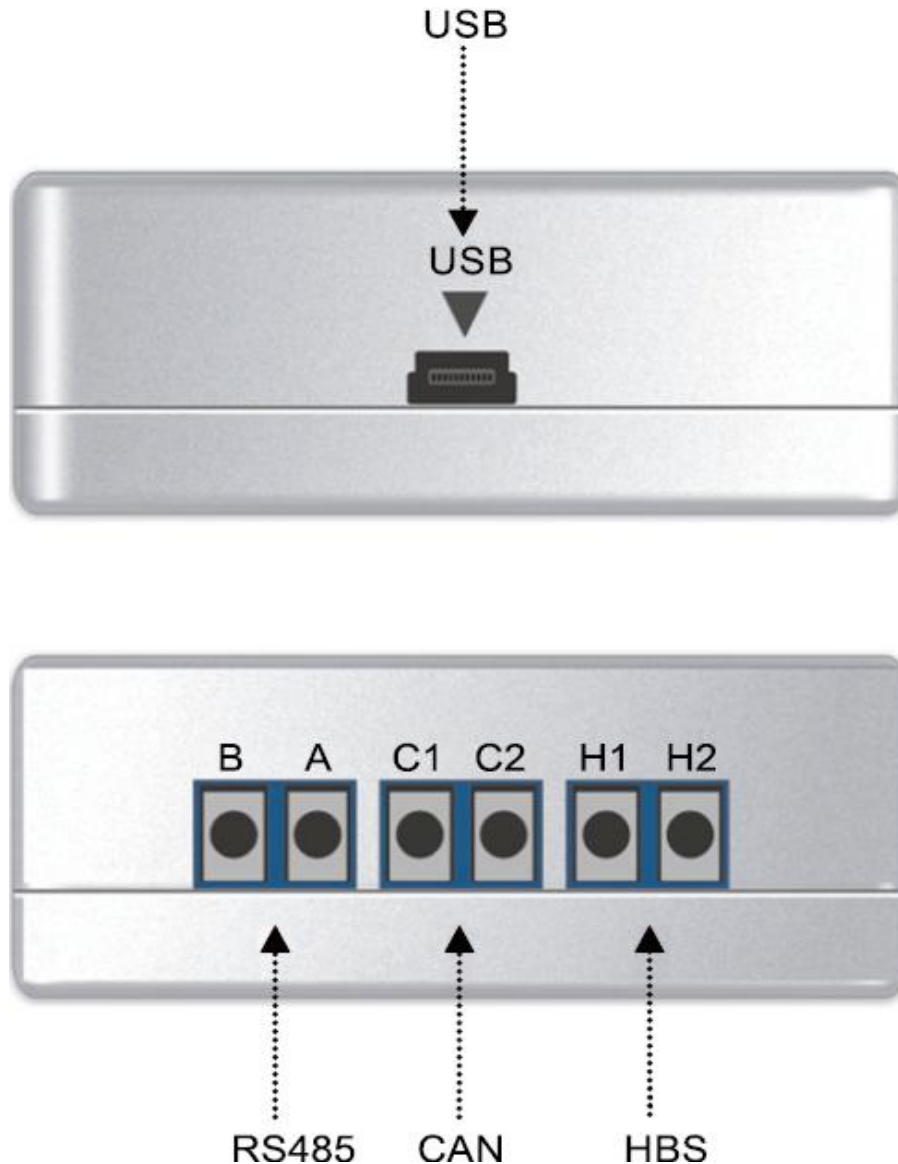

### 1.3.2.3 LEDs and Interfaces

**Power LED:** a red LED. When it is on, it indicates that the converter is normally supplied with power; when it is off, it indicates that the converter's power supply is abnormal.

**Communication LEDs:** two yellow LEDs. When a PC is delivering data, the data transmitting LED will flash; when an air conditioning unit is uploading data to the PC, the data receiving LED will flash.

**Function LEDs:** three green LEDs:

If the RS485 to USB LED is steady on, it indicates that the converter is working in RS485 mode.

If the CAN to USB LED is steady on, it indicates that the converter is working in CAN mode.

If the HBS to USB LED is steady on, it indicates that the converter is working in HBS mode.

**USB interface:** connects to a USB data line.

**CAN interface:** When air conditioners work in CAN mode, they are connected to the converter over this CAN interface. This interface is not distinguished by polarity. Thus, the two contacts C1 and C2 can be used interchangeably.

**HBS interface:** When air conditioners work in HBS mode, they are connected to the converter over this HBS interface. This interface is not distinguished by polarity. At present, Gree Debugger and monitor software do not support this interface.

**RS485 interface:** When air conditioners work in RS485 mode, they are connected to the converter over this RS485 interface. This interface is distinguished by polarity. Thus, the two contacts A and B cannot be used interchangeably.

### 1.3.2.4 Precautions

The converter should be installed indoors and prevented from being hit. It is recommended that the converter is installed in the monitor room with PCs.

The converter does not need to be connected to a power supply. It is powered by the PC via the USB interface.

### 1.3.3 COM Interface Board

This board mainly transfers data. Providing a transfer function, the board serves to connect units with control PCs when they are too distant to communicate.

### 1.3.4 Lines

#### 1.3.4.1 USB Data Line

A USB data line is connecting to a USB interface of a PC at one end and to another USB interface of a converter at the other end. See the following figure:

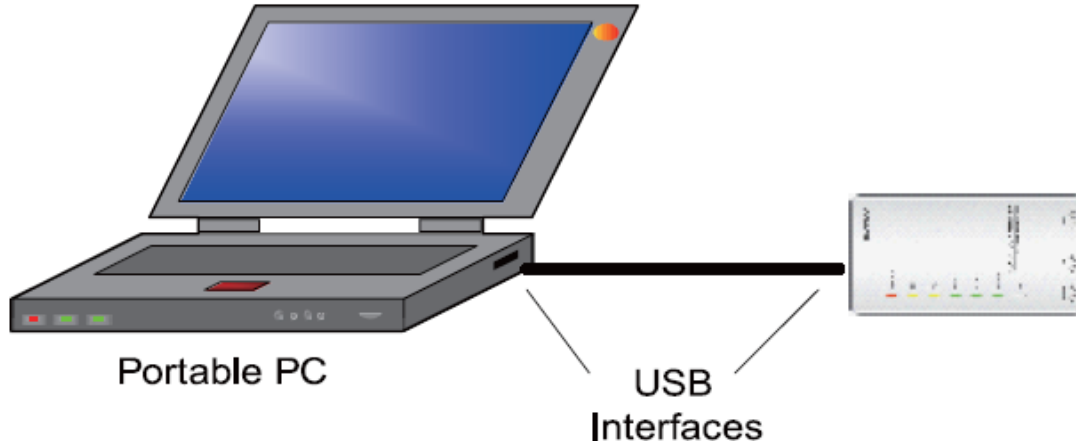

#### 1.3.4.2 Connecting Line

Gree Debugger is accompanied with two lines: 1 m and 5.5 m. They are completely the same except the length. The line is connecting to the COM interface of an air conditioning unit at one end and to the CAN interface of a converter at the other end, as shown in the following figure. The air conditioning unit can be either an IDU or an ODU.

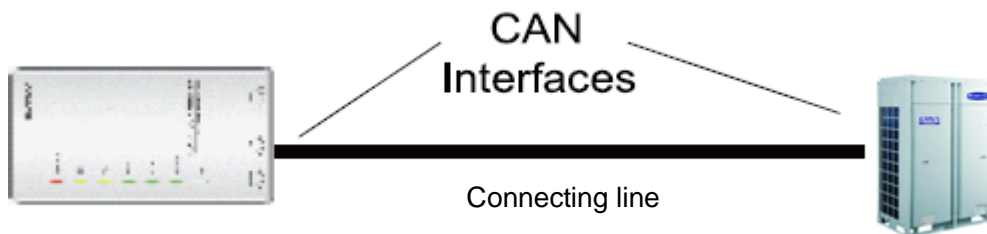

# 1.4 Software Setup

## 1.4.1 Prerequisites

### 1.4.1.1 PC Configuration

Memory	Min: 1 GB Recommended: 2 GB or larger
Hardware	10 GB available
CPU	Core 2 or later versions Min: 1 GHz Recommended: 2 GHz or higher
OS	Windows Server 2003 SP3 or later versions Windows XP SP3 or later versions Windows Vista Windows 7

### 1.4.1.2 Running the Disk

Make sure you have the administrator permission and the PC has been configured with a driver. Put the disk into the driver. If it is running automatically, the following page will appear. If not, double click the "Launcher.exe" file to display the page.



If it is the first time to use Gree Debugger, the following software needs to be installed: .Net Framework 4.0, USB Converter Driver, Access Driver (required for versions earlier than Office 2007), and Gree Debugger.

### 1.4.2 Installation Flowchart

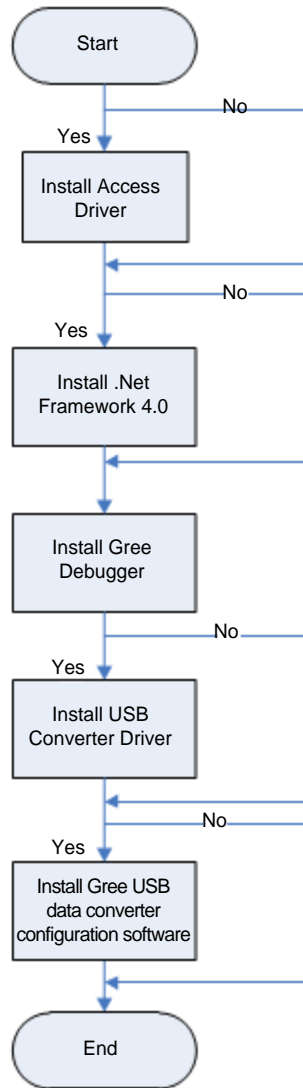

This is a simplified software setup procedure. For details, read the following section.

### 1.4.3 Installation Procedure

#### 1.4.3.1 Installing .Net Framework 4.0

If your PC has been installed with .Net Framework 4.0 or later version, skip this step. Otherwise, click “Install .Net Framework 4.0”.



Loading file.



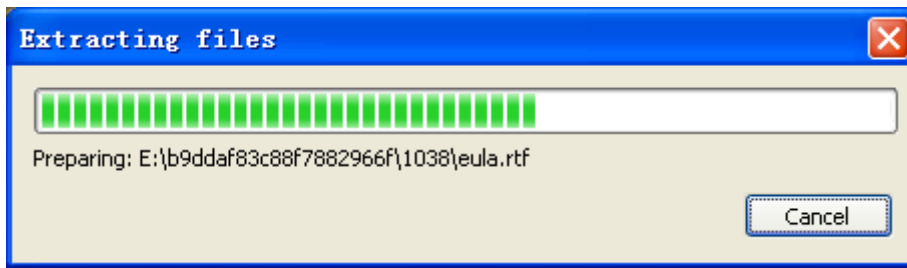

Check "I have read and accept the license terms" and click "Install".

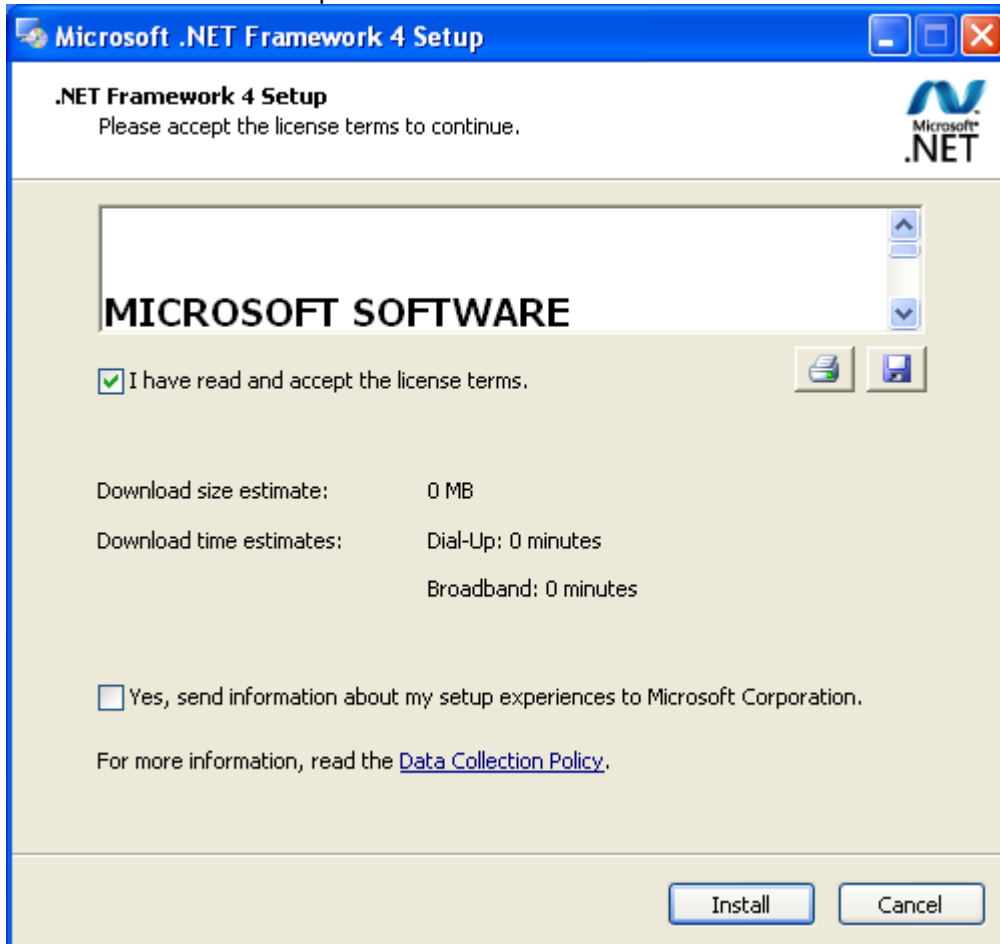

Installing.

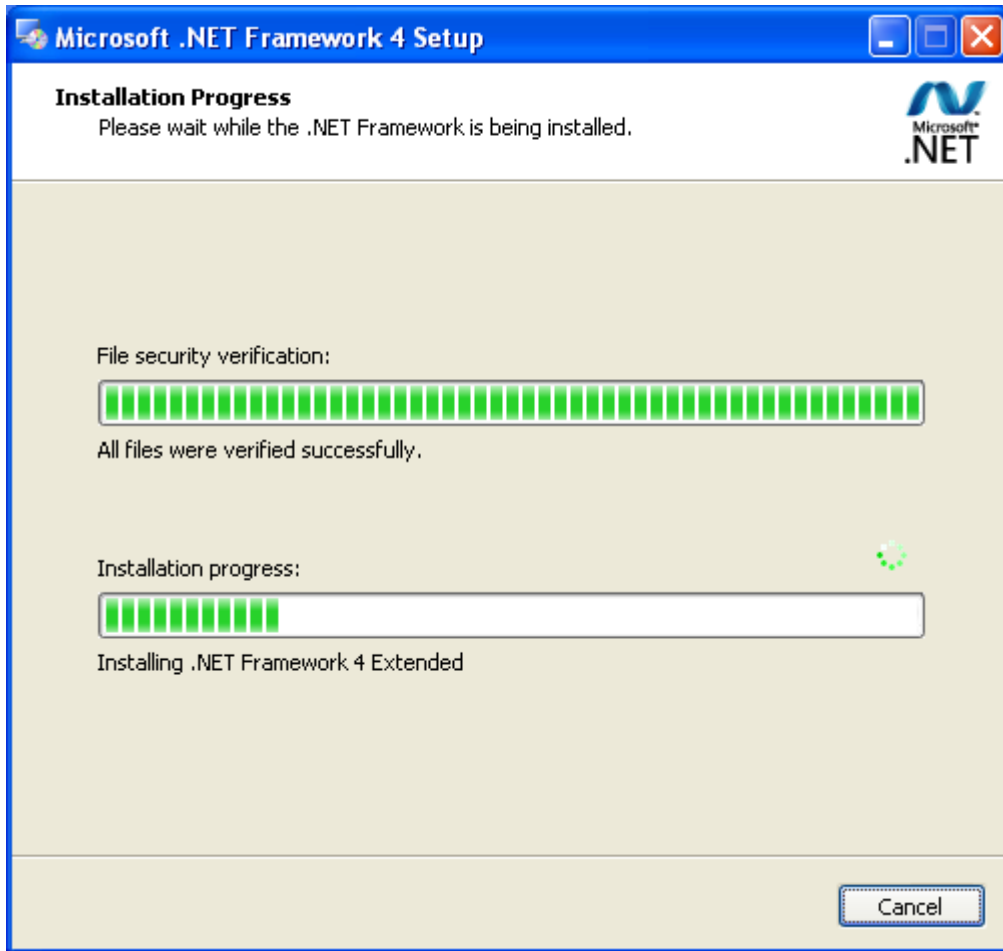

Click "Finish".

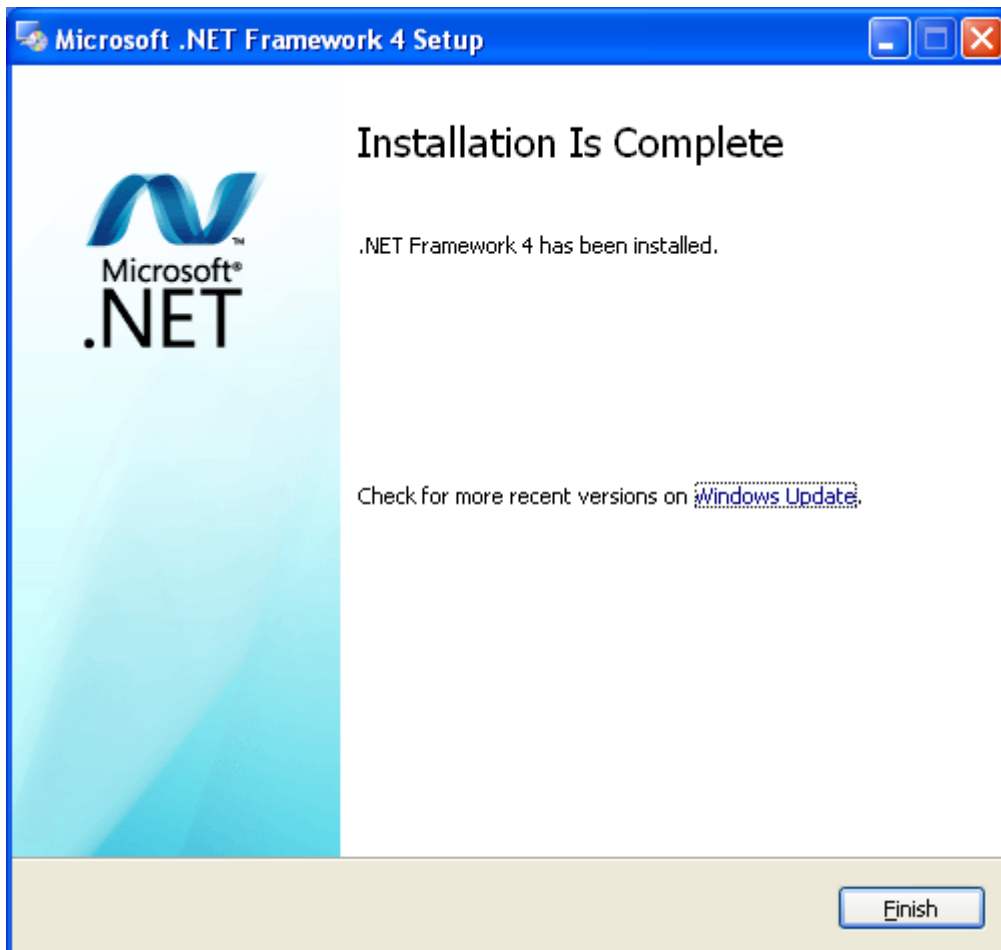

#### 1.4.3.2 Installing Access Driver

Before the Gree Debugger can run, install the Access Driver (required for versions earlier than Office 2007). Click "Install Access Driver".



Click "Next".

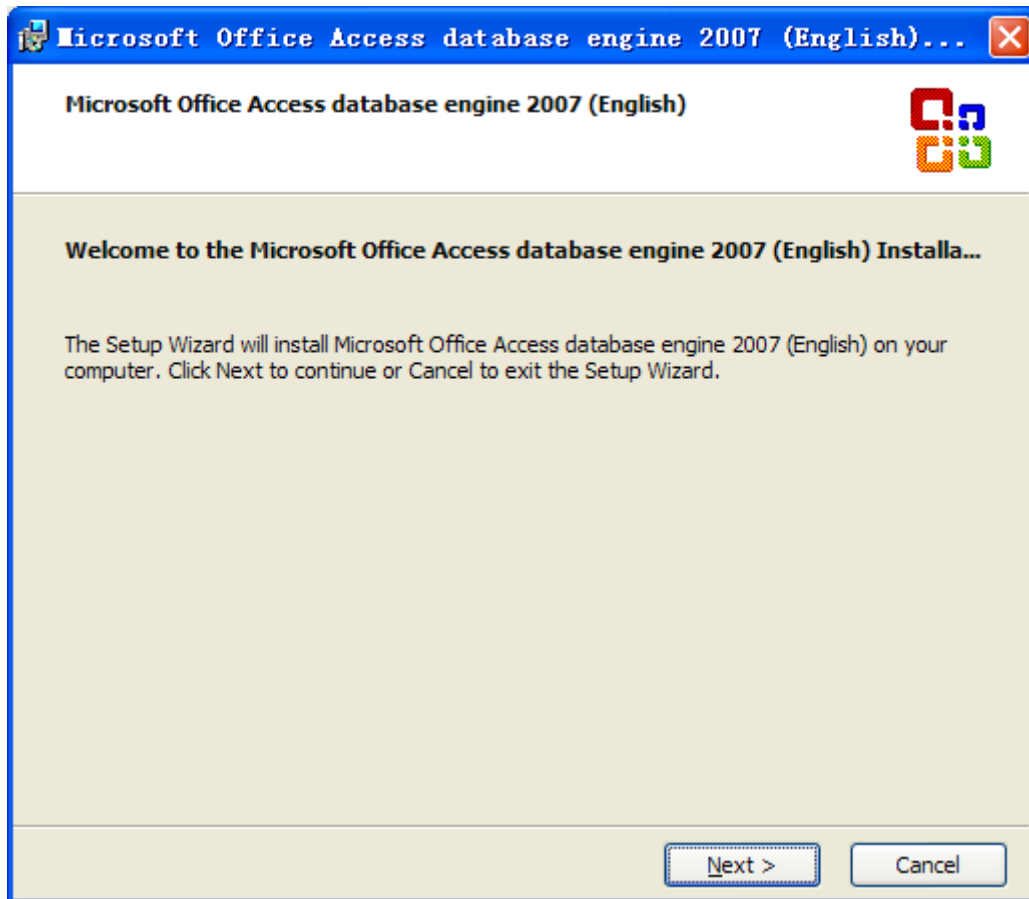

Check "I accept the terms in the License Agreement" and click "Next".



Click "Browse" to select a path. If you want to use the default path, click "Install".

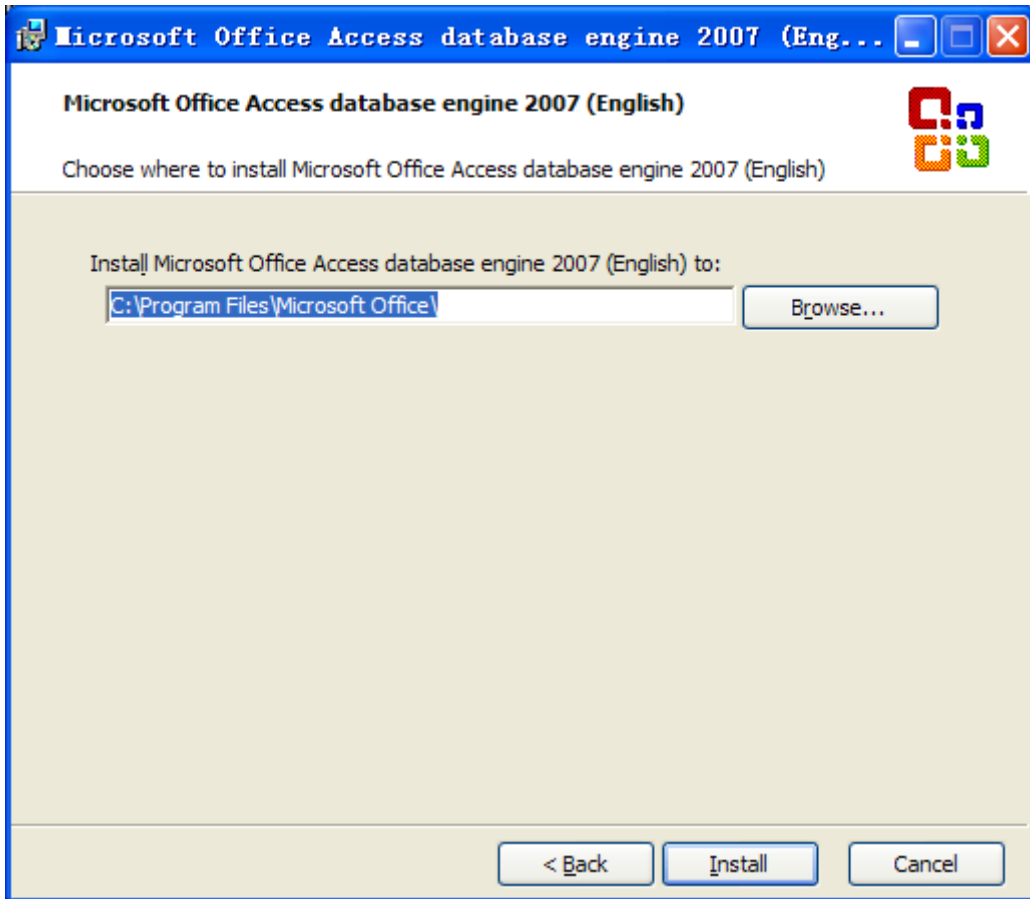

Installing.

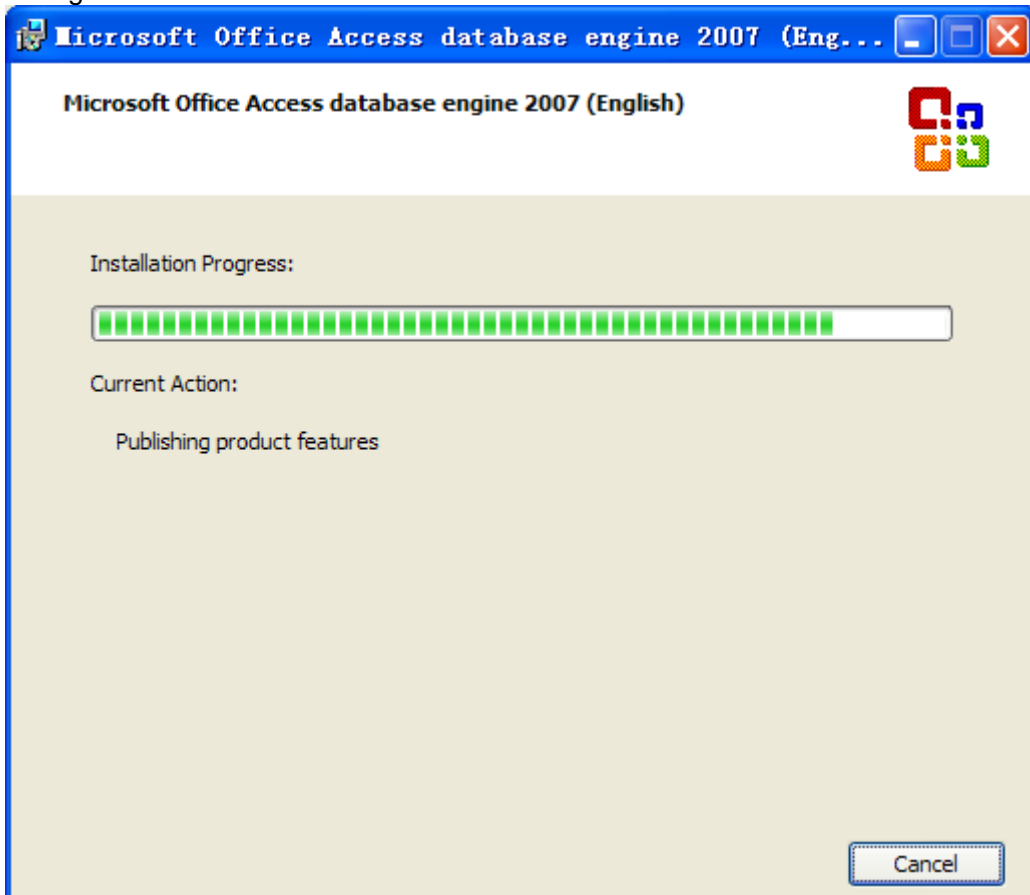

Click "OK".



#### 1.4.3.3 Installing Gree Debugger

Before installing Gree Debugger, make sure your PC has been installed with .Net Framework 4.0 or later version. Click "Install Gree Debugger".



Click "Next".

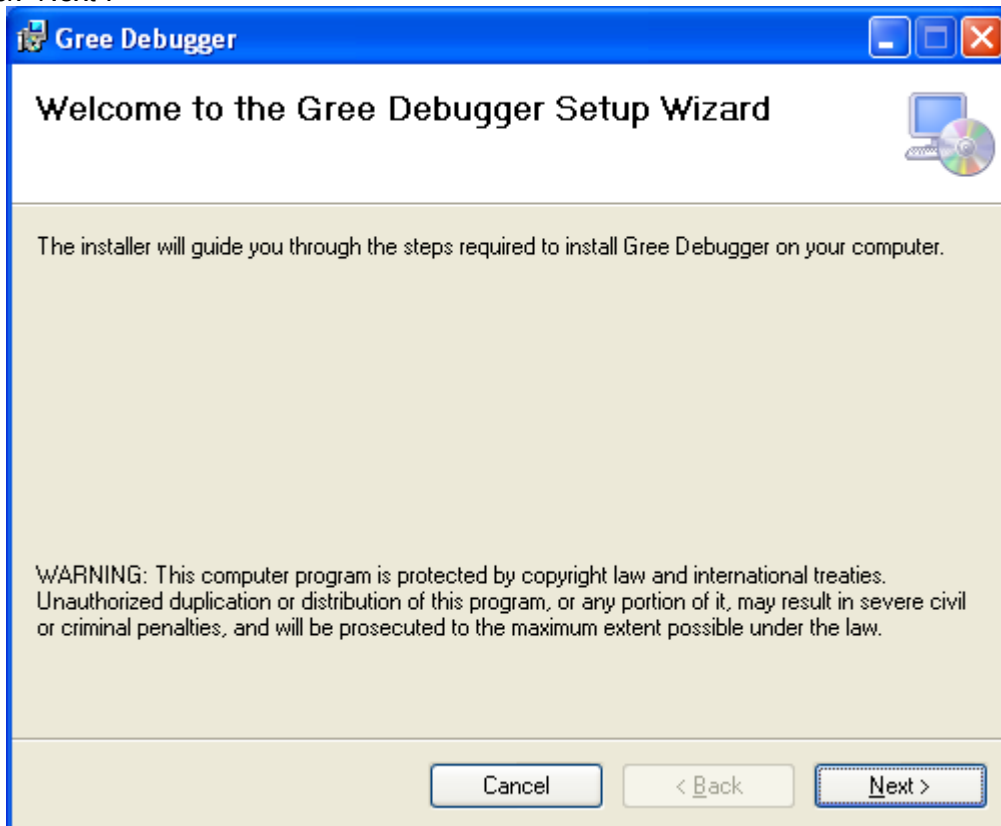

Click "Browse" to select a path. If you want to use the default path, click "Next".

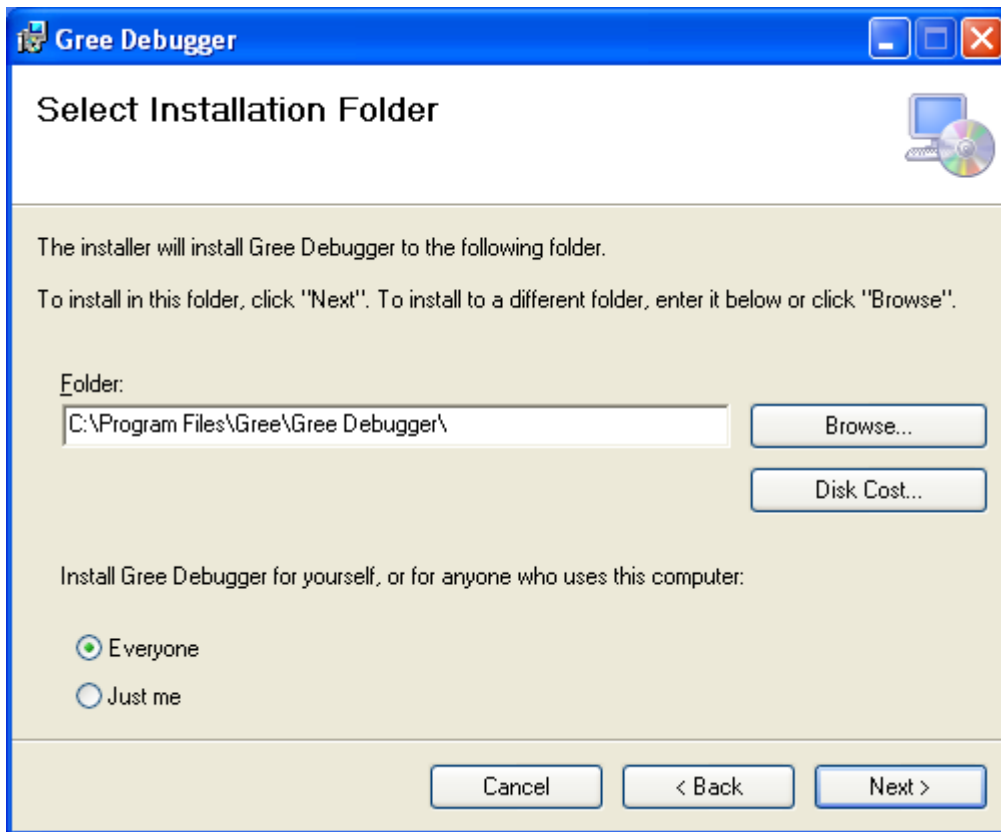

Click "Next".

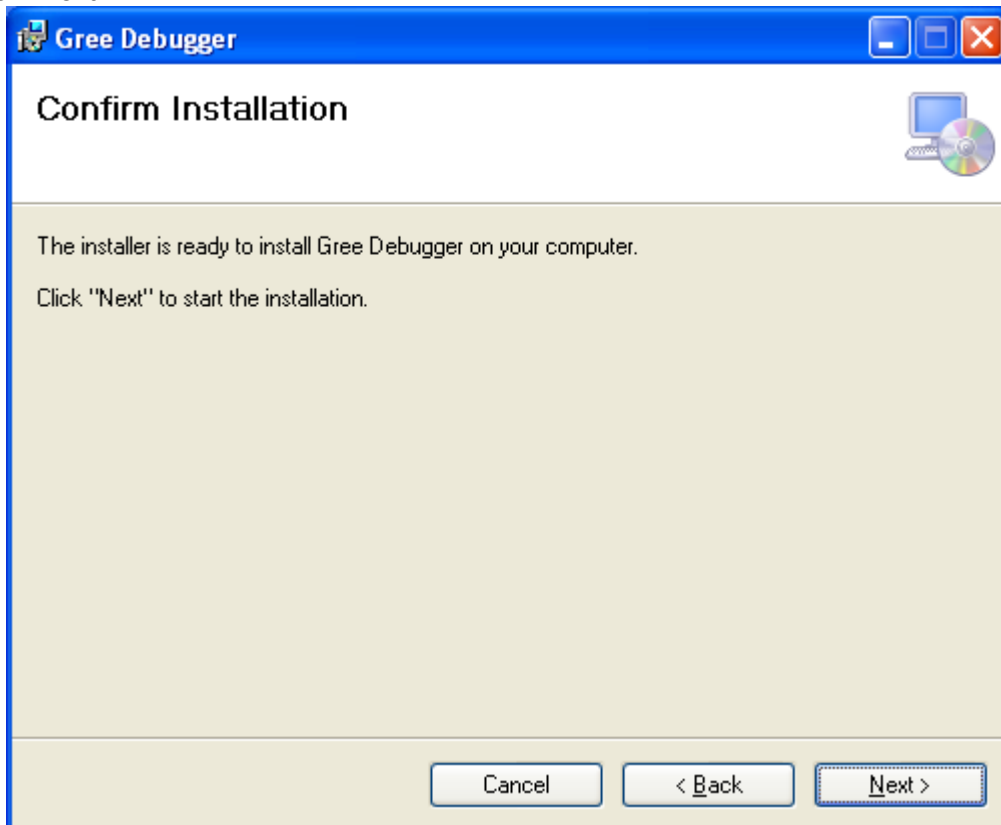

Installing.

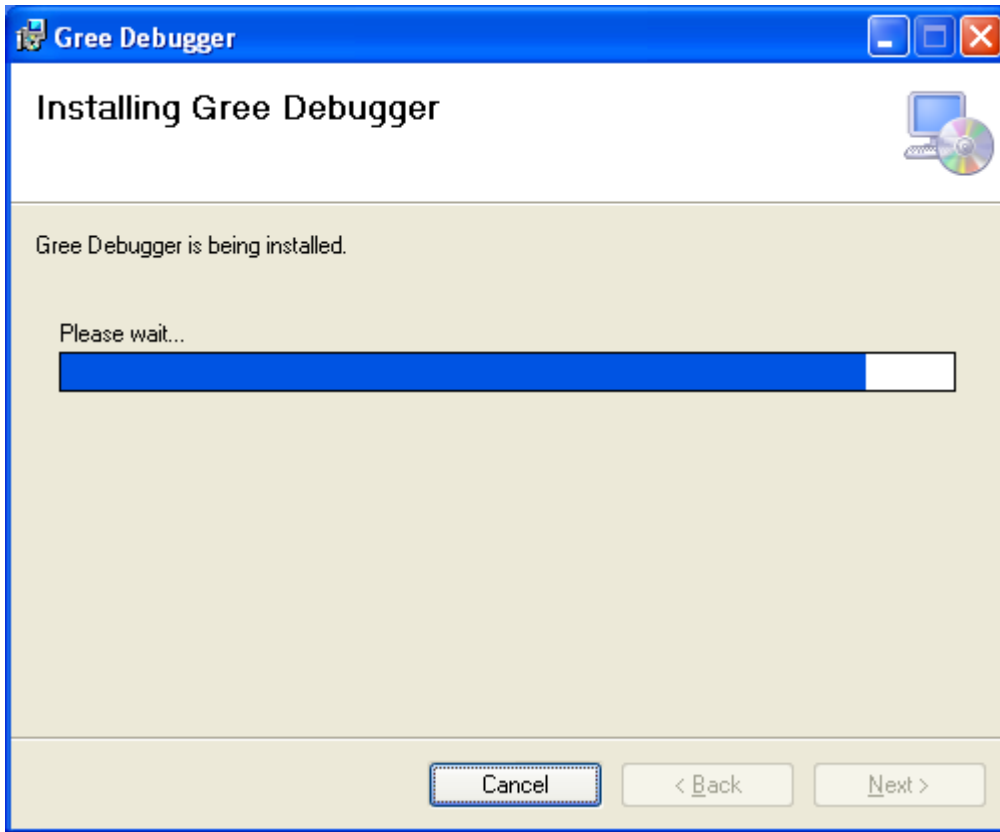

Click "Close".

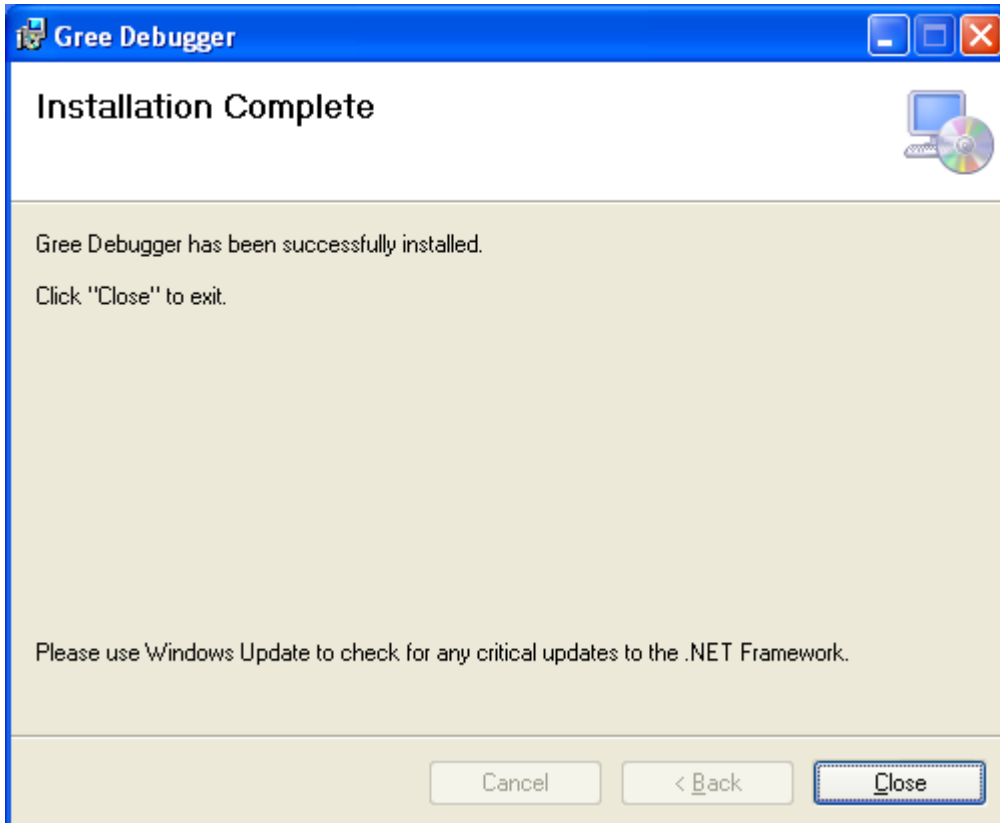



# 1.5 Using Debugger

## 1.5.1 Major Functions

### 1.5.1.1 One-Click Engineering Debug

Engineering debug personnel can use this software to debug units based on engineering debug logic by one-click operation. The minute you deliver a debug command through the software, units begin automatic debug step by step. When the units pass debug of a step, the step is automatically checked green. If they fail this step, it will be checked red.

### 1.5.1.2 All-Round Monitor and Health Analysis

All-round monitor on the air conditioning systems, including functions, devices, and parts is supported. Intuitive and clear display facilitates users to understand running of the entire systems and units.

### 1.5.1.3 Real-Time Control and Running Mode Adjustment

Air conditioner operation time and requirement on the air conditioners vary with geographical locations. Users can adjust parameters of air conditioning units through a PC based on the actual situation of an area, including start/stop, temperature, airflow speed, and mode. Gree Debugger also enables users to set and query parameters for ODUs and gateways.

### 1.5.1.4 Other Functions

Gree Debugger also instructs users to connect units, and allows users to capture screens, open database files, rebuild database, and modify database file saving path.

## 1.5.2 How to Use Gree Debugger

### 1.5.2.1 Viewing Unit Parameters

Run Gree Debugger.



On the initial page, select a language and unit. If you want to use default settings, click “OK” to enable Gree Debugger.

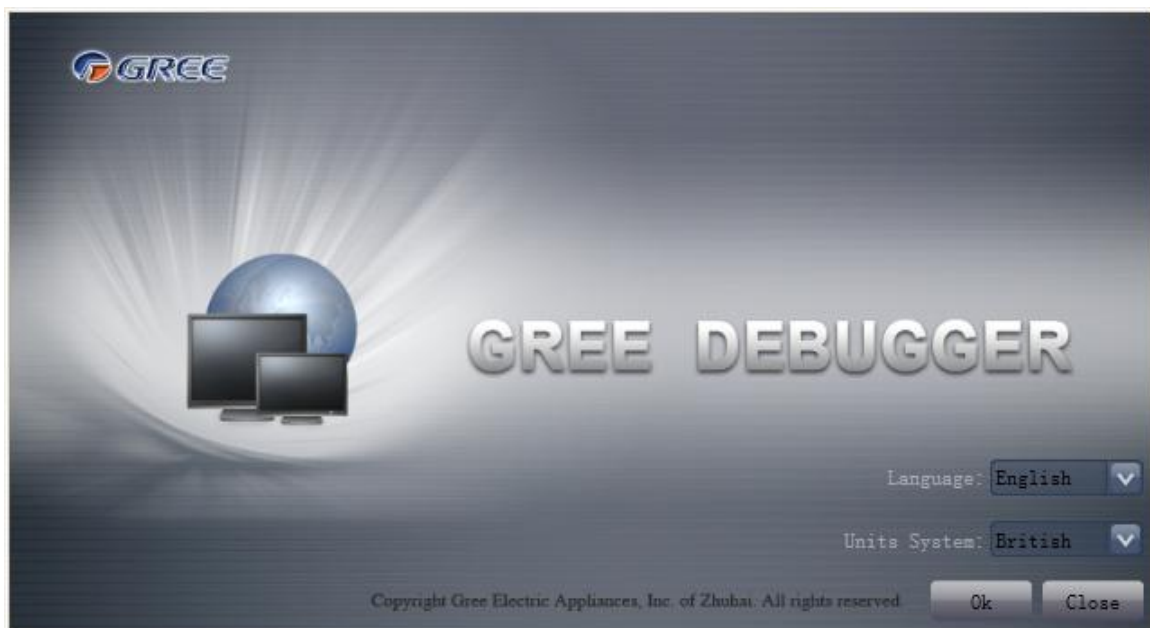

Select a language.

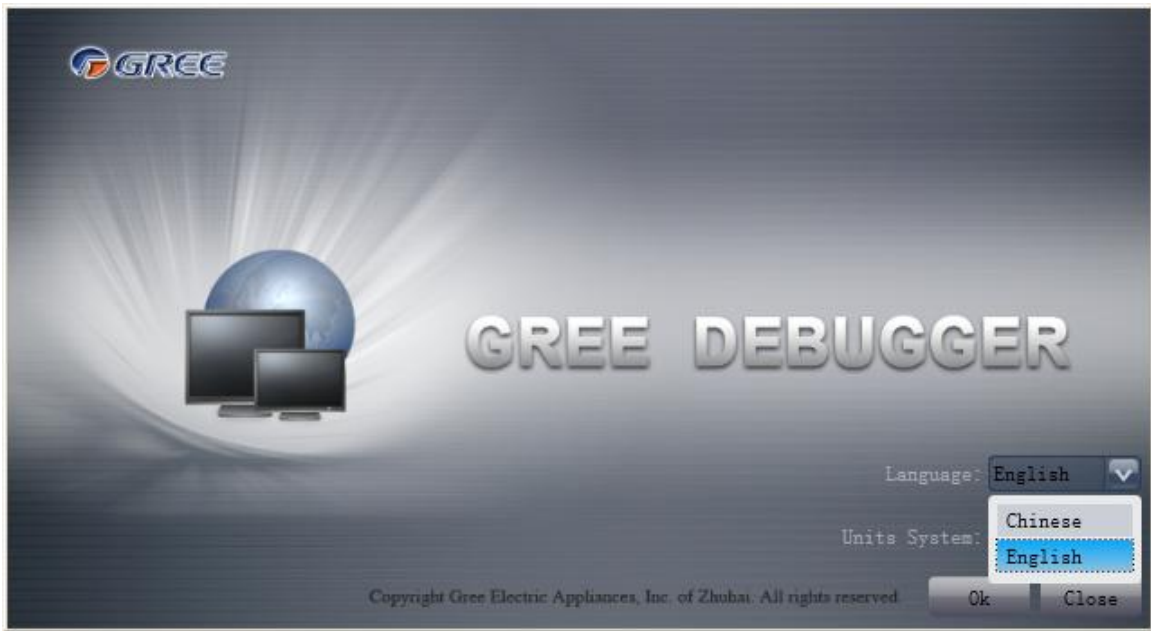

Select a unit.

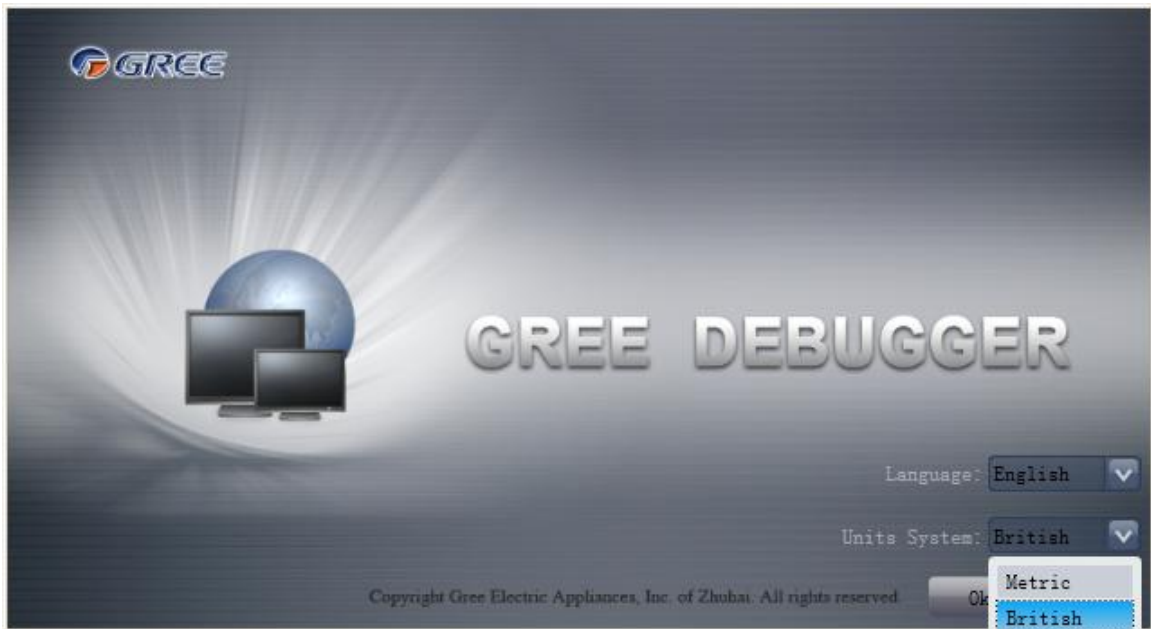

If units you want to monitor have been connected and normally communicating, and COM interface and protocol are set, click “Connect” to access the parameter page. If not, follow the figure below to connect the units.

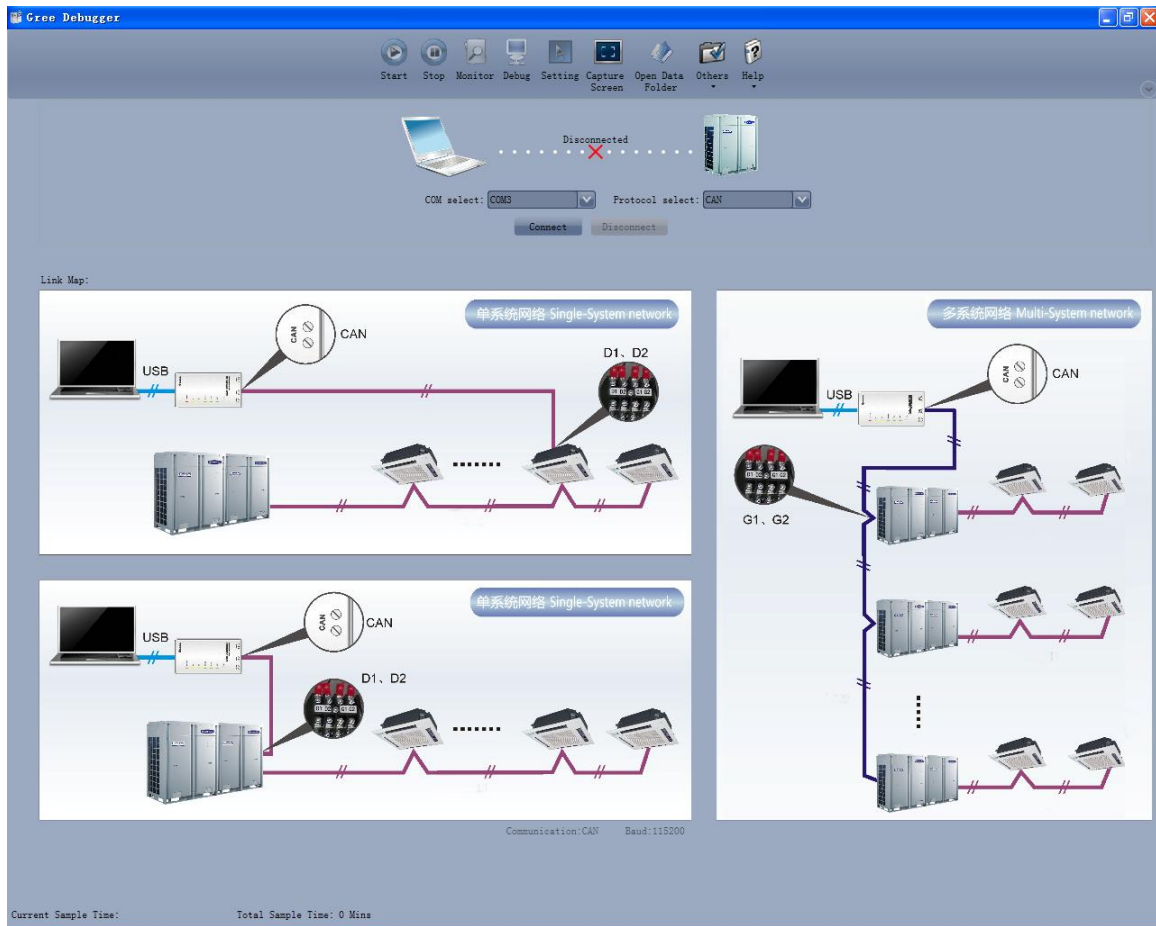

Set COM interface. Cree Debugger will automatically detect available serial ports of your PC. You can select one of them.

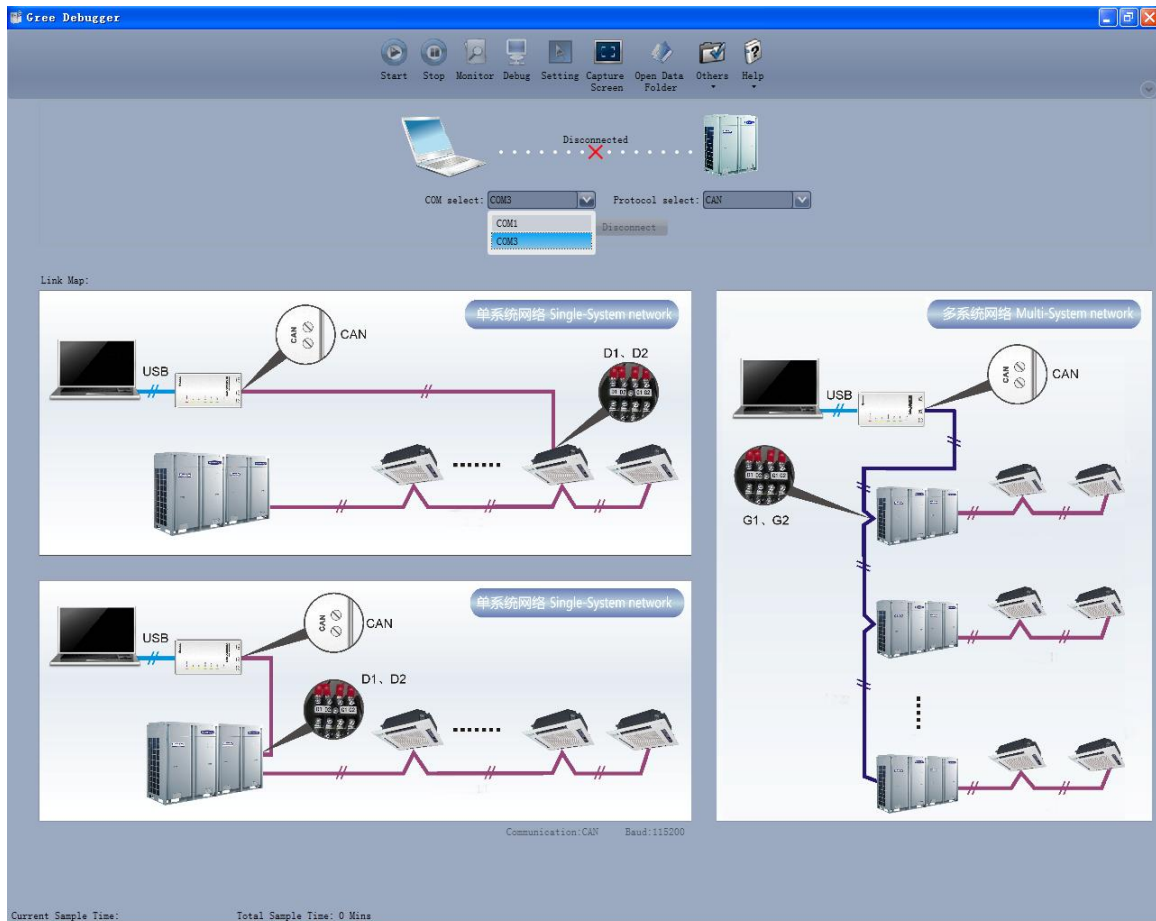

Set protocol. This is to choose a communication mode of your air conditioning units. At present, CAN is the proper communication mode.

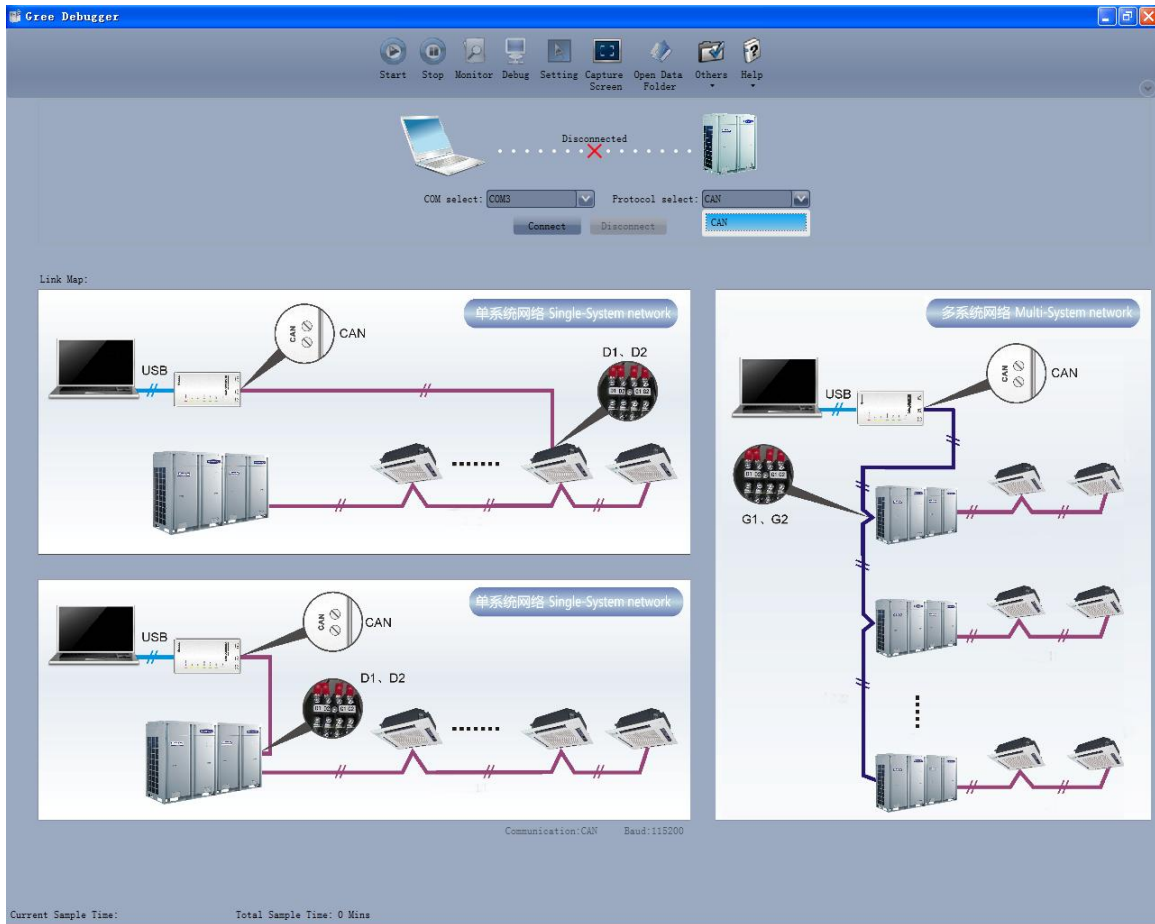

Click "Connect". If units can be in normal communication with the PC, Gree Debugger will switch over to the parameter page. Otherwise, Gree Debugger shows it is being connecting.

# GMV5 DC INVERTER VRF UNITS SERVICE MANUAL

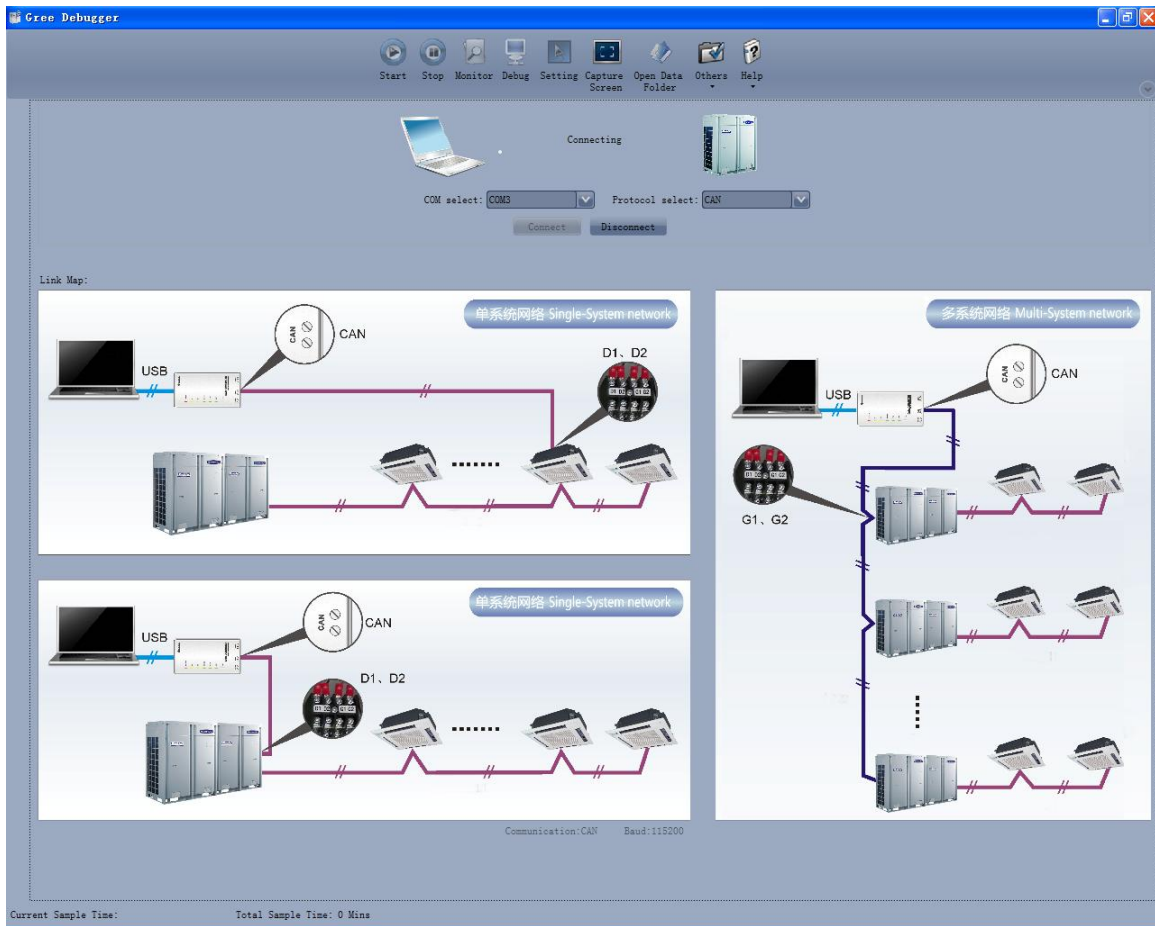

Ip	Machine Type	Master St	Project NO	Rated Capacity	PowerOn St	Mode	Fan Speed	Setted T	In Env T	Inlet T	Outlet
32	Four Way Cassette (T)	Master	1	16	Poweroff	Dry	Fan Stop	69.8	78.8	90	-20

The following figure shows the compositions of the parameter page. You can click and to hide the unit information area and system information area. Within the IDU information area and fault information area, you can drag. Within the outdoor module information area, you can choose to show one module only (by default, two modules are displayed at the same time in the



proportion of 3:1). The menu bar can also be hidden by clicking . In the status bar, current sampling time and total sampling time are shown.

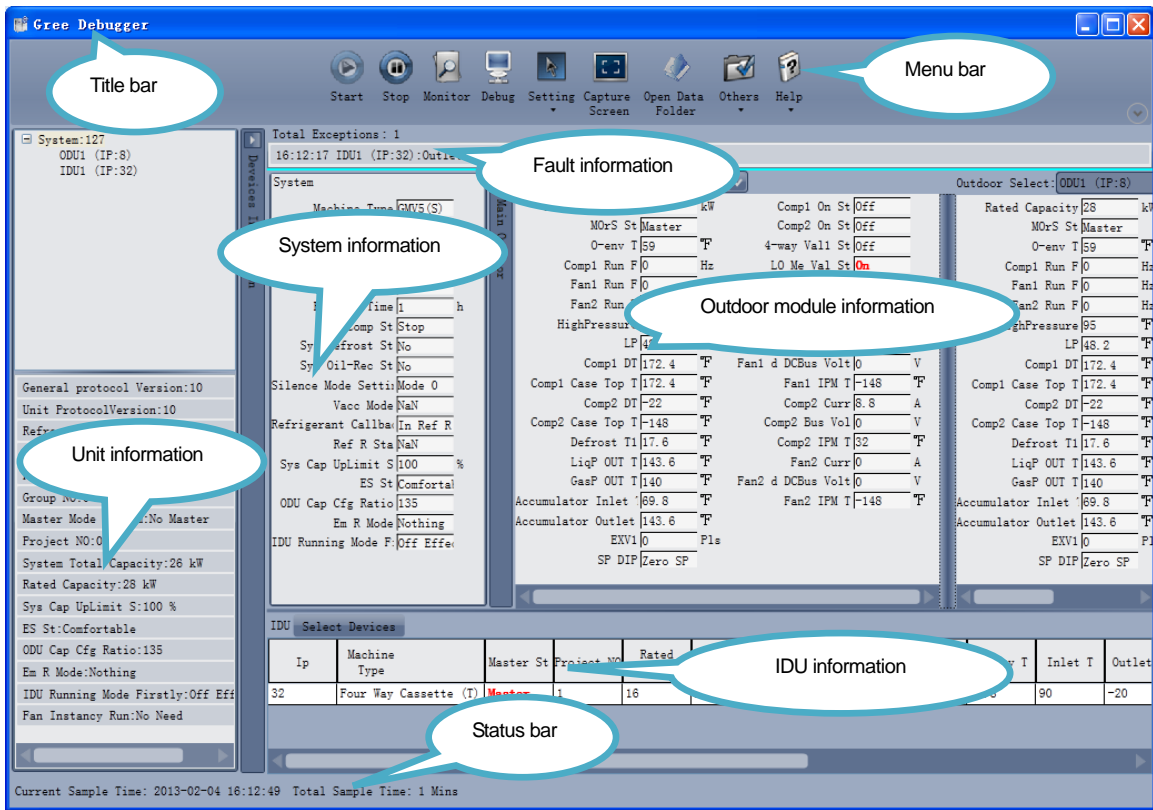



In the unit information area, you can choose to view any unit to be monitored.



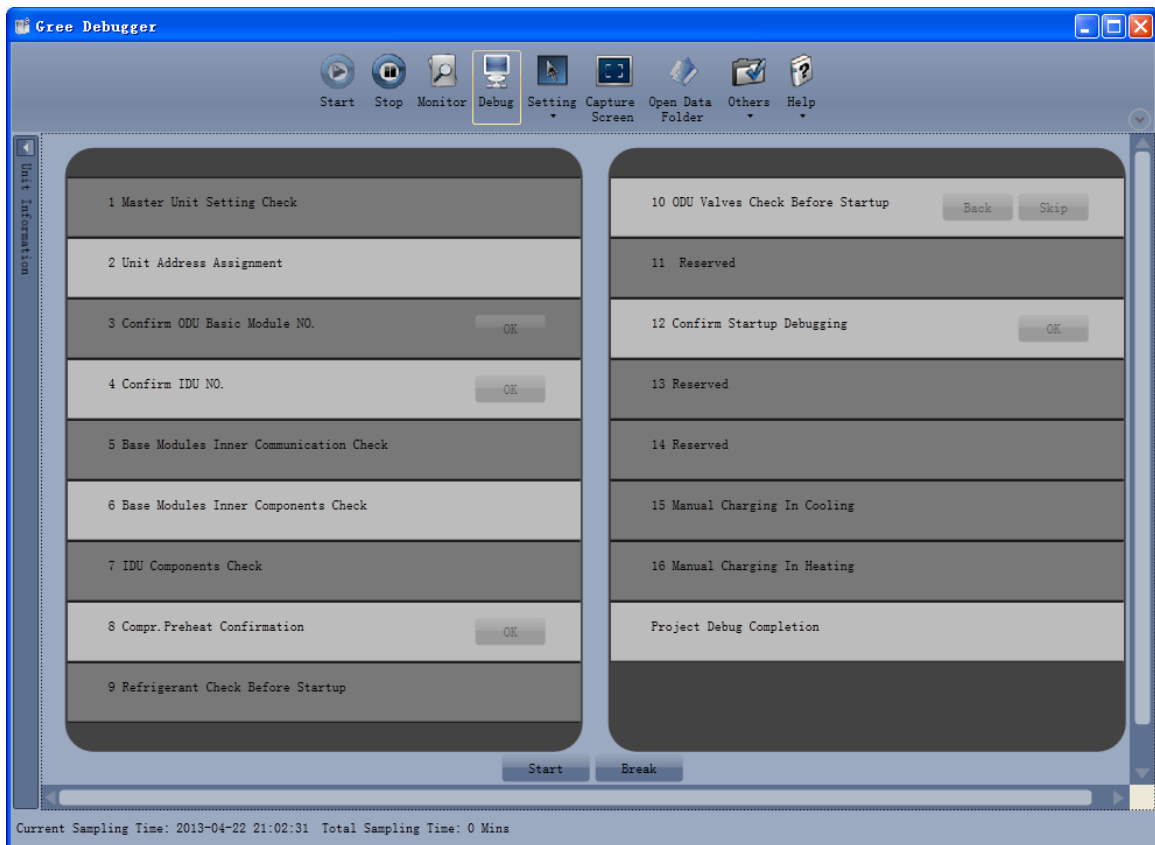

### 1.5.2.2 Engineering Debug

Click “Debug” in the menu bar to switch over to the engineering debug page. Units will automatically execute debug steps one after another based on the order of steps on the page. Note that the debug function can be used for single-system network only.



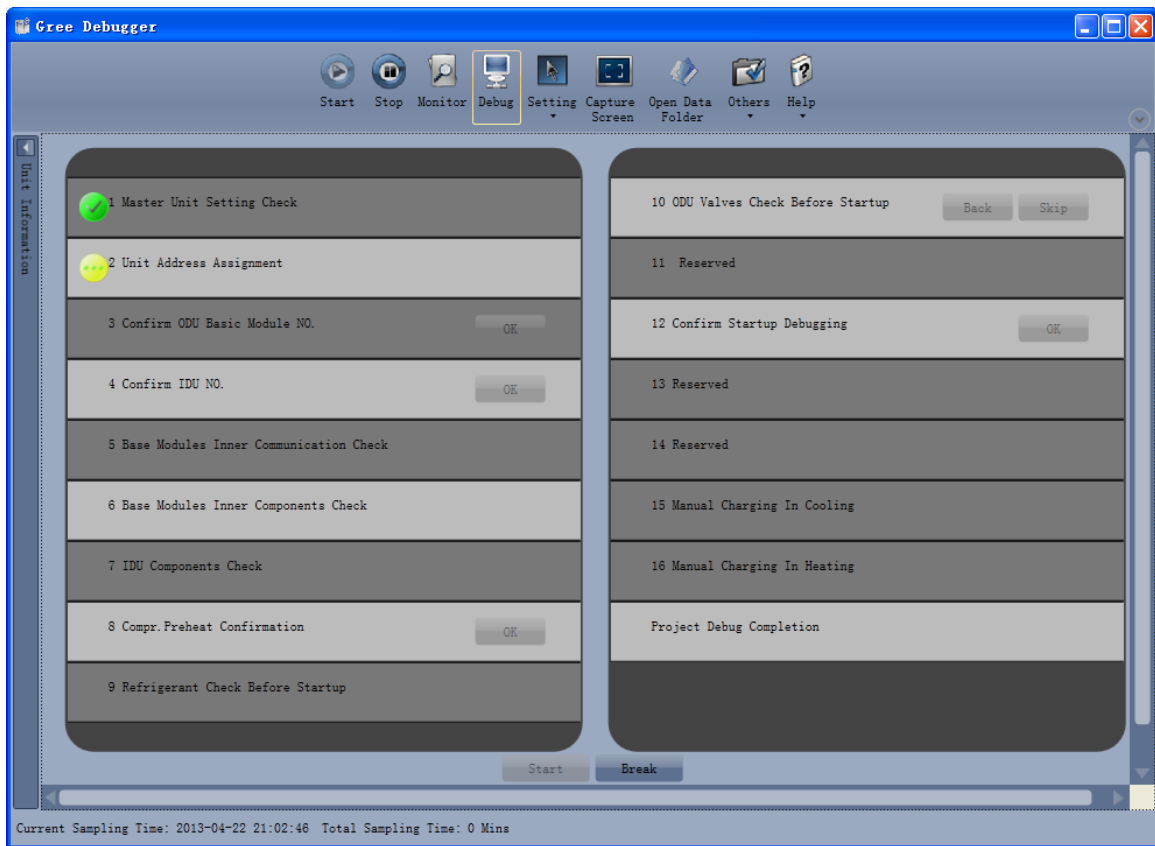

Click “Start” to enable Gree Debugger and units automatically debug.  indicates a currently debugging step and  indicates a successfully debugged step.

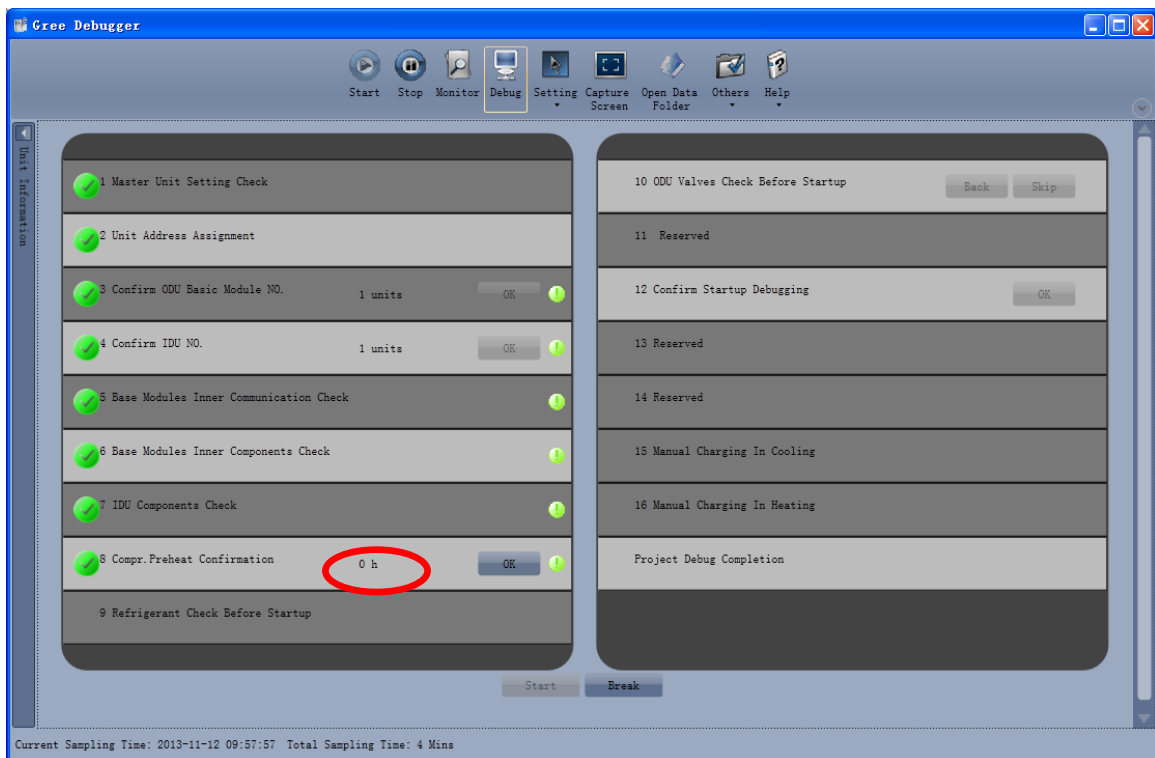
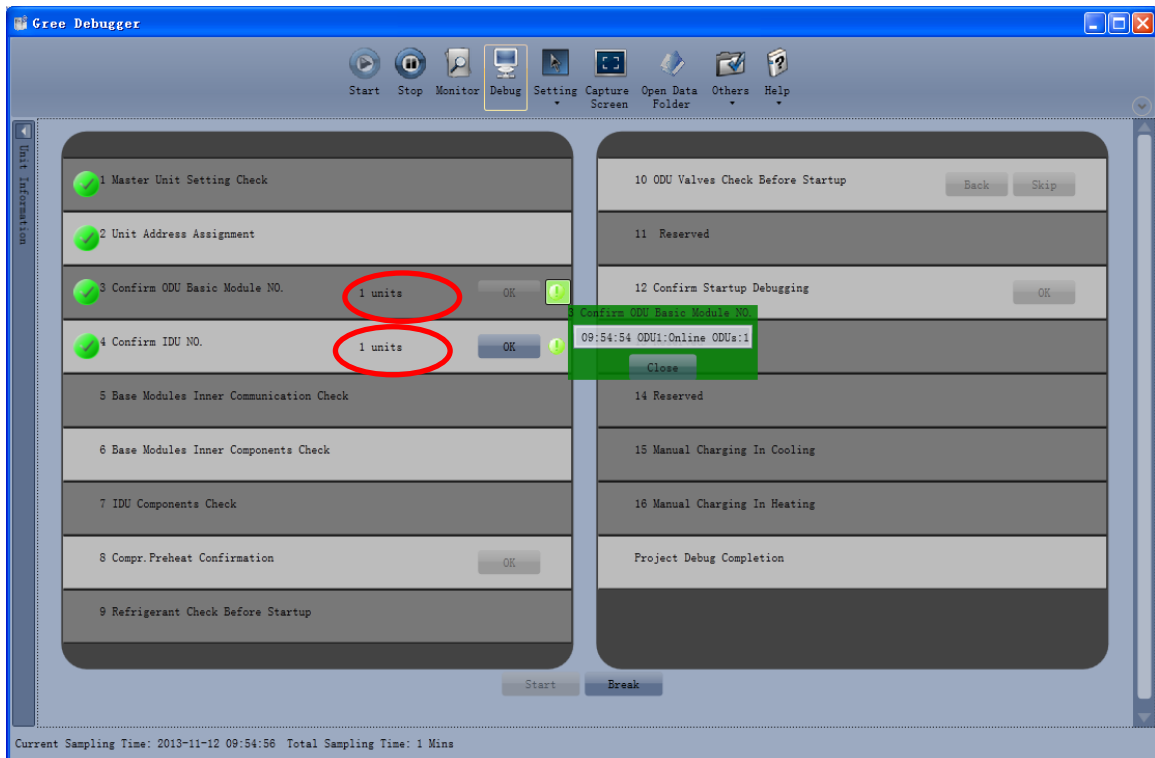

Steps that have the “OK” button available enable users to continue further debug. Click  and corresponding debug information will be shown, enabling you to determine whether to continue

debug. Click “Close” to close the information. For step 3 “Confirm ODU Basic Module NO.” and step 4 “Confirm IDU NO.,” quantity of units debugged will be shown; for step 8 “Compr. Preheat Confirmation”, preheating time will be shown. See the following figures.



The icon  indicates that corresponding step failed and a fault exists. In this case, users need to rectify the fault first. After the issue is addressed, Gree Debugger automatically continues the debug procedure if there is not an “OK” button available; otherwise, users should click “OK” to confirm. Click  and corresponding debug information will be shown, helping you analyze the fault. Click “Close” to close the information.



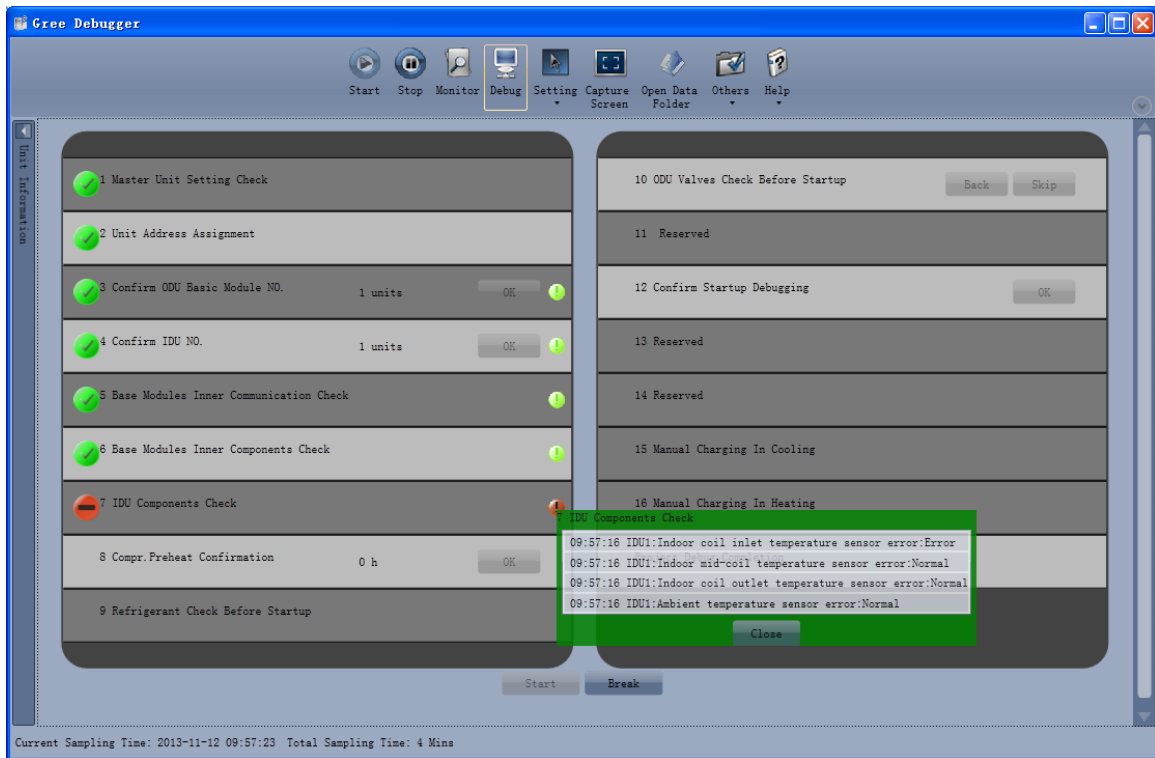

During debugging, if you click “Stop”, the debug is interrupted. Click “Start” to continue debug. When debug goes on to step 10 “ODU Valves Check Before Startup”, “Back” and “Skip” are available. If this step fails, you can go back to step 9. Click “OK” of step 9 to continue step 10. If the failure is U6 fault (valve exception alarm), click “Skip” to skip this step. For other fault causes, this button is greyed out.

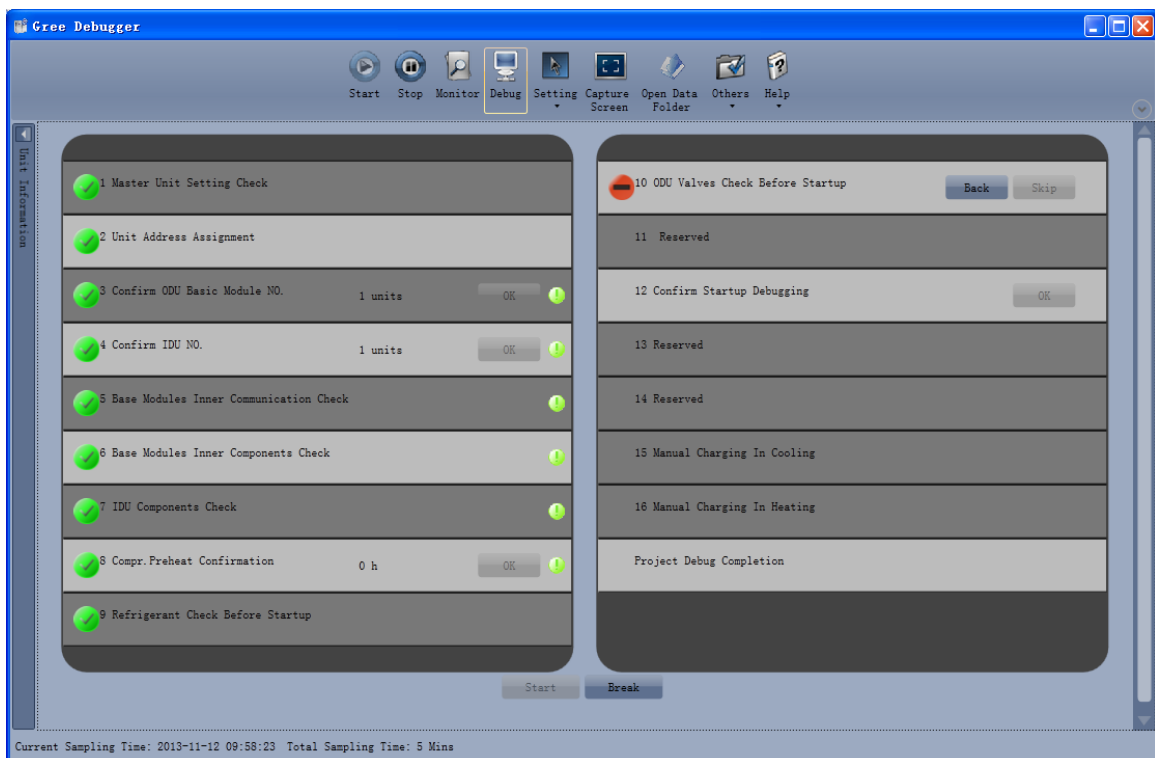

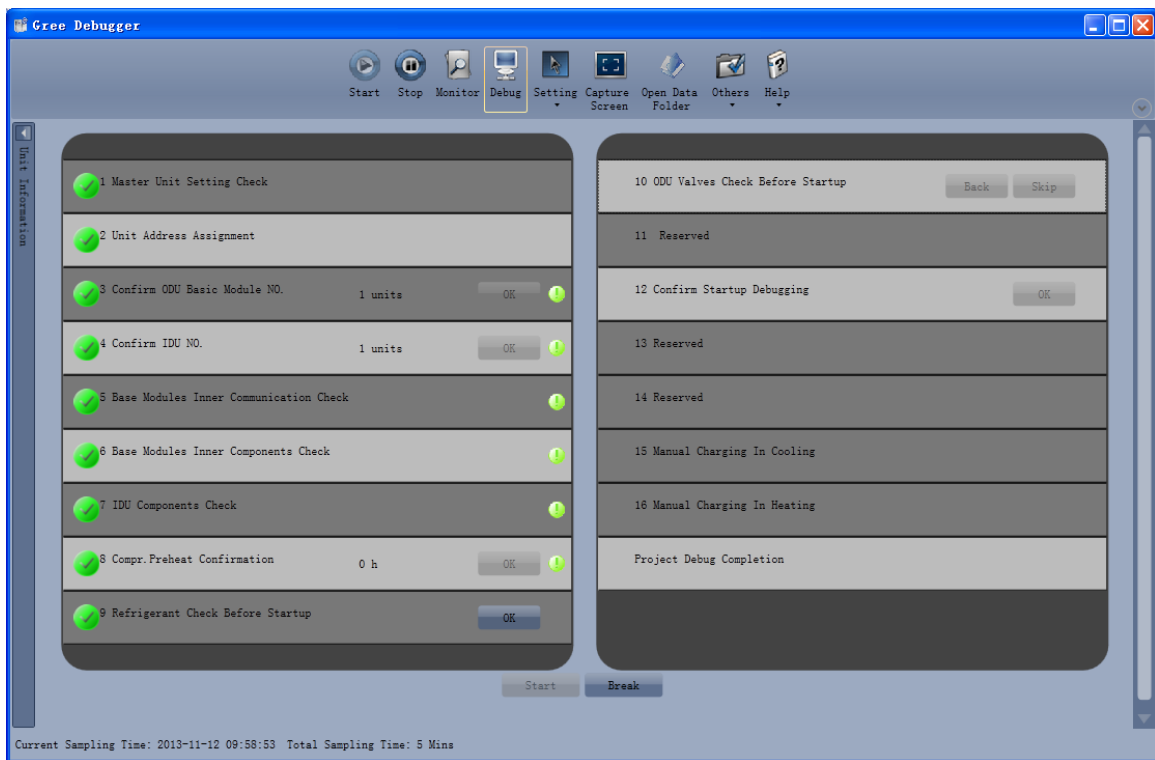

Steps 11, 13, and 14 are reserved. Steps 13 to 16 are concurrent steps. That is, only one of them will be executed at one time.

When “Project Debug Completion” is checked green, the engineering debug is finished.

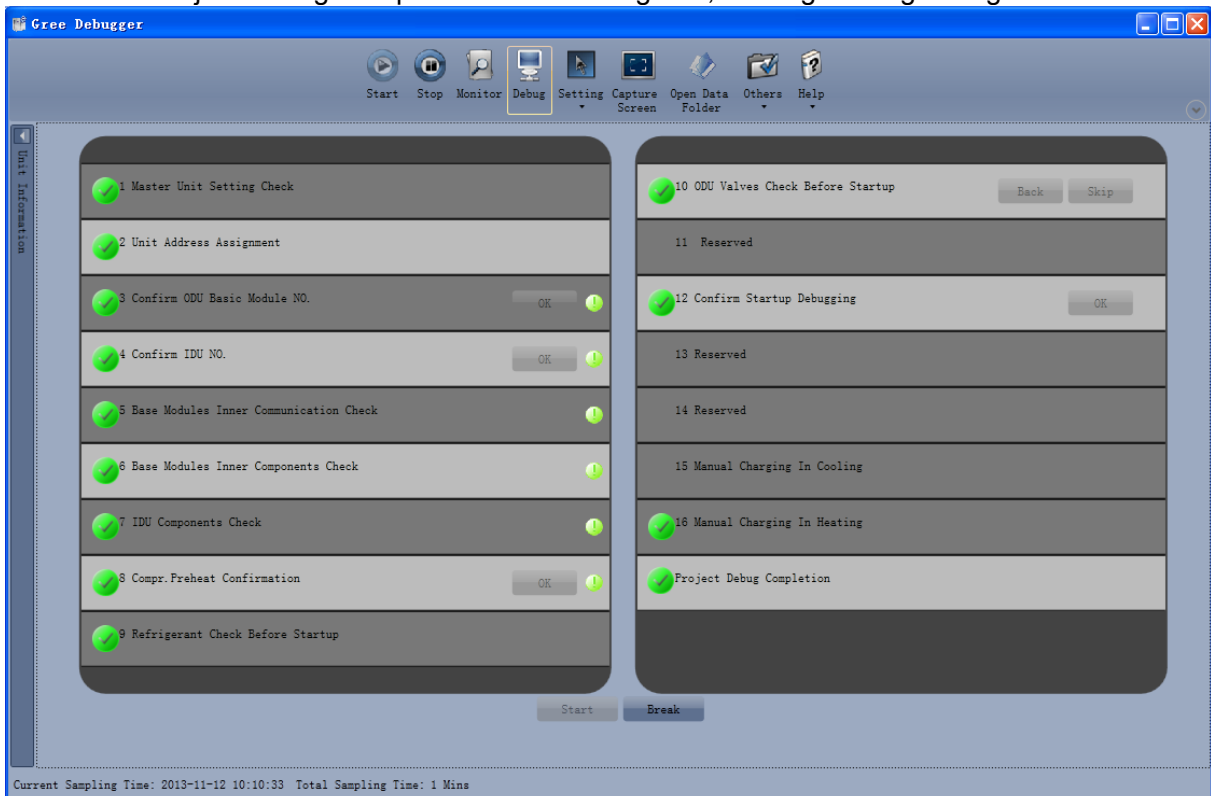

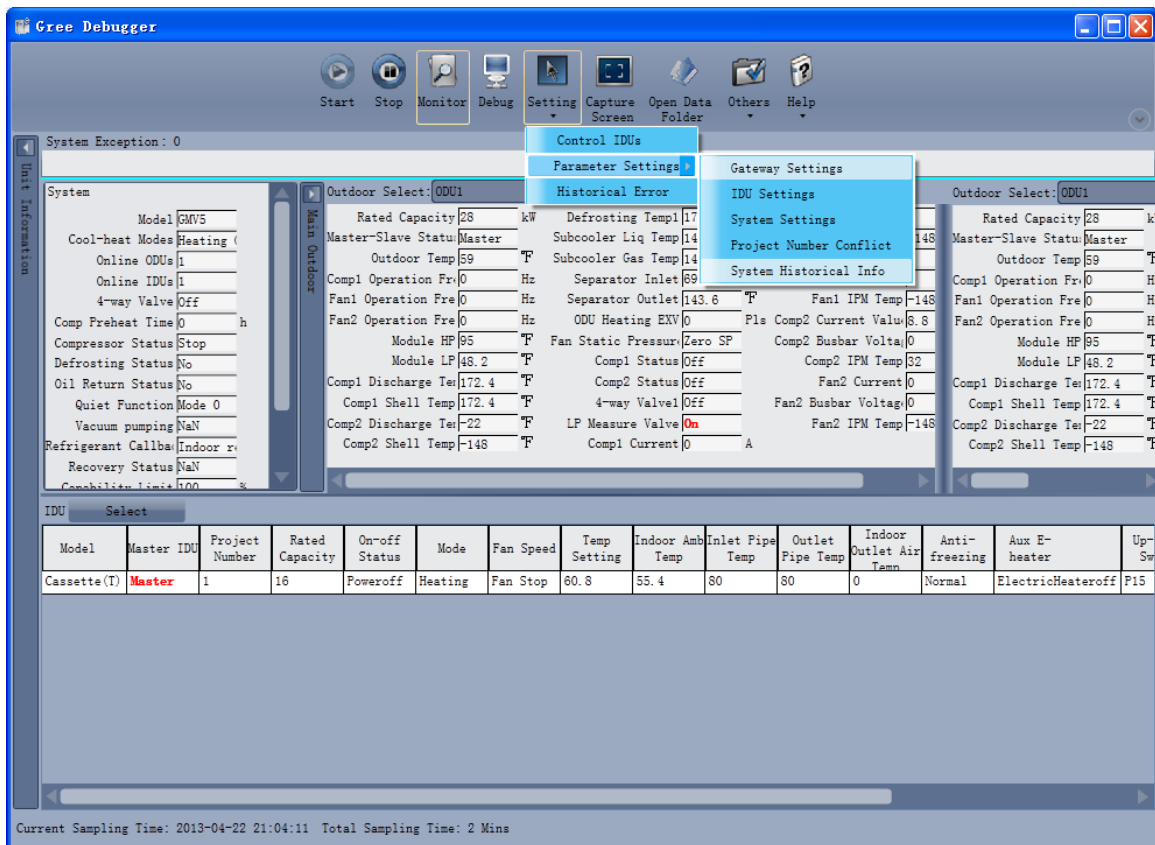

### 1.5.2.3 Controlling Units

In the menu bar, choose “Setting” -> “Parameter Settings”. Shortcut menus “Gateway Settings”, “IDU Settings”, “System Settings”, “Project Number Conflict”, and “System Historical Info” are available. Select one of them to set. Note that if project number of an IDU conflicts, other options will be greyed out. In this case, you need to set the “Project Number Conflict” parameter to solve the conflict.

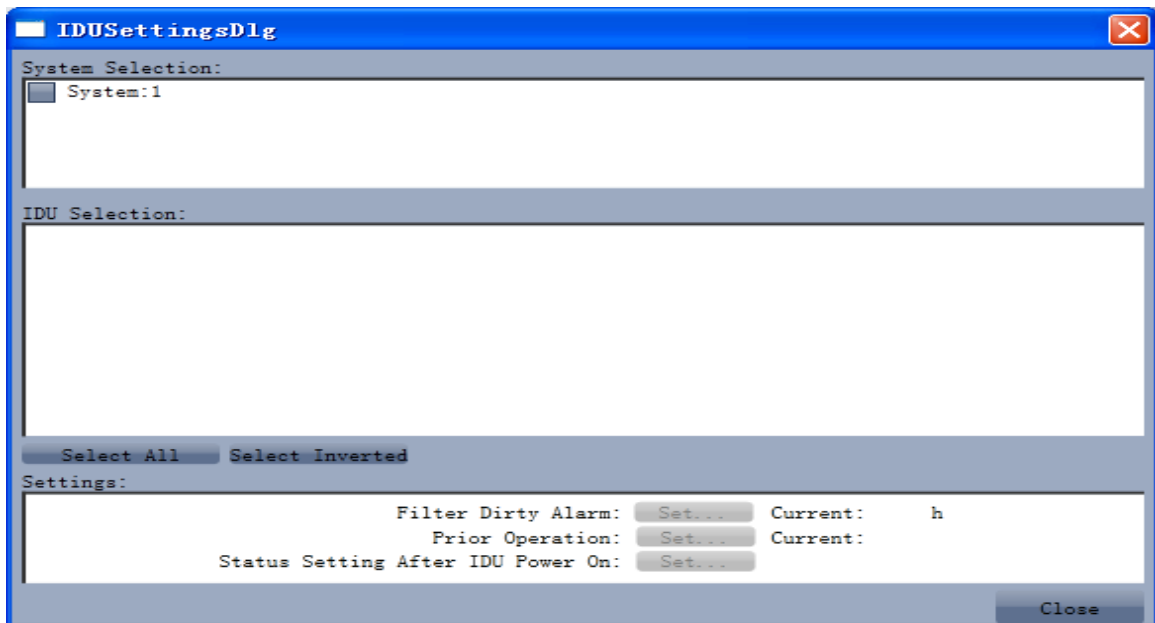

If you select “IDU Settings”, the following dialog box will appear.



Check desired IDUs from the IDU Selection area. You can also click “Select All” or “Select Inverted” to check the IDUs. Parameter information of selected IDUs will be shown in the Settings area. Click “Set...” and click  in the displayed dialog box to select. After you click “Set”, the page will be updated to show the selected value.

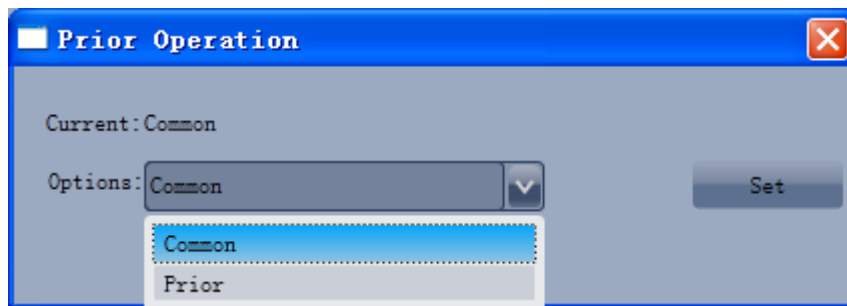
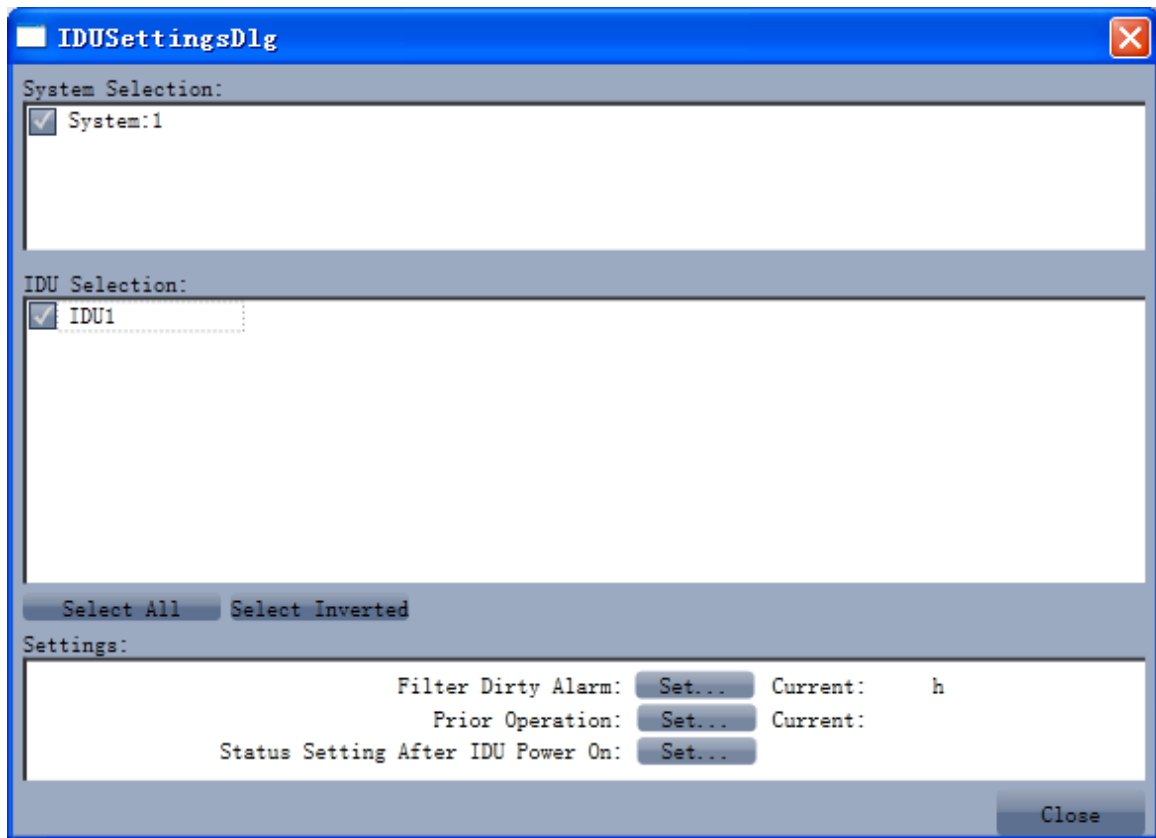

#### 1.5.2.4 Other Functions

##### Capturing screen

To capture a screen, click “Capture Screen” in the menu bar. If you want to open the screen, click “Open”.

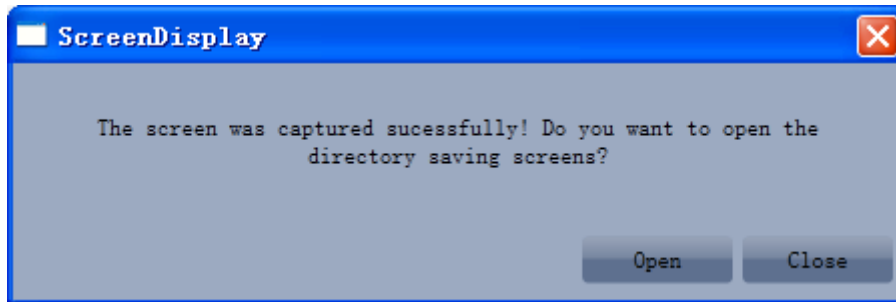
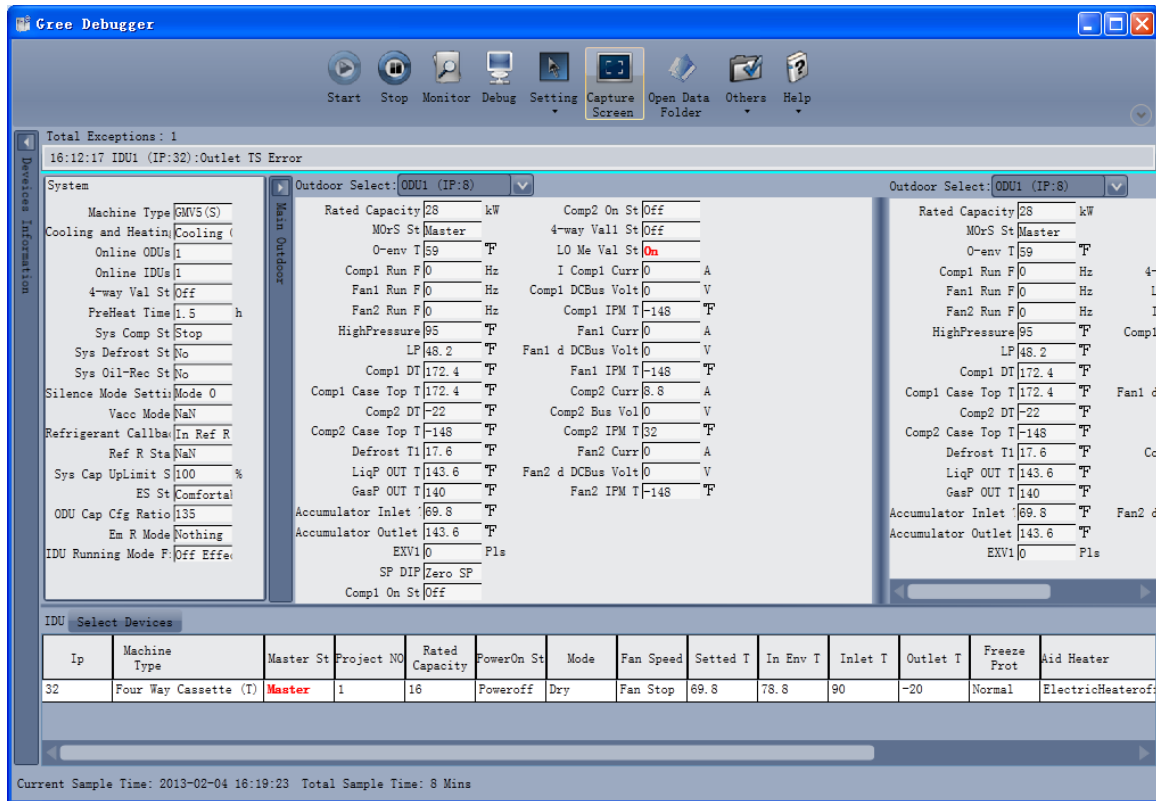

### Searching for database files

To search for database files, click "Open Data Folder" to open the default folder that is saving database files.

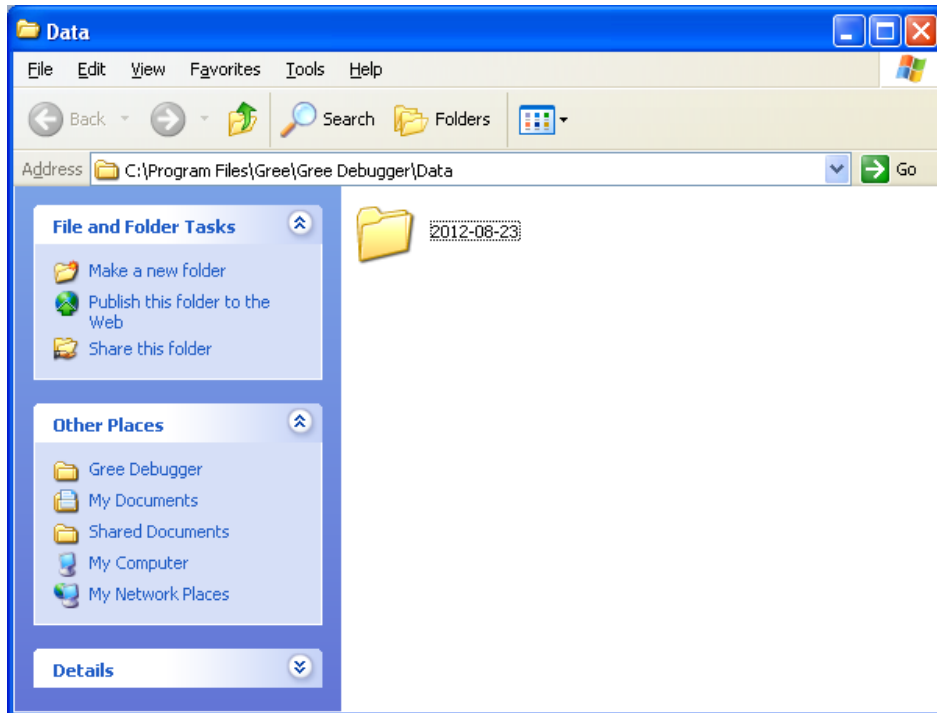
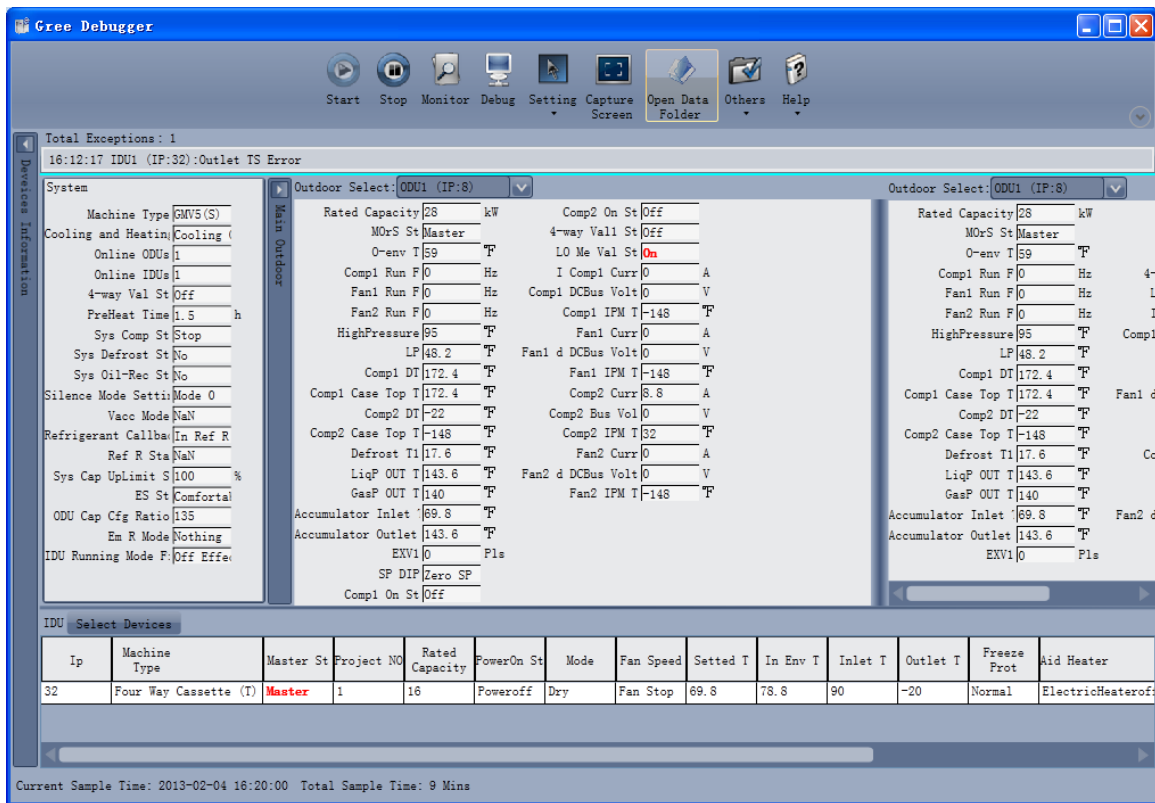

### Changing pressure value

Choose "Others" -> "Display Settings". In the displayed dialog box, you can set "High Low Pressure Value" and "Refrigerant Type". If you set "High Low Pressure Value" to "Temperature", the pressure parameter is changed to temperature; if you set "High Low Pressure Value" to "Pressure", the pressure value is shown. The value of "Refrigerant Type" affects the pressure value.

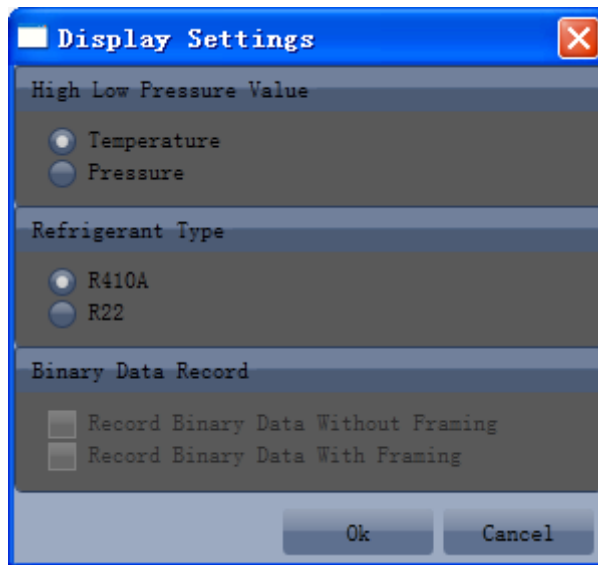
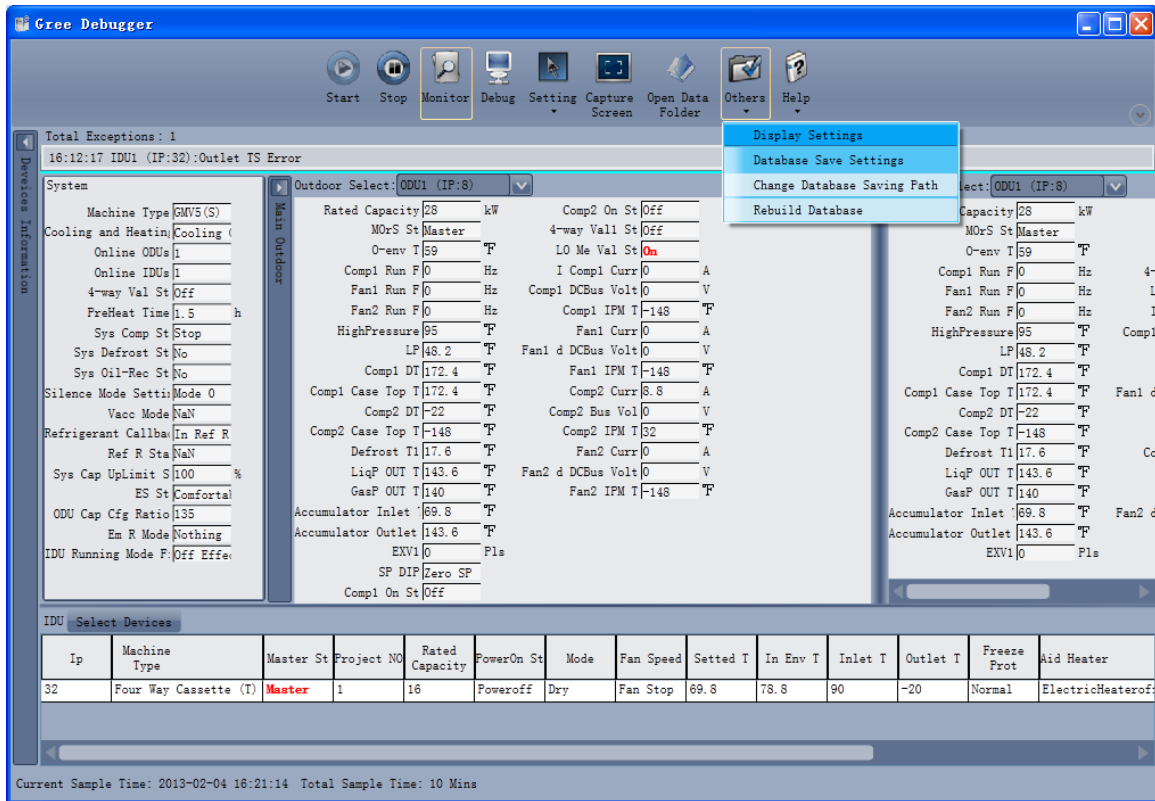

### Saving multi-system data

Choose "Others" -> "Database Save Settings". For a multi-system network, you need to specify a system to save unit data. Since data volume of a multi-system network is large, you can select only a suite of system data to save.

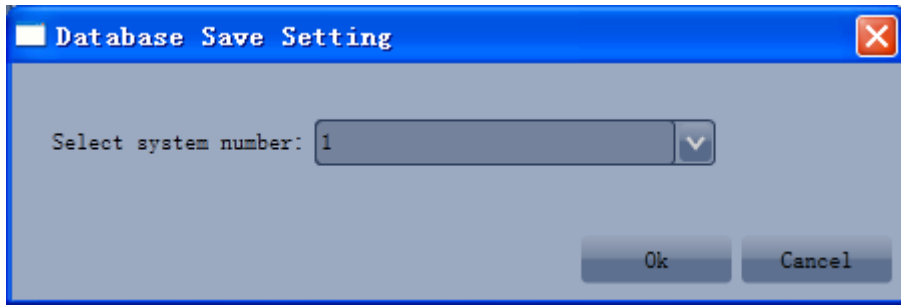
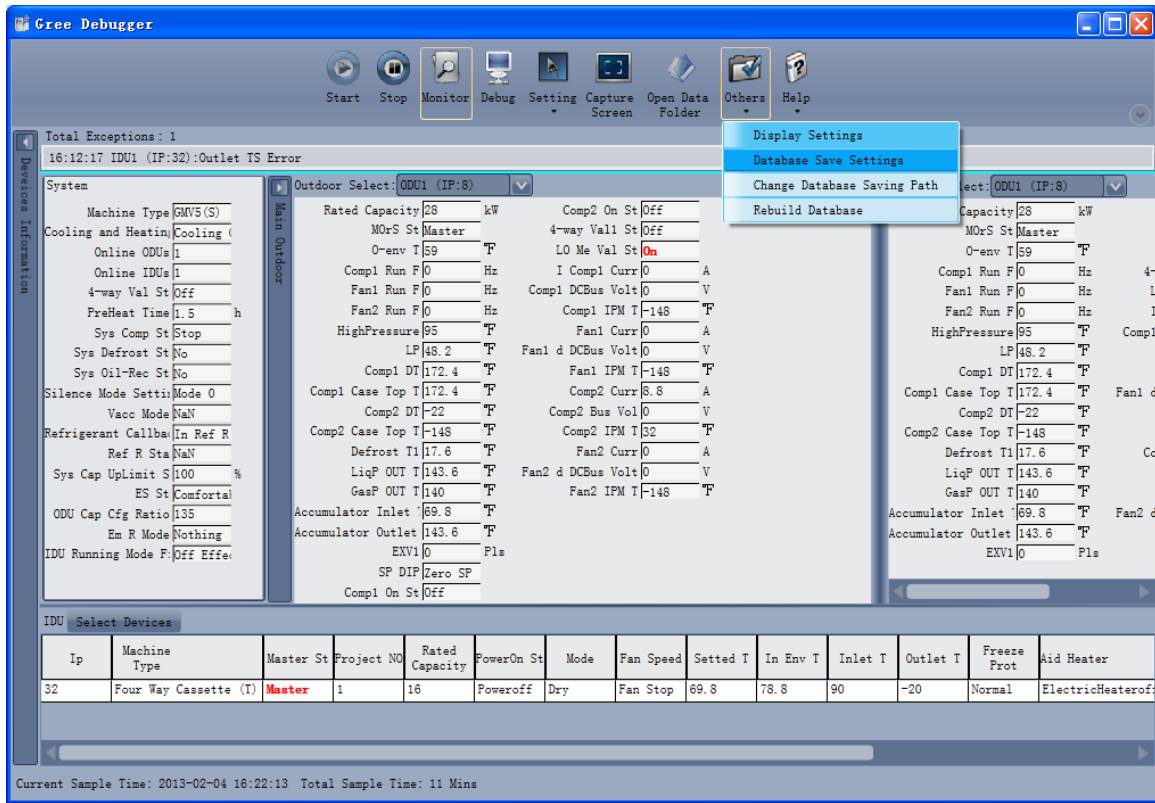

Changing database saving path and rebuilding database

“Change Database Saving Path” and “Rebuild Database” must be configured before Gree Debugger runs. Choose “Others” -> “Change Database Saving Path”. In the displayed dialog box, click “Browse” to select a path. Choose “Others” -> “Rebuild Database” to rebuild database. If Gree Debugger has run, you can stop the software and return to the connection page to operate.



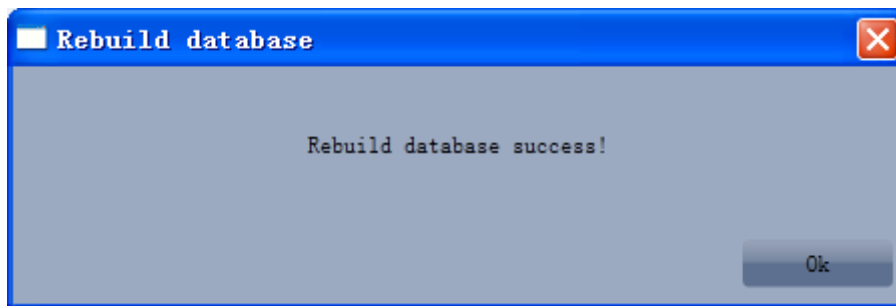
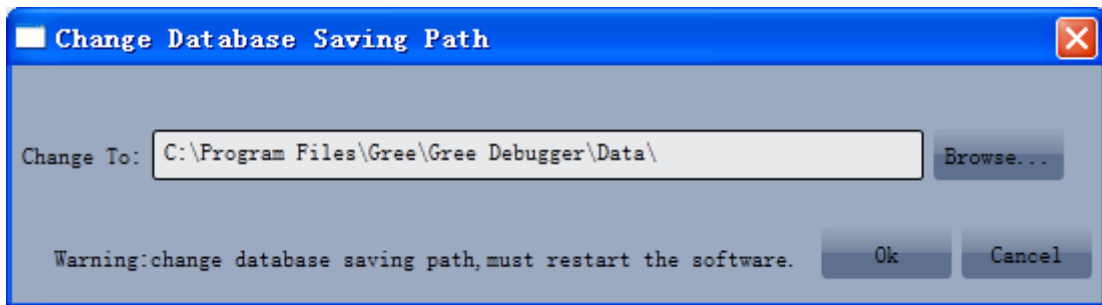
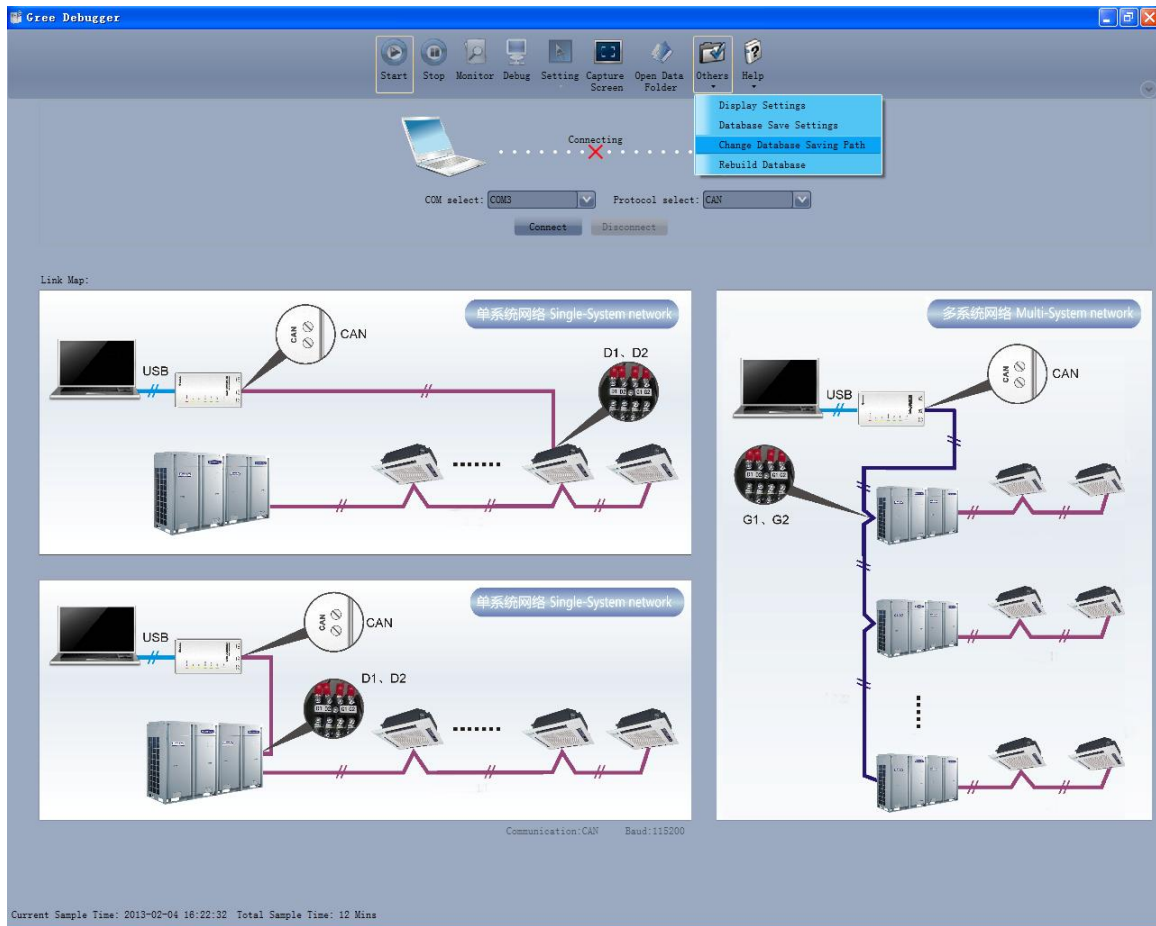

# 1.6 Software Debug

## 1.6.1 Debug Flowchart

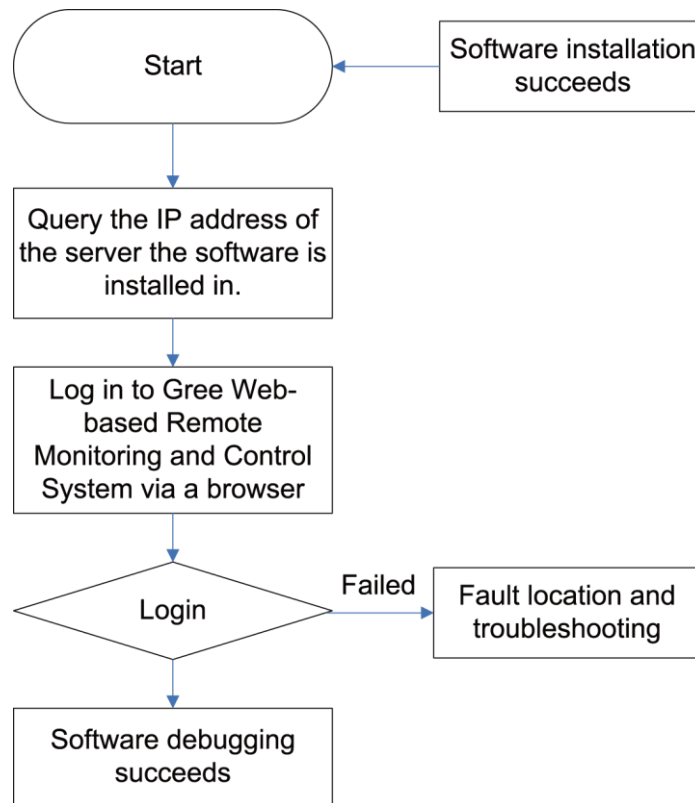

This is a simplified software debug procedure. For details, read the following section.

## 1.6.2 Troubleshooting

### 1.6.2.1 Installation

A fault occurs during Gree Debugger setup.

After you click "Install Gree Debugger" to run, the following prompt is displayed.

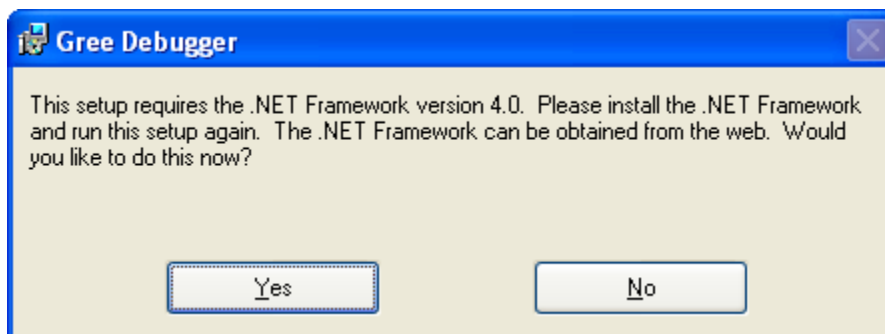

Cause:

The .Net Framework 4.0 is not installed.

Troubleshooting:

Install .Net Framework 4.0 first and then install Gree Debugger.

## 2 Remote Control

Gree CAC Remote Monitoring System is an Internet- or LAN-based remote automation and centralized management system, a smart energy management system, and an all-round solution to air conditioning systems, providing remote control, fault alarm, visualized management and other functions, enabling users to manage air conditioning units in a real time, safe, and effective way.

Gree CAC Remote Monitoring System helps users reduce manpower input and management cost. Through a browser (for example, IE, Firefox, or Chrome), users, wherever they are, can control air conditioners of a building over Internet, including running state query, unit start/stop, and temperature setting.

### Modbus Gateway Remote Monitoring System

## 2.1 Major Functions

- Visualized management
- Centralized control
- Energy management
- Monitoring running state of central air conditioners
- Fault alarm
- Setting running parameters of units

## 2.2 Terms and Definitions

**Server:** A PC for installing Gree CAC Remote Monitoring System and providing remote monitoring and data collection services.

**Client:** A PC for users to access server resources. Through the browser installed on this PC, users can access Gree CAC Remote Monitoring System of the server to perform unit control, data display, and management functions.

## 2.3 Network Topology of Gree CAC Remote Monitoring System

Gree CAC Remote Monitoring System relies on Modbus gateways (model, for example, ME30-24/E4(M)) to communicate with software. The software, gateways, and air conditioning units are combined into a system network. See the following figure:

# GMV5 DC INVERTER VRF UNITS SERVICE MANUAL

Either Gree Web-based Remote Monitoring and Control System or BMS

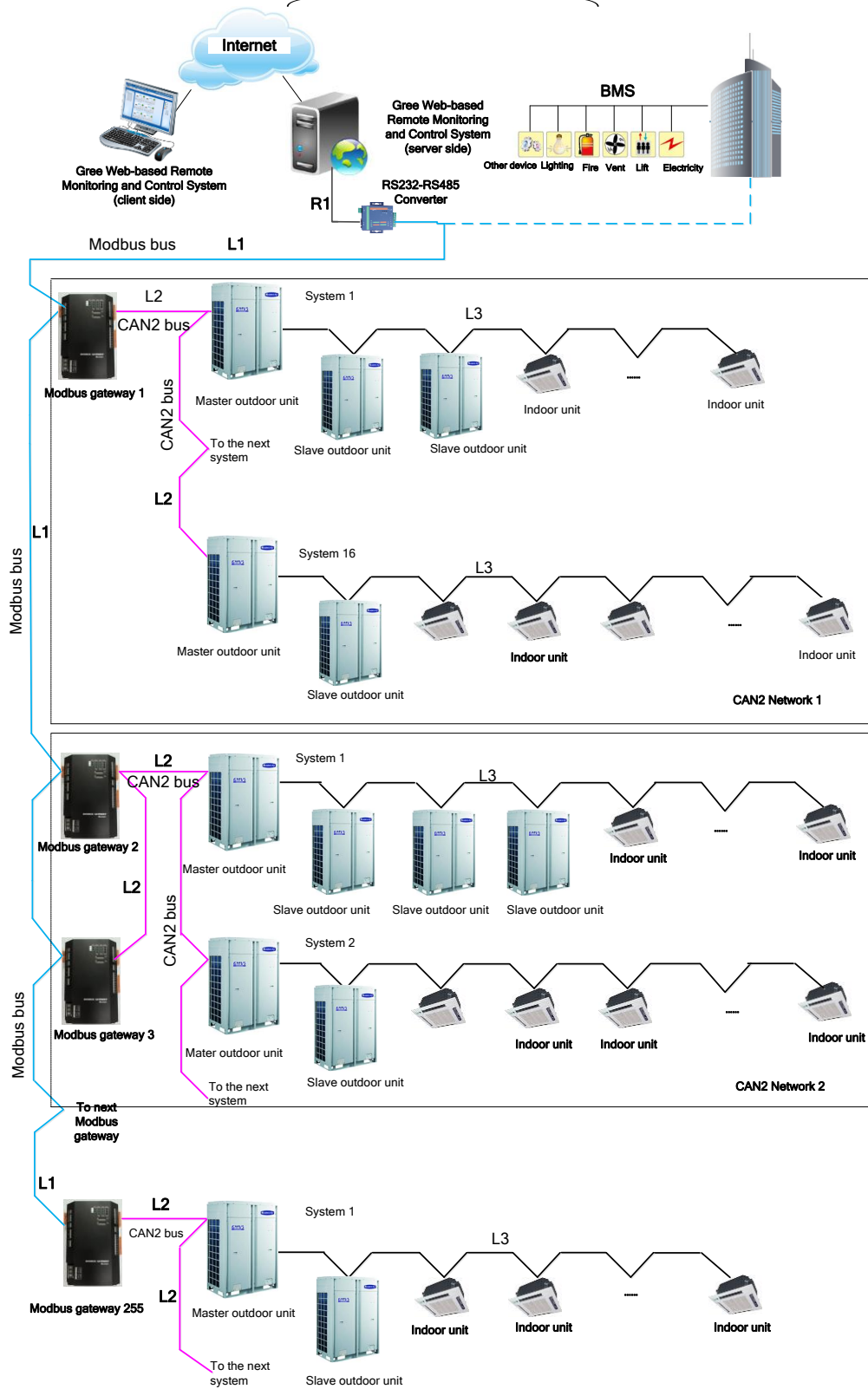

Composition of the System Network

The network is composed of three parts:

Gree CAC Remote Monitoring System of the monitor network, including an RS232-485 Optoelectronic Isolated Converter.

Modbus gateways: They serve to bridge air conditioning unit network with the monitor network and transmit data between the networks. Each Modbus gateway is configured with an address (realized through an 8-bit DIP switch); value range: 1~255. Each gateway address within a system must be unique.

Air conditioning unit network.

Note:

A serial port for the monitor network can be connected to up to 255 Modbus gateways.

Modbus bus: L1 represents the Modbus bus which can support up to 255 Modbus gateways.

CAN2 bus: L2 represents the CAN2 bus which is the link to the Modbus gateway and the master ODU.

CAN2 network: in one CAN2 network, a maximum of 16 air conditioning systems and 255 IDUs are allowed. If exceeded, the CAN2 network should be divided into two.

Air conditioning system: one air conditioning system consists of at most four ODUs (among them one is the master unit) as well as the matched IDUs.

Allowable number accessible to the gateway: one Modbus gateway can support at most 16 air conditioning systems (each system includes at most 4 ODUs) and the total maximum allowable IDUs is 128. If exceeded, another Modbus gateway will be required as shown in CAN2 Network 2.

## 2.4 Hardware

### 2.4.1 List of Parts

Name	Type	BOM	Supply Range	Remark
Modbus gateway suite	Remote monitoring part ME30-24/E4(M)	MC20000060	SC	Interconnect with remote monitoring system: Protocol interface: Modbus RTU Hardware interface: RS485 Baud rate: 9600 Start bit: 1 Data bits: 8 Parity bit: none Stop bit: 1 Main fittings: Modbus gateway, instruction
Optoelectronic isolated repeater	Optoelectronic isolated repeater RS485-W	EN02200010	Optional	For communication bus, set a repeater every 800 m; for Modbus gateways, add a repeater every 30 gateways.
Optoelectronic isolated converter	Optoelectronic isolated converter GD02	EN02200020	Optional	This converter is required only when remote monitoring systems work in RS232 mode.
Control cabinet	/	/	Prepared by users	

### 2.4.2 Modbus Gateway

#### 2.4.2.1 Functions

GREE Modbus gateways for the central air conditioning system are used to bridge the internal network of the air conditioning system (CANbus) and the monitoring network (Modbus). It will provide the Gree web-based remote monitoring and control system/BMS communication interfaces and is enabled to take the real-time monitoring and the long-distance control to the air conditioning system. Also, it will provide the Modbus RTU protocol, five digital inputs and five digital outputs, among which the DI1 is defined for the fire alarm input (when the fire alarm signal is input, the Modbus gateway will stop the air conditioning system immediately).



(1) Interface Drawing

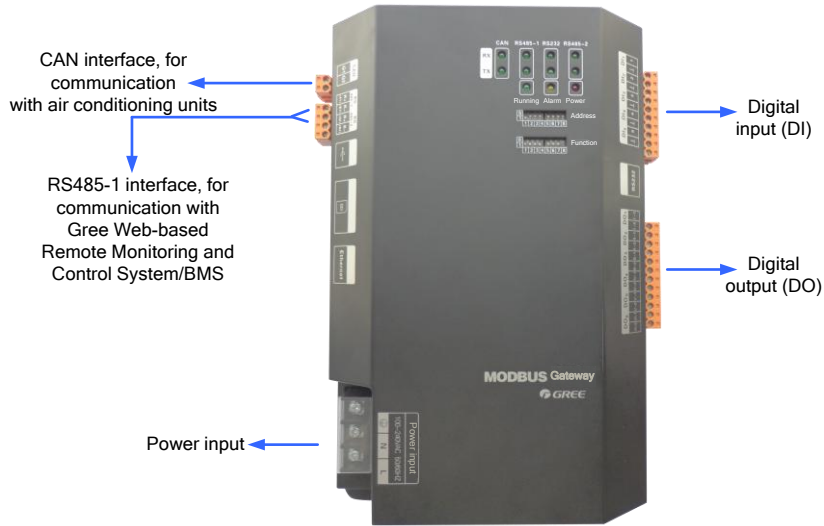

(2) Power Supply Interfaces



CAN Interface: It is connected to the air conditioning system through twisted pairs so as to get through the communication between the Modbus gateway and the air conditioning system.

RS485-1 Interface: It is connected to Gree Web-based Remote Monitoring and Control System/BMS through twisted pairs so as to get through the communication between the Modbus gateway and the Gree Web-based Remote Monitoring and Control System/BMS.

RS485-2 Interface: it is reserved.

2.4.2.2 Hardware Installation

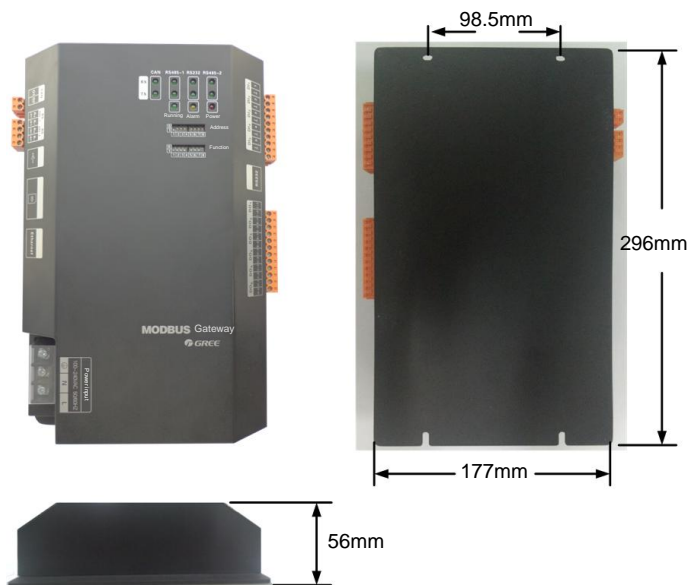

Length x Width x Height: 296 x 177 x 56 (mm)

The Modbus gateway should be located inside the electric cabinet, hung up with the front side facing upwards and fixed with four bolts. See the following figure for the required clearance (only for reference).

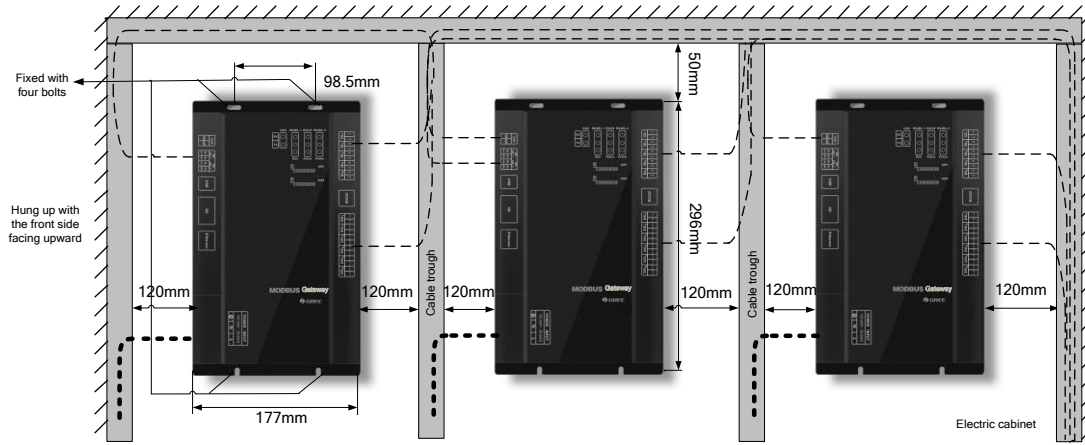

The power input should be 100VAC-240VAC, 50/60Hz.

- ① Do not touch the input port of the power supply when the gateway is energized.
- ② Modbus gateway is recommended to install near air conditioning units so as to shorten their communication distance. The maximum allowable communication distance of them is 500 m. For the communication distance between Modbus gateway and Gree CAC Remote Monitoring System/BMS system, we can use optoelectronic isolated repeaters for expansion.
- ③ The power lines and communication lines of Modbus gateways should be laid separately; otherwise, Modbus gateways may become faulty. In the preceding figure, the thin dotted line indicates communication lines and the thick dotted line indicates strong current lines; they are for reference only.
- ④ Control cabinets should be designed to satisfy Modbus gateways both in number and layout as well as location.
- ⑤ Each Modbus gateway should be supplied with power independently. Therefore, you should install as many 220V AC power sockets as possible in the control cabinet. It is not allowed to connect multiple Modbus gateways to a same power socket.
- ⑥ Make sure to keep at least 15 cm between communication lines and strong current lines. It is forbidden to bind them together. If their distance is less than 15 cm, put them into shield tubes respectively to prevent electromagnetic disturbance.
- ⑦ The control cabinet must be installed indoors. Avoid knock or exposure to sunshine or rain. It should be locked as well to avoid body contact.

#### 2.4.2.3 Communication System Installation

The Modbus gateway works to get through the communication

(1) Between the Modbus gateway and the Gree Web-based Remote Monitoring and Control System/BMS.

(2) Between the Modbus gateway and the air conditioning system.

##### 1. Selection of Communication Lines

(1) Communication lines between the Modbus gateway and the Gree Web-based Remote Monitoring and Control System/BMS

Type	Size	Applicable Standard	Remarks
Category five twisted pairs	24AWG (2×0.6 mm)	TIA/EIA-568-A	An optoelectronic repeater is required when the communication distance is more than 800 m.

(2) Communication lines between the Modbus gateway and the air conditioning system



GMV5 DC INVERTER VRF UNITS SERVICE MANUAL

Type	Length (m)	Wire Gauge (mm <sup>2</sup> )	Applicable Standard	Remarks
Light/Ordinary polyvinyl chloride sheathed cord. (60227 IEC 52 /60227 IEC 53)	$L \leq 500$	$\geq 2 \times 0.75$	IEC 60227-5:2007	<ol style="list-style-type: none"> <li>1. If the wire diameter is enlarged to <math>2 \times 1 \text{ mm}^2</math>, the total communication line length can reach 800 m.</li> <li>2. The cord shall be Circular cord (the cores shall be twisted together).</li> <li>3. If unit is installed in places with intense magnetic field or strong interference, it is necessary to use shielded wire.</li> </ol>

Note: The length of the CAN2 bus connecting the Modbus gateway with master ODUs should not exceed 500 m, as shown in the following figure:

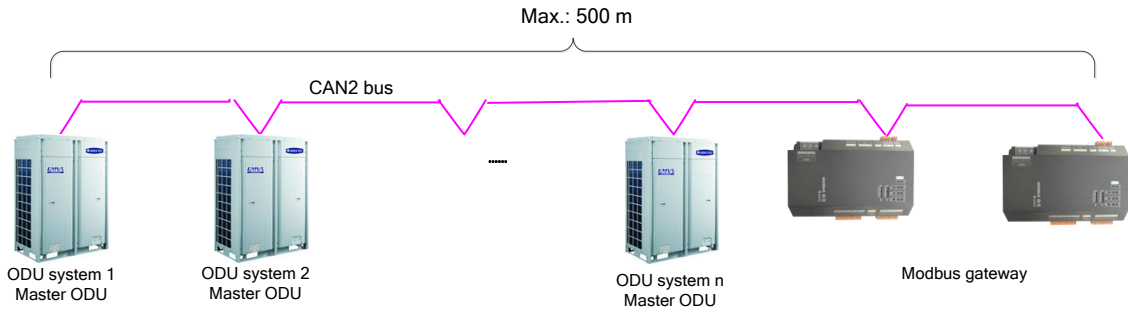

“n” ( $n \leq 16$ ) represents the quantity of the air conditioning systems.

2. Connection of Communication Lines

Note:

Only serial connection is allowed for all communication lines of the Modbus gateway. The star connection is prohibited.

(1) Communication lines between the Modbus gateway and the Gree Web-based remote monitoring and control system/BMS

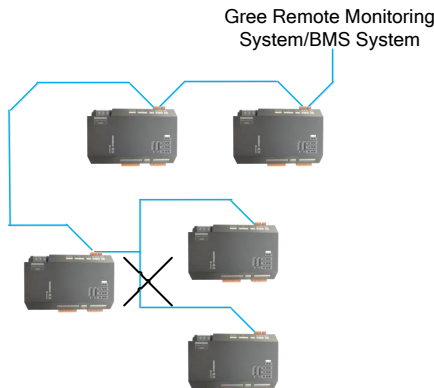
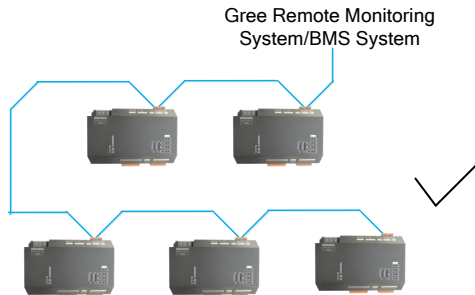

(2) Communication lines between the Modbus gateway and the air conditioning system

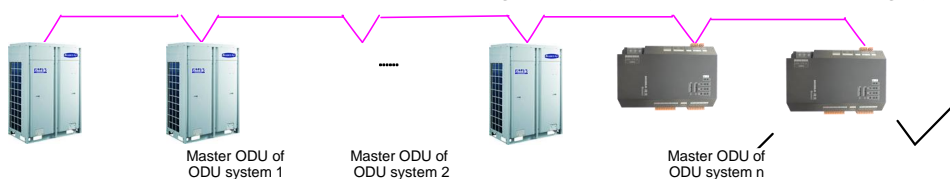

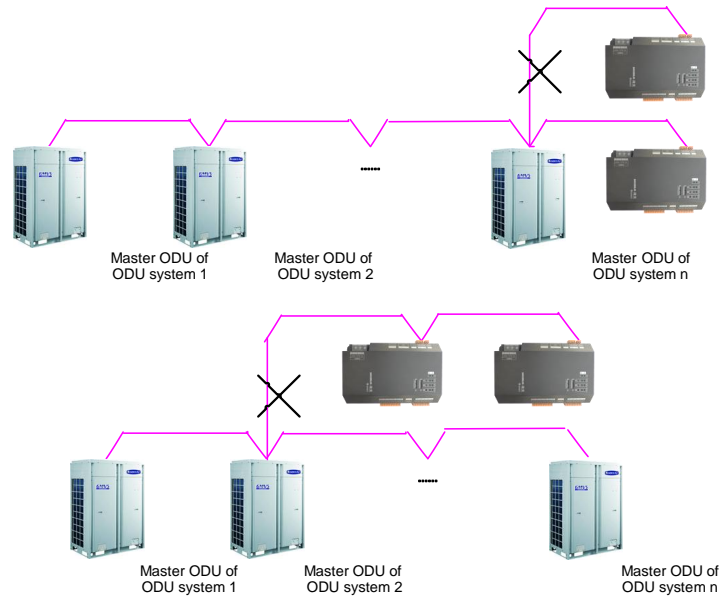

### 3. Connection Steps

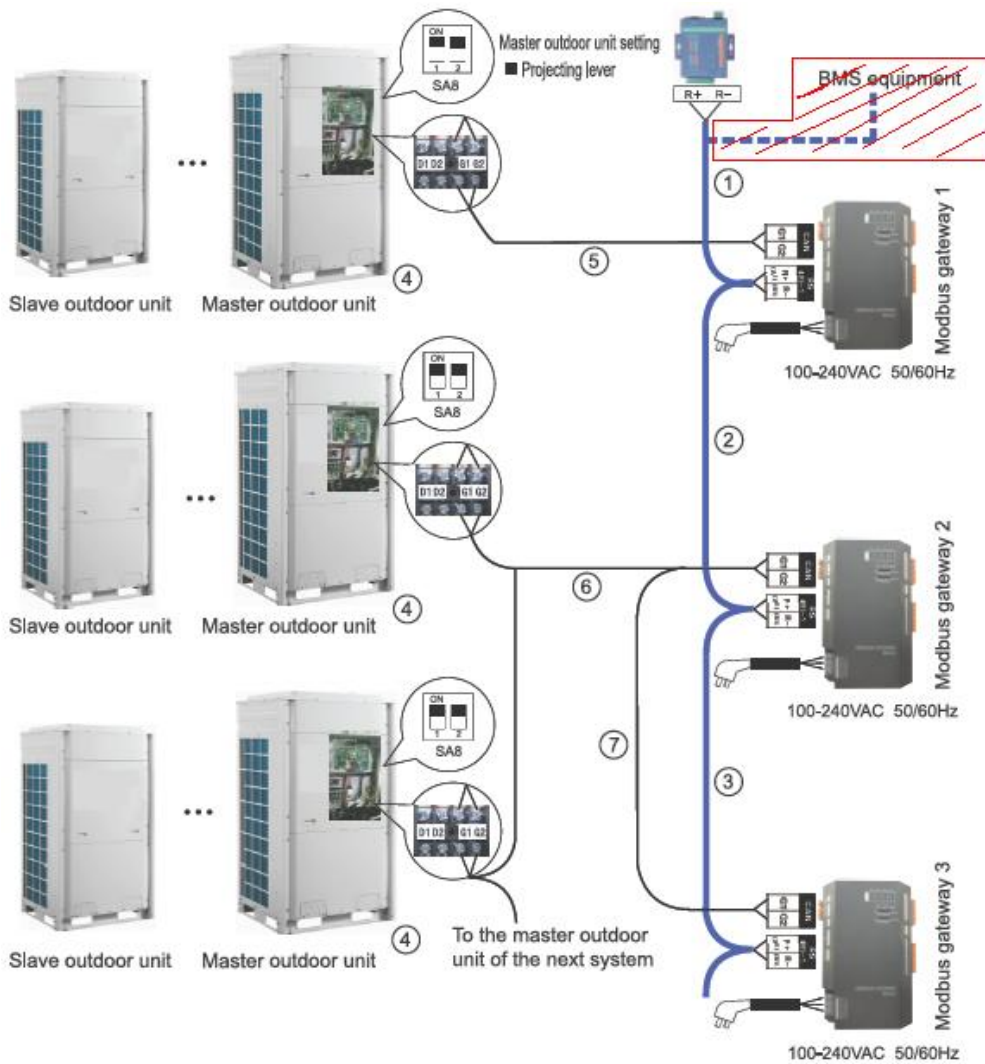

(1) Connection between the Modbus gateway and the Gree web-based remote monitoring and control system

Step 1: confirm the first Modbus gateway (Modbus gateway 1) to be connected to the Gree web-based remote monitoring and control system, and then connect RS485-1 interface R+ and R-

of this Modbus gateway to the optoelectric converter interface R+ and R- or BMS through communication lines. (see ①)

Step 2: connect RS485-1 interface R+ and R- of Modbus gateway 1 to the second Modbus gateway (Modbus gateway 2) RS485-1 interface R+ and R- through communication lines. (see ②)

Step 3: follow the same way as in Step 2 to connect other Modbus gateways in series. (see ③)

(2) Connection between the Modbus gateway and the air conditioning system

Step1: confirm the master units to be connected to each Modbus gateway. Serial connection should be applied as described in Section 5.2.2.(2) Communication lines between the Modbus gateway and the air conditioning system. (see ④)

Step 2: connect the Modbus gateway's CAN interface G1 and G2 to the interface G1 and G2 at the terminal board of the corresponding master unit. (see ⑤)

Step 3: when two Modbus gateways (gateway 2 and gateway 3) are required for one CAN2 network, connect one gateway's (gateway 2) CAN interface G1 and G2 to the interface G1 and G2 at the terminal board of the master unit, and then connect the other gateway's (gateway 3) interface G1 and G2 to the interface G1 and G2 of the former gateway (gateway 2). (see ⑥ and ⑦)

CAN2 network: Please refer to the system network diagram.

2.4.2.4 Hardware Debug

1. DIP Switch

Note:The DIP switches shall be set prior to operation of the gateway.

This Modbus gateway includes two kinds of DIP switches, address DIP switch and function DIP switch.

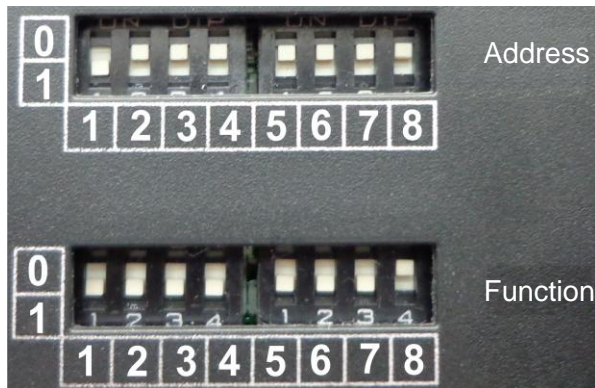

(1) Structural Drawing of the DIP Switches

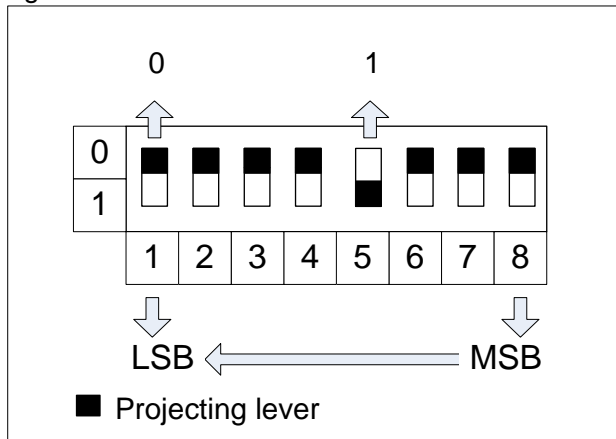

(2) Address DIP Switch—Modbus Gateway Address Setting

The address DIP switch is intended to set the address of the Modbus gateway.

Note:

Before using this gateway, configure an address DIP switch first. This address must be unique in the same bus network; or communication fails.

Value range of Modbus gateway address: 1~255.

Example:

The following figure shows how to set address 11.

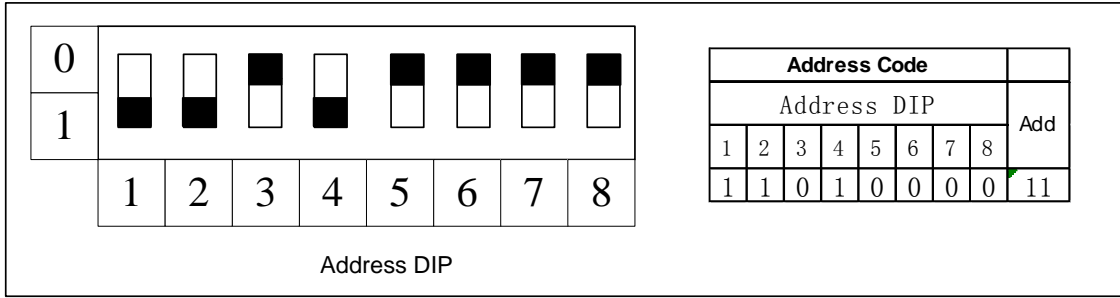

The following figure shows how to set address 43.

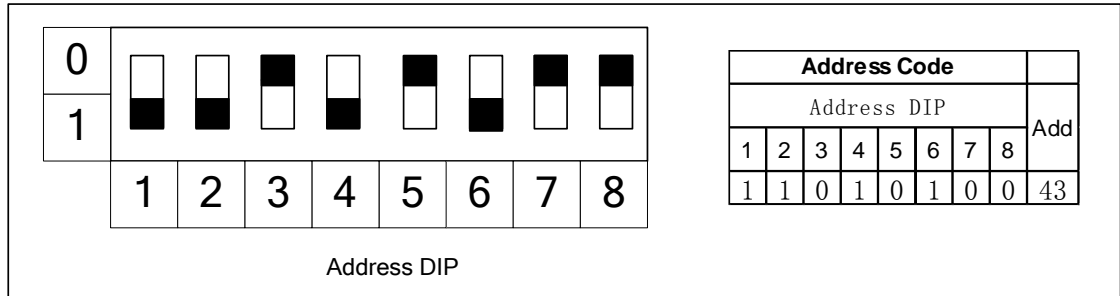

(3) Function DIP Switch-CAN Bus Matched Resistance Setting

Note:

The master ODU of air conditioning system or the gateway located at either end of the CAN2 bus (see the topological drawing) should include a matched resistance; otherwise the normal communication would fail.

The eighth position of this function DIP switch is used to set the matched resistance of the CAN2 bus.

When the Modbus gateway is located at either end of the CAN2 bus, it shall be coupled with a matched resistance and the eighth position should be set to "0".

When the Modbus gateway is located at neither end of the CAN2 bus, no matched resistance is required the eighth position should be set to "1".

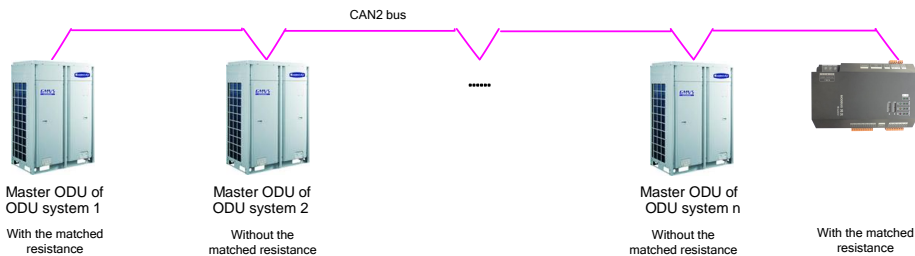

The following figure shows how to set matched resistance:

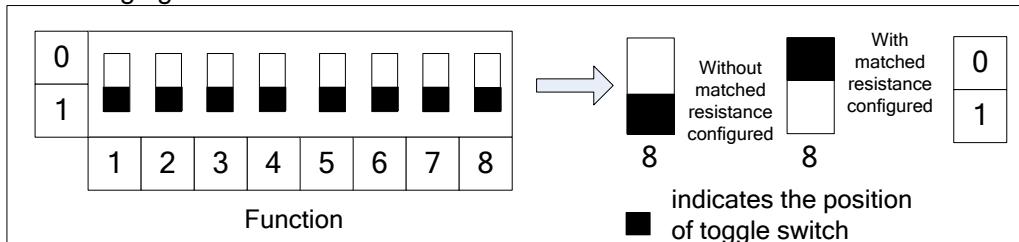

Note: The master ODU at either end of the CAN2 bus must be configured with matched resistance as well. The following figure shows how to set matched resistance for GMV5 DC converter multi-online air conditioning units and specific position:

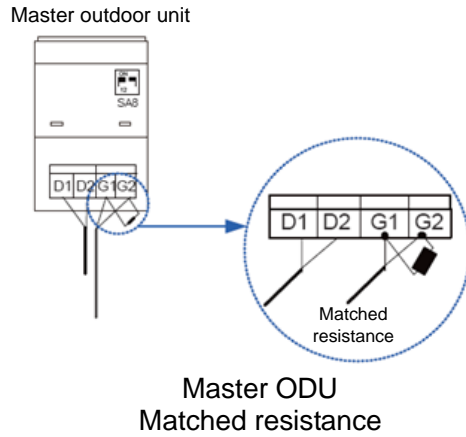

**(4) Function DIP Switch-RS485 Bus Matched Resistance Setting**

The seventh position of this function DIP switch is used to set the matched resistance for the RS485 bus (herein, it is the Modbus bus)

The RS485 bus should be terminated with a matched resistance to avoid signal reflex along the transmission line.

In application of the Modbus gateway, an upper unit as the terminal unit is usually coupled with a RS485 matched resistance, so this gateway is factory defaulted to be without a matched resistance.

When the Modbus gateway is required to be set with a matched resistance, the seventh position of this DIP switch should be set as shown in the figure above to “0” and the gateway should be located at the end of the RS485 bus.

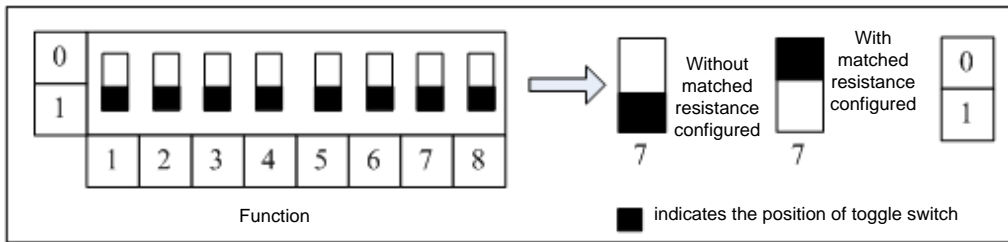

**(5) Function DIP Switch-First IDU No. Setting**

As shown in the topological air conditioning network, each IDU has an identification number.

The sixth position of the function DIP switch is intended to set the first IDU number which is used to define the range of the IDUs under the control of the gateway.

The number of IDUs ranges from 1 to 255.

When the first IDU number is set to “1”, it indicates the range of the IDUs under the control of the gateway is 1 through 128.

When the first IDU number is set to “129”, it indicates the range of the IDUs under the control of the gateway is 129 through 255.

When the IDU number is beyond the range defined by the gateway, it should be modified.

The following figure shows how to set the No. of the first IDU under the control of the gateway:

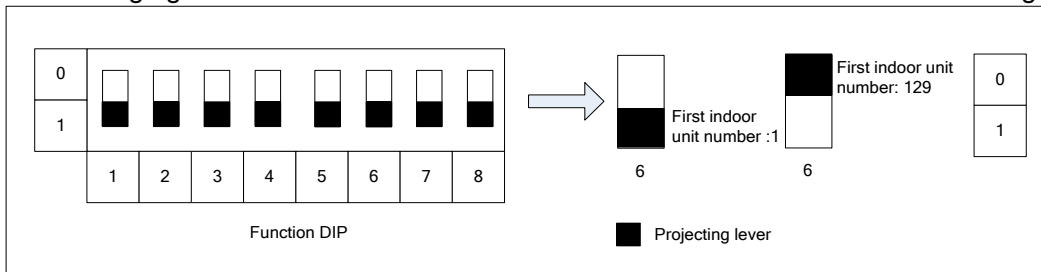

**2. Indicating LED**



CAN	RX	It flashes when the gateway receives data from the target equipment (like, the air conditioning system).
	TX	It flashes when data is communicated to the target equipment (like, the air conditioning system).
RS485-1	RX	It flashes when the gateway receives data from the monitoring PC or BMS.
	TX	It flashes when data is communicated to the monitoring PC or BMS.
RS232	RX	It is reserved.
	TX	It is reserved.
RS485-2	RX	It is reserved.
	TX	It is reserved.
POWER		It lights on when the Modbus gateway is powered normally.
RUN		It flashes when the Modbus gateway is in normal operation.
ALARM		It is reserved.

### 3. Digital Inputs and Outputs



This gateway supports five DIs (digital inputs) and five DOs (digital outputs). There is another reserved digital output DO 6.

DI1...DI5

Digital inputs: binary (0/1) digital signals, applicable to passive inputs.

DI 1: it is defined for the fire alarm input. When K1 is short circuited, DI 1 will input the binary signal "1", which indicates that the Modbus gateway will stop the whole air conditioning system at once. When K1 is opened, DI 1 will input the binary signal "0", which indicates the whole system will resume the normal operation.

DI2...DI5: they will be defined by the user.

E.g.: when K5 is closed, DI 5 will input the binary signal "1" and input the binary signal "0" when it is opened.

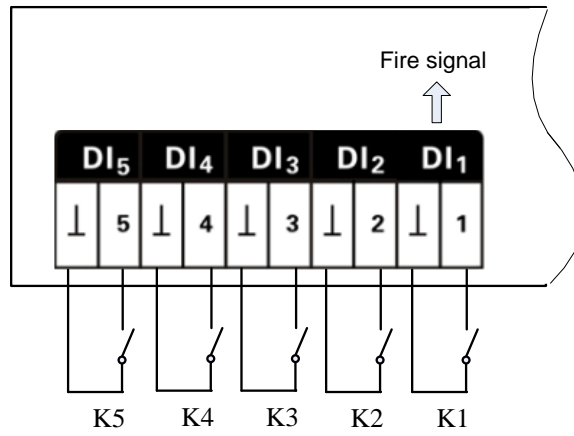

**DO1...DO5**

Digital outputs: relay outputs, normally open contacts.

Maximum allowable power: 250VAC,3A; 30VDC,3A

E.g.: when DO 5 is input the binary signal "1", its two contacts will be closed; when DO 5 is input the binary signal "0", its two contacts will be opened.

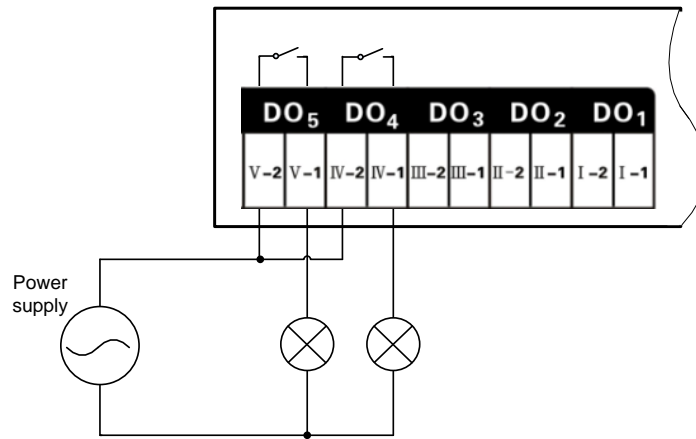

2.4.2.5 Communication Debug



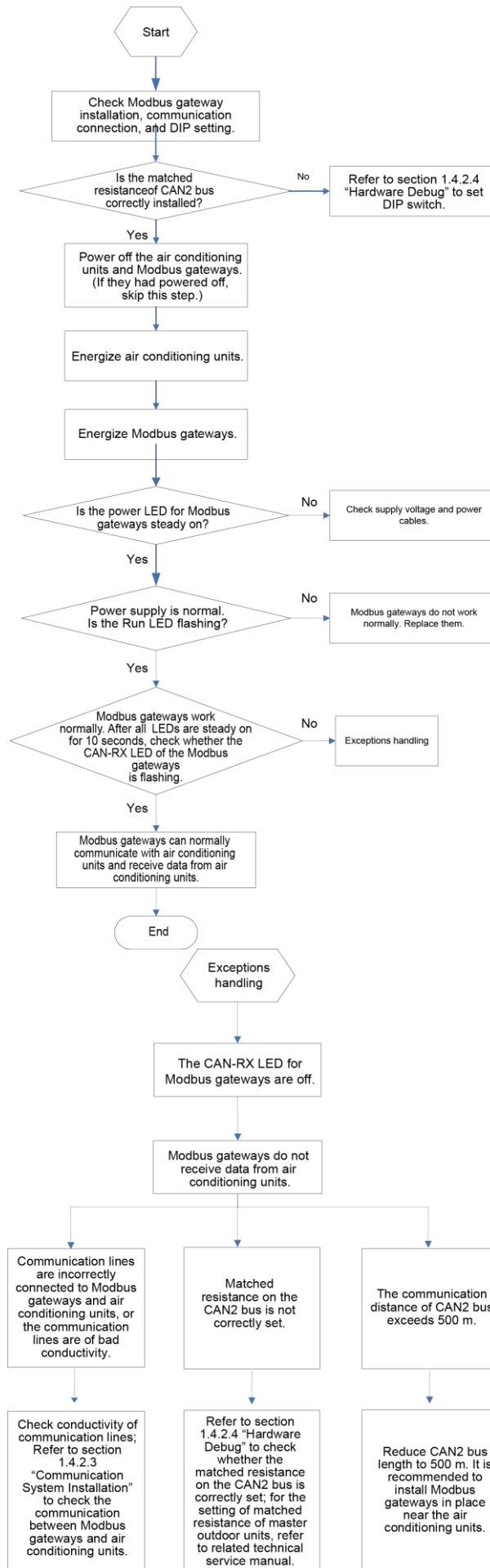



**2.4.3 Introduction of Optoelectronic Isolated Converter**

2.4.3.1 Function Introduction

The optoelectronic isolated converter is designed to convert the RS232 signal from the computer serial port into RS485 signal. It is only used when the user's BMS system uses RS232 communication mode.

2.4.3.2 Appearance

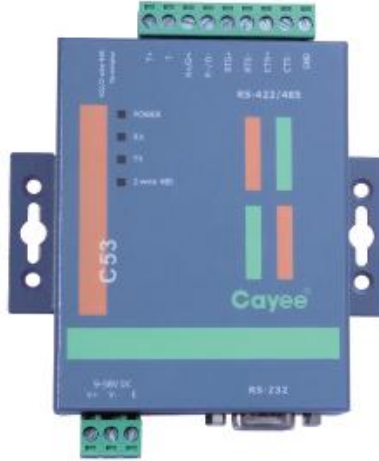

Note: Actual product prevails. The picture is for reference only.

2.4.3.3 Interfaces and LEDs

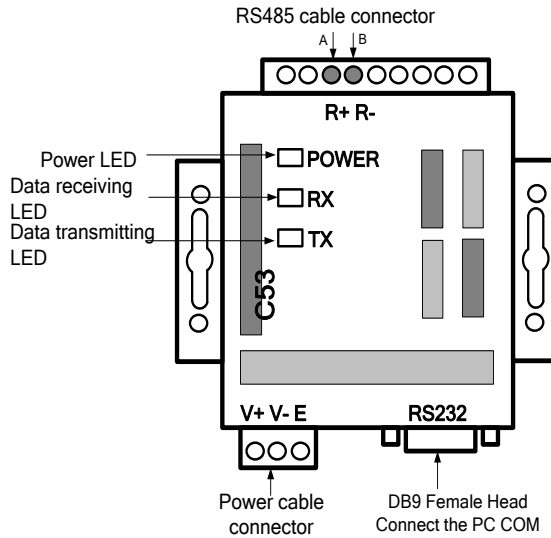

SN	Interface Name	Description	Remark
1	Power interface	<b>Input AC220V~50HZ; Output 12~30V DC 800mA</b>	Accompanied power supply of the converter
2	Communication interface	Line A of RS485 connected to R+ on 485 terminal, and Line B connected to R-. RS232 port connected to RS232 on computer	See related instructions
3	Power indicator	Normally bright when it is energizing.	See related instructions
4	Communication indicator	RX/TX indicator blinks during normal communication.	See related instructions

2.4.3.4 Dimensions

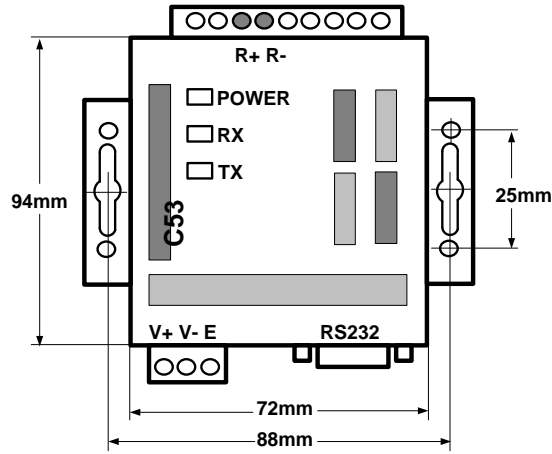

2.4.3.5 Cautions on Installation

- ① It must be installed indoors. Avoid knock or exposure to sunshine or rain. It is suggested to place it in the monitoring room together with the computer.
- ② The manufacturer's original equipment must be used. Never use any other model or substitute product.
- ③ Independent power supply is required. Make sure to install adequate 220V AC socket for power supply.

2.4.4 Introduction of Optoelectronic Isolated Repeater

2.4.4.1. Function Introduction

Function of optoelectronic isolated repeater

- 1) To ensure the signal completeness and prevent the signal from attenuation under long distance communication when the distance of the whole communication line exceeds 800m.
- 2) The general optoelectronic isolated repeater at present can support 32 nodes and ensure completeness of their communication signals. When the communication nodes in the network exceed 32, the communication signal will become incomplete. To ensure reliable transmission and completeness of the signals, we require that repeater must be used when the number of nodes in the network exceeds 30.

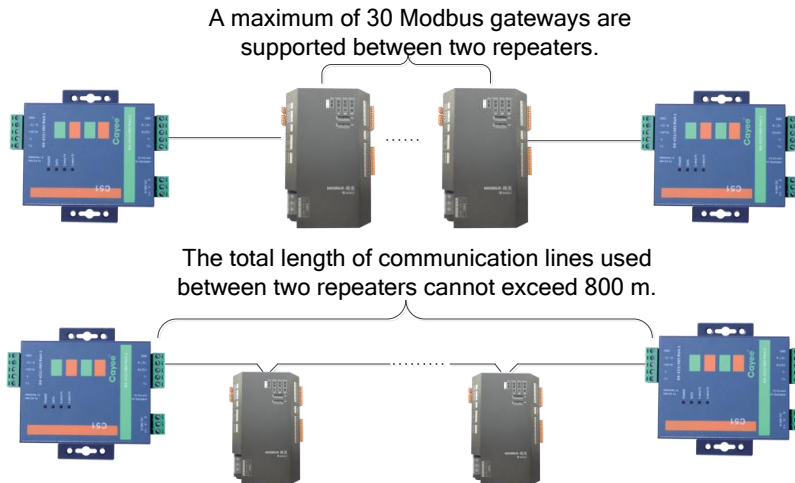

2.4.4.2 Appearance



Note: Actual product prevails. The picture is for reference only.  
 2.4.4.3 Interfaces and LEDs

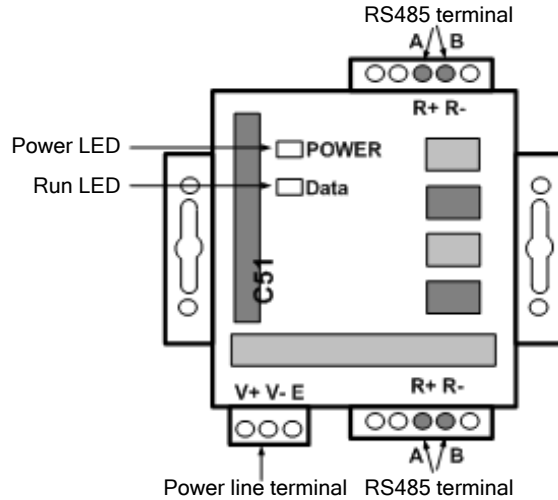

SN	Interface Name	Description	Remark
1	Power interface	Input AC220V~50HZ; Output 12~30V DC 800mA	Accompanied power supply of the repeater
2	Communication interface	Line A of RS485 connected to R+ on 485 terminal, and Line B connected to R-.	See related instructions
3	Power indicator	Normally bright when it is energizing	See related instructions
4	Communication indicator	Data indicator blinks during normal communication.	See related instructions

2.4.4.4 Dimensions

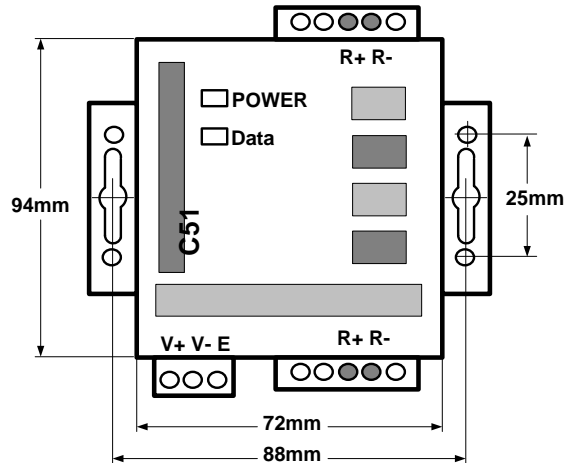

2.4.4.5 Cautions on Installation

- ① It must be installed indoors. Avoid knock or exposure to sunshine or rain. It is suggested to place in the control room together with the computer.
- ② The manufacturer's original equipment must be used. Never use any other model or substitute product.
- ③ Independent power supply is required. Make sure to install adequate 220V AC socket for power supply.

## 2.5 Software

### 2.5.1 List of Parts

Parts of Gree CAC Remote Monitoring System

Part	Quantity	Supply Range	Purpose
Disk	1	SC	Used for installing Gree CAC Remote Monitoring System on a PC
Installation guide	1	SC	Providing instruction on the installation of Gree CAC Remote Monitoring System

### 2.5.2 Preliminary Check

Check whether the Modbus gateway has been successfully debugged. If not, refer to the Technical Service Manual of Modbus Gateway to debug the gateway.

Check whether the server has serial ports. If not, replace the server with one that has serial ports.

Check whether the server is configured with driver that can read disks. If not, replace the server with one that has driver.

Check whether the server satisfies the following software configuration requirements.

Software configuration of Gree CAC Remote Monitoring System

Part Name	Min. Configuration	Recommended Configuration
Internet Information Service (IIS) manager	6.0 or later versions	6.0
MSMQ	/	/
Memory	1 GB or larger	2 GB or larger
Hardware	10 GB available	10 GB available
CPU	Main frequency: 2 GHz or higher	2 GHz or higher
OS	Windows Server 2003 SP2 or later versions, Windows 7	Windows Server 2003 SP

Note:

Gree CAC Remote Monitoring System supports Windows Server 2003 SP2 or later versions and Windows 7. Windows Server 2003 SP2 is recommended because the server can better provide users with services in Windows Server 2003 SP2 system.

### 2.5.3. Software Setup

The software needs support of some Windows components in order to run; therefore, you should install these components first before setup. The following installation flowchart shows you the basic installation procedure. If some of the components have been available on your PC, you can skip corresponding steps.

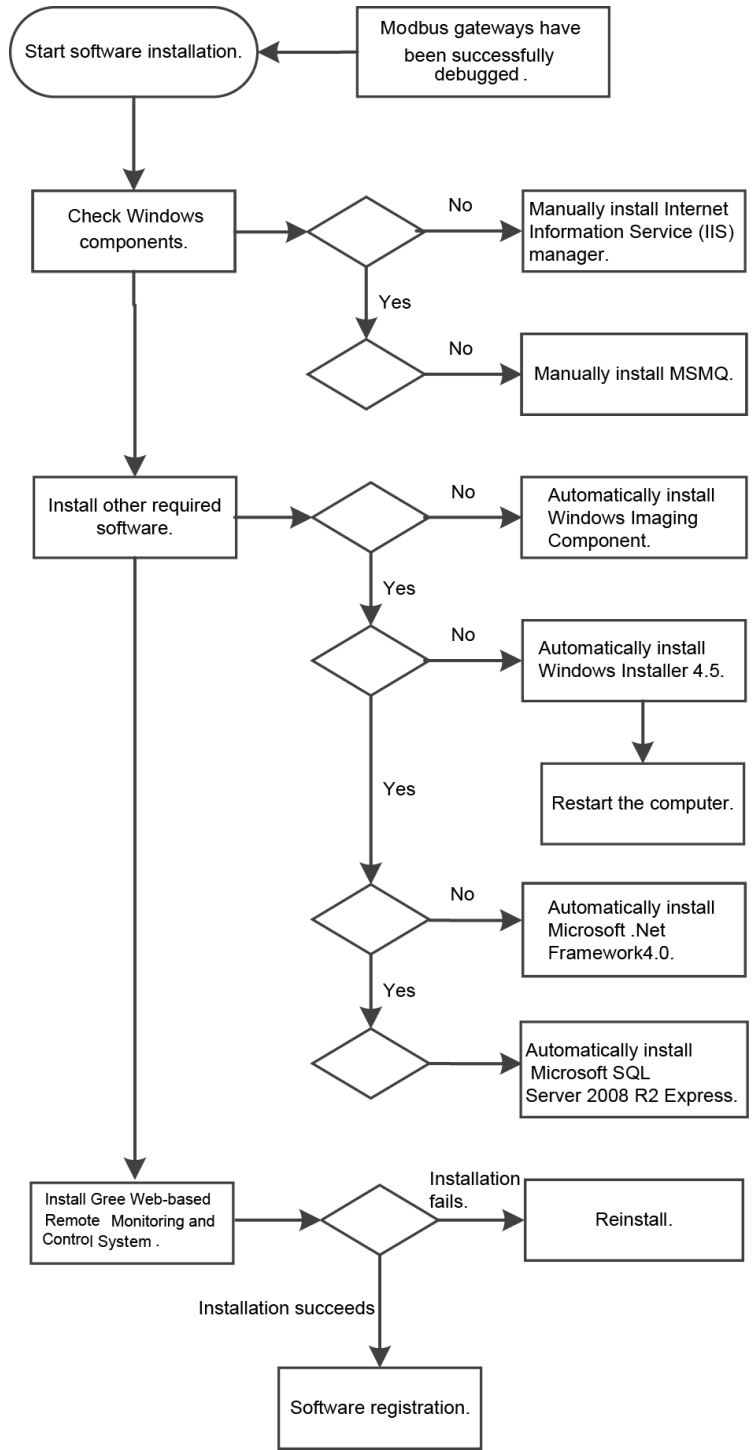

This is a simplified software installation procedure. In practice, the software has realized “one-click setup”. You only need to select a proper OS for installation. See the following page:



For details, read the following section.

2.5.3.1 Installing Gree CAC Remote Monitoring System

1. Double click BASGuide.exe and the Setup Wizard is enabled. Follow the steps to install the software.

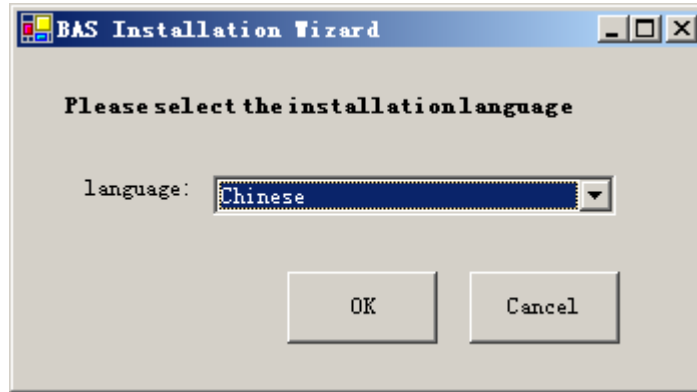

2. If the PC is not installed with Windows Installer 4.5, click “Accept” in the displayed window and the Setup Wizard will install Windows Installer 4.5 for you.

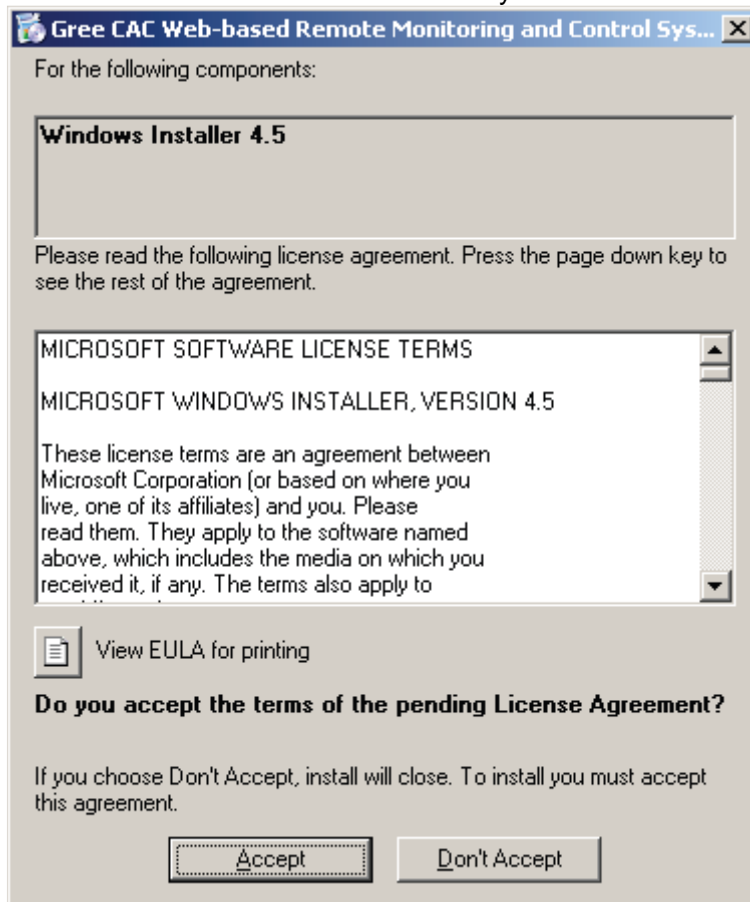

3. If the PC is not installed with Microsoft.NET Framework 4, click “Accept” in the displayed window and the Setup Wizard will install Microsoft.NET Framework 4 for you.

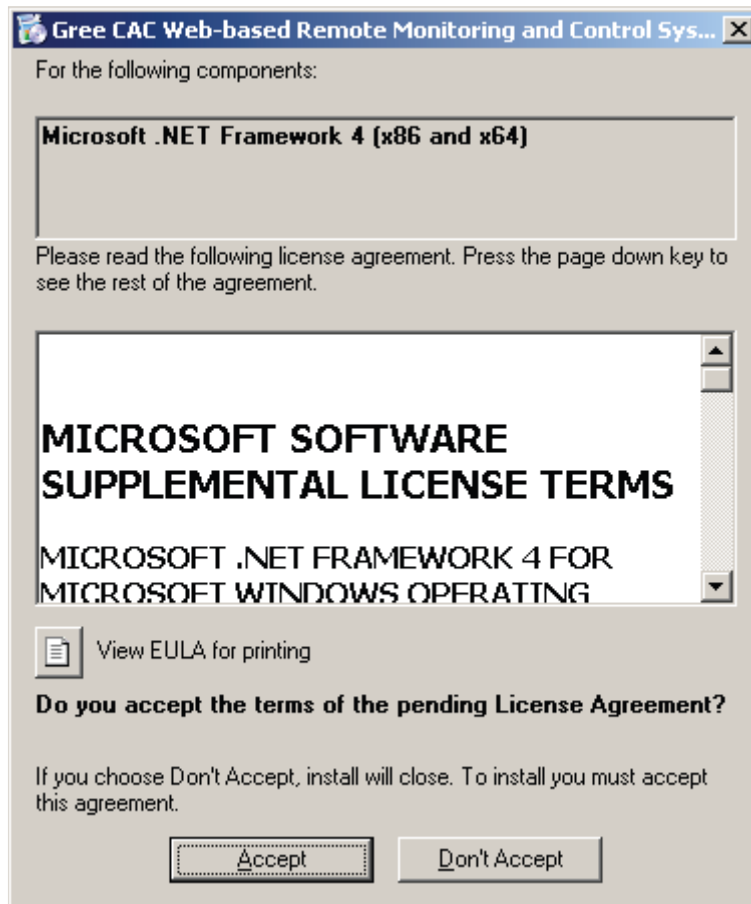

4. If the PC is not installed with Microsoft SQL Server 2008 R2 Express, click "Accept" in the displayed window and the Setup Wizard will install Microsoft SQL Server 2008 R2 Express for you.



5. If the PC is not installed with Windows Image Component, click "Accept" in the displayed

window and the Setup Wizard will install Windows Image Component for you.

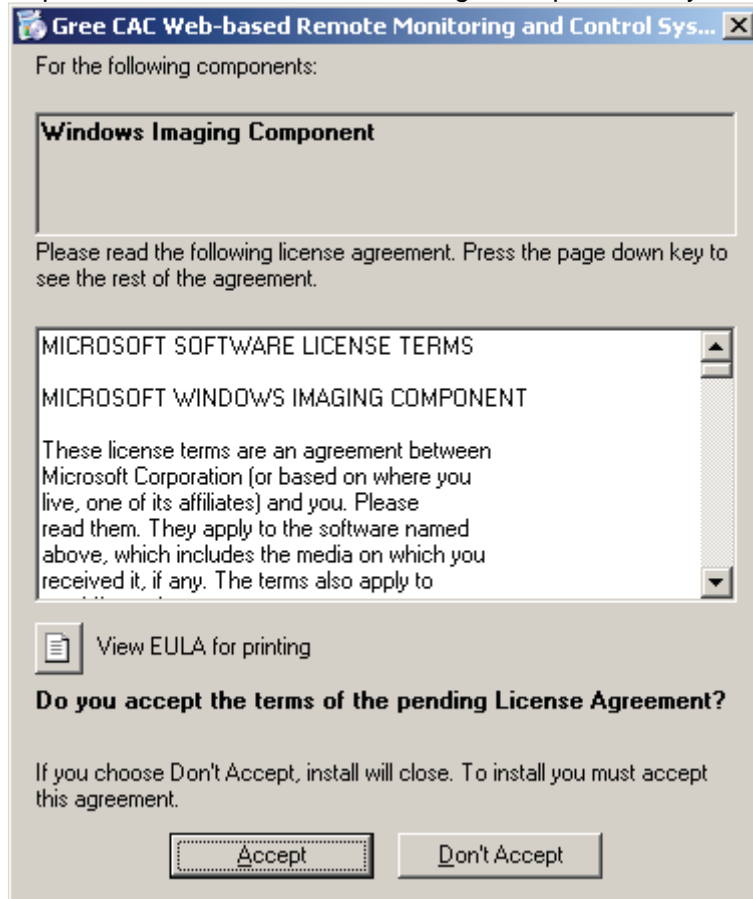

6. Click "Next" in the displayed window and select "I Agree" on the "License Agreement" page. Click "Next" to install Windows Image Component.

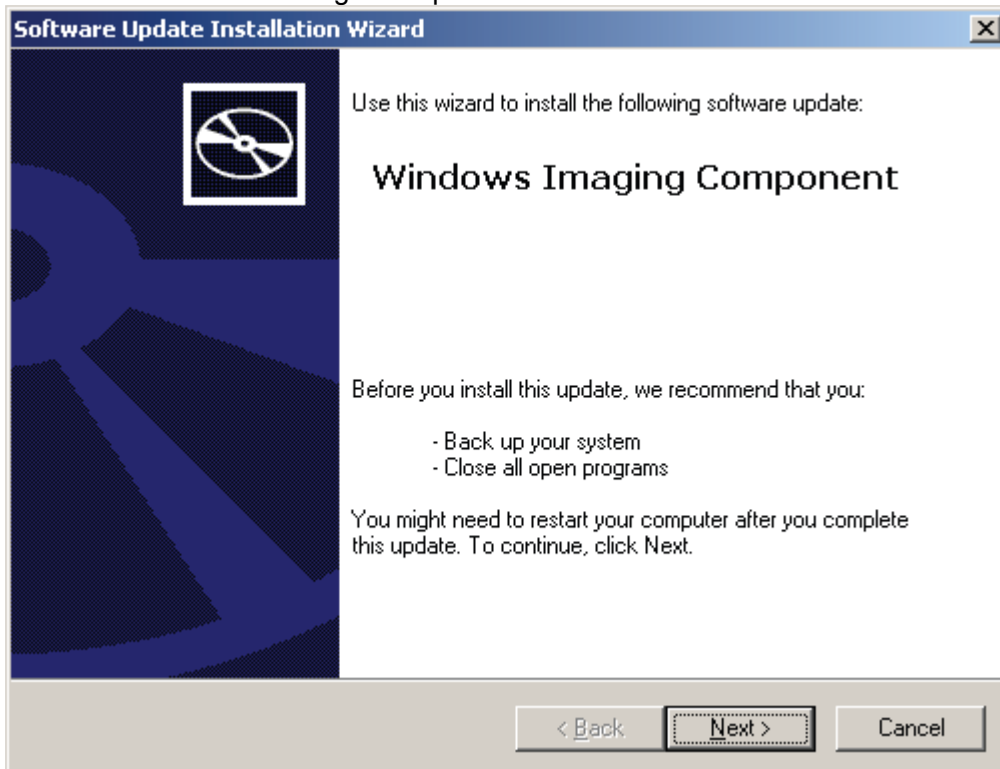



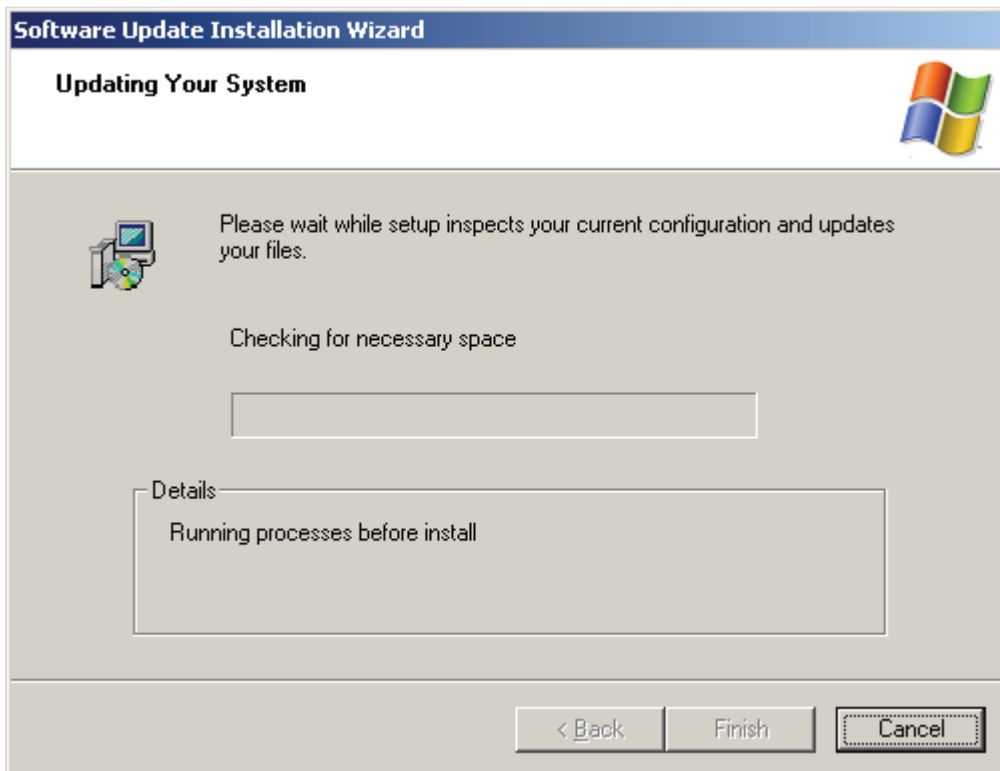
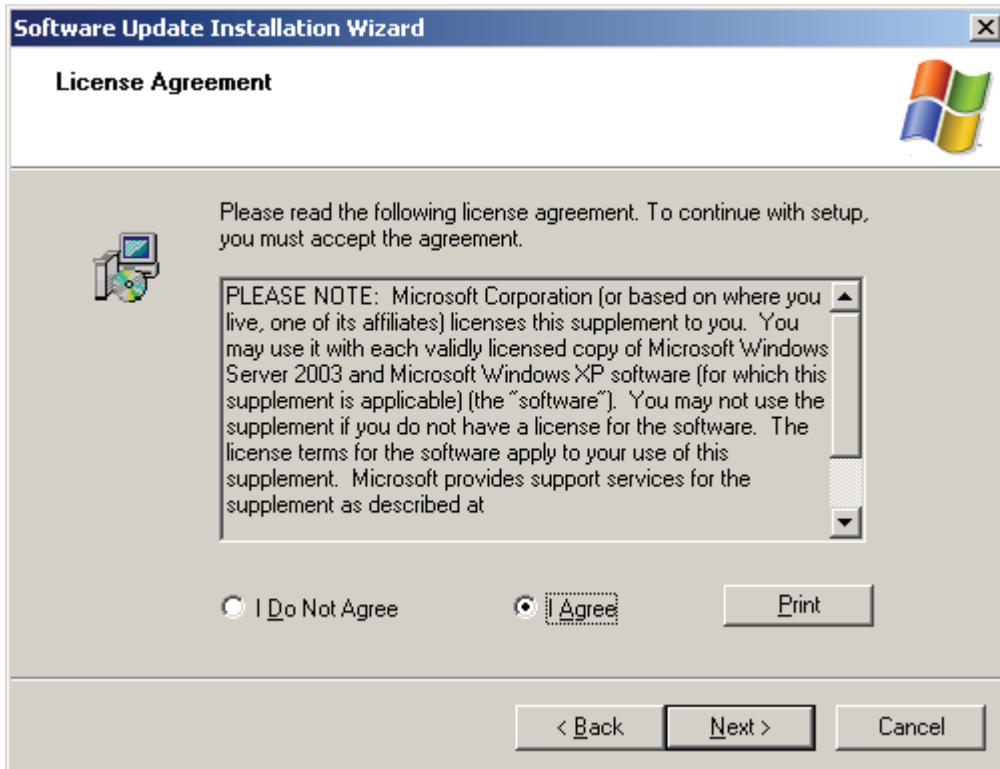

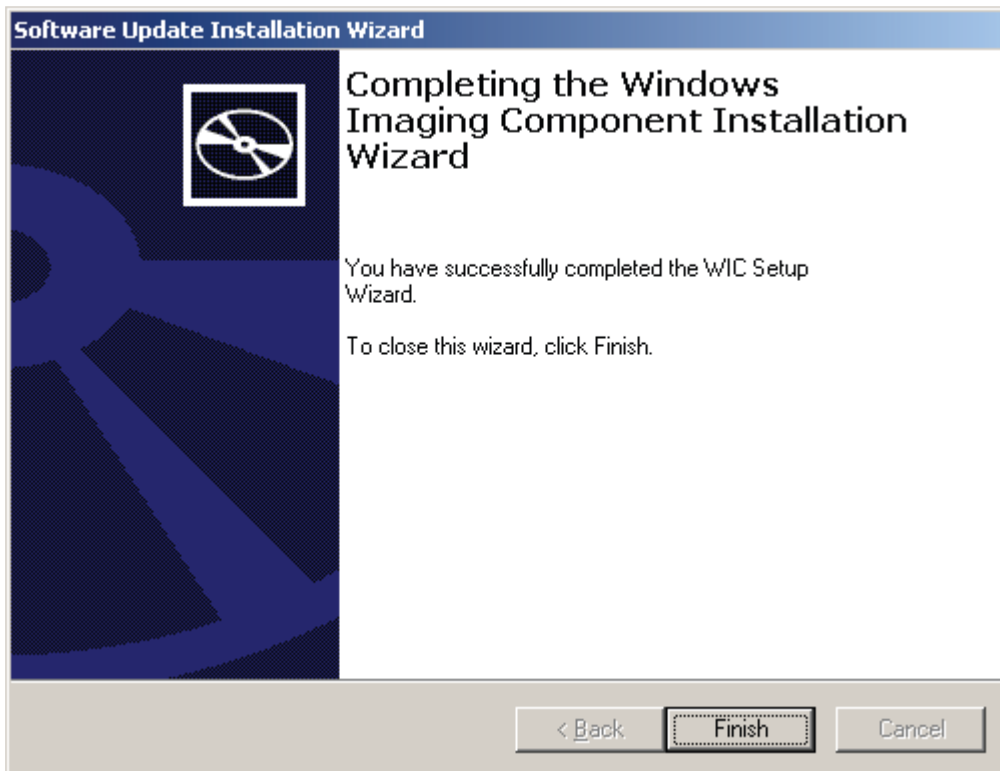

7. After Windows Imaging Component is installed, the Wizard begins installing Windows Installer 4.5. A system restart window will be displayed after Windows Installer 4.5 is installed. Restart the system so as to continue.

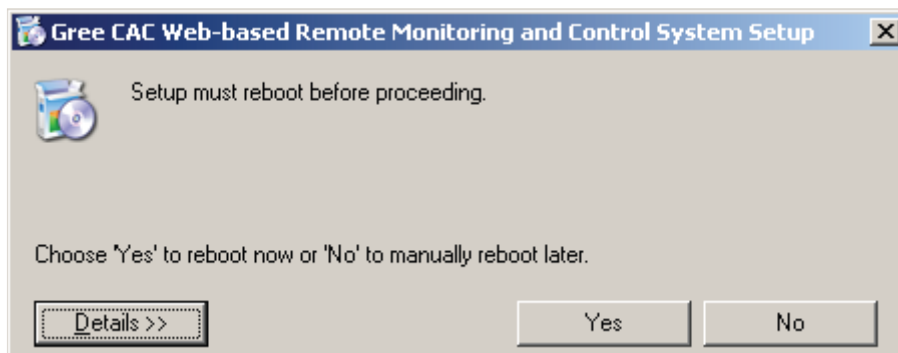
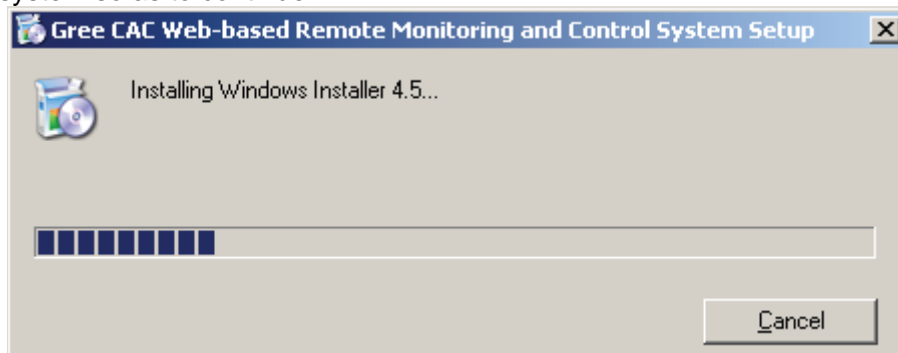

8. After restart, the system will continue to install Microsoft .NET Framework 4.0.

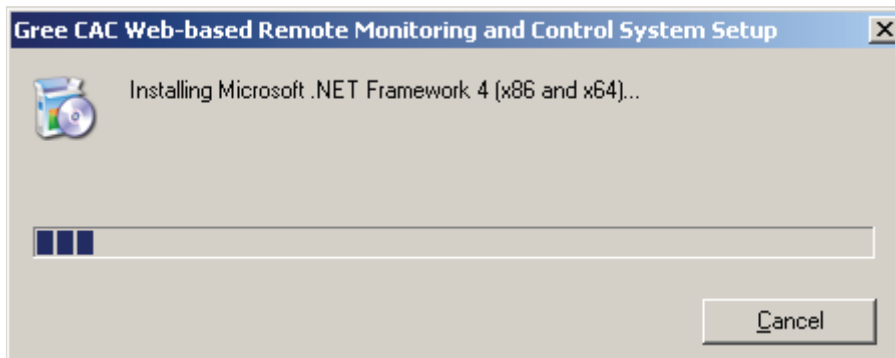

Note:

If the Microsoft .NET Framework 4.0 window does not appear, double click the BASGuide.exe file to enter the Setup Wizard. The components that have been installed will not be prompted and you can continue to install Microsoft .NET Framework 4.0.

9. After Microsoft .NET Framework 4.0 is installed, the system begins to install Microsoft SQL Server 2008 R2 Express, which takes a long time. Note that if your PC has been installed with this software, the Wizard will not prompt you to install.

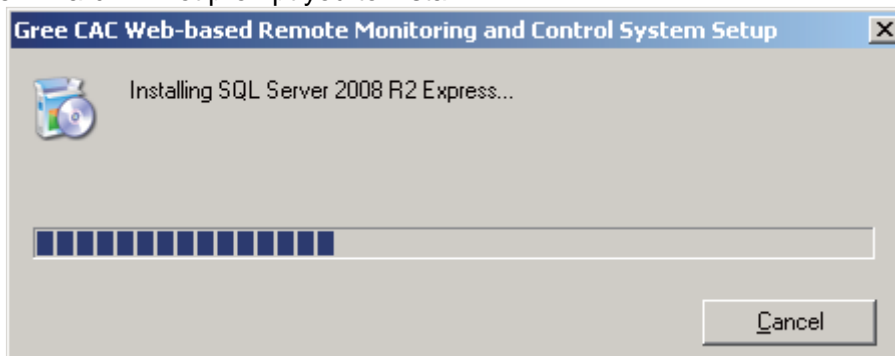

10. After Microsoft SQL Server 2008 R2 Express is installed, the Setup Wizard will automatically detect whether your system has installed IIS6.0 or later versions and MSMQ. If not, it will prompt you to install. Click "Yes" in the displayed window.

11. While IIS or MSMQ is being installed, do not close the following window. It will automatically close after installation is finished.

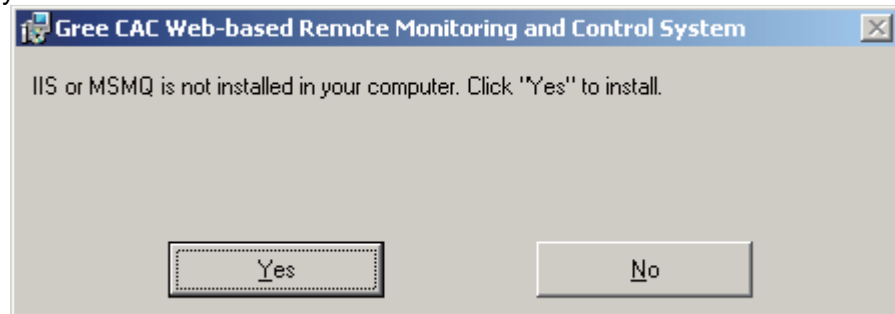

12. When all components are prepared, the Setup Wizard instructs you to install Gree CAC Remote Monitoring System. Click "Next".

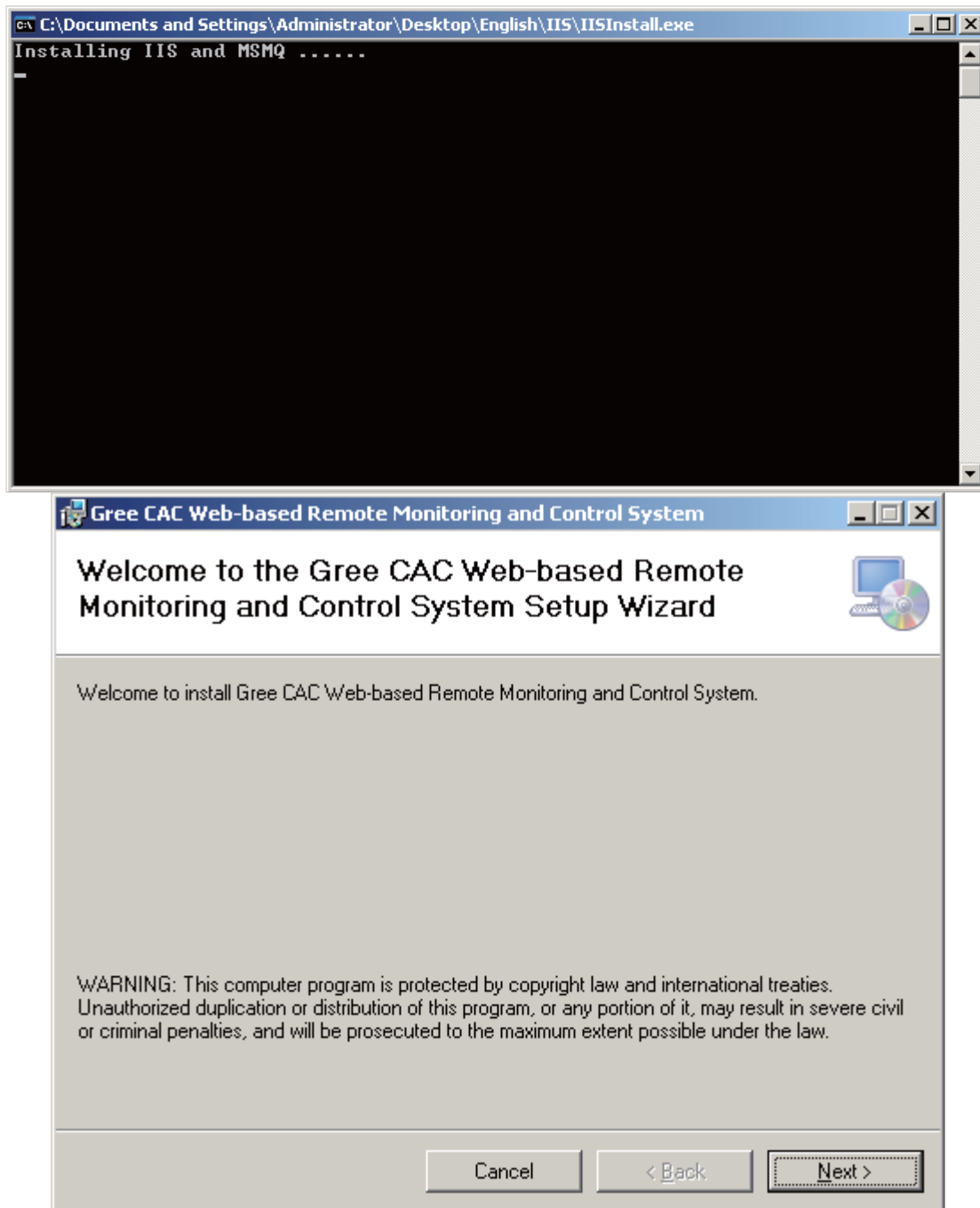

11. In the displayed window, select "I Agree" and click "Next" to continue.

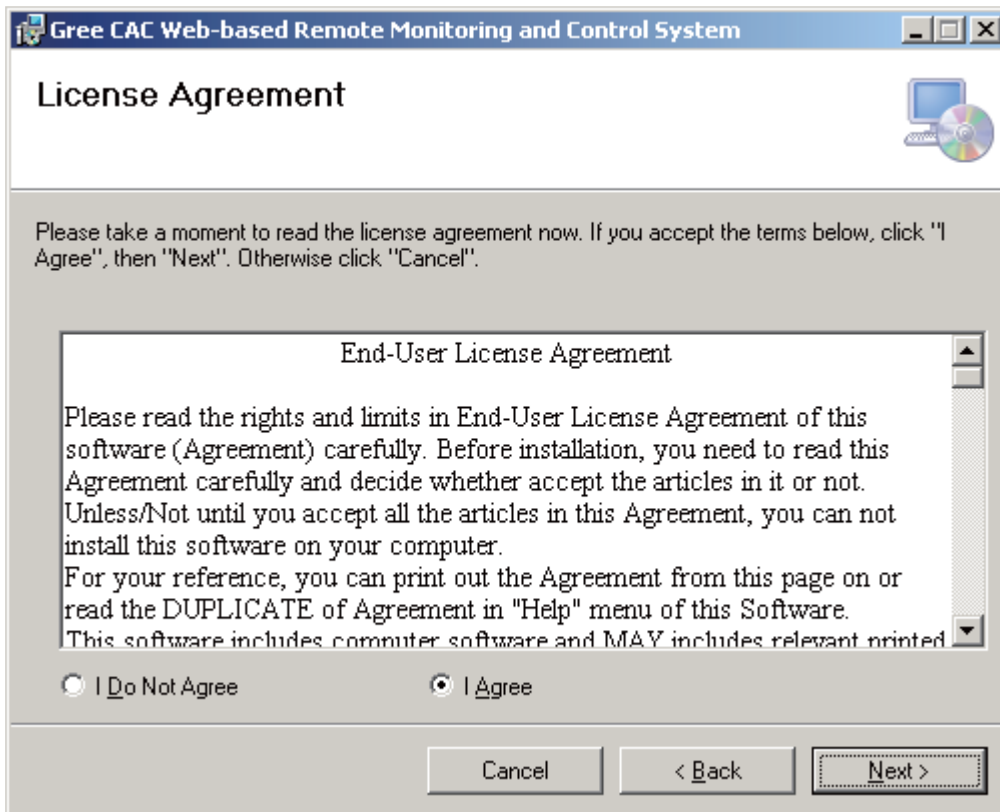

12. Select a path for installing the software. The default path is recommended. Continue to click "Next".

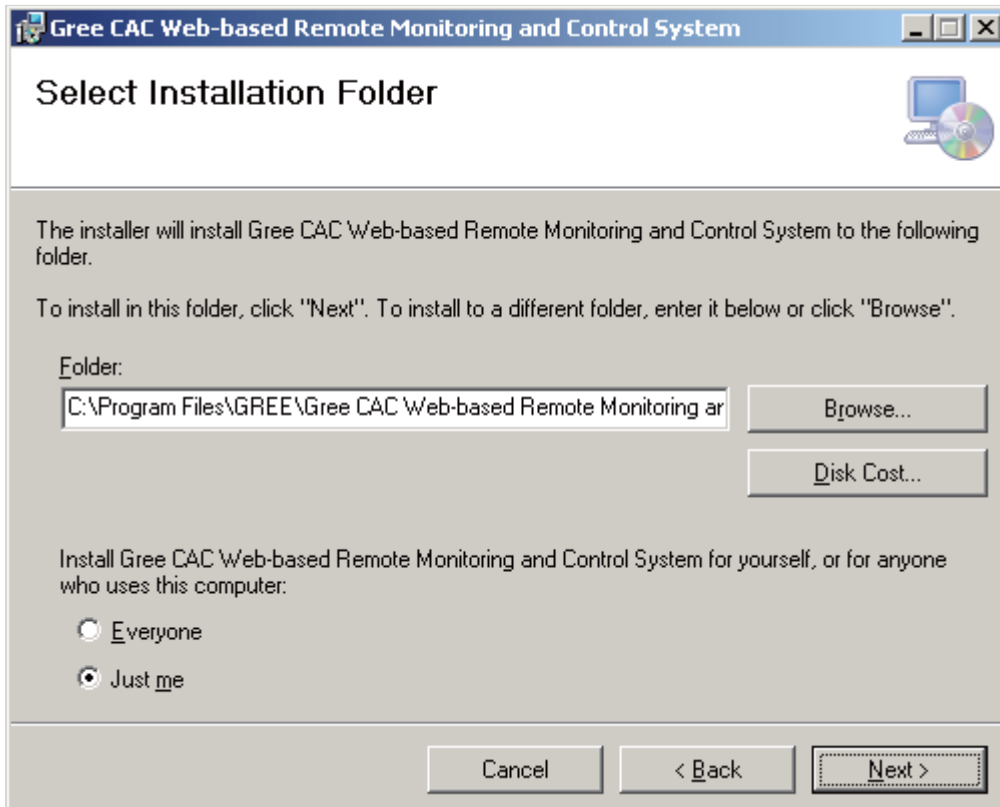

13. When installation succeeds, "BAS Manager" service is displayed. This service is an accompanied service. Do not click "Stop".



14. Several seconds later, the software SN window will appear. Click “Close” to complete installation.

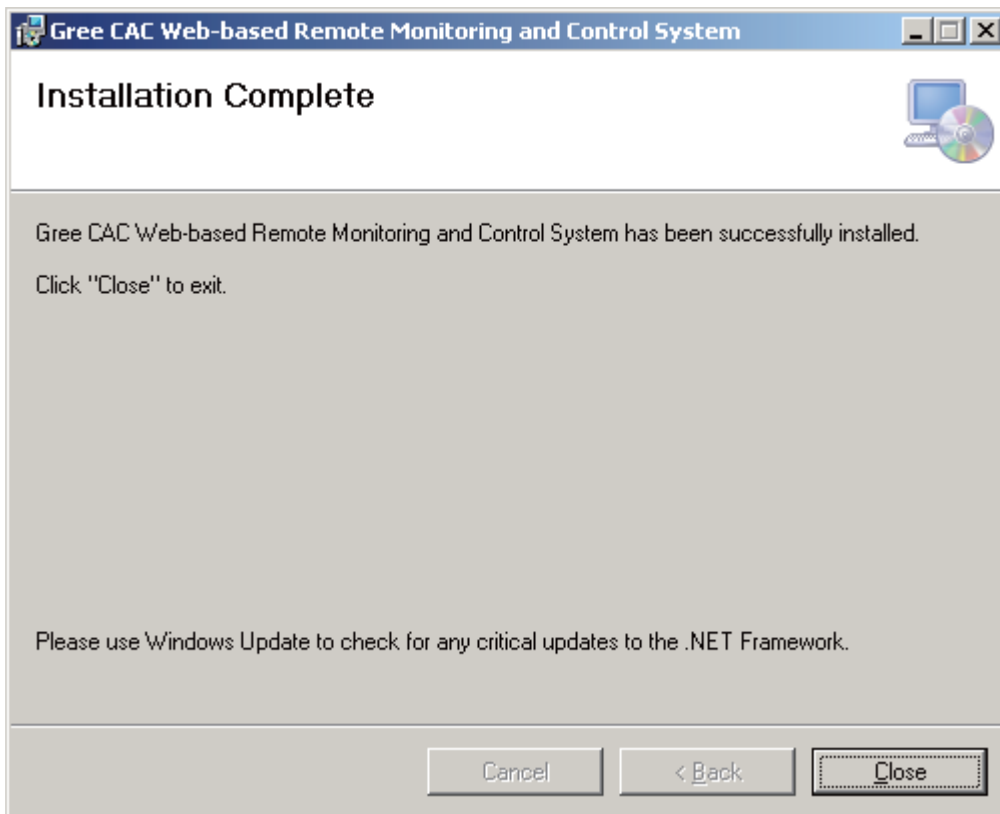

**Note:**

Send your software SN to a dealer of Gree. If you do not activate the software, it can be used for a trial period of 30 days. Use the activation code the dealer sends to you to activate your software, and you can continue to use it.

**2.5.3.3 Registration**

Software activation procedure is as follows:

Choose “Start” -> “All Programs” -> “Gree CAC Remote Monitoring System” -> “Activate Software” and enter the correct activation code.



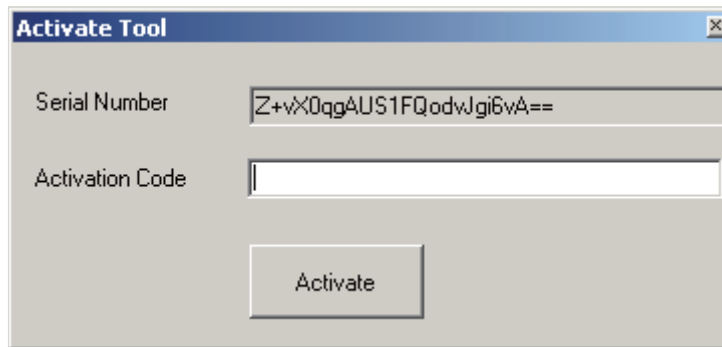

### 2.5.4 Uninstallation

Software uninstallation procedure is as follows:

1. Stop the “BAS Manager” service.
2. Choose “Start” -> “Settings” -> “Control Panel” and double click “Add or Remove Programs”.

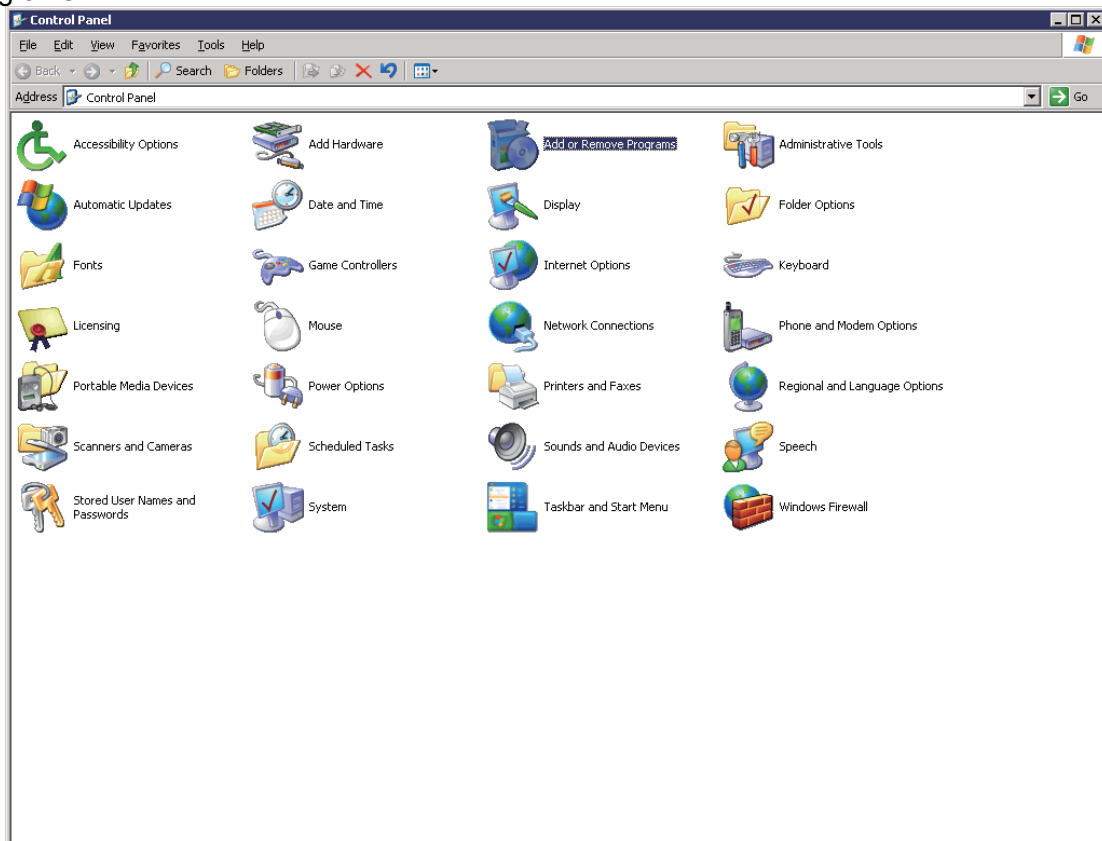

3. In the “Add or Remove Programs” window, select “Gree CAC Web-based Remote Monitoring and Control System” and click “Delete” to delete the software.

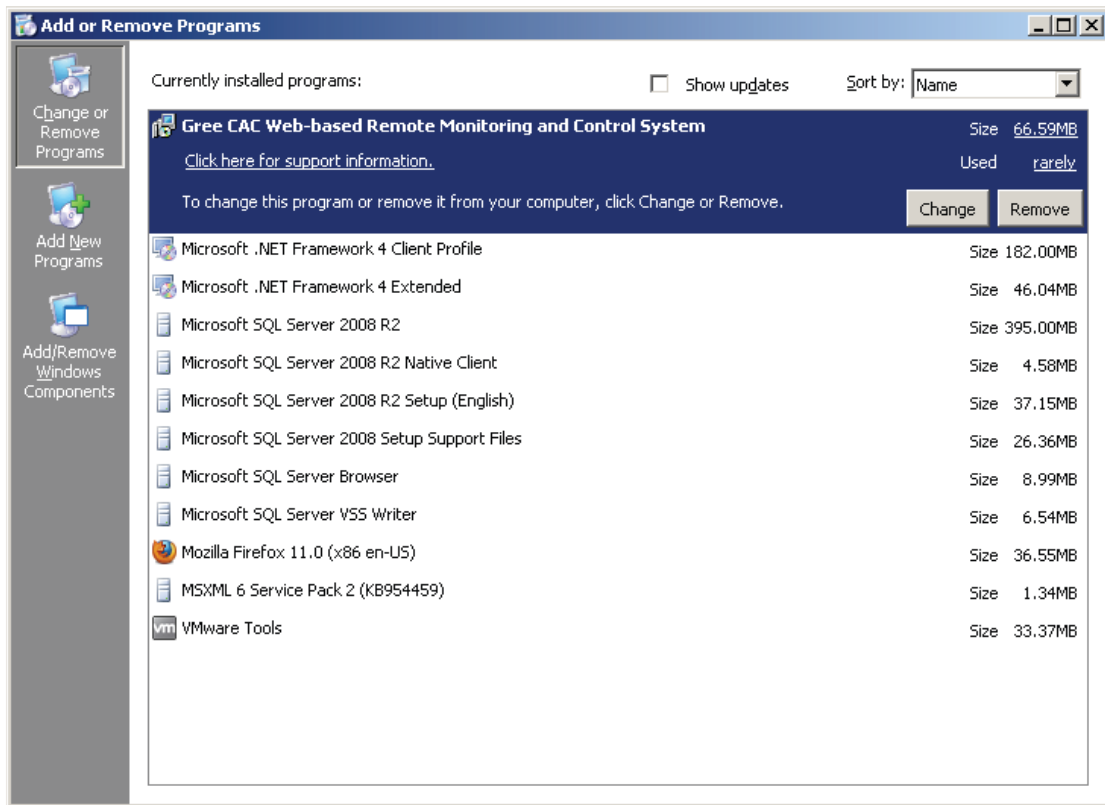



## 2.6 Software Debug

This part describes how to debug the software after it is successfully installed and the client can communicate with the server (LAN-based access). For detailed software debug procedure, please refer to the Help of the software.

### 2.6.1 Debug Flowchart

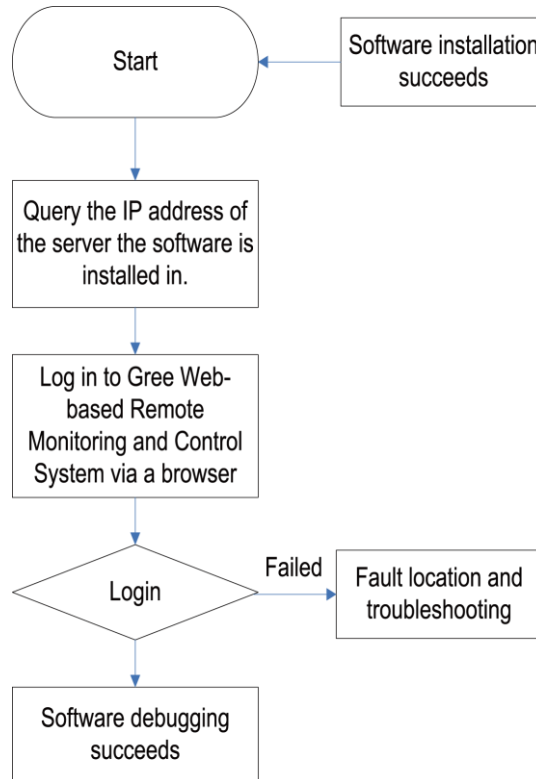

This is a simplified software debug procedure. For details, read the following section.

### 2.6.2 Debug Procedure

1. Querying IP address of the server the software is installed in  
The IP address of the server PC can be queried via the Network Neighborhood.
  - a. Right click "Network Neighborhood" and choose "Properties". "Network Connect" page appears.

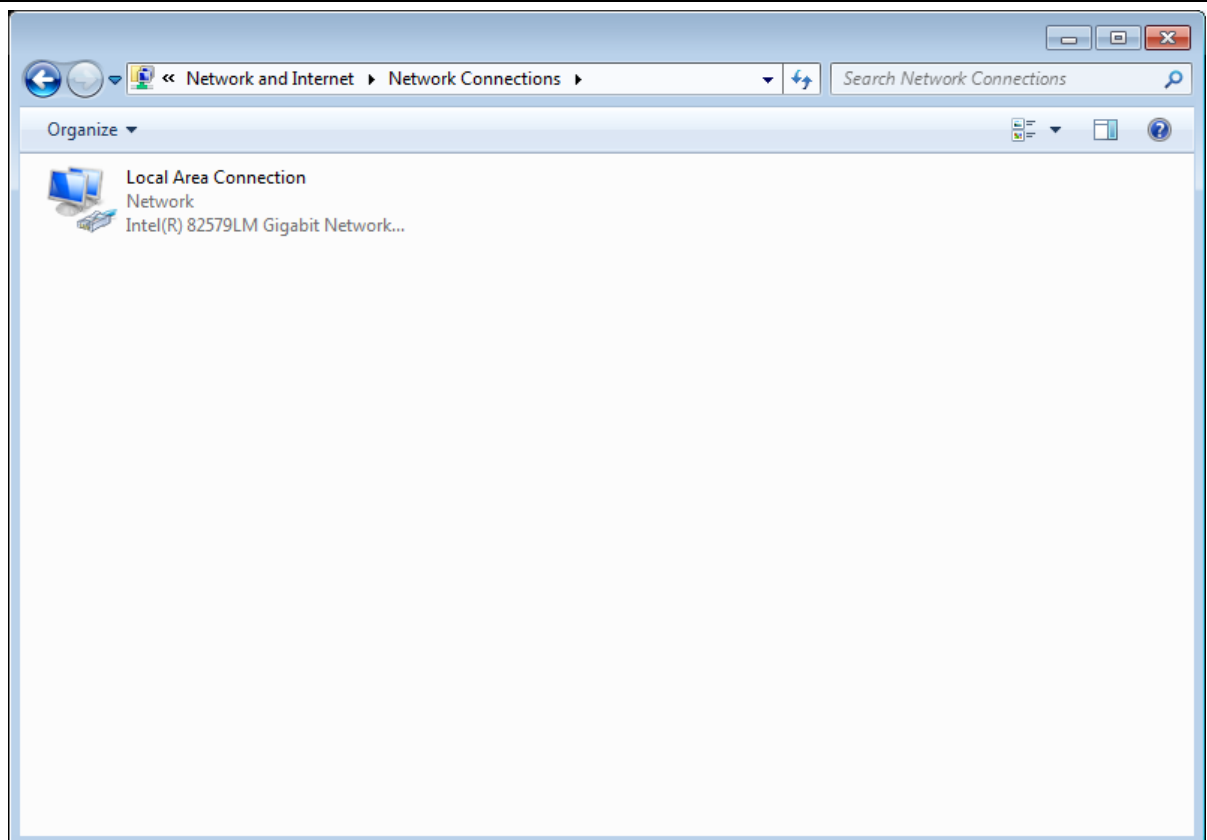

b. Right click “Local Connect” and choose “Local Connect Properties”.

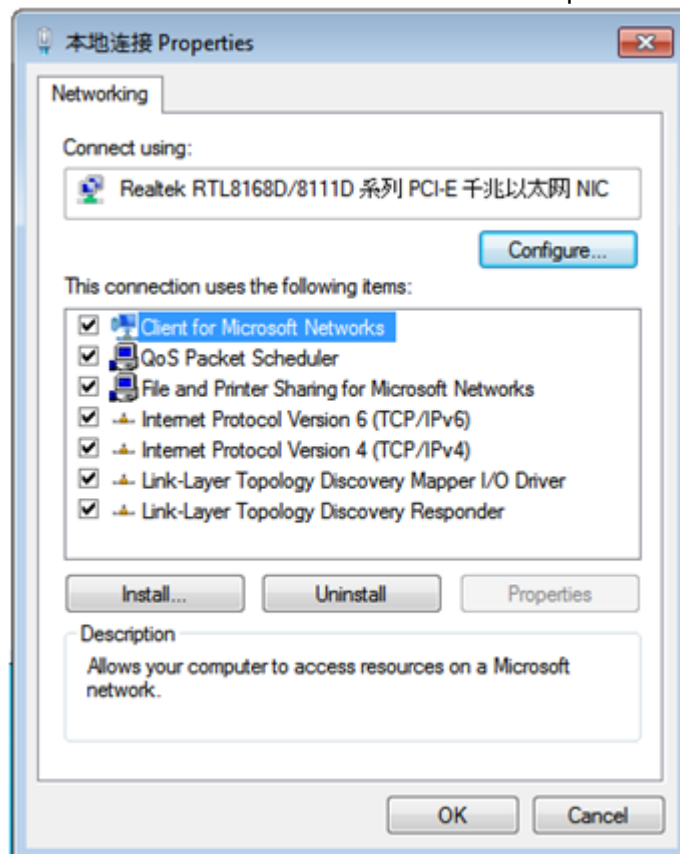

c. In the “Local Connect Properties” window, select “Internet (TCP/IP)” and click “Properties”. The “Internet (TCP/IP) Properties” window appears. The “IP Address (I)” is the IP address of the server PC. The following figure shows that the IP address of the PC is 172.16.63.245.

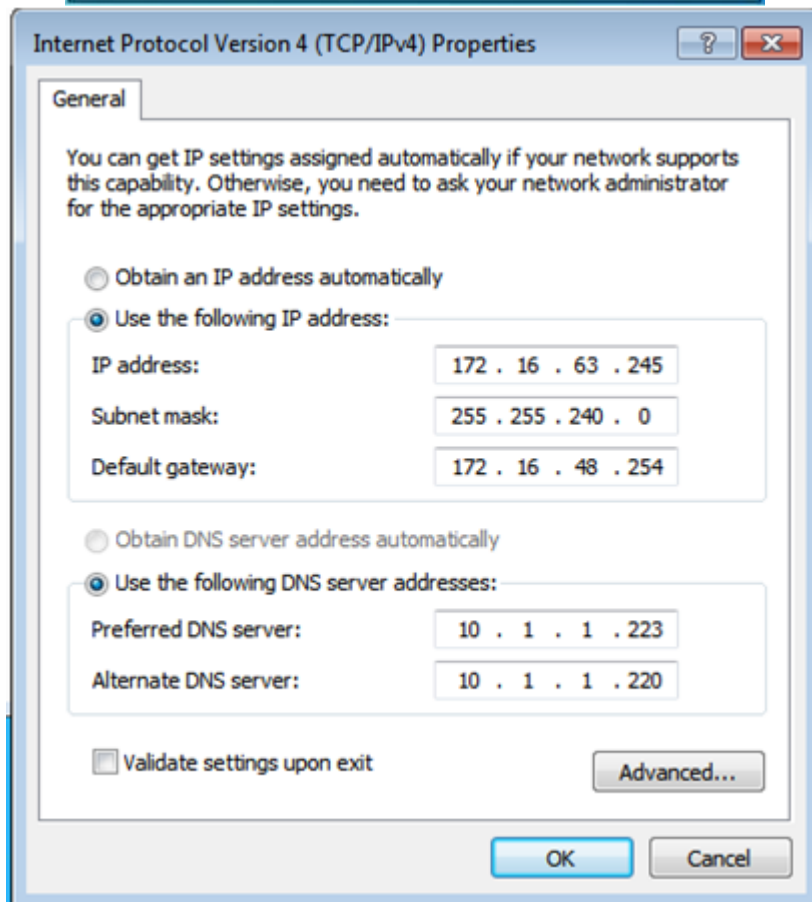
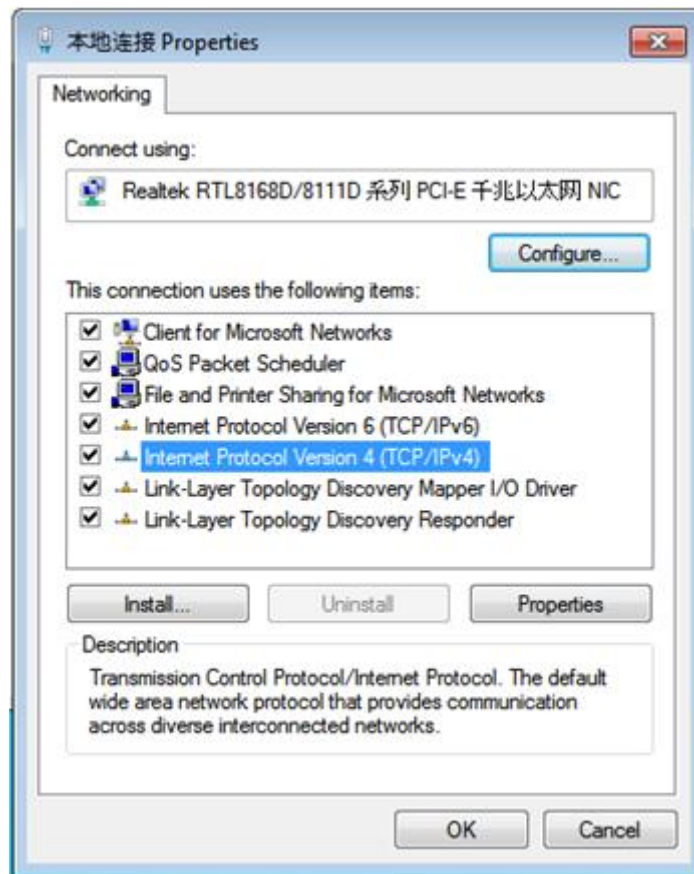

2. Logging in to Gree CAC Remote Monitoring System via a browser
  - a. Open a browser (for example, IE) on a PC and enter the IP address of the server.  
Note: Make sure the PC and the server PC are in the same LAN and can communicate with each other.



b. Enter the IP address in the address bar and click "To" to switch over to the system login page, as shown in the following figure:

Note: If your browser is set to English, the login page will be English as well.

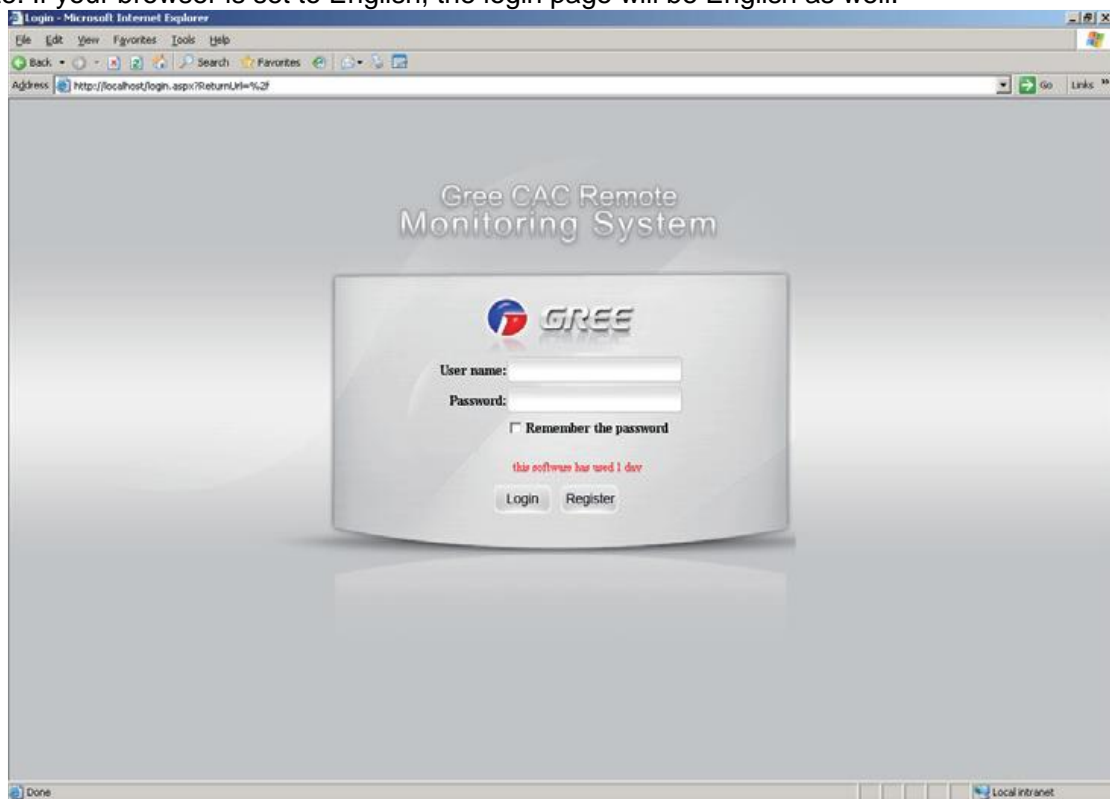

If the following page appears, the client PC cannot connect to the server. Possible cause is that the client PC or the server PC does not connect to the LAN, causing both to fail to communicate.

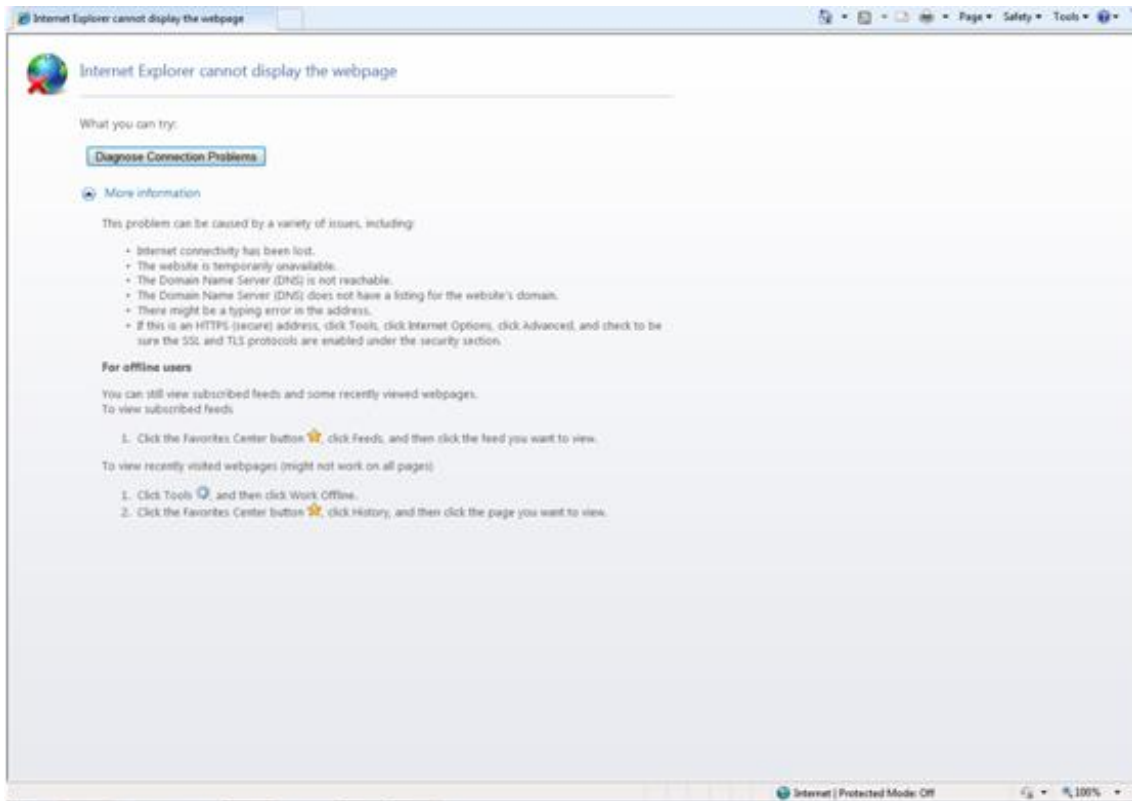

Troubleshooting procedure is as follows:

1. Check network lines of the server and client and make sure they connect to the LAN;
2. Ping the IP address of the server on the client (for detailed operation, refer to the maintenance chapter). If Ping succeeds, they can normally communicate; otherwise, the software cannot be used.

c. Enter the default username and password of the Administrator and click "Login". If the following system homepage appears, system debug succeeds and the software can be used.

Default username of the Administrator: admin; password: basstart

Note:

This debug method is for the Administrator only. Other roles are not allowed to use this method.

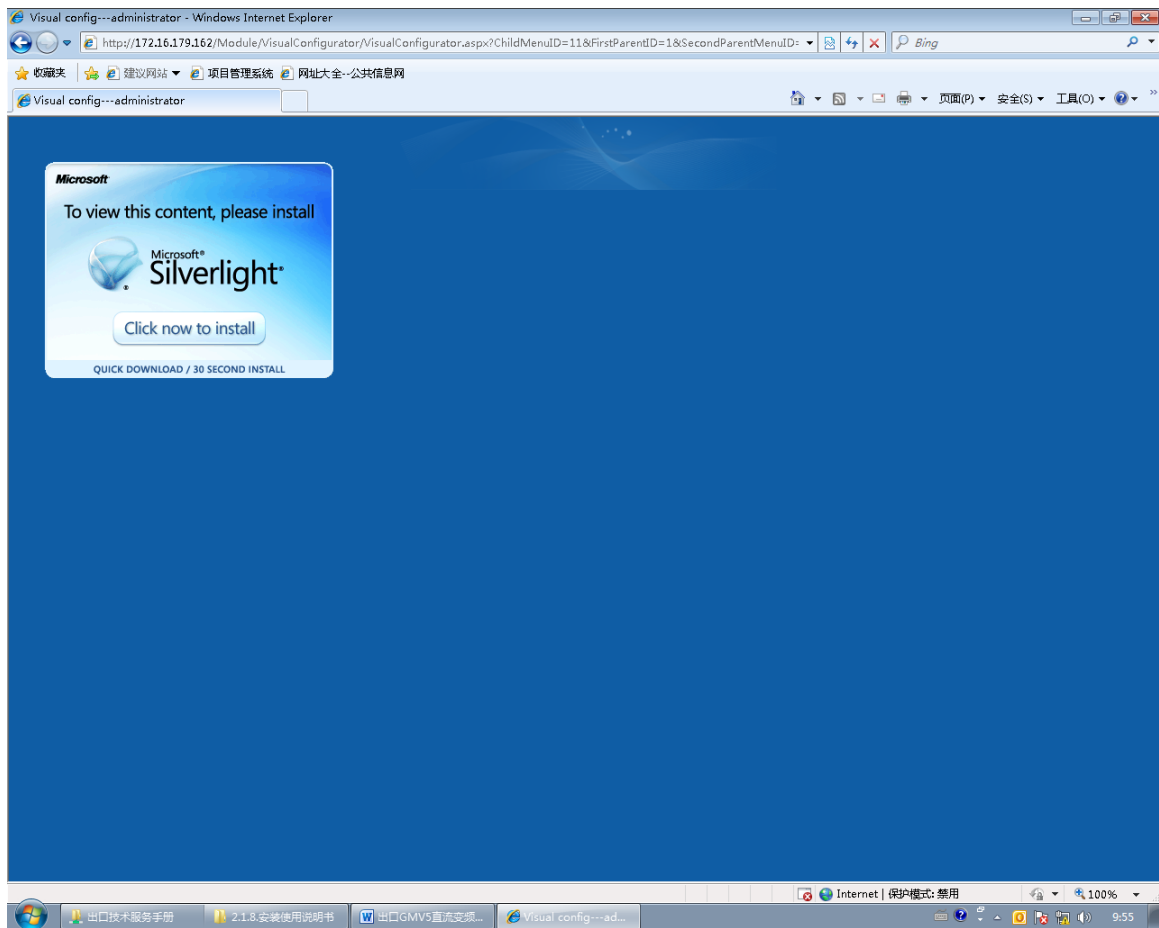

**Note:**

The preceding figure is the page showed for initial server access. Software visualization requires Microsoft Silverlight to support. Therefore, a Microsoft Silverlight installation wizard will be prompted. Click “Click now to install” to install the plugin.

After Microsoft Silverlight is installed, the page is automatically refreshed, as shown in the following page:

# GMV5 DC INVERTER VRF UNITS SERVICE MANUAL

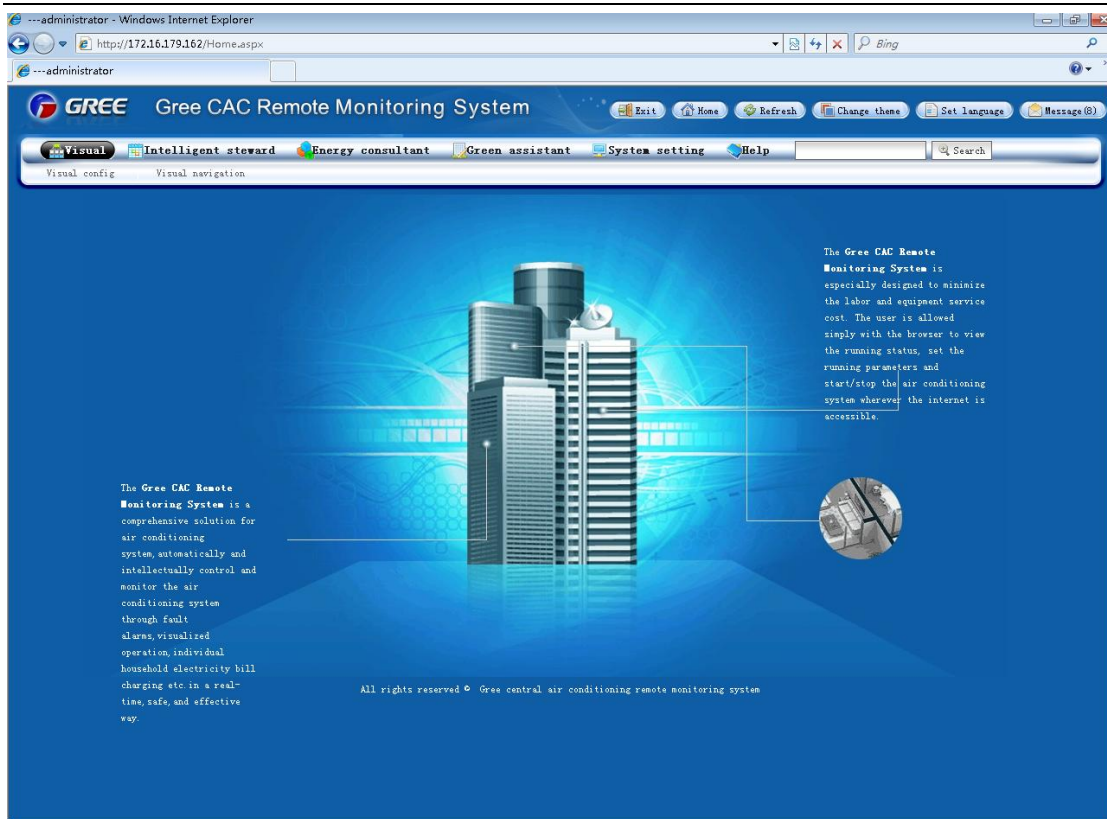

## 2.7 Remote Monitoring System Debug

After the remote monitoring system is installed and connected, follow the procedure below to debug it.

### 2.7.1 Cooling System Debug

Before debugging air conditioners, set the air conditioning systems first, including:

Step 1: Set the master ODU for the single system network and the centralized control address for the multi-system network.

① Check the DIP switch of the master ODU for each cooling system. For details, refer to part II “Introduction of Unit Function” in chapter II product debug.

② For the multi-cooling system network, check the address DIP switch of each cooling system. For details, refer to part II “Introduction of Unit Function” in chapter II product debug.

Step 2: Set offset of IDU numbers.

1. After multi-system connection and debug, press SW3 on the master ODU whose centralized control address is 0. The system enters function selection state and the following is shown on the master ODU:

By default, “A7” is displayed.

LED1		LED2		LED3	
Function code	Display mode	Current progress	Display mode	Current state	Display mode
A7	Flash	00	Flash	00	Flash

2. Press SW2 (▼) on the master ODU to select the function code n5 (setting of IDU number offset) and press SW7 to confirm. The following is displayed:

LED1		LED2		LED3	
Function code	Display mode	Current progress	Display mode	Current state	Display mode
n5	ON	00	Flash	00	Flash

3. While number offset waits for being confirmed, press SW7 to enter number offset state. “Press SW7 to confirm” is displayed.

LED1		LED2		LED3	
Function code	Display mode	Current progress	Display mode	Current state	Display mode
n5	ON	00	ON	00	ON

In this case, all IDU numbers will be automatically offset. One minute later, conflict is addressed and the system returns to normal. The offset can be set on only the master ODU whose centralized control address is 0.

Note: If the quantity of conflict IDU numbers is not large, you are advised to manually set them using Gree Debugger, control panel, or remote control. Manual setting is applicable to intra-ODU conflicts only, not affecting numbers of other IDUs. If the quantity is large, automatic offset is recommended, which is easy to realize. However, numbers of normal ODU may be altered. Automatic setting is applicable to initial installation and debug.

### 2.7.2 Communication Debug Between Modbus Gateways and Air Conditioning Units

Step 1: Set matched resistance of CAN2 bus.

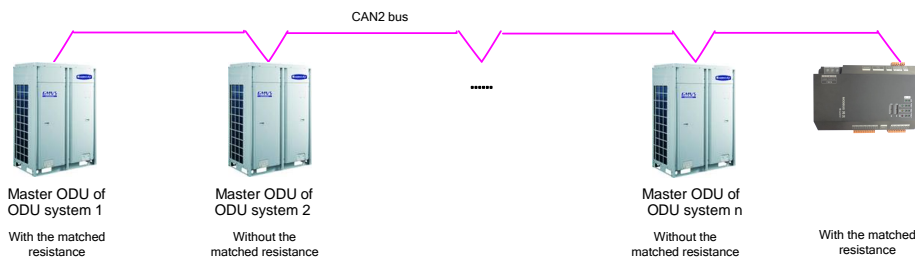

As shown in the preceding figure, the master ODU and the Modbus gateway at both ends of the CAN2 bus need to be configured with matched resistance.

The following figure shows how to set matched resistance on the Modbus gateway at the end of the CAN2 bus:



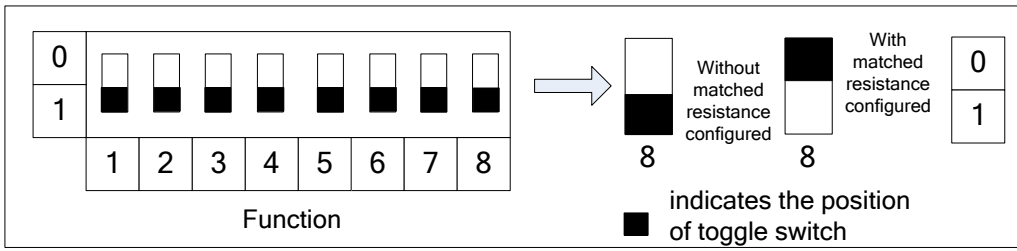

The following figure shows how to add matched resistance on the master ODU:

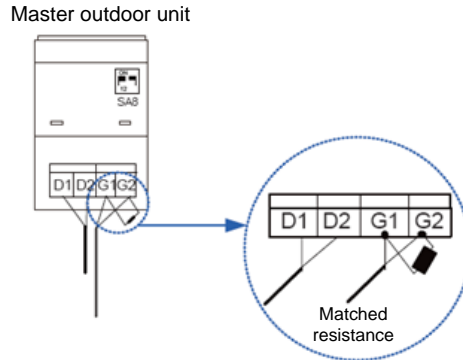

Step 2: Power off air conditioning units and Modbus gateways and then power them on.

Step 3: View communication LEDs.

Check whether the CAN\_RX LED corresponding to the Modbus gateway is flashing. If not, check whether the G\_TX LED corresponding to the master ODU whose centralized control address is 0 is flashing or steady on. If not, check communication lines and DIP settings.

### 2.7.3 DIP Switch Setting for Modbus Gateways

Step 1: Set Modbus gateway address.

Refer to section “Hardware Debug” to set Modbus gateway address. Make sure the address DIP switch on the same Modbus bus is unique and ranges from 1 to 255.

Step 2: Set the number of first IDU.

According to the number range of IDUs to be processed by Modbus gateways, the first IDU should be numbered 1 or 129. For details, refer to section 1.4.2.4 “Hardware Debug”.

### 2.7.4 Communication Debug Between Modbus Gateways and Gree Remote Monitoring System

After Gree Remote Monitoring system is installed, perform the following steps:

Step 1: Configure Modbus serial port.

Choose “Start” -> “Gree CAC Remote Monitoring System” -> “Com Configuration”.

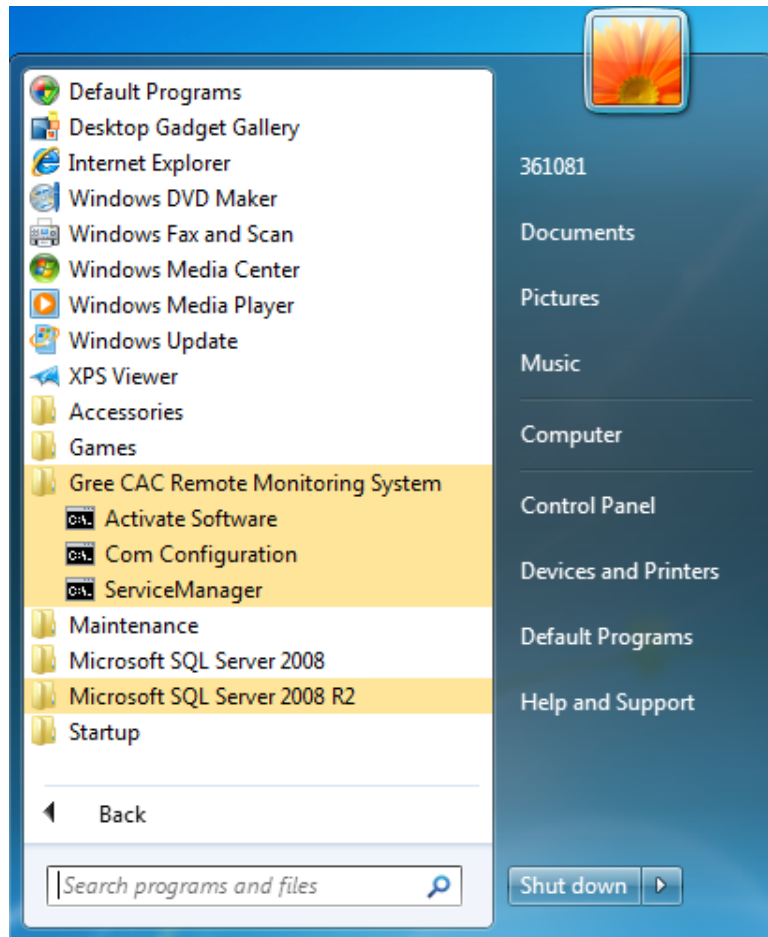

The following window is displayed. Select a serial port number and click “OK”.

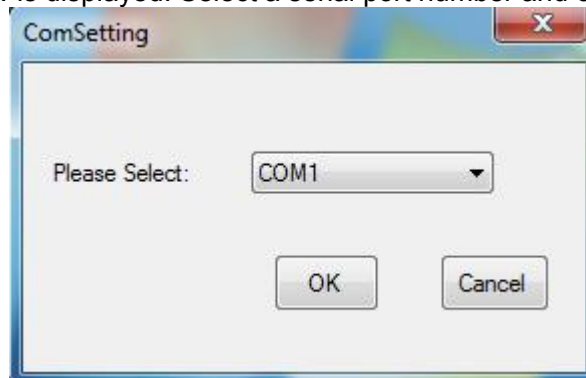

The following window is shown. Click “OK” to restart the PC.

Step 2: Enable BAS Manager.

There are two methods to enable BAS Manager.

Method 1

① Right click the BAS Manager icon in the status bar at the lower right corner on the desktop and choose “Open”.

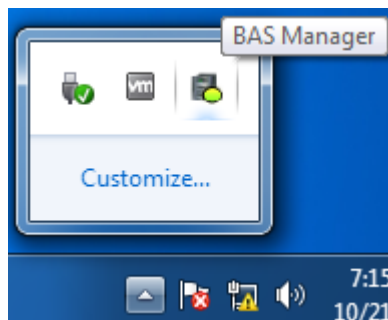

② In the displayed “BAS Manager” window, click “Start” to enable BAS Manager.

**Method 2**

Choose "Start" -> "All Programs" -> "Gree CAC Remote Monitoring System" -> "ServiceManager". In the displayed "BAS Manager" window, click "Start" to enable BAS Manager.

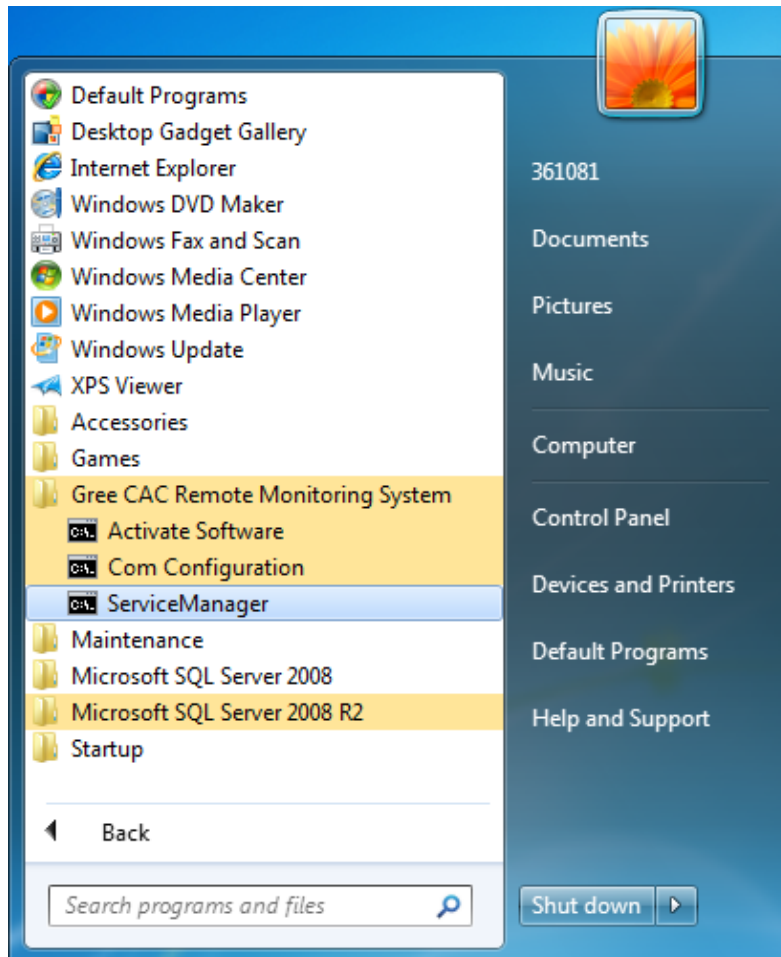

Step 3: Log in to Gree CAC Remote Monitoring System.



Step 4: Enter the “Visual config” page and click “Automatic detect”.

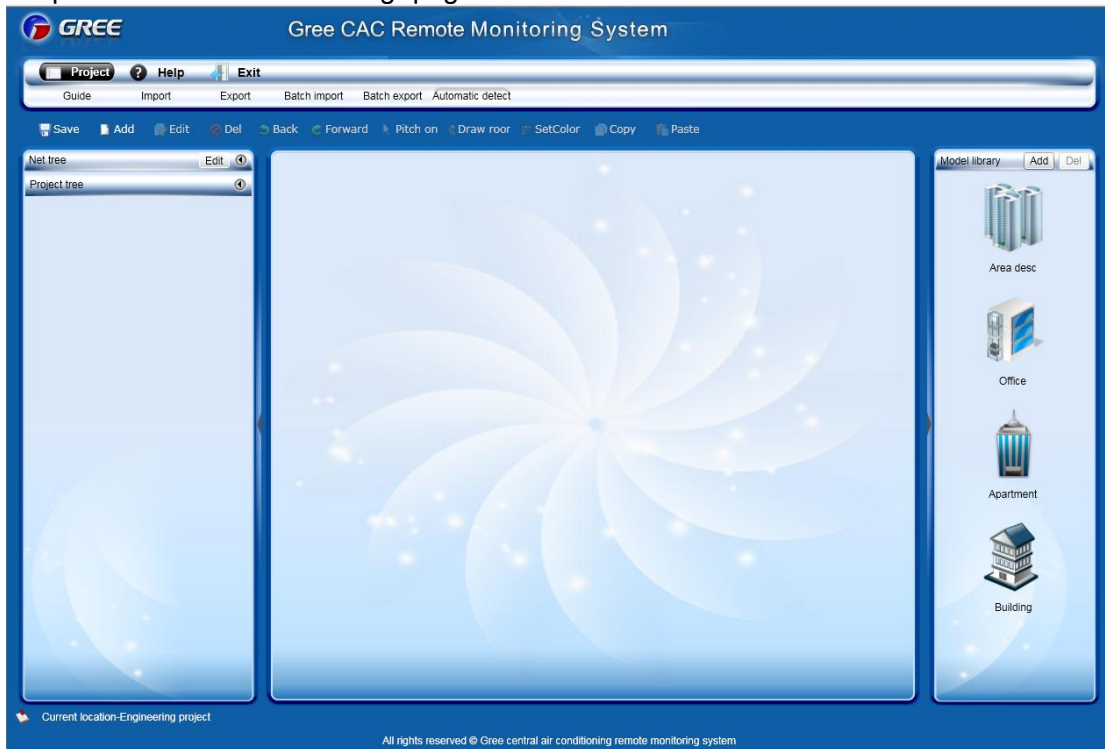

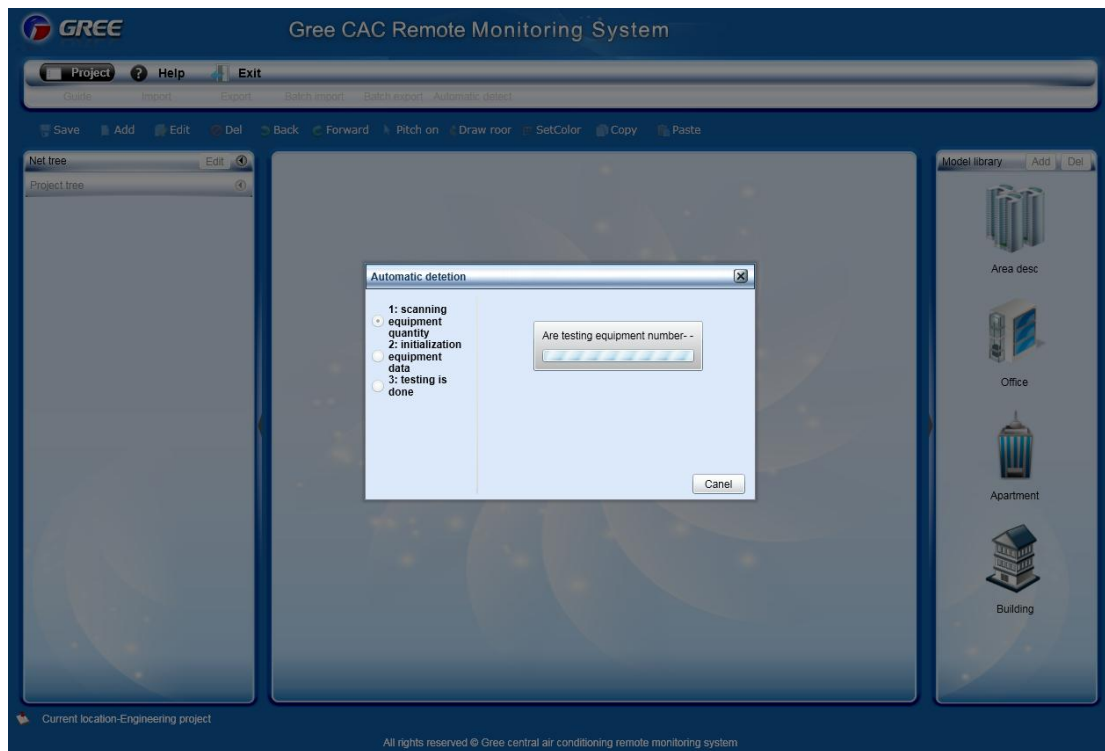

After detection, detected devices will be listed in the “Net tree”.

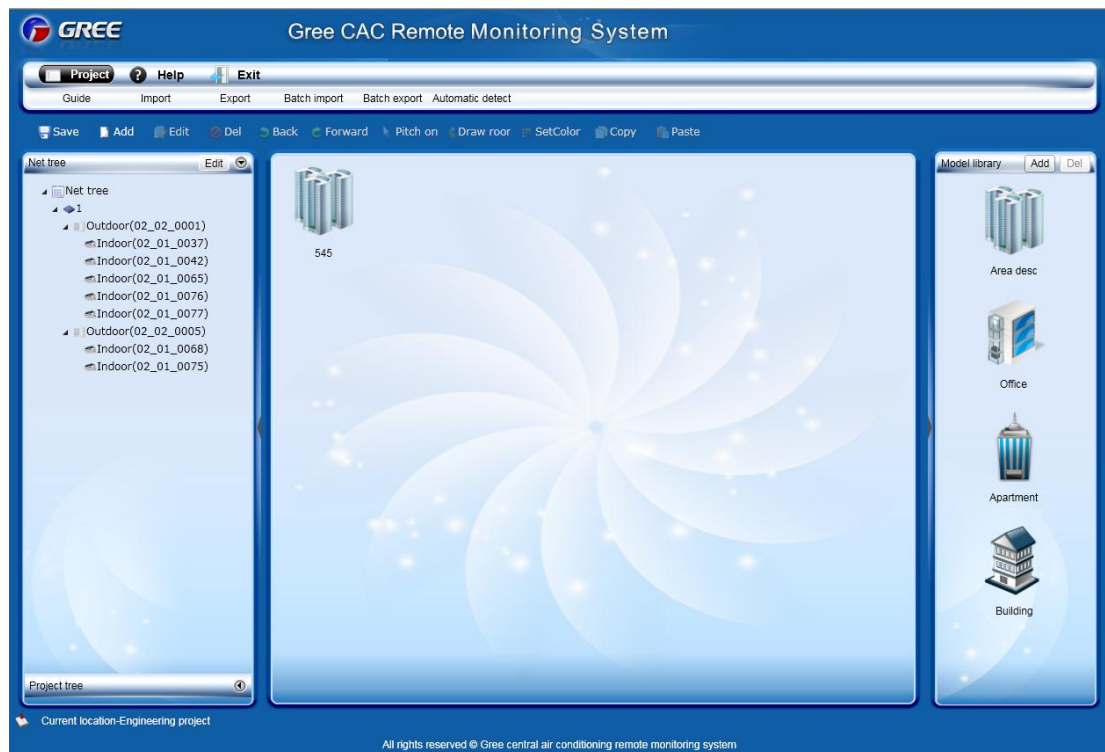

Step 5: Complete an air conditioner list.

Based on this list, users can check air conditioners of each building, storey, or apartment.

Step 6: Create a visualization project.

Enter the “Visual config” page and create a project in the “Project tree”.

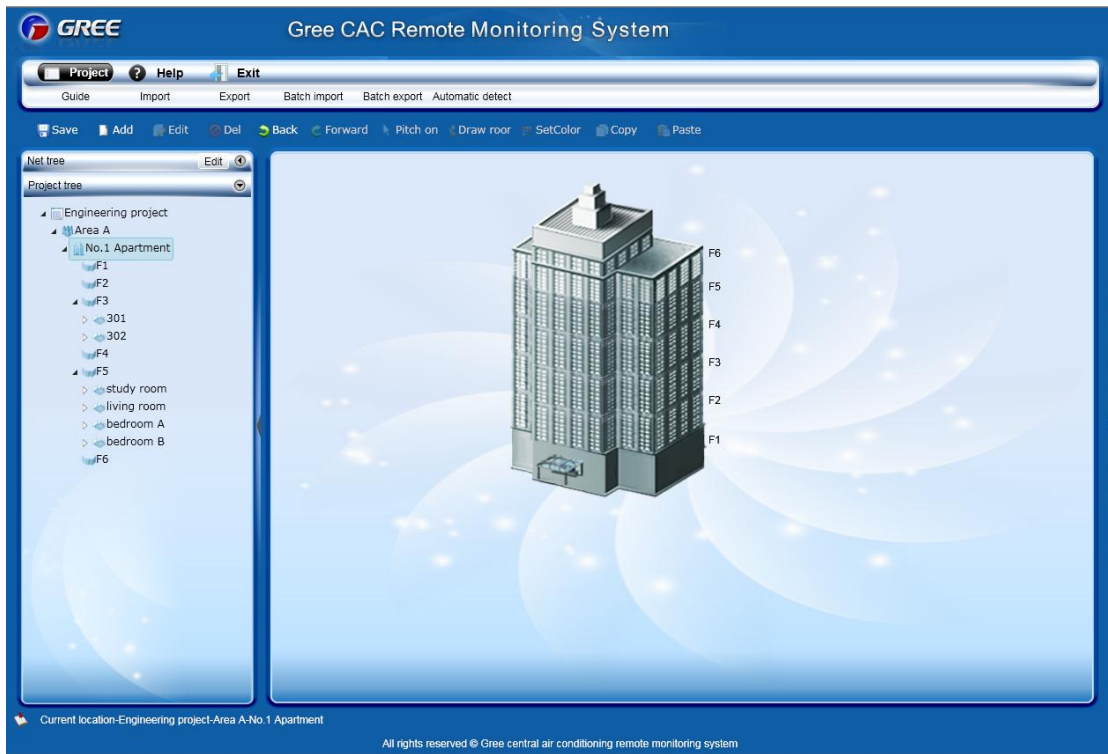

**Step 7: Define devices.**

Based on the air conditioner list, define devices.

Enter the “Visual config” page, select devices from the “Net tree”, and click “Edit” to define the selected devices.

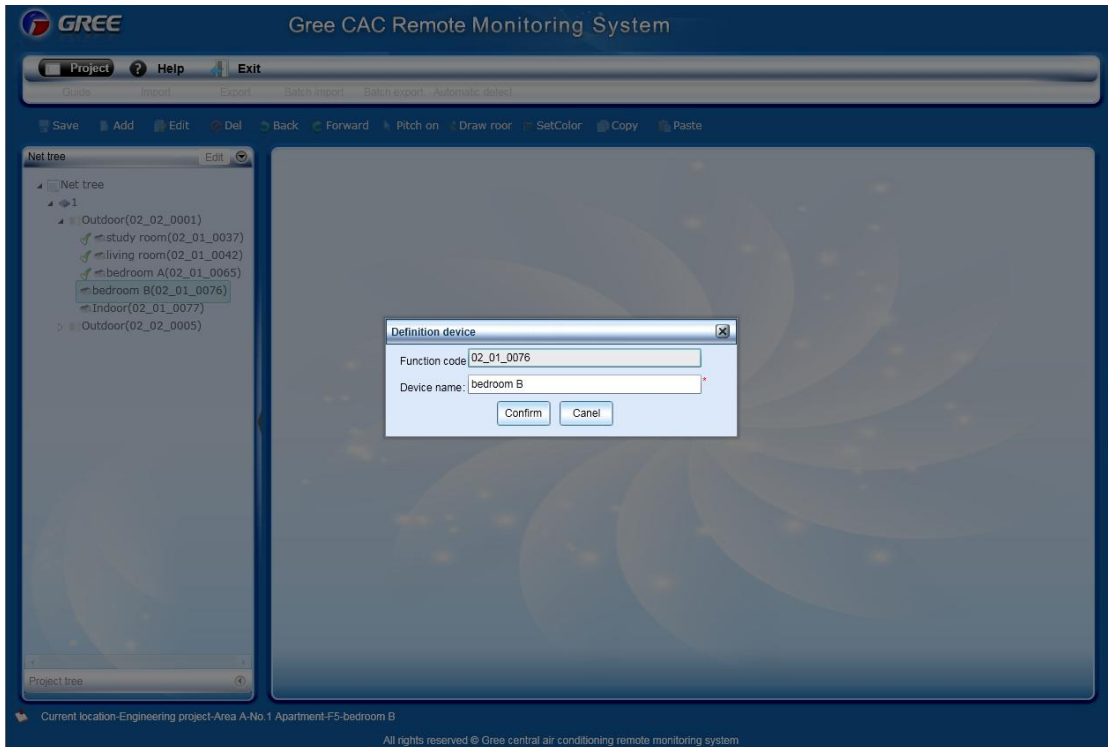



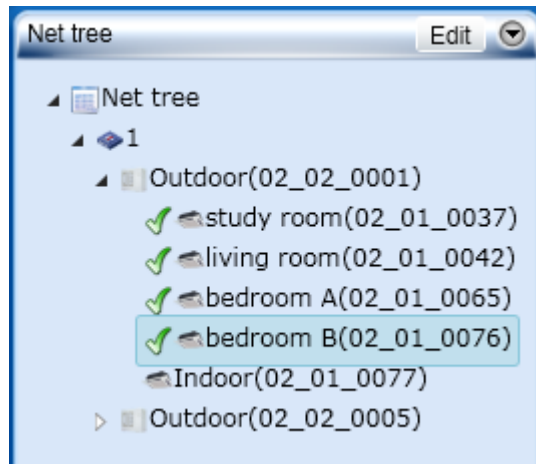

Step 8: Add the devices selected from the “Net tree” into the “Project tree”. Click the rooms in the “Project tree” one after another.



Double click a room.

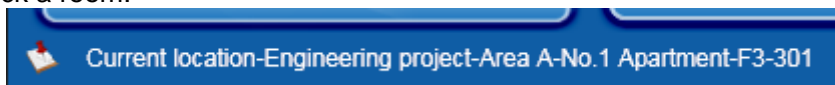

Click “Net tree” and select devices based on the air conditioner list. Drag the devices into the room.



View the devices in the “Project tree”.

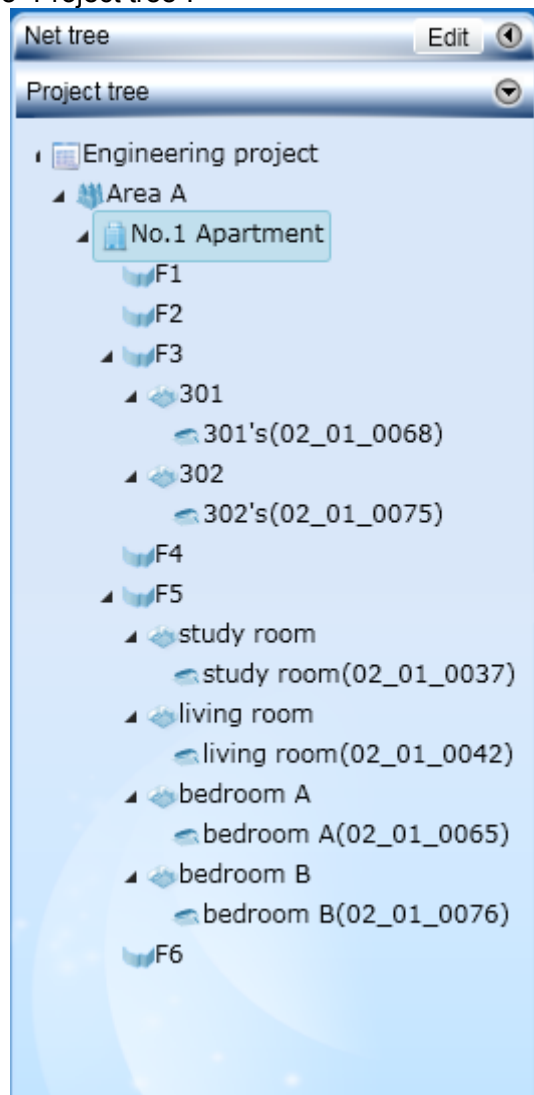

Step 9: Save the project.



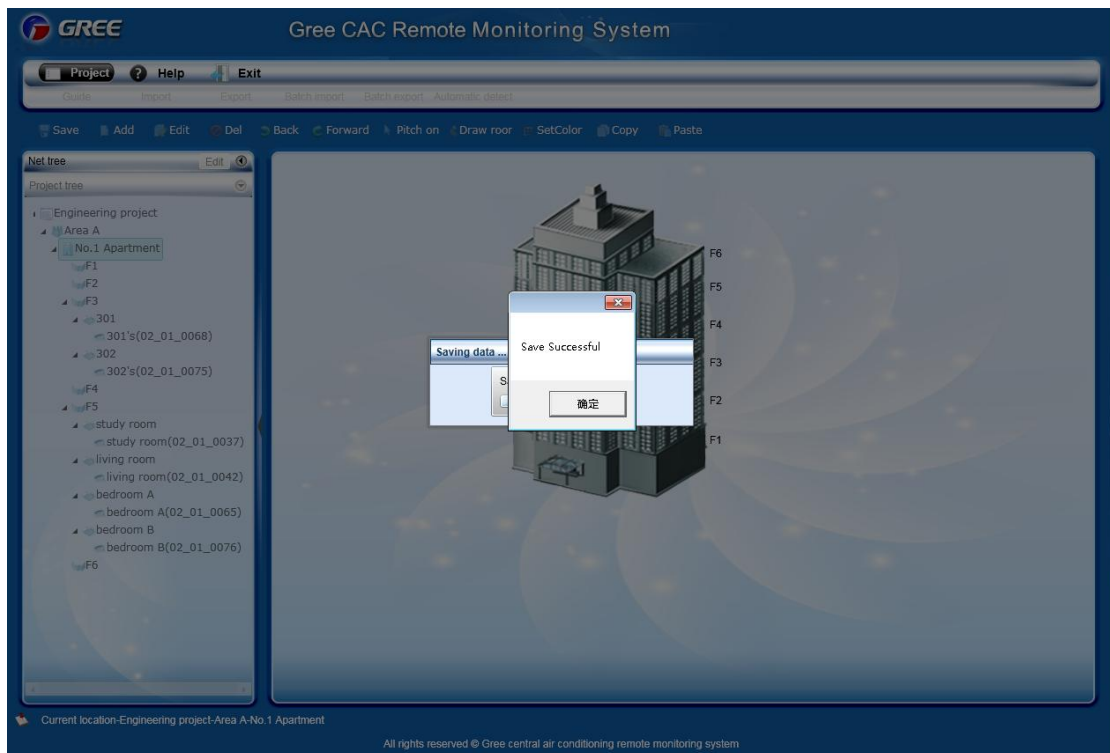

Step 10: Enter the “Visual navigation” page and you can monitor the air conditioners of the created project.

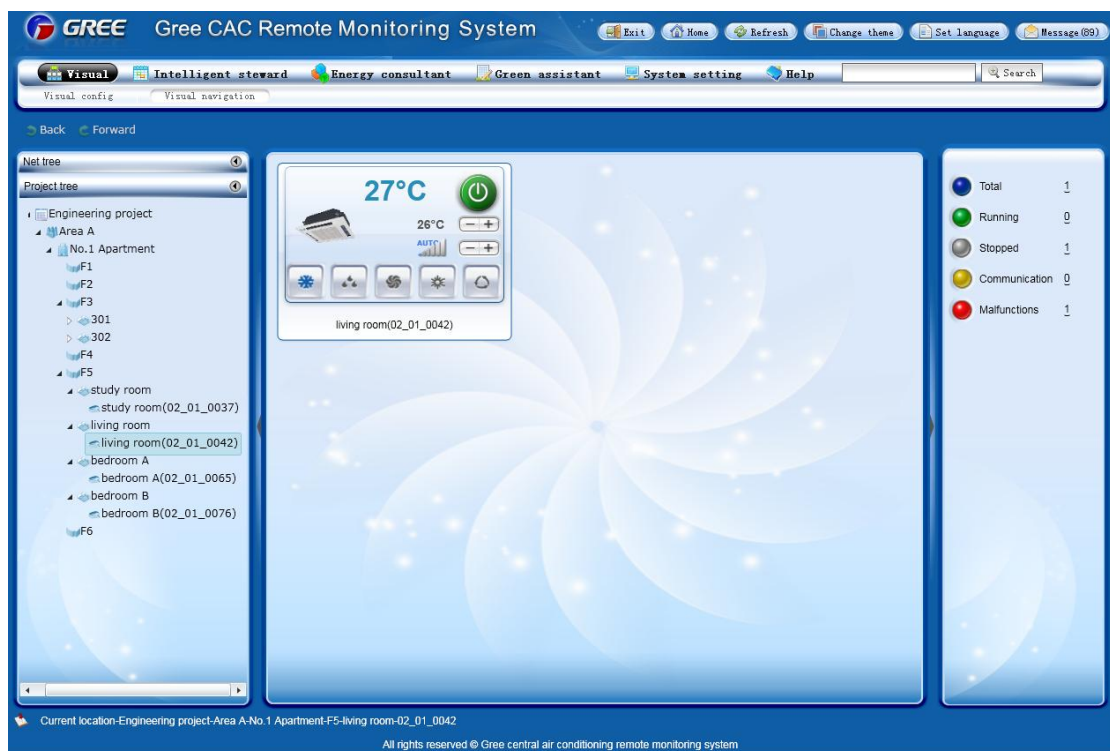

Note: The devices also can be monitored in the “Net tree” and “Intelligent steward”.

## 2.8 Troubleshooting

### 2.8.1 Hardware Faults

Symptom	Possible Cause	Troubleshooting
A software communication fault alarm is reported, and some or all units' running state is not displayed or cannot be controlled.	The communications lines are not twisted pairs.	Replace the communication lines with twisted pairs.
	Gateway damages.	Replace the damaged gateway.
	Communication lines interrupt.	Weld the interrupted lines.
	Communication lines are short circuited.	Repair the short circuited part.
	Twisted pairs are too close to the power lines (less than 15 cm clearance), resulting in disturbance that affects communication.	Separate the two types of lines. If their clearance is less than 15 cm, cover them with sheath separately.
	Communication interface connection error	Refer to related instructions to connect the communication interfaces.
Though lines are normal, a software communication fault occurs and some or all units' information is not displayed.	ODUs, after being replaced with chips or reset with DIP, are not re-powered on.	Re-power on the ODUs.
	The serial port configured by the software is inconsistent with that connected to PCs.	Connect the PCs to the serial port configured by the software or change the serial port setting in the software.
	Units are not powered on.	Power on the units.
	ODUs or IDUs are not equipped with chips, or chips are inversely installed.	Install the chips in a correct direction and power on the units.
	Unit address is incorrect or replicate.	Correct the incorrect address settings.
Though lines and devices are normal, information of devices of a floor is not displayed.	Maybe a repeater is required. If such a device has been installed, maybe wiring is incorrect.	Reinstall the repeater in a correct manner.
A communication fault alarm is reported, all units' running state is not displayed, and the TX LED on the converter is steadily on.	Polarities of communication lines are not distinguished or they are connected in a wrong order.	Check communication lines for their polarities and connect them in a correct order.
Lines, devices, and setups are all normal. However, a software communication fault alarm is reported.	The display or controller does not match units.	Check the models of the controller and operation panel. If they do not match unit specification, replace them.

### 2.8.2 Software Faults

(1) Though the username and password entered are correct, the system prompts "Please contact the administrator", as shown in the following figure:



Possible cause:

The database for the Remote Monitoring System on the server is not enabled.

Solution:

Check whether the database for the Remote Monitoring System in the server is enabled. Right click "My computer" and choose "Manage" from the shortcut menu, and choose "Services and Applications" -> "Services" to check whether the SQL Server (SQLEXPRESS) is running; if not, right click it and choose "Start". If SQL Server is not found, maybe SQL Server setup fails. Unload the software and reinstall it; or manually install SQL Server 2008 R2 and then install this software.

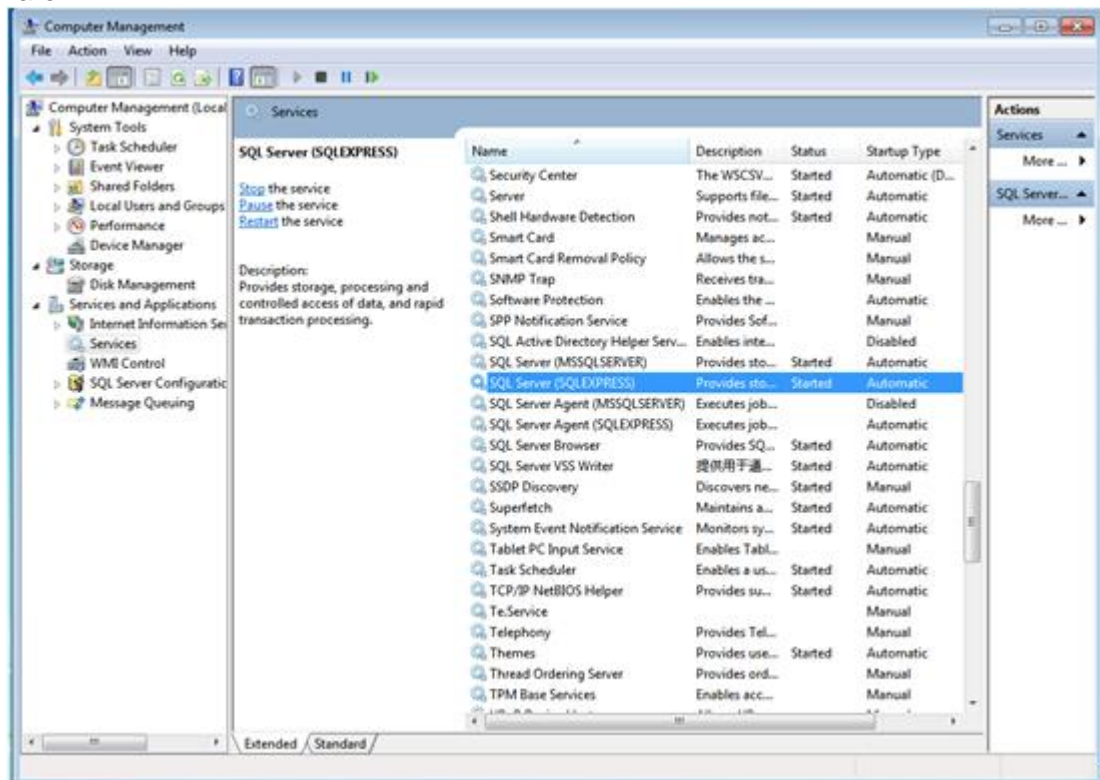

(2) During self-check, "BAS system service has been stopped" is prompted, as shown in the following figure:

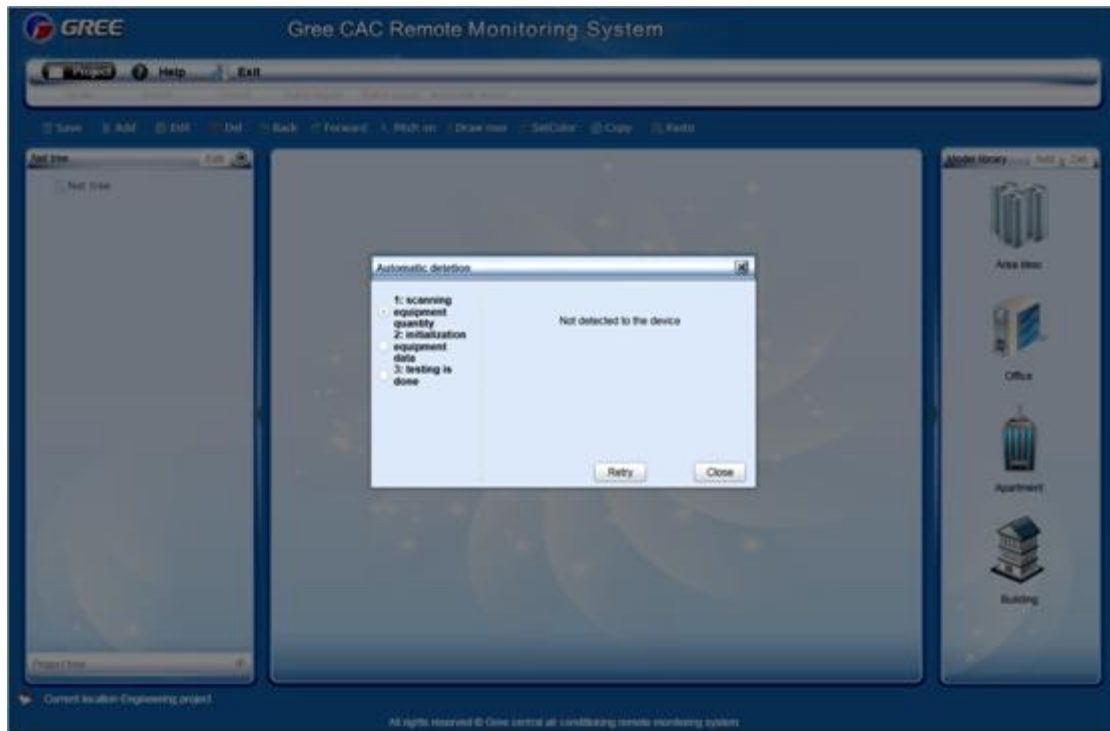

Possible cause:

Communication between the server and gateway fails.

Solution:

1) Check whether a hardware fault exists. Check gateway running. For details, refer to section 7.1 "Hardware Faults".

2) If there is not hardware fault or the fault is addressed, restart BAS Service. There are two methods to restart BAS Service.

Method a

① Right click the BAS Manager icon in the status bar at the lower right corner on the desktop and choose "Open".

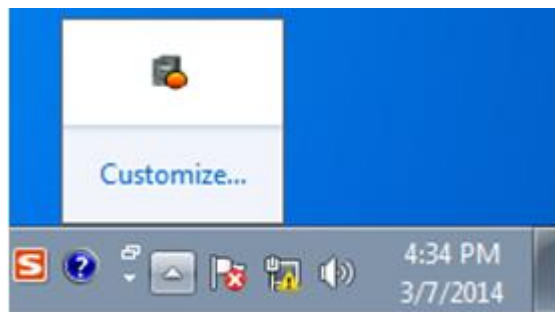

② In the displayed "BAS Manager" window, click "Start" to enable BAS Manager.

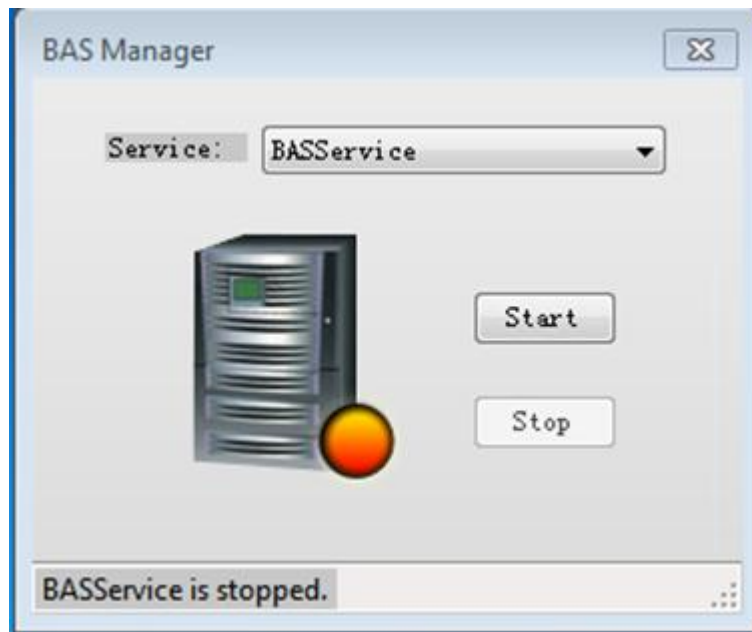

Method b

Choose "Start" -> "All Programs" -> "Gree CAC Remote Monitoring System"-> "ServiceManager". In the displayed "BAS Manager" window, click "Start" to enable BAS Manager.

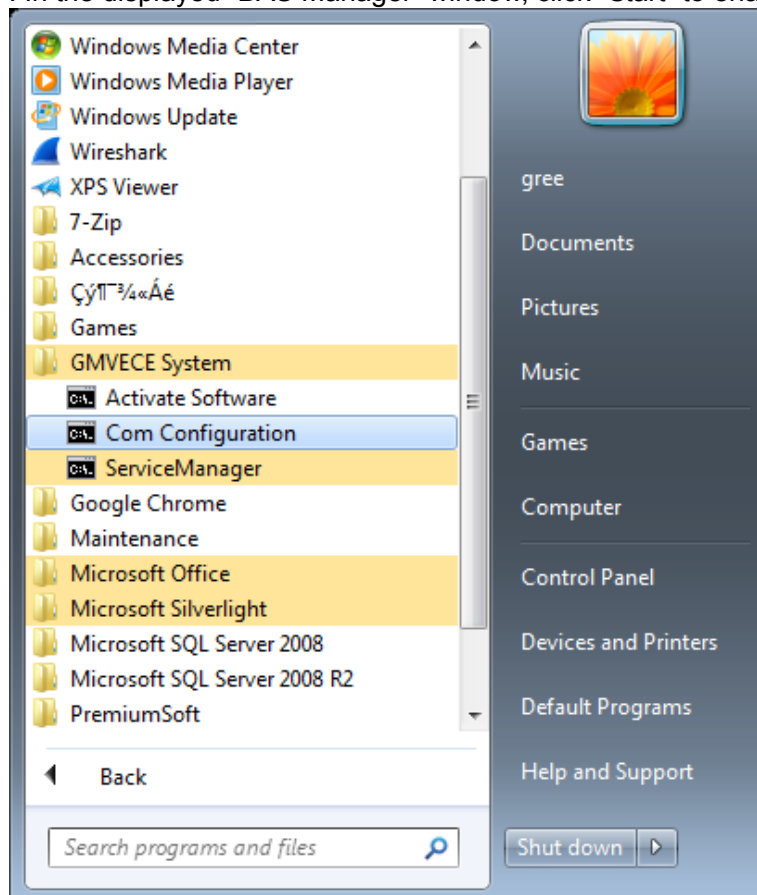

(3) During remote monitoring, services are stopped abnormally. The BAS Manager icon in the status bar at the lower right corner on the desktop becomes red.

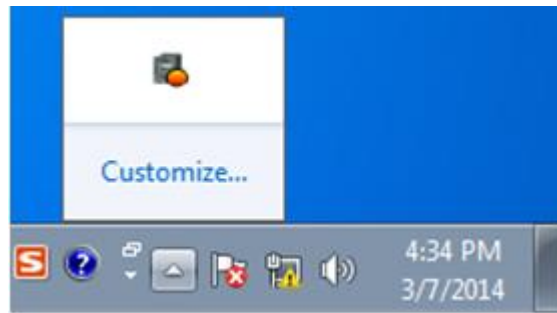

Possible cause:

Communication between the server and gateway fails.

Solution:

1) Check whether a hardware fault exists. Check gateway running. For details, refer to section 7.1 "Hardware Faults".

2) If there is not hardware fault or the fault is addressed, restart BAS Service. There are two methods to restart BAS Service.

Method a

① Right click the BAS Manager icon in the status bar at the lower right corner on the desktop and choose "Open".

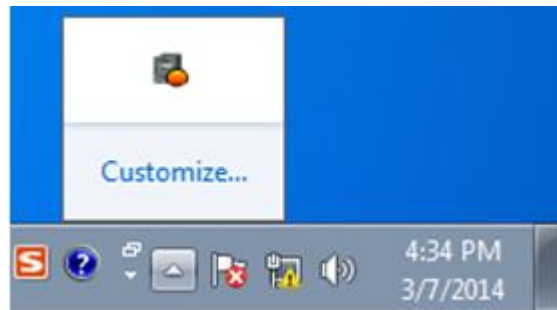

② In the displayed "BAS Manager" window, click "Start" to enable BAS Manager.

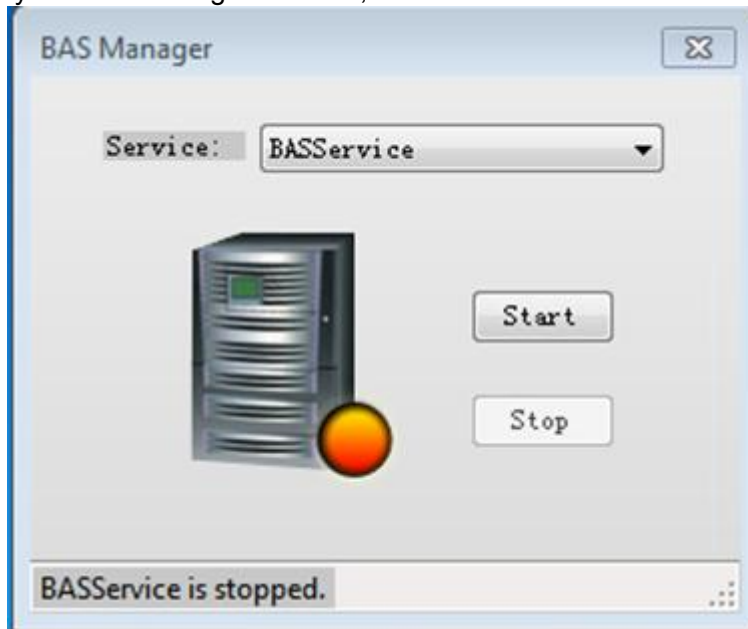

Method b

Choose "Start" -> "All Programs" -> "Gree CAC Remote Monitoring System" -> "ServiceManager". In the displayed "BAS Manager" window, click "Start" to enable BAS Manager.

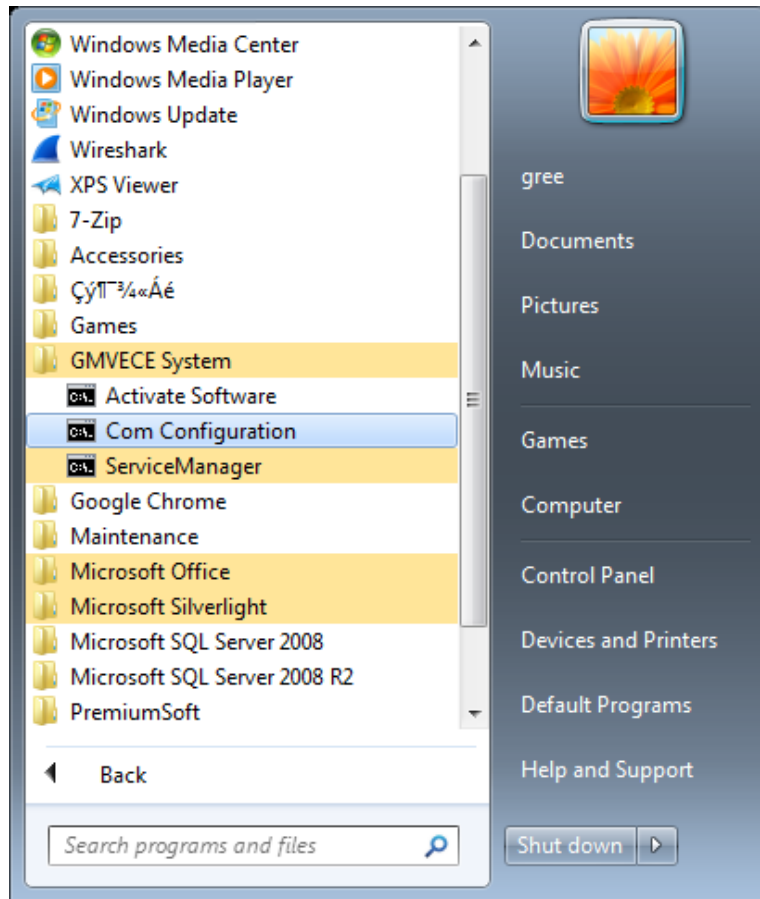

(4) After the server IP address is entered through IE on the client, "Internet Explorer cannot display the webpage" is prompted, as shown in the following figure:

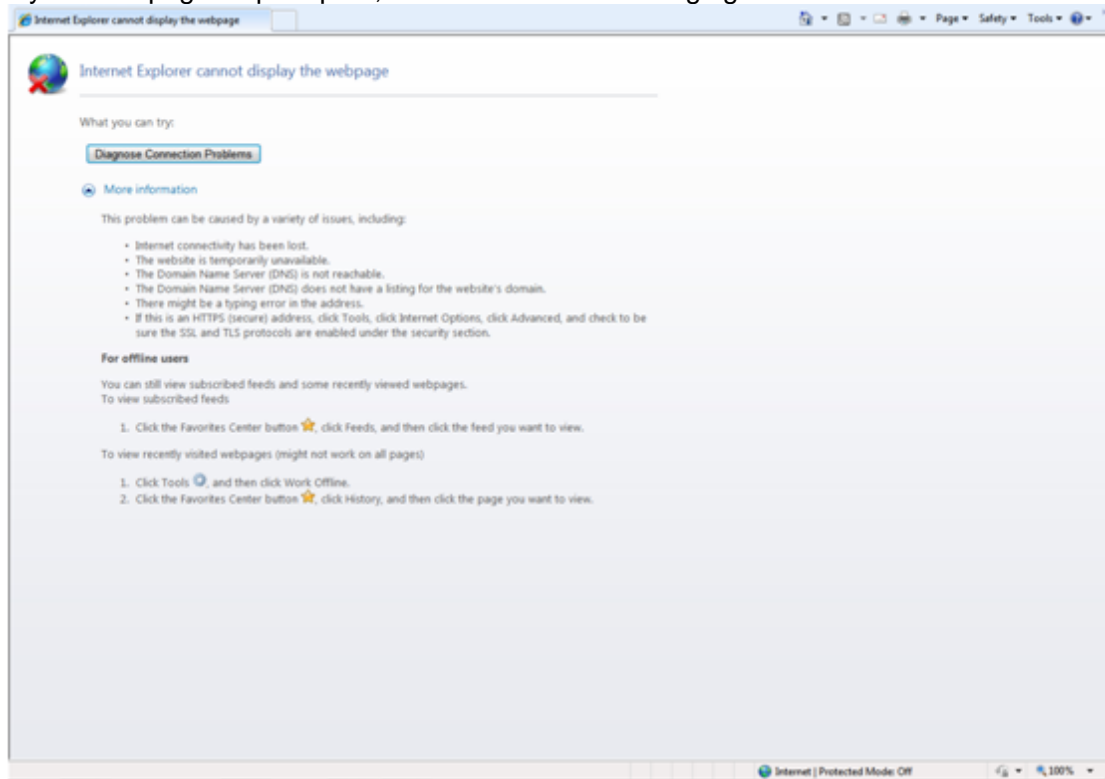

Possible causes:

The server is not started.

Network line of the server or the client is not properly connected.

Server or client network is faulty, causing server access to fail.

The IIS manager in the server abnormally disables the website.

Solution:



- 1) Check whether the server is started.
  - 2) Check the network line of the server and client for looseness or damage.
  - 3) Check the network adapter of the server and client for looseness or damage; and check whether “Local connect” is enabled.
  - 4) If the problem persists, ping the server or the client.
- The ping procedure is as follows:

① Choose “Start” -> “Run”. The “Run” window is displayed. Enter “cmd” in the text box and click “OK”.

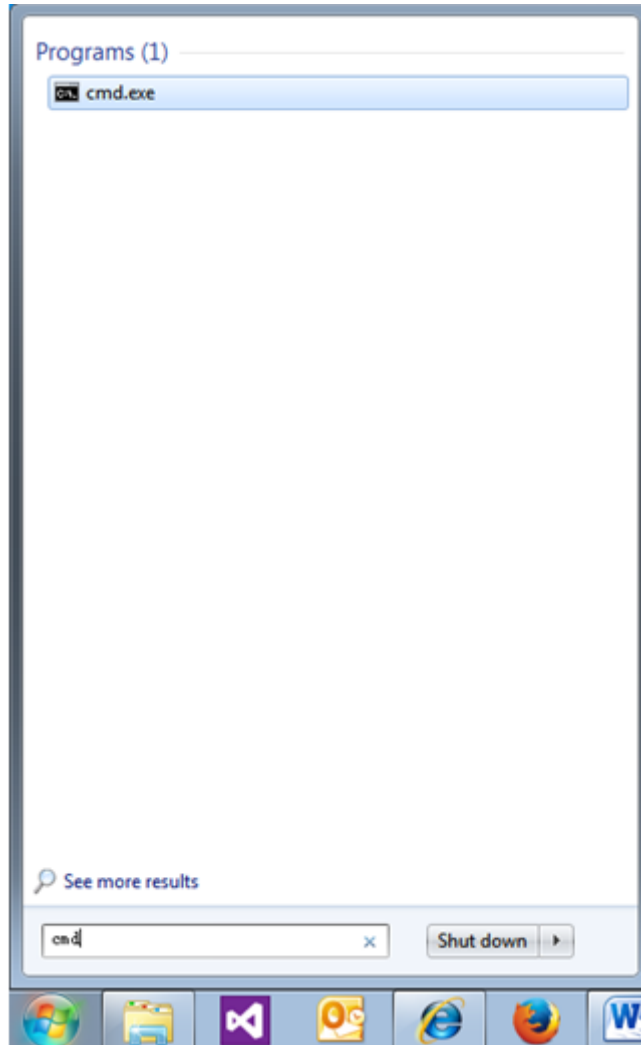

② In the displayed “cmd.exe” window, enter the IP address of the PC to be pinged through, for example “Ping 192.168.0.122”, if the following information is shown, the system can be used.

```
Administrator: F:\Windows\system32\cmd.exe
Microsoft Windows [Version 6.1.7600]
Copyright (c) 2009 Microsoft Corporation. All rights reserved.

F:\Users\Administrator>ping 192.168.0.122

Pinging 192.168.0.122 with 32 bytes of data:
Request timed out.
Reply from 192.168.0.122: bytes=32 time<1ms TTL=254
Reply from 192.168.0.122: bytes=32 time<1ms TTL=254
Reply from 192.168.0.122: bytes=32 time=2ms TTL=254

Ping statistics for 192.168.0.122:
    Packets: Sent = 4, Received = 3, Lost = 1 (25% loss),
    Approximate round trip times in milli-seconds:
        Minimum = 0ms, Maximum = 2ms, Average = 0ms

F:\Users\Administrator>
```

If the following timeout information is displayed, network fails. Check network information.



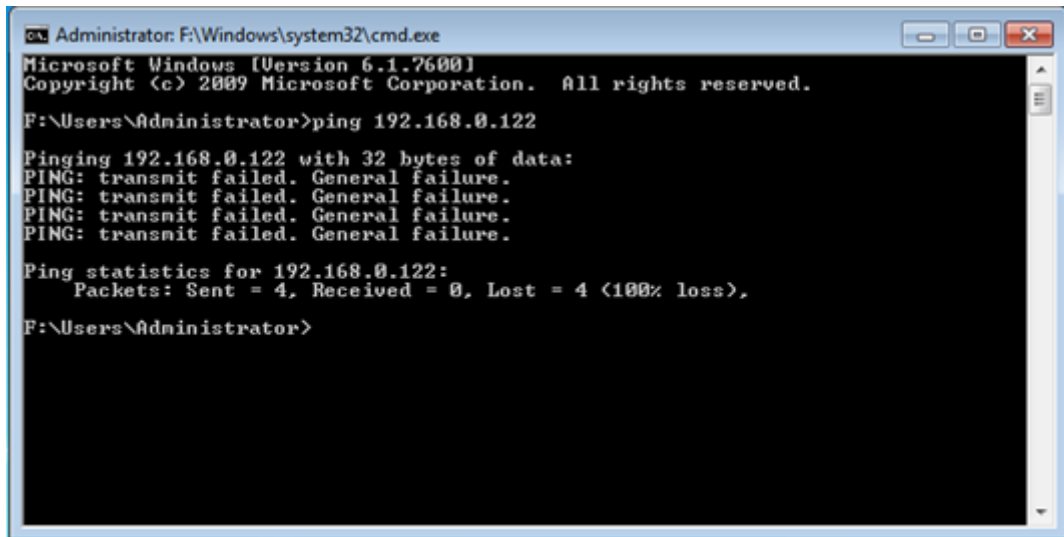

```
Administrator: F:\Windows\system32\cmd.exe
Microsoft Windows [Version 6.1.7600]
Copyright (c) 2009 Microsoft Corporation. All rights reserved.

F:\Users\Administrator>ping 192.168.0.122

Pinging 192.168.0.122 with 32 bytes of data:
PING: transmit failed. General failure.
PING: transmit failed. General failure.
PING: transmit failed. General failure.
PING: transmit failed. General failure.

Ping statistics for 192.168.0.122:
    Packets: Sent = 4, Received = 0, Lost = 4 (100% loss),

F:\Users\Administrator>
```

5) If network is available but the client still cannot access the server website, you need to open the IIS manager.

① Choose “Start” -> “All Programs” -> “Manage Tools” -> “IIS Manager”, as shown in the following figure:

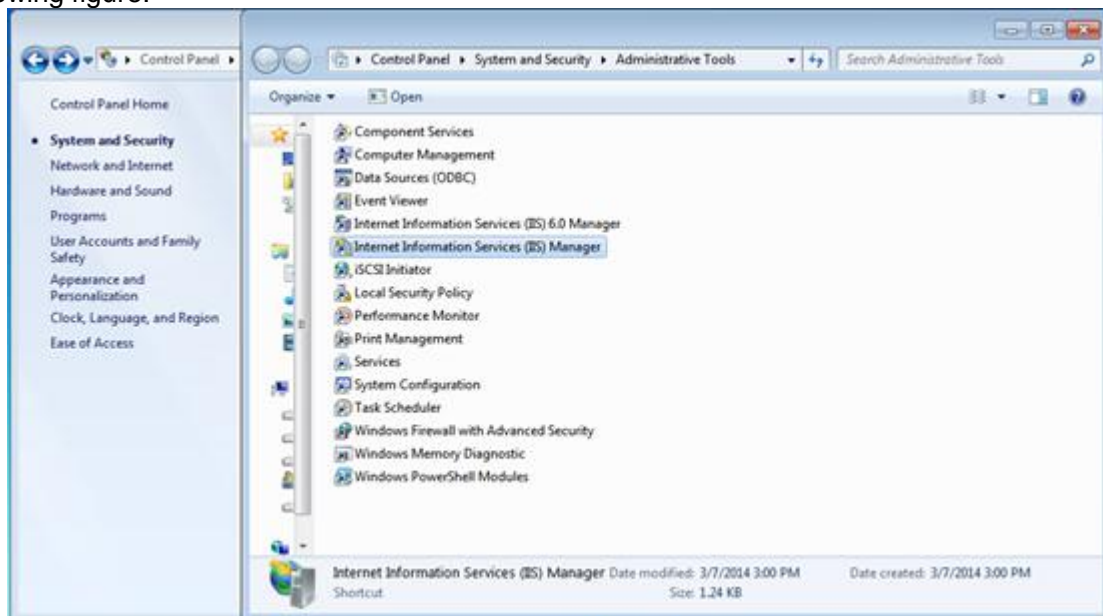

② In the displayed “IIS Manager” window, open the navigation tree in the left, choose “Website” -> “Default website”, and right click it to choose “Start” to enable the website.

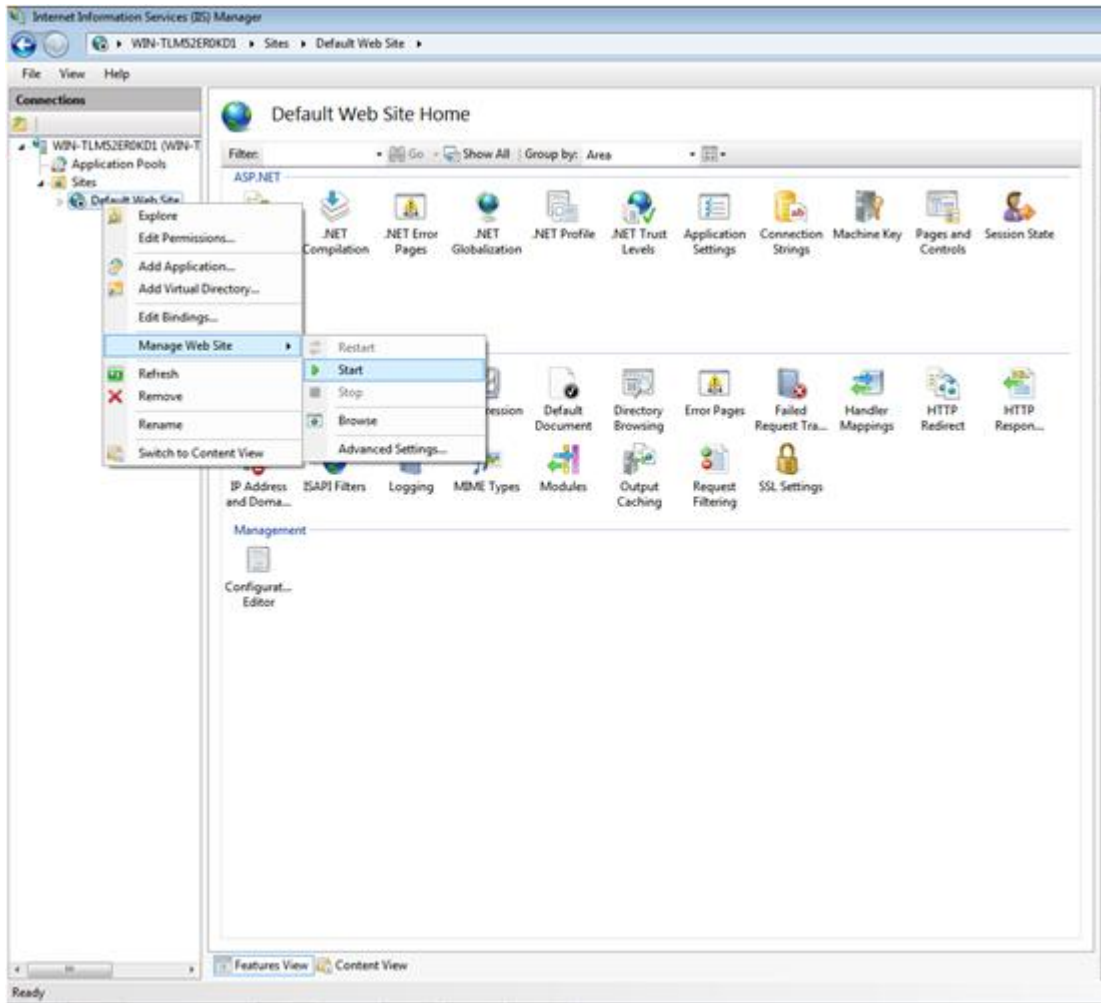



**JF00302751**

**GREE ELECTRIC APPLIANCES, INC. OF ZHUHAI**

Add: West Jinji Rd, Qianshan, Zhuhai, Guangdong, China, 519070

Tel: (+86-756) 8522218 Fax: (+86-756) 8669426

E-mail: [gree@gree.com.cn](mailto:gree@gree.com.cn) [www.gree.com](http://www.gree.com)

For continuous improvement in the products, Gree reserves the right to modify the product specification and appearance in this manual without notice and without incurring any obligations.